

GA400TD25S

"HALF-BRIDGE" IGBT DUAL INT-A-PAK

Standard Speed IGBT

Features

- Generation 4 IGBT technology
- Standard: Optimized for minimum saturation voltage and operating frequencies up to 10kHz
- Very low conduction and switching losses
- HEXFRED™ antiparallel diodes with ultra- soft recovery
- Industry standard package
- UL approved

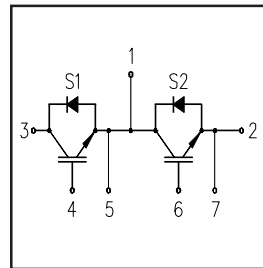

$V_{CES} = 250V$
$V_{CE(on) typ.} = 1.3V$
@ $V_{GE} = 15V, I_C = 400A$

Benefits

- Increased operating efficiency
- Direct mounting to heatsink
- Performance optimized for power conversion: UPS, SMPS, Welding
- Lower EMI, requires less snubbing

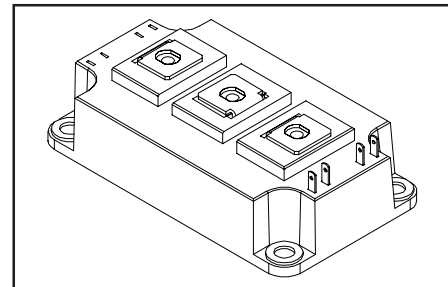

Absolute Maximum Ratings

	Parameter	Max.	Units
V_{CES}	Collector-to-Emitter Voltage	250	V
$I_C @ T_C = 25^\circ C$	Continuous Collector Current	400	A
I_{CM}	Pulsed Collector Current ^①	800	
I_{LM}	Peak Switching Current ^②	800	
I_{FM}	Peak Diode Forward Current	800	
V_{GE}	Gate-to-Emitter Voltage	± 20	V
V_{ISOL}	RMS Isolation Voltage, Any Terminal To Case, $t = 1 \text{ min}$	2500	
$P_D @ T_C = 25^\circ C$	Maximum Power Dissipation	1350	W
$P_D @ T_C = 85^\circ C$	Maximum Power Dissipation	700	
T_J	Operating Junction Temperature Range	-40 to +150	$^\circ C$
T_{STG}	Storage Temperature Range	-40 to +125	

Thermal / Mechanical Characteristics

	Parameter	Typ.	Max.	Units
$R_{\theta JC}$	Thermal Resistance, Junction-to-Case - IGBT	—	0.09	$^\circ C/W$
$R_{\theta JC}$	Thermal Resistance, Junction-to-Case - Diode	—	0.20	
$R_{\theta CS}$	Thermal Resistance, Case-to-Sink - Module	0.1	—	
	Mounting Torque, Case-to-Heatsink ^③	—	6.0	N·m
	Mounting Torque, Case-to-Terminal 1, 2 & 3 ^③	—	5.0	
	Weight of Module	400	—	g

Electrical Characteristics @ $T_J = 25^\circ\text{C}$ (unless otherwise specified)

	Parameter	Min.	Typ.	Max.	Units	Conditions
$V_{(BR)CES}$	Collector-to-Emitter Breakdown Voltage	250	—	—	V	$V_{GE} = 0V, I_C = 1mA$
$V_{CE(on)}$	Collector-to-Emitter Voltage	—	1.3	1.6		$V_{GE} = 15V, I_C = 400A$
		—	1.3	—		$V_{GE} = 15V, I_C = 400A, T_J = 125^\circ\text{C}$
$V_{GE(th)}$	Gate Threshold Voltage	3.0	—	6.0		$I_C = 3.0mA$
$\Delta V_{GE(th)}/\Delta T_J$	Temperature Coeff. of Threshold Voltage	—	-11	—	mV/°C	$V_{CE} = V_{GE}, I_C = 2.5mA$
g_{fe}	Forward Transconductance ^④	—	371	—	S	$V_{CE} = 25V, I_C = 400A$
I_{CES}	Collector-to-Emitter Leaking Current	—	—	0.50	mA	$V_{GE} = 0V, V_{CE} = 250V$
		—	—	20		$V_{GE} = 0V, V_{CE} = 250V, T_J = 125^\circ\text{C}$
V_{FM}	Diode Forward Voltage - Maximum	—	1.7	2.2	V	$I_F = 500A, V_{GE} = 0V$
		—	1.7	—		$I_F = 500A, V_{GE} = 0V, T_J = 125^\circ\text{C}$
I_{GES}	Gate-to-Emitter Leakage Current	—	—	500	nA	$V_{GE} = \pm 20V$

Dynamic Characteristics - $T_J = 125^\circ\text{C}$ (unless otherwise specified)

	Parameter	Min.	Typ.	Max.	Units	Conditions
Q_g	Total Gate Charge (turn-on)	—	1600	2400	nC	$V_{CC} = 200V$
Q_{ge}	Gate - Emitter Charge (turn-on)	—	232	348		$I_C = 440A$
Q_{gc}	Gate - Collector Charge (turn-on)	—	528	792		$T_J = 25^\circ\text{C}$
$t_{d(on)}$	Turn-On Delay Time	—	1250	—	ns	$R_{G1} = 15\Omega, R_{G2} = 0\Omega,$
t_r	Rise Time	—	365	—		$I_C = 400A$
$t_{d(off)}$	Turn-Off Delay Time	—	841	—		$V_{CC} = 150V$
t_f	Fall Time	—	792	—		$V_{GE} = \pm 15V$
E_{on}	Turn-On Switching Energy	—	6.0	—	mJ	See Fig.17 through Fig.21
E_{off}	Turn-Off Switching Energy	—	38	—		
E_{ts}	Total Switching Energy	—	45	52		
C_{ies}	Input Capacitance	—	36000	—	pF	$V_{GE} = 0V$
C_{oes}	Output Capacitance	—	4080	—		$V_{CC} = 30V$
C_{res}	Reverse Transfer Capacitance	—	800	—		$f = 1\text{ MHz}$
t_{rr}	Diode Reverse Recovery Time	—	229	—	ns	$I_C = 400A$
I_{rr}	Diode Peak Reverse Current	—	71	—		$R_{G1} = 15\Omega$
Q_{rr}	Diode Recovery Charge	—	8154	—	nC	$R_{G2} = 0\Omega$
$di_{(rec)}/dt$	Diode Peak Rate of Fall of Recovery During t_b	—	911	—		$V_{CC} = 150V$ $di/dt \gg 1400A/\mu s$

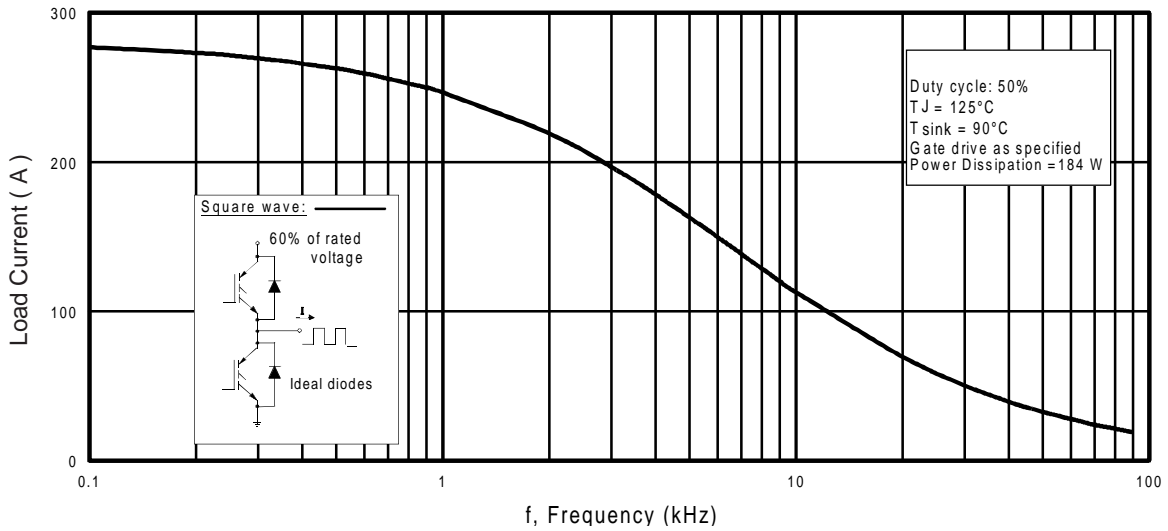

Fig. 1 - Typical Load Current vs. Frequency
(Load Current = I_{RMS} of fundamental)

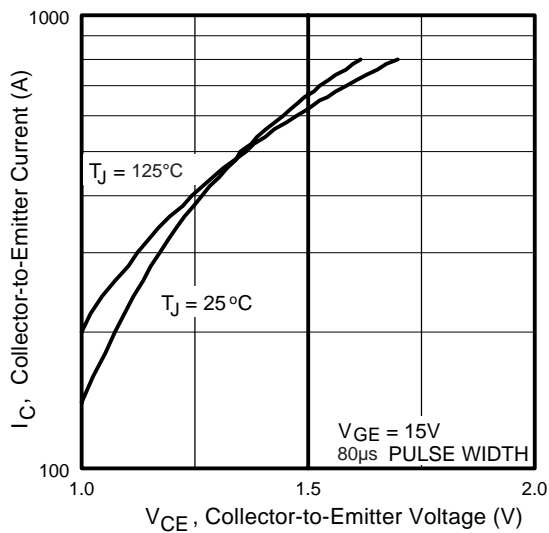

Fig. 2 - Typical Output Characteristics

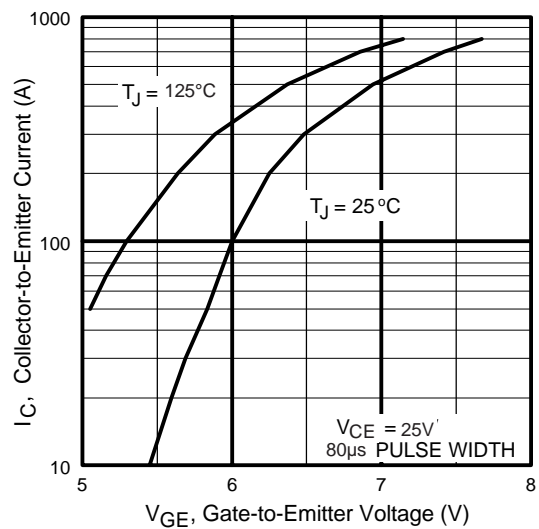

Fig. 3 - Typical Transfer Characteristics

GA400TD25S

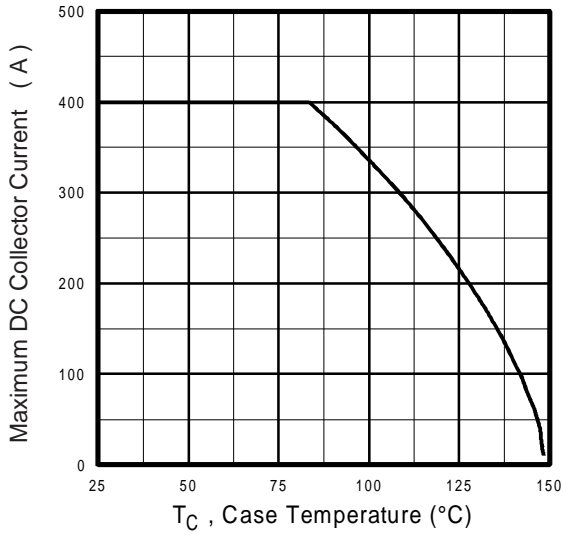

Fig. 4 - Maximum Collector Current vs. Case Temperature

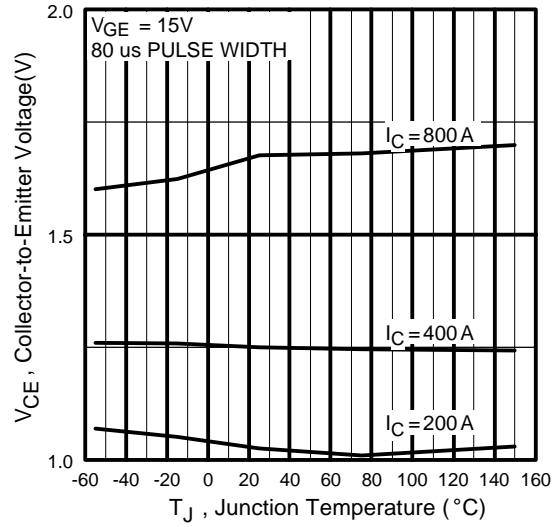

Fig. 5 - Typical Collector-to-Emitter Voltage vs. Junction Temperature

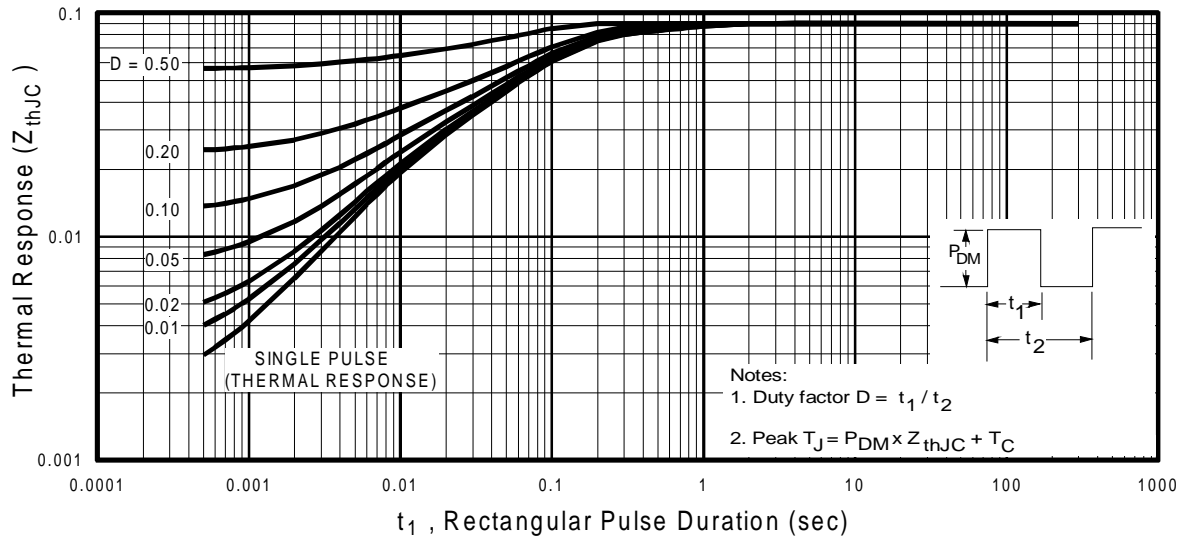

Fig. 6 - Maximum Effective Transient Thermal Impedance, Junction-to-Case

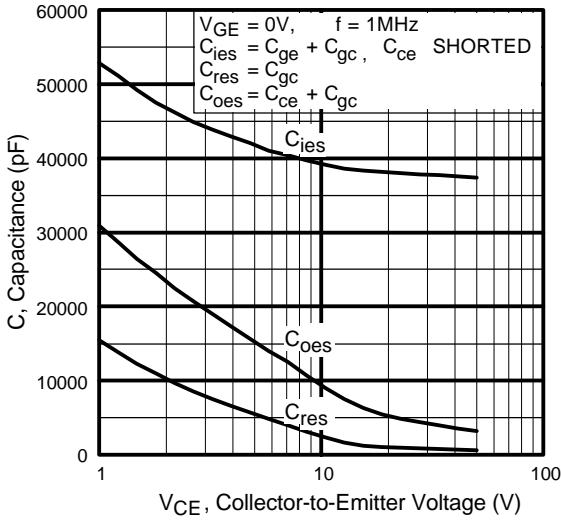

Fig. 7 - Typical Capacitance vs. Collector-to-Emitter Voltage

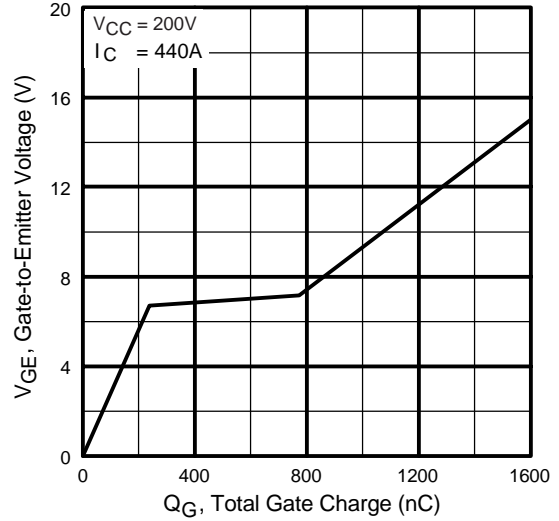

Fig. 8 - Typical Gate Charge vs. Gate-to-Emitter Voltage

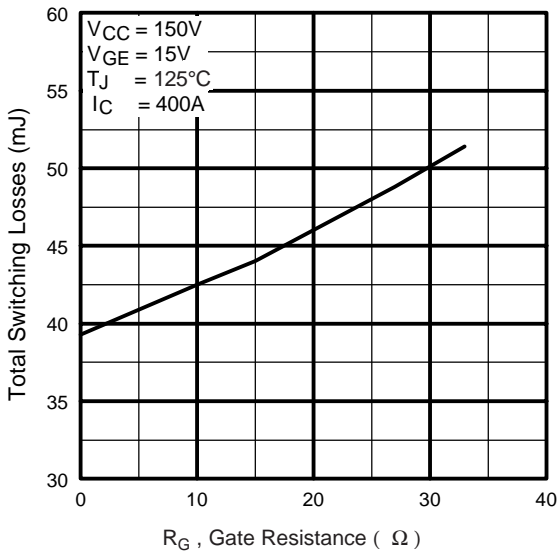

Fig. 9 - Typical Switching Losses vs. Gate Resistance

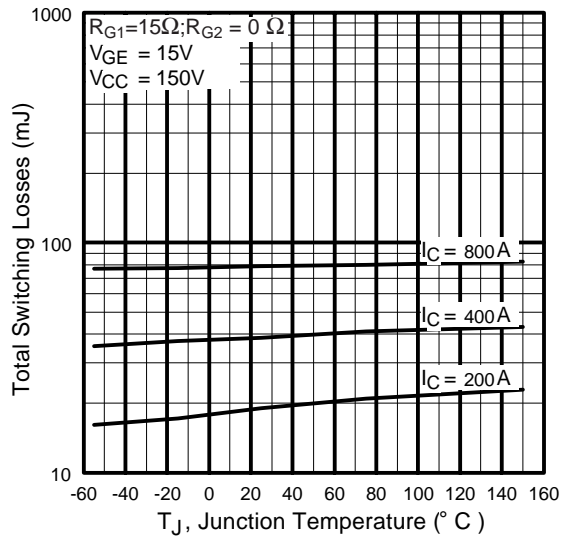

Fig. 10 - Typical Switching Losses vs. Junction Temperature

GA400TD25S

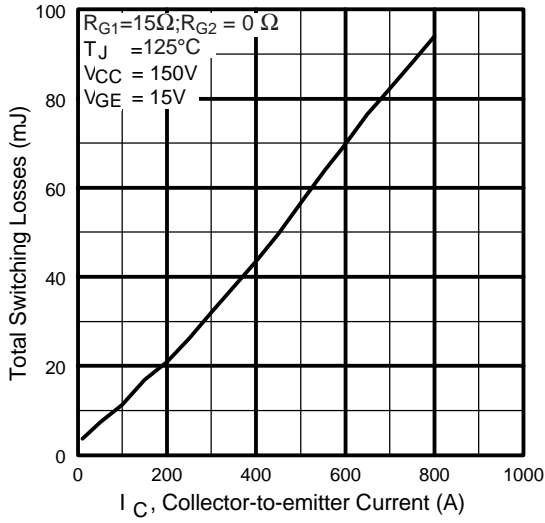

Fig. 11 - Typical Switching Losses vs. Collector-to-Emitter Current

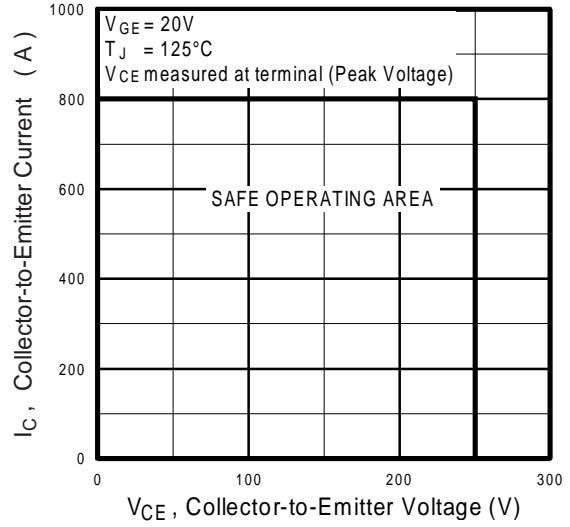

Fig. 12 - Reverse Bias SOA

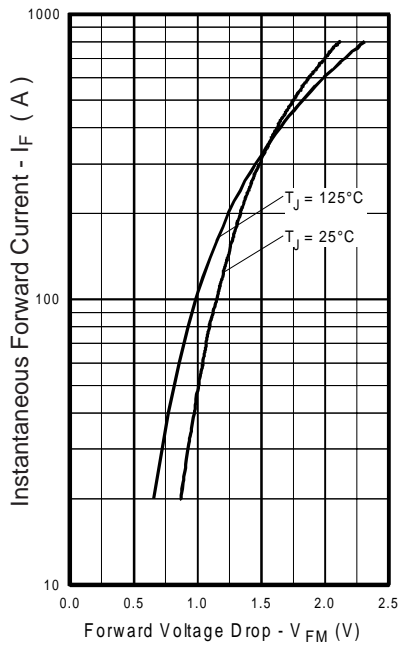

Fig. 13 - Typical Forward Voltage Drop vs. Instantaneous Forward Current

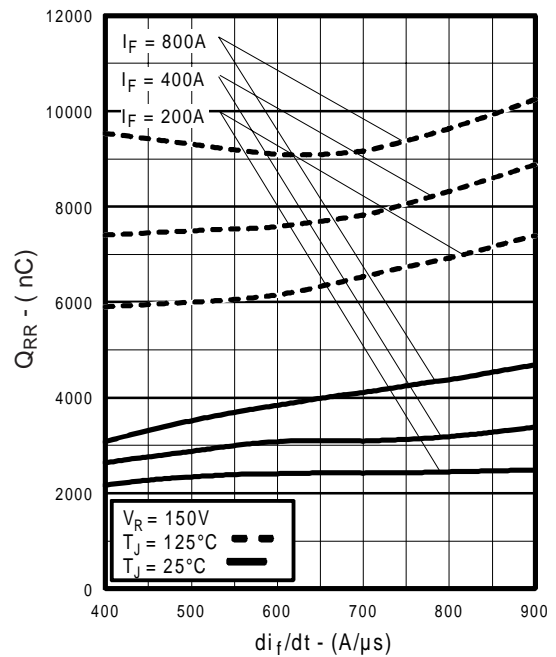

Fig. 14 - Typical Stored Charge vs. di_f/dt

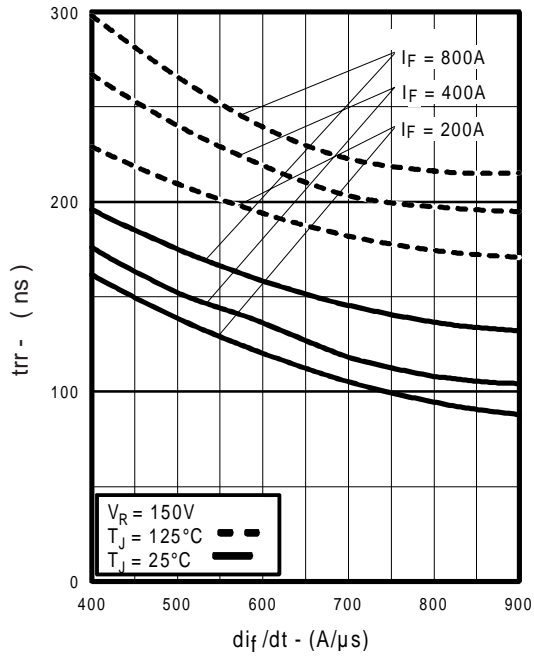

Fig. 15 - Typical Reverse Recovery vs. di_f/dt

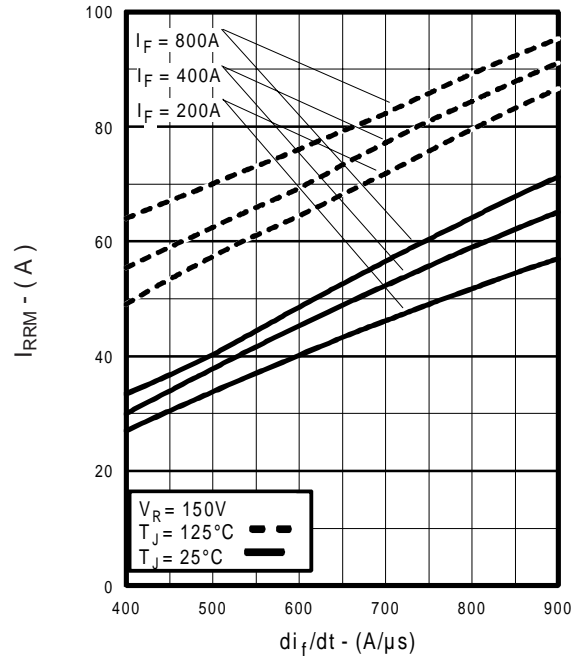

Fig. 16 - Typical Recovery Current vs. di_f/dt

GA400TD25S

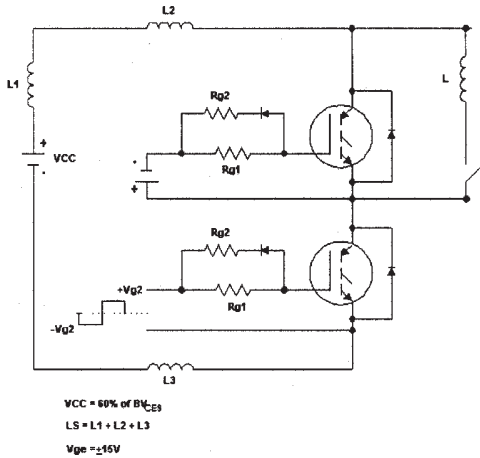

Fig. 17 - Test Circuit for Measurement of I_{LM} , E_{on} , $E_{off}(\text{diode})$, t_{rr} , Q_{rr} , I_{rr} , $t_{d(on)}$, t_r , $t_{d(off)}$, t_f

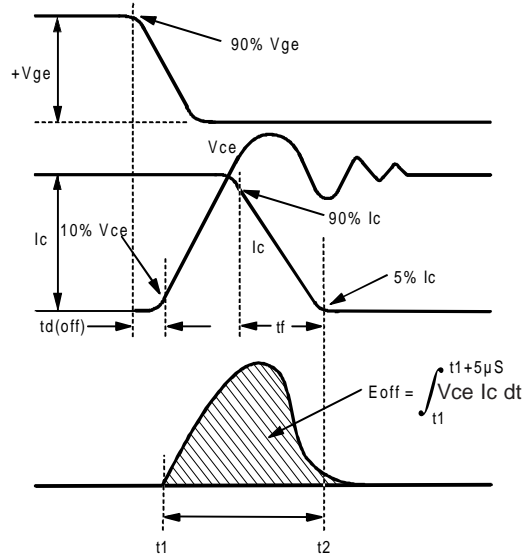

Fig. 18 - Test Waveforms for Circuit of Fig. 17, Defining E_{off} , $t_{d(off)}$, t_f

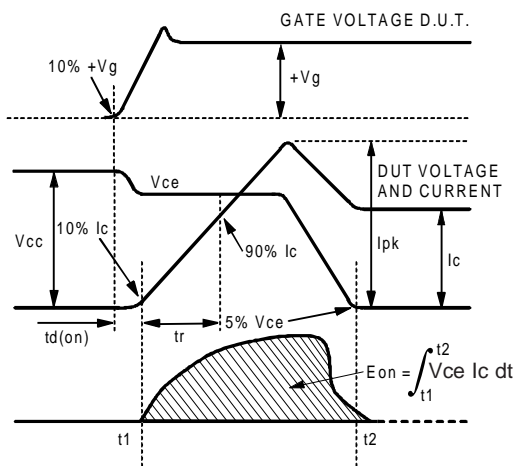

Fig. 19 - Test Waveforms for Circuit of Fig. 17, Defining E_{on} , $t_{d(on)}$, t_r

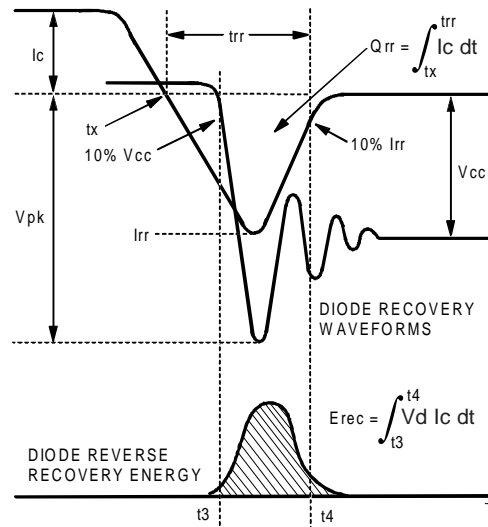

Fig. 20 - Test Waveforms for Circuit of Fig. 17, Defining E_{rec} , t_{rr} , Q_{rr} , I_{rr}

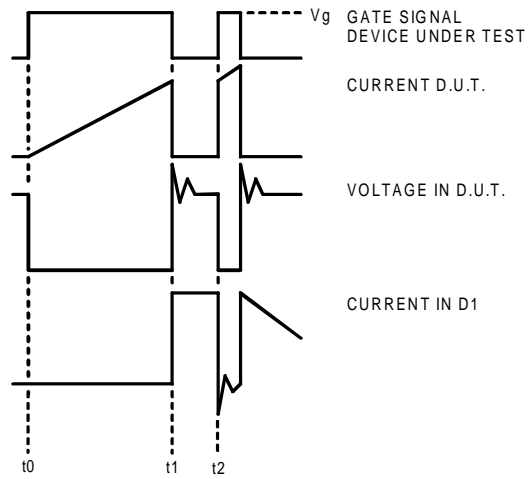

Figure 21. Macro Waveforms for Figure 17's Test Circuit

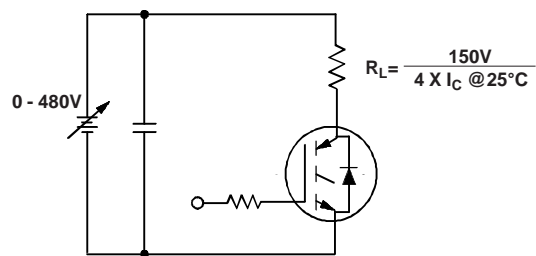

Figure 22. Pulsed Collector Current
 Test Circuit

GA400TD25S

International
IR Rectifier

Notes:

- ① Repetitive rating; $V_{GE} = 20V$, pulse width limited by max. junction temperature.
- ② See fig. 17
- ③ For screws M6.
- ④ Pulse width $80\mu s$; single shot.

Case Outline — DUAL INT-A-PAK

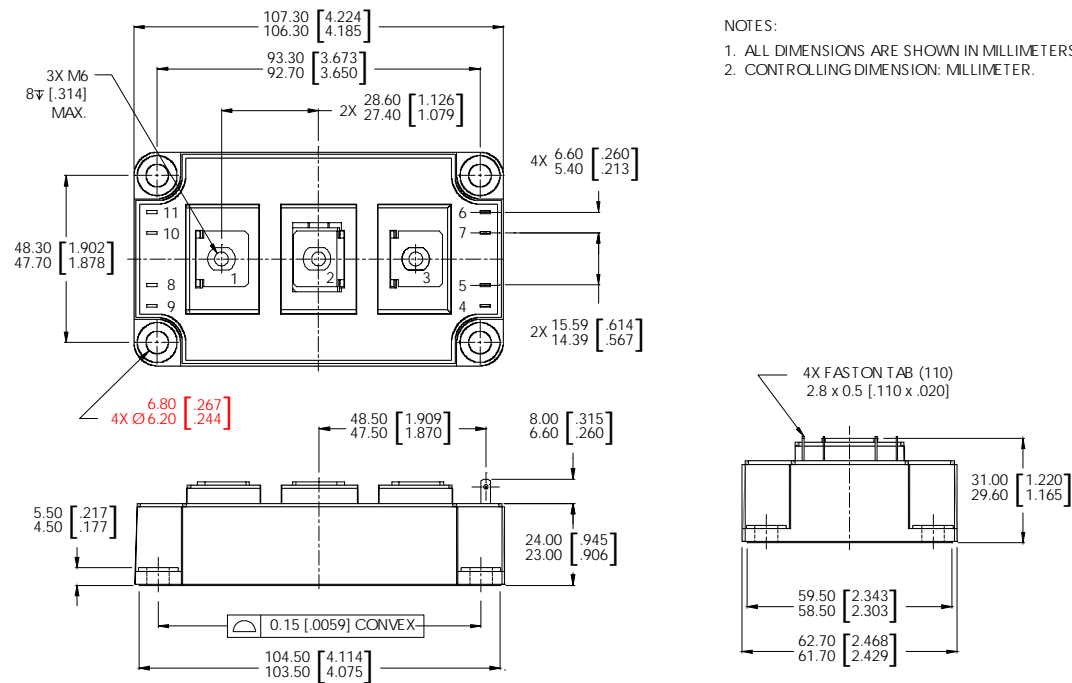

NOTES:

1. ALL DIMENSIONS ARE SHOWN IN MILLIMETERS (INCHES).
2. CONTROLLING DIMENSION: MILLIMETER.

Data and specifications subject to change without notice.
This product has been designed and qualified for the Industrial market.
Qualification Standards can be found on IR's Web site.

International
IR Rectifier

IR WORLD HEADQUARTERS: 233 Kansas St., El Segundo, California 90245, USA Tel: (310) 252-7105
TAC Fax: (310) 252-7903

Visit us at www.irf.com for sales contact information.05/02

www.irf.com