

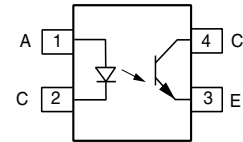

## Optocoupler, Phototransistor Output, SOP-4, Mini-Flat Package

### Features

- SOP (Small Outline Package)
- Isolation Test Voltage, 3750 V<sub>RMS</sub> (1.0 s)
- High Collector-Emitter Breakdown Voltage, V<sub>CEO</sub> = 70 V
- Low Saturation Voltage
- Fast Switching Times
- Temperature Stable
- Low Coupling Capacitance
- End-Stackable, .100 " (2.54 mm) Spacing
- Lead-free component
- Component in accordance to RoHS 2002/95/EC and WEEE 2002/96/EC

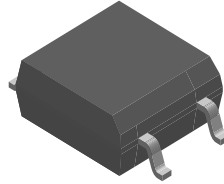

1179065



### Agency Approvals

- UL1577, File No. E52744 System Code U
- CSA 93751
- BSI IEC60950 IEC60065

### Applications

High density mounting or space sensitive PCBs  
 PLCs  
 Telecommunication

### Description

The SFH690ABT/ AT/ BT/ CT family has a GaAs infrared emitting diode emitter, which is optically coupled to a silicon planar phototransistor detector, and is incorporated in a 4-pin 100 mil lead pitch miniflat package. It features a high current transfer ratio, low coupling capacitance, and high isolation voltage.

The coupling devices are designed for signal transmission between two electrically separated circuits. The SFH690 series is available only on tape and reel. There are 2000 parts per reel. Marking for SFH690AT is SFH690A; SFH690BT is SFH690B; SFH690CT is SFH690C; SFH690ABT will be marked as SFH690A or SFH690B.

### Order Information

Part	Remarks
SFH690ABT	CTR 50 - 300 %, SMD-4
SFH690AT	CTR 50 - 150 %, SMD-4
SFH690BT	CTR 100 - 300 %, SMD-4
SFH690CT	CTR 100 - 200 %, SMD-4

For additional information on the available options refer to Option Information.

### Absolute Maximum Ratings

T<sub>amb</sub> = 25 °C, unless otherwise specified

Stresses in excess of the absolute Maximum Ratings can cause permanent damage to the device. Functional operation of the device is not implied at these or any other conditions in excess of those given in the operational sections of this document. Exposure to absolute Maximum Rating for extended periods of the time can adversely affect reliability.

### Input

Parameter	Test condition	Symbol	Value	Unit
Reverse voltage		V <sub>R</sub>	6.0	V
DC Forward current		I <sub>F</sub>	50	mA
Surge forward current	t <sub>p</sub> ≤ 10 μs	I <sub>FSM</sub>	2.5	A
Power dissipation		P <sub>diss</sub>	80	mW

### Output

Parameter	Test condition	Symbol	Value	Unit
Collector-emitter voltage		$V_{CE}$	70	V
Emitter-collector voltage		$V_{EC}$	7.0	V
Collector current		$I_C$	50	mA
	$t_p \leq 1.0$ ms	$I_C$	100	mA
Power dissipation		$P_{diss}$	150	mW

### Coupler

Parameter	Test condition	Symbol	Value	Unit
Isolation test voltage between emitter and detector (1.0 s)		$V_{ISO}$	3750	$V_{RMS}$
Creepage			$\geq 5.33$	mm
Clearance			$\geq 5.08$	mm
Insulation thickness between emitter and detector			$\geq 0.4$	mm
Comparative tracking index per DIN IEC 112/VDEO 0303, part 1			$\geq 175$	
Isolation resistance	$V_{IO} = 500$ V, $T_{amb} = 25$ °C	$R_{IO}$	$\geq 10^{12}$	$\Omega$
	$V_{IO} = 500$ V, $T_{amb} = 100$ °C	$R_{IO}$	$\geq 10^{11}$	$\Omega$
Storage temperature range		$T_{stg}$	- 55 to + 150	°C
Ambient temperature range		$T_{amb}$	- 55 to + 100	°C
Junction temperature		$T_j$	100	°C
Soldering temperature	max. 10 s Dip soldering distance to seating plane $\geq 1.5$ mm	$T_{sld}$	260	°C

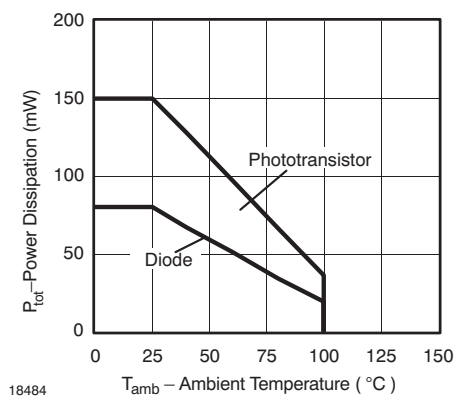

Figure 1. Permissible Power Dissipation vs. Ambient Temperature



## Electrical Characteristics

$T_{amb} = 25\text{ }^{\circ}\text{C}$ , unless otherwise specified

Minimum and maximum values are testing requirements. Typical values are characteristics of the device and are the result of engineering evaluation. Typical values are for information only and are not part of the testing requirements.

### Input

Parameter	Test condition	Symbol	Min	Typ.	Max	Unit
Forward voltage	$I_F = 5\text{ mA}$	$V_F$		1.15	1.4	V
Reverse current	$V_R = 6.0\text{ V}$	$I_R$		0.01	10	$\mu\text{A}$
Capacitance	$V_R = 0.0\text{ V}$ , $f = 1.0\text{ MHz}$	$C_O$		14		pF
Thermal resistance		$R_{thja}$		750		K/W

### Output

Parameter	Test condition	Symbol	Min	Typ.	Max	Unit
Collector-emitter leakage current	$V_{CE} = 20\text{ V}$	$I_{CEO}$			100	nA
Collector-emitter capacitance	$V_{CE} = 5.0\text{ V}$ , $f = 1.0\text{ MHz}$	$C_{CE}$		2.8		pF
Thermal resistance		$R_{thja}$		500		K/W

### Coupler

Parameter	Test condition	Symbol	Min	Typ.	Max	Unit
Collector-emitter saturation voltage	$I_F = 10\text{ mA}$ , $I_C = 2.0\text{ mA}$	$V_{CEsat}$		0.1	0.3	V
Coupling capacitance	$f = 1.0\text{ MHz}$	$C_C$		0.3		pF

### Current Transfer Ratio

Parameter	Test condition	Part	Symbol	Min	Typ.	Max	Unit
$I_C/I_F$	$I_F = 5.0\text{ mA}$ , $V_{CE} = 5.0\text{ V}$	SFH690AT	CTR	50		150	%
		SFH690BT	CTR	100		300	%
		SFH690CT	CTR	100		200	%
		SFH690ABT	CTR	50		300	%

### Switching Characteristics

Parameter	Test condition	Symbol	Min	Typ.	Max	Unit
Rise time	$I_C = 2.0 \text{ mA}$ , $V_{CC} = 5.0 \text{ V}$ , $R_L = 100 \Omega$	$t_r$		3.0		$\mu\text{s}$
Fall time	$I_C = 2.0 \text{ mA}$ , $V_{CC} = 5.0 \text{ V}$ , $R_L = 100 \Omega$	$t_f$		4.0		$\mu\text{s}$
Turn-on time	$I_C = 2.0 \text{ mA}$ , $V_{CC} = 5.0 \text{ V}$ , $R_L = 100 \Omega$	$t_{on}$		5.0		$\mu\text{s}$
Turn-off time	$I_C = 2.0 \text{ mA}$ , $V_{CC} = 5.0 \text{ V}$ , $R_L = 100 \Omega$	$t_{off}$		3.0		$\mu\text{s}$

### Typical Characteristics (Tamb = 25 °C unless otherwise specified)

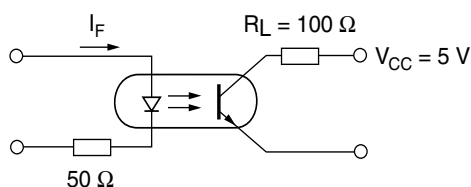

isfh690at\_01

Figure 2. Switching Operation (without Saturation)

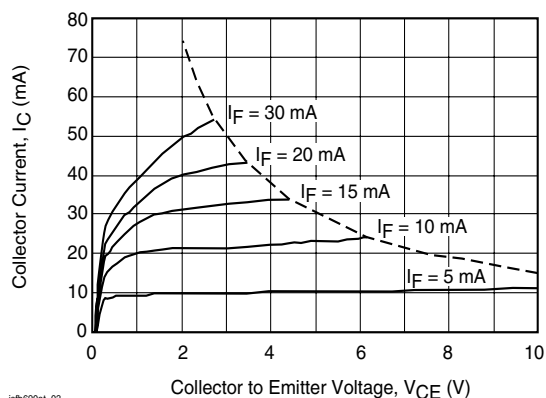

isfh690at\_03

Figure 4. Collector Current vs. Collector Emitter Voltage

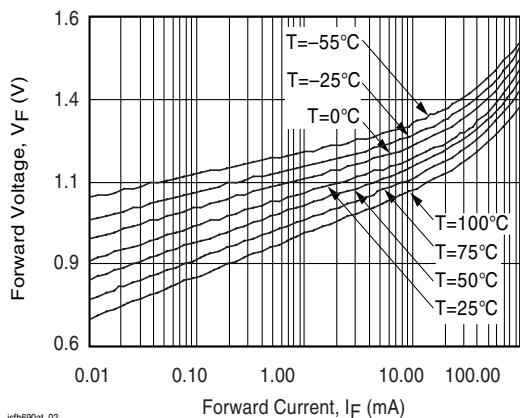

isfh690at\_02

Figure 3. Diode Forward Voltage vs. Forward Current

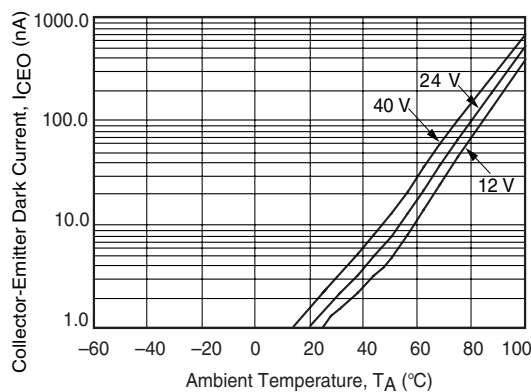

isfh690at\_04

Figure 5. Collector to Emitter Dark Current vs. Ambient Temperature

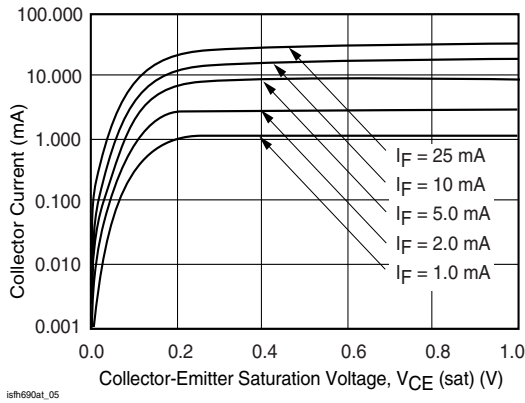

Figure 6. Collector Current vs. Collector-Emitter Saturation Voltage

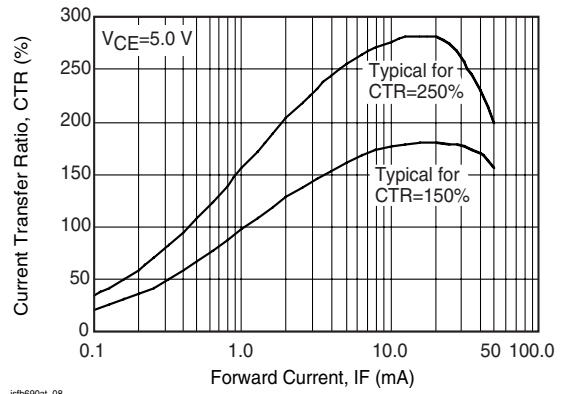

Figure 9. Current Transfer Ratio vs. Forward Current

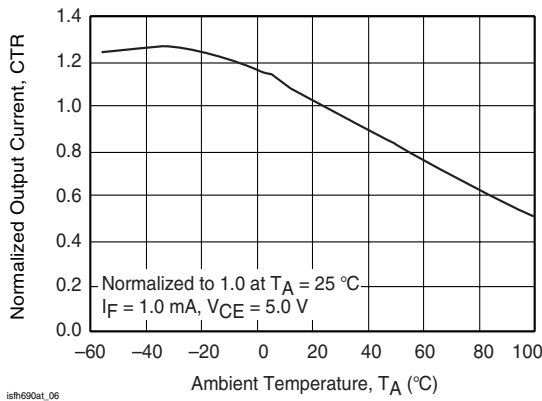

Figure 7. Normalized Output Current vs. Ambient Temperature

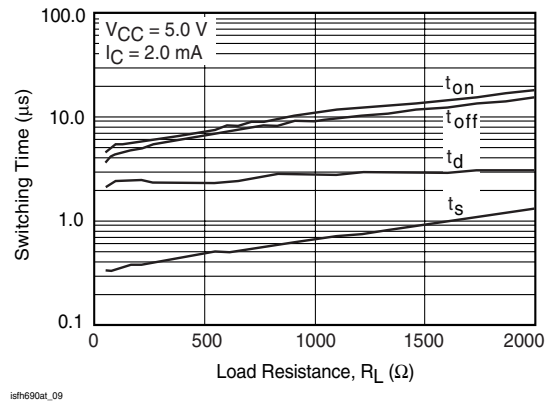

Figure 10. Switching Time vs. Load Resistance

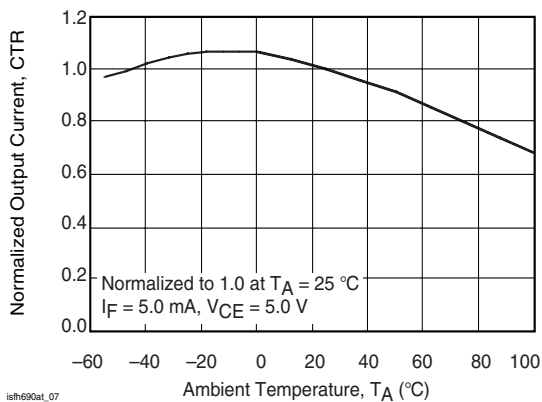

Figure 8. Normalized Output Current vs. Ambient Temperature

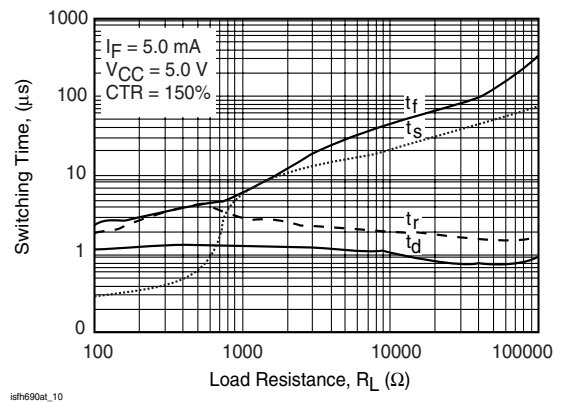

Figure 11. Switching Time vs. Load Resistance

# SFH690ABT/ AT/ BT/ CT



Vishay Semiconductors

## Package Dimensions in Inches (mm)

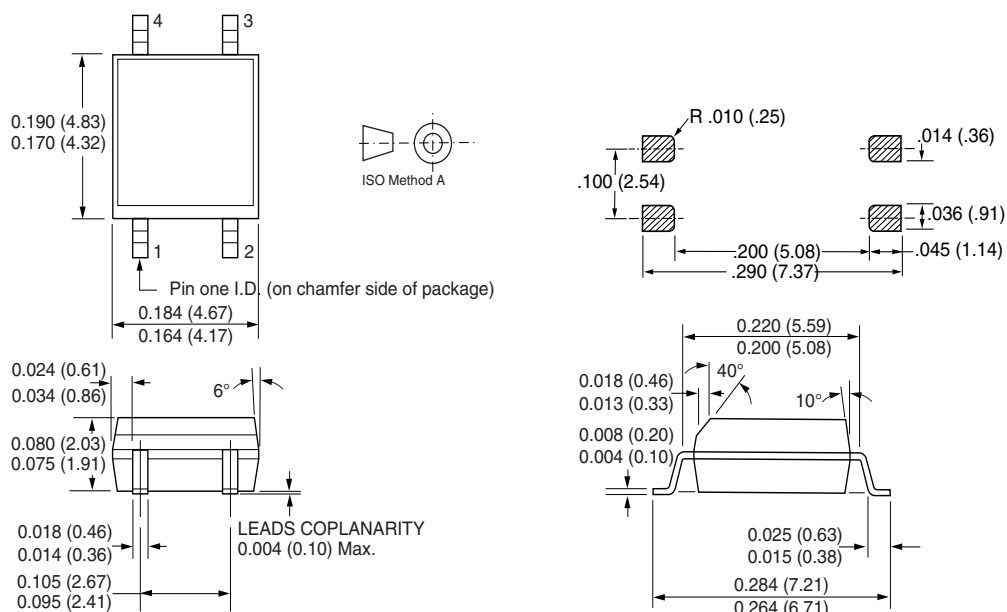

i178037



## Ozone Depleting Substances Policy Statement

It is the policy of Vishay Semiconductor GmbH to

1. Meet all present and future national and international statutory requirements.
2. Regularly and continuously improve the performance of our products, processes, distribution and operating systems with respect to their impact on the health and safety of our employees and the public, as well as their impact on the environment.

It is particular concern to control or eliminate releases of those substances into the atmosphere which are known as ozone depleting substances (ODSs).

The Montreal Protocol (1987) and its London Amendments (1990) intend to severely restrict the use of ODSs and forbid their use within the next ten years. Various national and international initiatives are pressing for an earlier ban on these substances.

Vishay Semiconductor GmbH has been able to use its policy of continuous improvements to eliminate the use of ODSs listed in the following documents.

1. Annex A, B and list of transitional substances of the Montreal Protocol and the London Amendments respectively
2. Class I and II ozone depleting substances in the Clean Air Act Amendments of 1990 by the Environmental Protection Agency (EPA) in the USA
3. Council Decision 88/540/EEC and 91/690/EEC Annex A, B and C (transitional substances) respectively.

Vishay Semiconductor GmbH can certify that our semiconductors are not manufactured with ozone depleting substances and do not contain such substances.

We reserve the right to make changes to improve technical design and may do so without further notice.

Parameters can vary in different applications. All operating parameters must be validated for each customer application by the customer. Should the buyer use Vishay Semiconductors products for any unintended or unauthorized application, the buyer shall indemnify Vishay Semiconductors against all claims, costs, damages, and expenses, arising out of, directly or indirectly, any claim of personal damage, injury or death associated with such unintended or unauthorized use.

Vishay Semiconductor GmbH, P.O.B. 3535, D-74025 Heilbronn, Germany  
Telephone: 49 (0)7131 67 2831, Fax number: 49 (0)7131 67 2423