

FEATURES

Conventional LED design : Simple to use

High Flux and Low Cost : More competitive advantages in the LED industry

Special body frame : Excellent transiting heat from LED chip operating under 150mA.

ADVANTAGES

Operating Current : 150mA .

Custom Design Light Sourcing Module for 0.6W····.

Excellent Heat Dissipation.

TYPICAL APPLICATIONS

Reading Light / Flashlight / Track Lighting

Under Shelf / Task Lighting

Emergency Lighting / Traffic Signals

Bollards / Security / Garden Lighting

Full Color Sign Boards

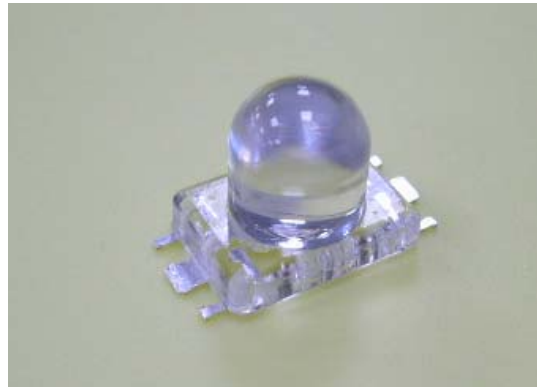

ABSOLUTE MAXIMUM RATINGS Tj=25°C

Parameter	EP2012-150G1	Units
DC Forward Current	150	mA
Pulsed Forward Current	500	mA
Power Dissipation	520	mW
Dark Current (VR=5V)	100	uA
Operating Temperature Range	-20 to 80	°C
Storage Temperature Range	-35 to 85	°C
Soldering Temperature	245	°C
Thermal Resistance Rθ(°C/W)	85	°C/W
LED Junction Temperature	110	°C

Operating conditions:

1.Amber operating condition under f=0.5 ~ 2 Hz and 1/2 duty factor .

2. 520mw(White) : 6 pins of E-Power LED required soldering on PCB.

(PCB : 24.5 mm *24.5 mm , 1.6 t / two layers / 2.0 oz .)

3.Convective IR Reflow SolderingConvective IR Reflow Soldering.

ELECTRICAL CHARACTERISTICS

Tj=25°C IF=150mA

Device Type	Forward Voltage VF (Volts)			Dark Current VR=5V IR=(uA)		Intensity Iv (cd)		Total Flux Φv (lm)	Wavelength λD (nm)	Viewing Angle 2θ1/2 (Degrees)
	Min.	Typ.	Max.	Typ.	Max.	Min.	Typ.	Typ.	Typ.	Typ.
EP2012-150G1	3.0	3.4	4.0	10	100	18	30	3	525	10°

This specification is subject to change without notice.

OUTLINE DRAWINGS

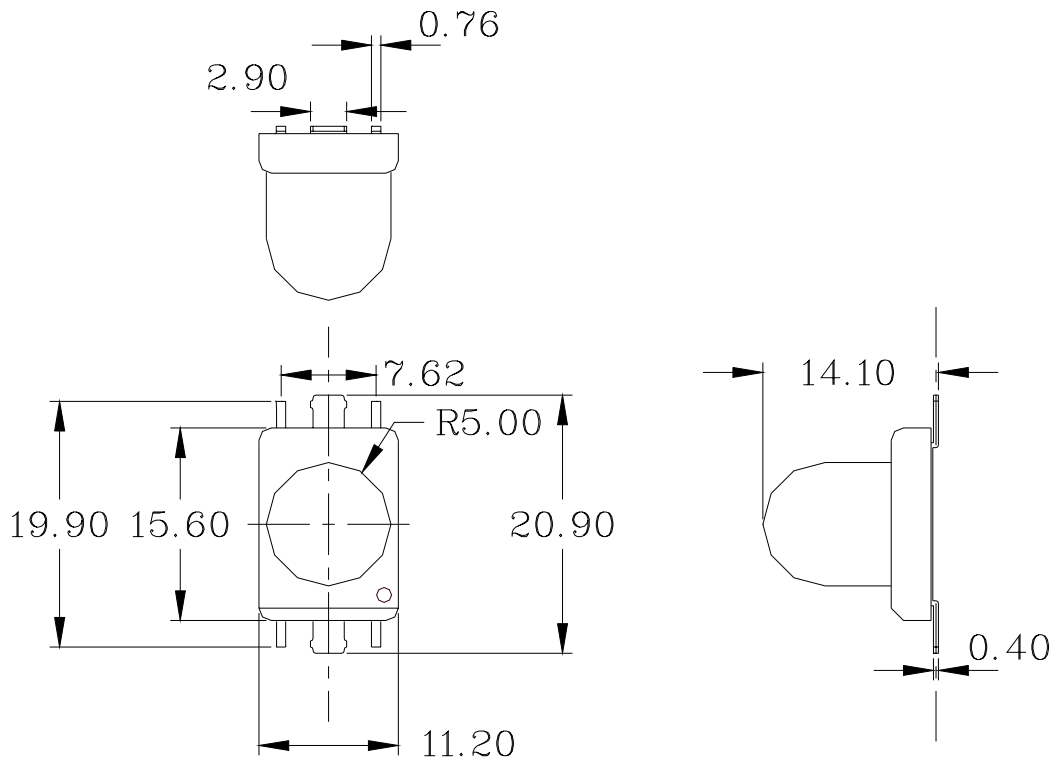

NOTE

1. All dimensions are in millimeters.
2. Tolerance is 0.25mm unless otherwise specified.
3. This specification is subject to change without notice.

CHARACTERISTICS CURVE

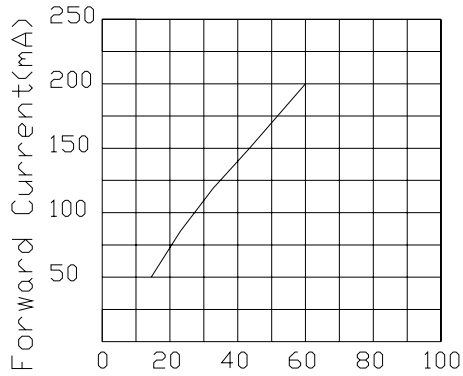

Junction Temperature (°C)
GREEN

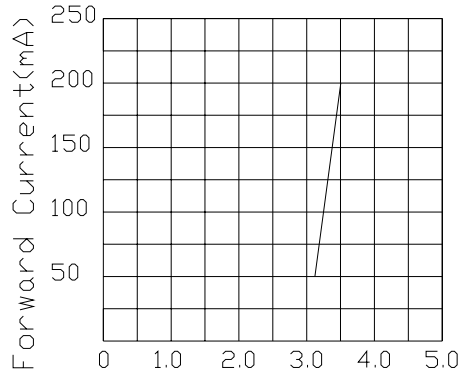

Forward Voltage VF (V)
GREEN

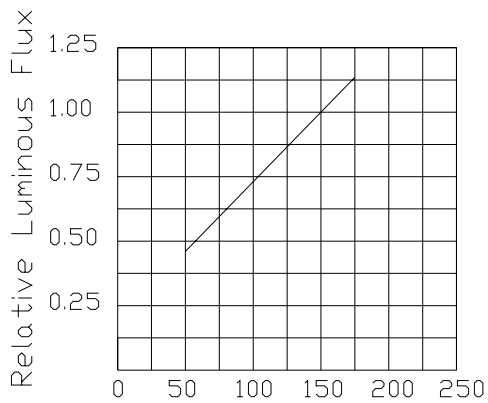

Forward Current (mA)
GREEN

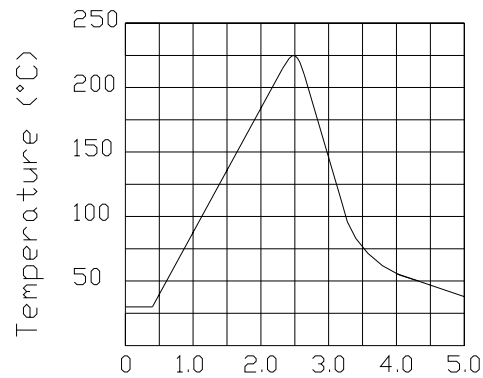

TIME (min)
Soldering Temperature

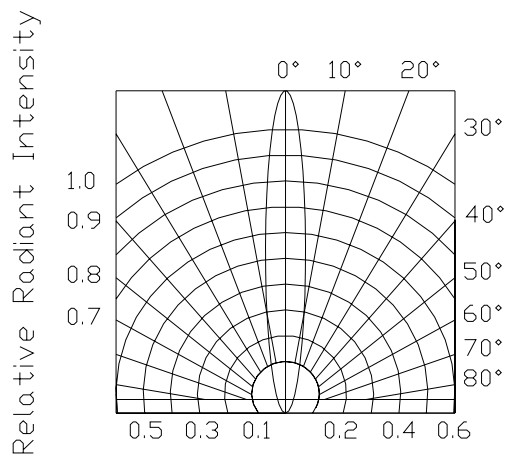

VIEW ANGLE
EP2012-150XX

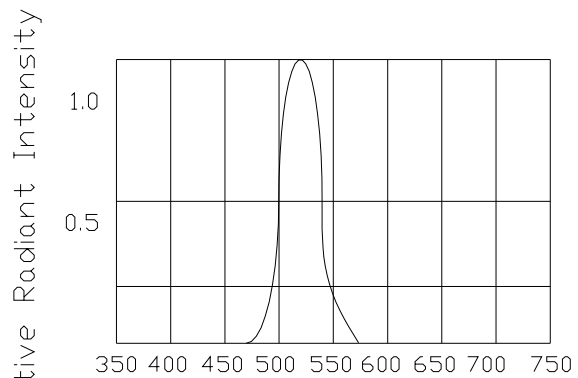

Wavelength (nm)
Spectral Distribution
GREEN

Operation Life

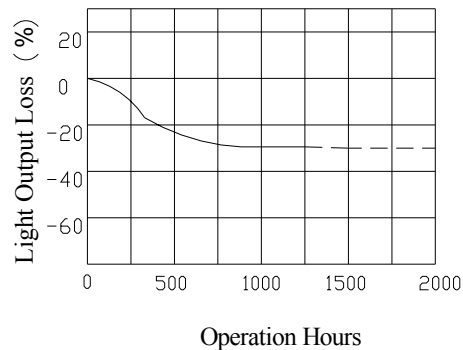

BLUE , CYAN , GREEN , WHITE

PIN CONNECTION

COLOR	R	G	B	C	A
ANODE	6	6	6	6	6
CATHODE	2 5	3	3	3	2 5

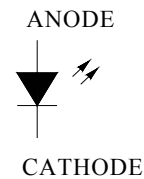
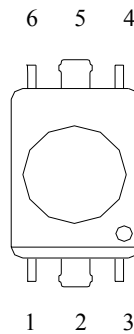

TEST CIRCUIT

COLOR	Vf (min)	R(100mA)	R(150mA)
G	3.5V	15 Ω	10 Ω

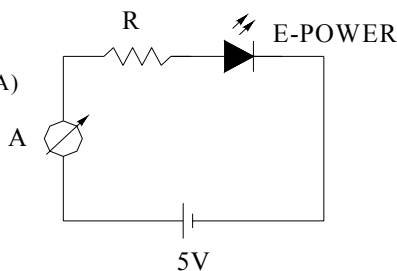

PART NO. SYSTEM OF E-Power LED

EP 2 01 2-150 G1

1---2-3-4-5-----6-----7

1.E -Power LED

2.YEAR 2002

3.PACKAGE TYPE:01=10mm LENS;03=5mm LENS;04=11 mm LENS

4.VIEWING ANGLE:2*5=10°

5.CURRENT:150mA

6. λD: G1=525nm (GREEN)