

# IRG4PC50UD

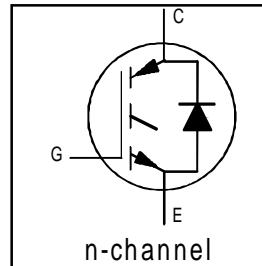
INSULATED GATE BIPOLAR TRANSISTOR WITH ULTRAFAST SOFT RECOVERY DIODE UltraFast CoPack IGBT

## Features

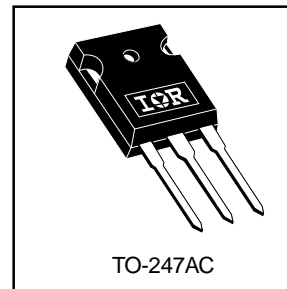
- UltraFast: Optimized for high operating frequencies 8-40 kHz in hard switching, >200 kHz in resonant mode
- Generation 4 IGBT design provides tighter parameter distribution and higher efficiency than Generation 3
- IGBT co-packaged with HEXFRED™ ultrafast, ultra-soft-recovery anti-parallel diodes for use in bridge configurations
- Industry standard TO-247AC package

## Benefits

- Generation 4 IGBT's offer highest efficiencies available
- IGBT's optimized for specific application conditions
- HEXFRED diodes optimized for performance with IGBT's. Minimized recovery characteristics require less/no snubbing
- Designed to be a "drop-in" replacement for equivalent industry-standard Generation 3 IR IGBT's



$V_{CES} = 600V$   
 $V_{CE(on)} \text{ typ.} = 1.65V$   
 @  $V_{GE} = 15V, I_C = 27A$



## Absolute Maximum Ratings

	Parameter	Max.	Units
$V_{CES}$	Collector-to-Emitter Voltage	600	V
$I_C @ T_C = 25^\circ C$	Continuous Collector Current	55	A
$I_C @ T_C = 100^\circ C$	Continuous Collector Current	27	
$I_{CM}$	Pulsed Collector Current ①	220	
$I_{LM}$	Clamped Inductive Load Current ②	220	
$I_F @ T_C = 100^\circ C$	Diode Continuous Forward Current	25	
$I_{FM}$	Diode Maximum Forward Current	220	
$V_{GE}$	Gate-to-Emitter Voltage	$\pm 20$	V
$P_D @ T_C = 25^\circ C$	Maximum Power Dissipation	200	W
$P_D @ T_C = 100^\circ C$	Maximum Power Dissipation	78	
$T_J$	Operating Junction and Storage Temperature Range	-55 to +150	$^\circ C$
$T_{STG}$			
	Soldering Temperature, for 10 sec.	300 (0.063 in. (1.6mm) from case)	
	Mounting Torque, 6-32 or M3 Screw.	10 lbf•in (1.1 N•m)	

## Thermal Resistance

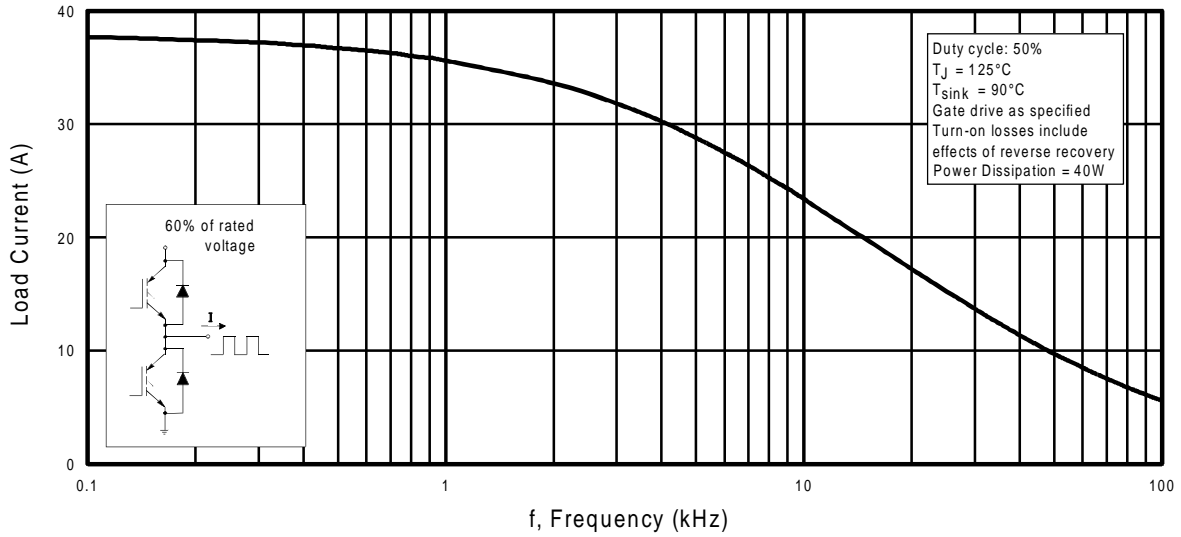
	Parameter	Min.	Typ.	Max.	Units
$R_{\theta JC}$	Junction-to-Case - IGBT	-----	-----	0.64	$^\circ C/W$
$R_{\theta JC}$	Junction-to-Case - Diode	-----	-----	0.83	
$R_{\theta CS}$	Case-to-Sink, flat, greased surface	-----	0.24	-----	
$R_{\theta JA}$	Junction-to-Ambient, typical socket mount	-----	-----	40	
$W_t$	Weight	-----	6 (0.21)	-----	g (oz)

## Electrical Characteristics @ T<sub>J</sub> = 25°C (unless otherwise specified)

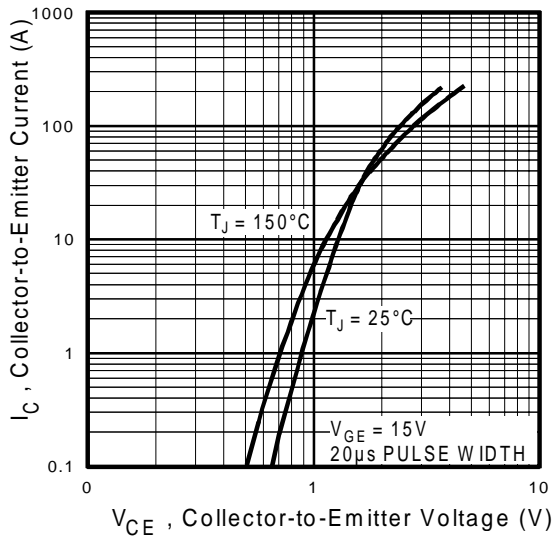
	Parameter	Min.	Typ.	Max.	Units	Conditions
V <sub>(BR)CES</sub>	Collector-to-Emitter Breakdown Voltage <sup>③</sup>	600	----	----	V	V <sub>GE</sub> = 0V, I <sub>C</sub> = 250μA
ΔV <sub>(BR)CES</sub> /ΔT <sub>J</sub>	Temperature Coeff. of Breakdown Voltage	----	0.60	----	V/°C	V <sub>GE</sub> = 0V, I <sub>C</sub> = 1.0mA
V <sub>CE(on)</sub>	Collector-to-Emitter Saturation Voltage	----	1.65	2.0	V	I <sub>C</sub> = 27A V <sub>GE</sub> = 15V
		----	2.0	----		I <sub>C</sub> = 55A See Fig. 2, 5
		----	1.6	----		I <sub>C</sub> = 27A, T <sub>J</sub> = 150°C
V <sub>GE(th)</sub>	Gate Threshold Voltage	3.0	----	6.0		V <sub>CE</sub> = V <sub>GE</sub> , I <sub>C</sub> = 250μA
ΔV <sub>GE(th)</sub> /ΔT <sub>J</sub>	Temperature Coeff. of Threshold Voltage	----	-13	----	mV/°C	V <sub>CE</sub> = V <sub>GE</sub> , I <sub>C</sub> = 250μA
g <sub>fe</sub>	Forward Transconductance <sup>④</sup>	16	24	----	S	V <sub>CE</sub> = 100V, I <sub>C</sub> = 27A
I <sub>CES</sub>	Zero Gate Voltage Collector Current	----	----	250	μA	V <sub>GE</sub> = 0V, V <sub>CE</sub> = 600V
		----	----	6500		V <sub>GE</sub> = 0V, V <sub>CE</sub> = 600V, T <sub>J</sub> = 150°C
V <sub>FM</sub>	Diode Forward Voltage Drop	----	1.3	1.7	V	I <sub>C</sub> = 25A See Fig. 13
		----	1.2	1.5		I <sub>C</sub> = 25A, T <sub>J</sub> = 150°C
I <sub>GES</sub>	Gate-to-Emitter Leakage Current	----	----	±100	nA	V <sub>GE</sub> = ±20V

## Switching Characteristics @ T<sub>J</sub> = 25°C (unless otherwise specified)

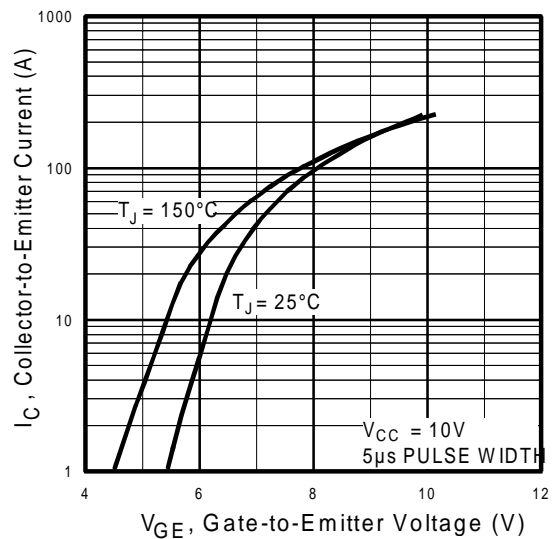
	Parameter	Min.	Typ.	Max.	Units	Conditions
Q <sub>g</sub>	Total Gate Charge (turn-on)	----	180	270	nC	I <sub>C</sub> = 27A
Q <sub>ge</sub>	Gate - Emitter Charge (turn-on)	----	25	38		V <sub>CC</sub> = 400V See Fig. 8
Q <sub>gc</sub>	Gate - Collector Charge (turn-on)	----	61	90		V <sub>GE</sub> = 15V
t <sub>d(on)</sub>	Turn-On Delay Time	----	46	----	ns	T <sub>J</sub> = 25°C
t <sub>r</sub>	Rise Time	----	25	----		I <sub>C</sub> = 27A, V <sub>CC</sub> = 480V
t <sub>d(off)</sub>	Turn-Off Delay Time	----	140	230		V <sub>GE</sub> = 15V, R <sub>G</sub> = 5.0Ω
t <sub>f</sub>	Fall Time	----	74	110		Energy losses include "tail" and diode reverse recovery.
E <sub>on</sub>	Turn-On Switching Loss	----	0.99	----	mJ	See Fig. 9, 10, 11, 18
E <sub>off</sub>	Turn-Off Switching Loss	----	0.59	----		
E <sub>ts</sub>	Total Switching Loss	----	1.58	1.9		
t <sub>d(on)</sub>	Turn-On Delay Time	----	44	----	ns	T <sub>J</sub> = 150°C, See Fig. 9, 10, 11, 18
t <sub>r</sub>	Rise Time	----	27	----		I <sub>C</sub> = 27A, V <sub>CC</sub> = 480V
t <sub>d(off)</sub>	Turn-Off Delay Time	----	240	----		V <sub>GE</sub> = 15V, R <sub>G</sub> = 5.0Ω
t <sub>f</sub>	Fall Time	----	130	----		Energy losses include "tail" and diode reverse recovery.
E <sub>ts</sub>	Total Switching Loss	----	2.3	----	mJ	
L <sub>E</sub>	Internal Emitter Inductance	----	13	----	nH	Measured 5mm from package
C <sub>ies</sub>	Input Capacitance	----	4000	----	pF	V <sub>GE</sub> = 0V
C <sub>oes</sub>	Output Capacitance	----	250	----		V <sub>CC</sub> = 30V See Fig. 7
C <sub>res</sub>	Reverse Transfer Capacitance	----	52	----		f = 1.0MHz
t <sub>rr</sub>	Diode Reverse Recovery Time	----	50	75	ns	T <sub>J</sub> = 25°C See Fig. 14
		----	105	160		T <sub>J</sub> = 125°C
I <sub>rr</sub>	Diode Peak Reverse Recovery Current	----	4.5	10	A	T <sub>J</sub> = 25°C See Fig. 15
		----	8.0	15		T <sub>J</sub> = 125°C
Q <sub>rr</sub>	Diode Reverse Recovery Charge	----	112	375	nC	T <sub>J</sub> = 25°C See Fig. 16
		----	420	1200		T <sub>J</sub> = 125°C
di <sub>(rec)M</sub> /dt	Diode Peak Rate of Fall of Recovery During t <sub>b</sub>	----	250	----	A/μs	T <sub>J</sub> = 25°C
		----	160	----		T <sub>J</sub> = 125°C



**Fig. 1 - Typical Load Current vs. Frequency**  
 (Load Current =  $I_{\text{RMS}}$  of fundamental)

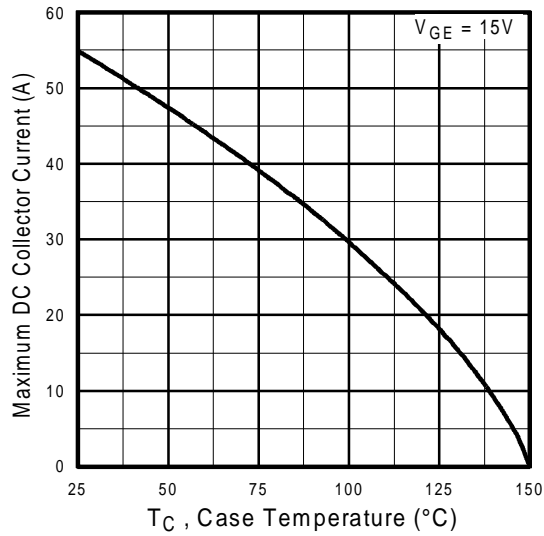


**Fig. 2 - Typical Output Characteristics**

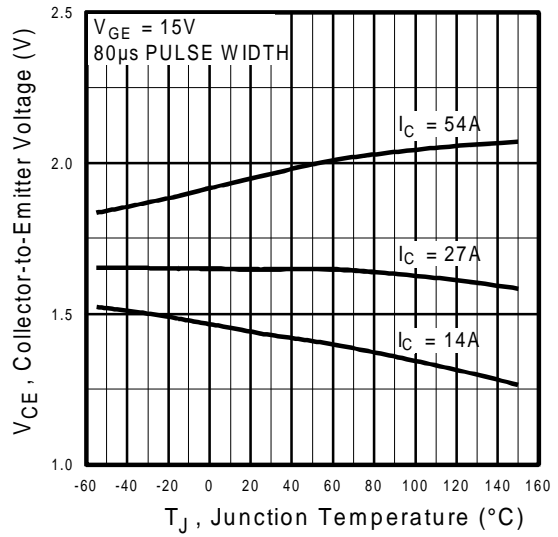


**Fig. 3 - Typical Transfer Characteristics**

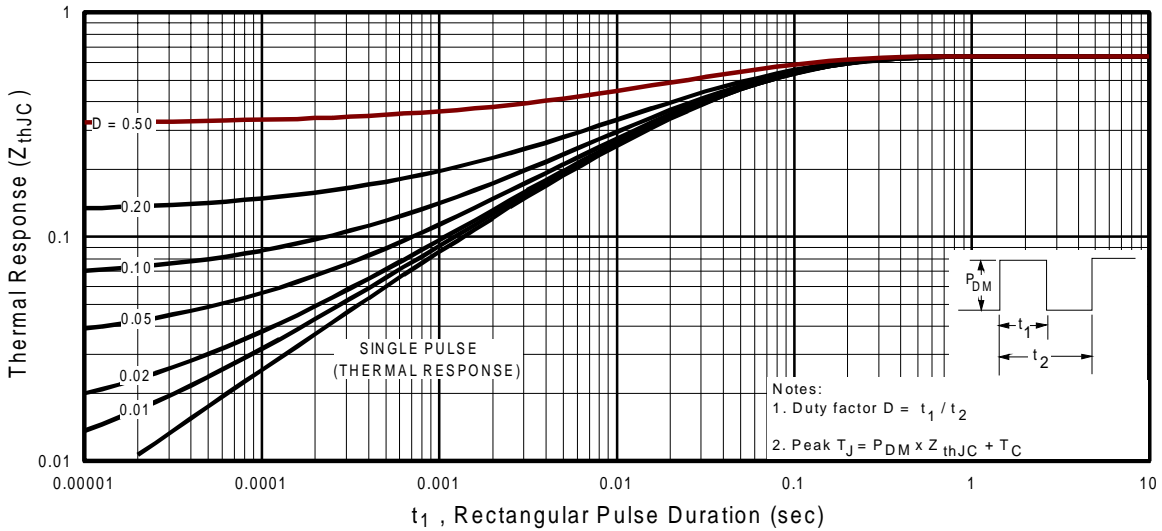
# IRG4PC50UD



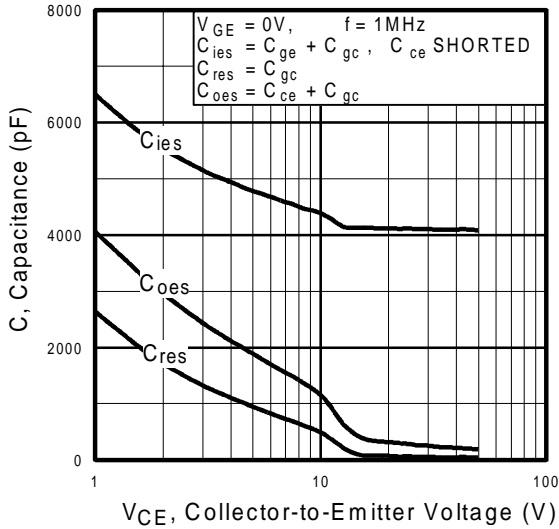
**Fig. 4** - Maximum Collector Current vs. Case Temperature



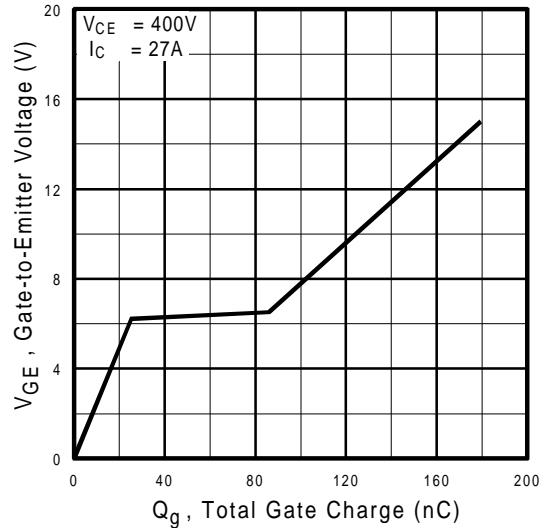
**Fig. 5** - Typical Collector-to-Emitter Voltage vs. Junction Temperature



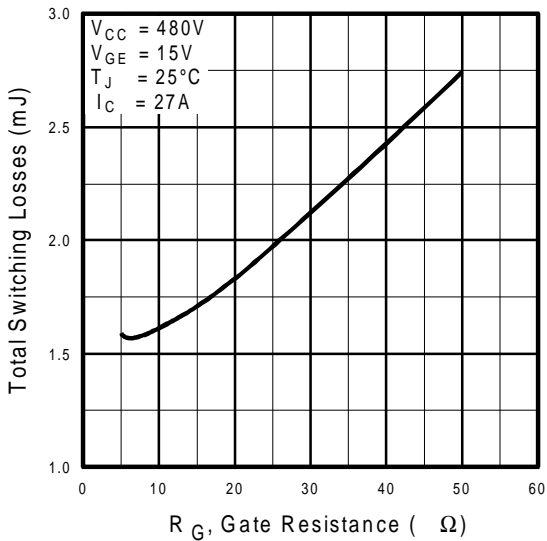
**Fig. 6** - Maximum IGBT Effective Transient Thermal Impedance, Junction-to-Case



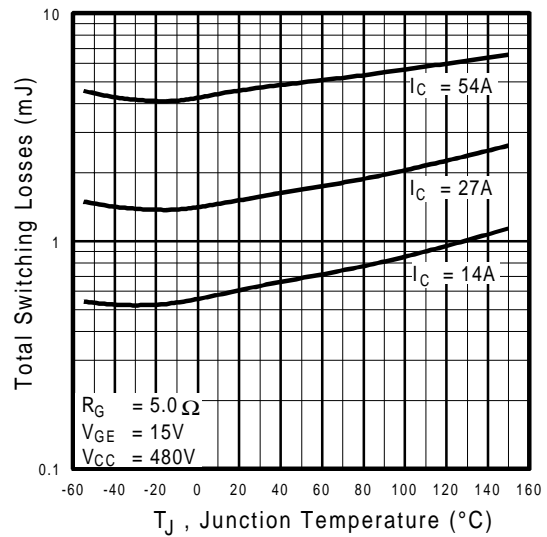
**Fig. 7** - Typical Capacitance vs. Collector-to-Emitter Voltage



**Fig. 8** - Typical Gate Charge vs. Gate-to-Emitter Voltage

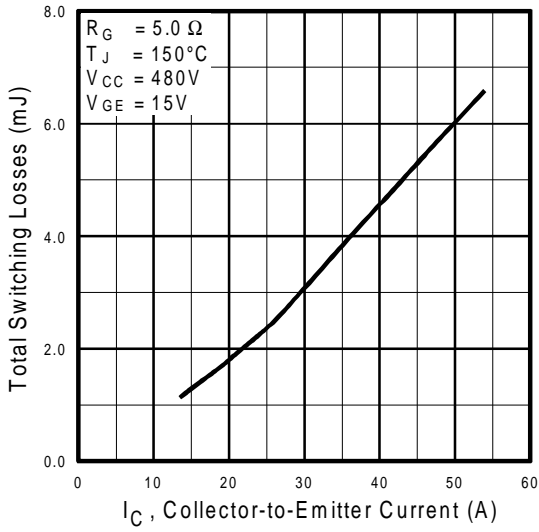


**Fig. 9** - Typical Switching Losses vs. Gate Resistance

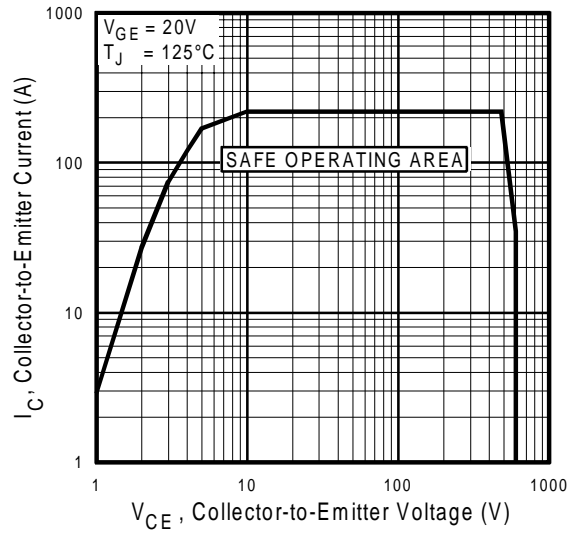


**Fig. 10** - Typical Switching Losses vs. Junction Temperature

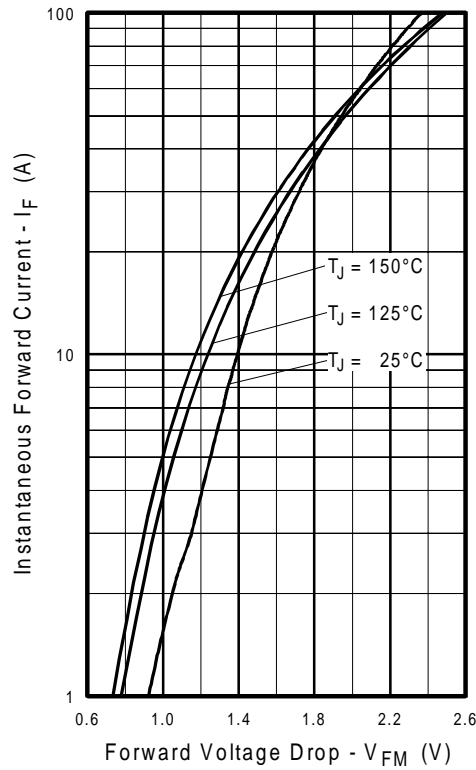
# IRG4PC50UD



**Fig. 11** - Typical Switching Losses vs. Collector-to-Emitter Current



**Fig. 12** - Turn-Off SOA



**Fig. 13** - Maximum Forward Voltage Drop vs. Instantaneous Forward Current

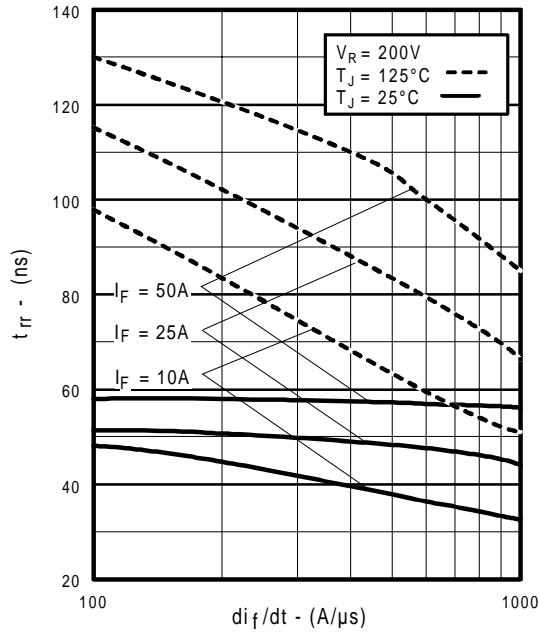


Fig. 14 - Typical Reverse Recovery vs.  $di_f/dt$

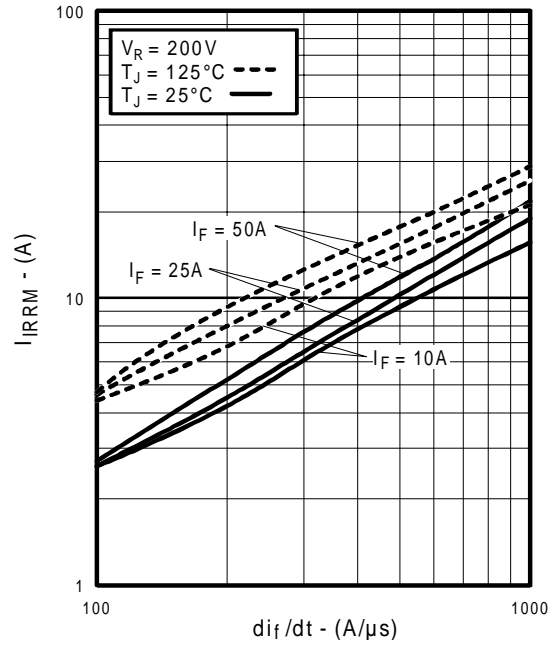


Fig. 15 - Typical Recovery Current vs.  $di_f/dt$

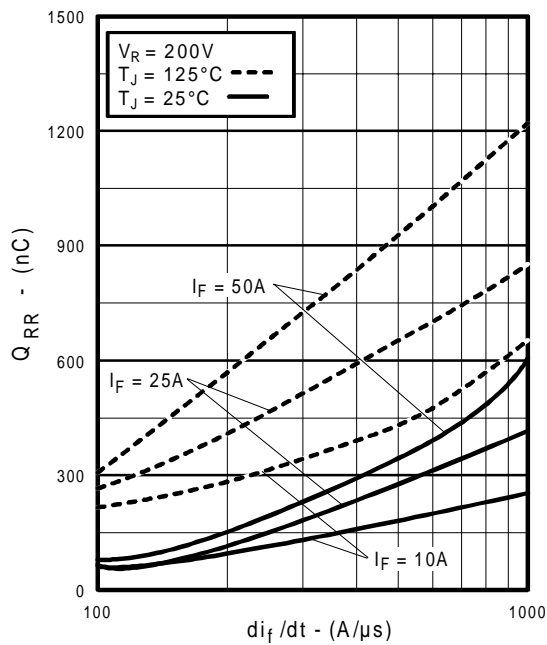


Fig. 16 - Typical Stored Charge vs.  $di_f/dt$

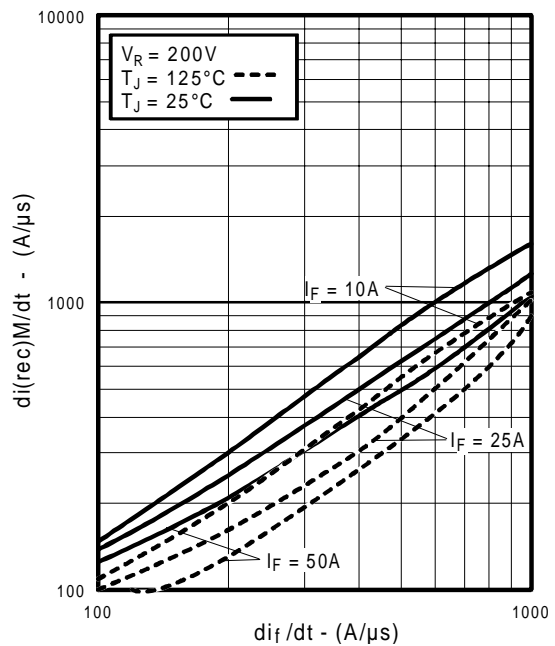
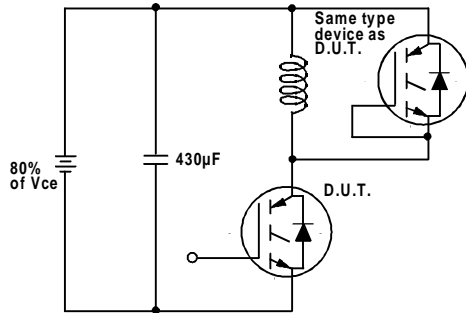
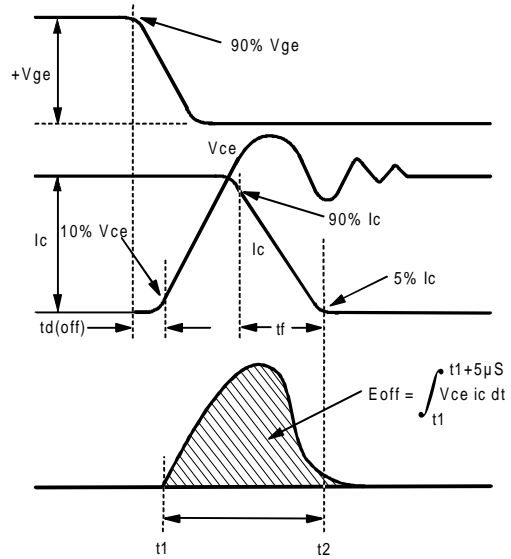


Fig. 17 - Typical  $di_{(rec)M}/dt$  vs.  $di_f/dt$

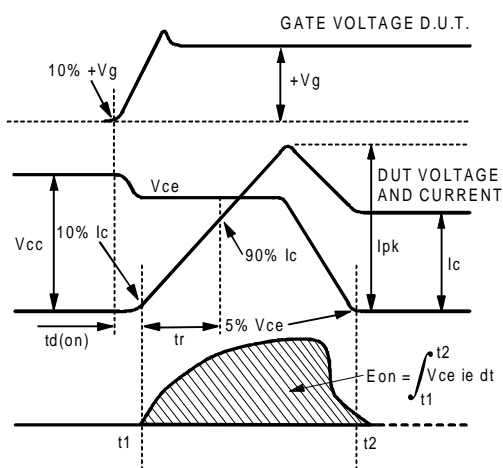
# IRG4PC50UD



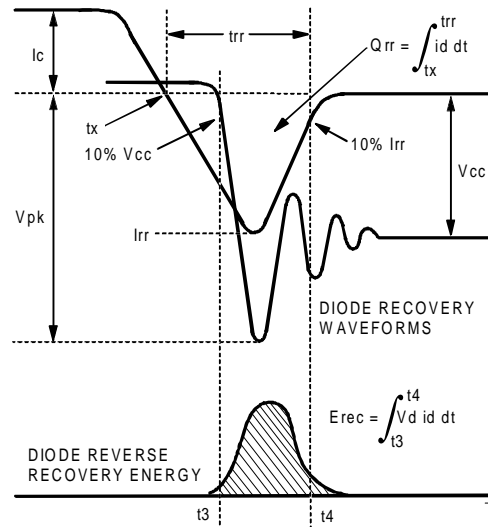
**Fig. 18a** - Test Circuit for Measurement of  $I_{LM}$ ,  $E_{on}$ ,  $E_{off}(\text{diode})$ ,  $t_{rr}$ ,  $Q_{rr}$ ,  $I_{rr}$ ,  $t_{d(on)}$ ,  $t_r$ ,  $t_{d(off)}$ ,  $t_f$



**Fig. 18b** - Test Waveforms for Circuit of Fig. 18a, Defining  $E_{off}$ ,  $t_{d(off)}$ ,  $t_f$



**Fig. 18c** - Test Waveforms for Circuit of Fig. 18a, Defining  $E_{on}$ ,  $t_{d(on)}$ ,  $t_r$



**Fig. 18d** - Test Waveforms for Circuit of Fig. 18a, Defining  $E_{rec}$ ,  $t_{rr}$ ,  $Q_{rr}$ ,  $I_{rr}$



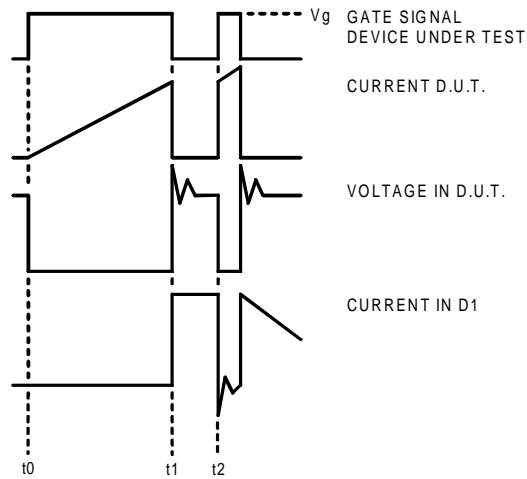


Figure 18e. Macro Waveforms for Figure 18a's Test Circuit

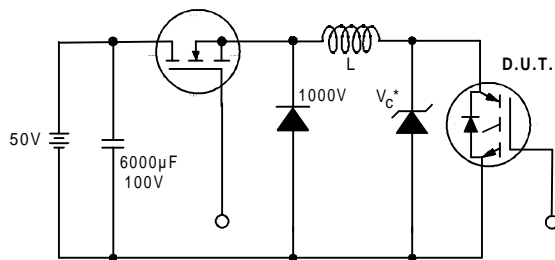


Figure 19. Clamped Inductive Load Test Circuit

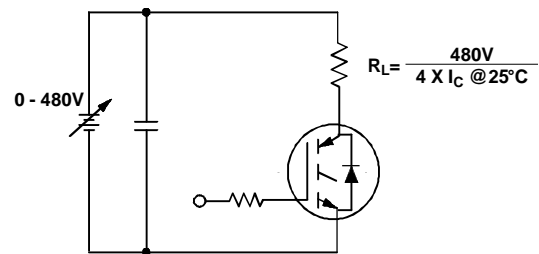


Figure 20. Pulsed Collector Current Test Circuit

# IRG4PC50UD

## Notes:

- ① Repetitive rating:  $V_{GE} = 20V$ ; pulse width limited by maximum junction temperature (figure 20)
- ②  $V_{CC} = 80\%(V_{CES})$ ,  $V_{GE} = 20V$ ,  $L = 10\mu H$ ,  $R_G = 5.0\Omega$  (figure 19)
- ③ Pulse width  $\leq 80\mu s$ ; duty factor  $\leq 0.1\%$ .
- ④ Pulse width  $5.0\mu s$ , single shot.

## Case Outline — TO-247AC

