

Features

1. Ac inputs.
2. Opaque type, mini-flat package.
3. Subminiature type (The volume is smaller than that of our conventional DIP type by as far as 30%)
4. Isolation voltage between input and output (Viso:3750Vrms).

Applications

1. Hybrid substrates that require high density mounting.
2. Programmable controllers.

Classification table of current transfer ratio is shown below.

| RANK MARK | CTR(%) |
|-----------|-----------|
| A | 50 TO 150 |
| B | 20 TO 400 |

Outside Dimension : Unit (mm)

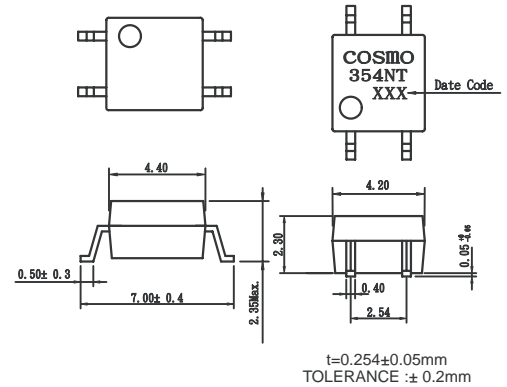

Schematic : Top View

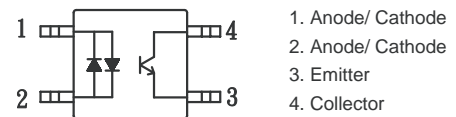

Absolute Maximum Ratings

(Ta=25°C)

| Parameter | | Symbol | Rating | Unit |
|---------------------------------|-----------------------------|--------|-------------|------|
| Input | Forward current | IF | ± 50 | mA |
| | Peak forward current | IFM | ± 1 | A |
| | Power dissipation | P | 70 | mW |
| Output | Collector-emitter voltage | VCEO | 60 | V |
| | Emitter-collector voltage | VECO | 5 | V |
| | Collector current | IC | 50 | mA |
| | Collector power dissipation | PC | 150 | mW |
| Total power dissipation | | Ptot | 170 | mW |
| Isolation voltage 1 minute | | Viso | 3750 | Vrms |
| Operating temperature | | Topr | -30 to +100 | °C |
| Storage temperature | | Tstg | -40 to +125 | °C |
| Soldering temperature 10 second | | Tsol | 260 | °C |

Electro-optical Characteristics

(Ta=25°C)

| Parameter | | Symbol | Conditions | MIN. | TYP. | MAX. | Unit |
|--------------------------|--------------------------------------|-----------|---------------------------------|--------------------|------------------|------|------|
| Input | Forward voltage | VF | IF = ± 20mA | — | 1.2 | 1.4 | V |
| | Terminal capacitance | Ct | V = 0, f = 1kHz | — | 30 | 250 | pF |
| Output | Collector dark current | ICEO | VCE = 20V, IF = 0 | — | — | 0.1 | uA |
| | Collector-emitter breakdown voltage | BVCEO | IC = 0.1mA, IF = 0 | 60 | — | — | V |
| | Emitter-collector breakdown voltage | BVECO | IE = 100uA, IF = 0 | 5 | — | — | V |
| Transfer characteristics | Current transfer ratio | CTR | IF = ± 1mA, VCE = 5V | 20 | — | 400 | % |
| | Collector-emitter saturation voltage | VCE (sat) | IF = ± 20mA, IC = 1mA | — | 0.1 | 0.3 | V |
| | Isolation resistance | Riso | DC500V, 40 to 60%RH | 5X10 ¹⁰ | 10 ¹¹ | — | ohm |
| | Floating capacitance | Cf | V = 0, f = 1MHz | — | 0.6 | 1.0 | pF |
| | Response time (Rise) | tr | VCE = 2V, IC = 2mA, RL = 100ohm | — | 4 | 18 | us |
| | Response time (Fall) | tf | | — | 3 | 18 | us |

Fig.1 Forward Current vs. Ambient Temperature

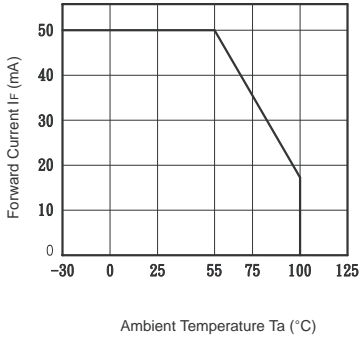

Fig.2 Diode Power Dissipation vs. Ambient Temperature

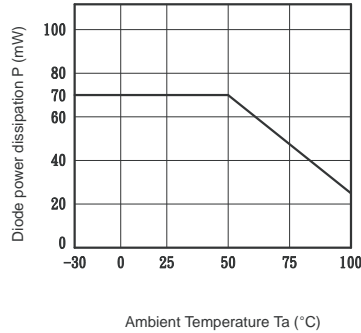

Fig.3 Collector Power Dissipation vs. Ambient Temperature

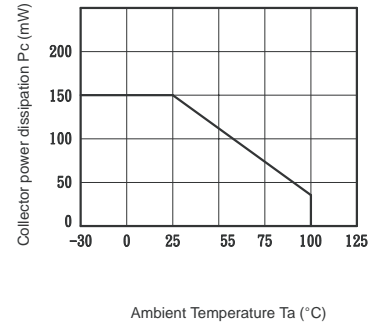

Fig.4 Total Power Dissipation vs. Ambient Temperature

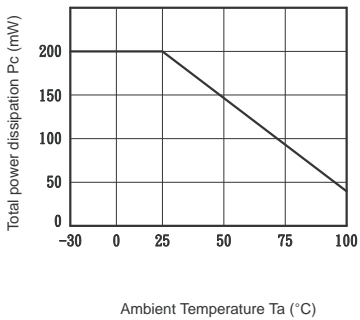

Fig.5 Peak Forward Current vs. Duty Ratio

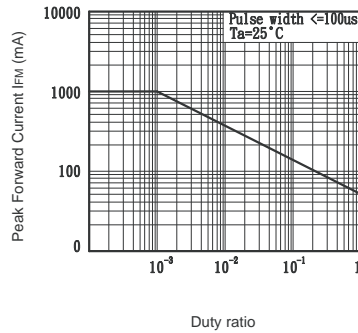

Fig.6 Forward Current vs. Forward Voltage

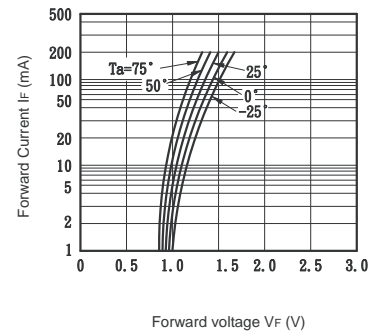

Fig.7 Current Transfer Ratio vs. Forward Current

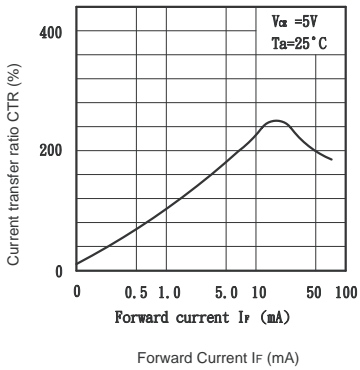

Fig.8 Collector Current vs. Collector-emitter Voltage

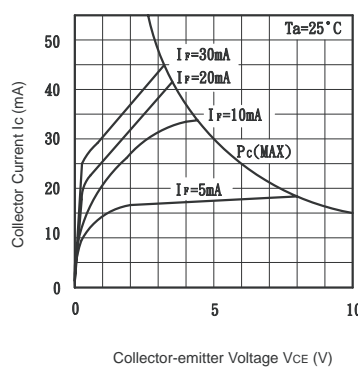

Fig.9 Relative Current Transfer Ratio vs. Ambient Temperature

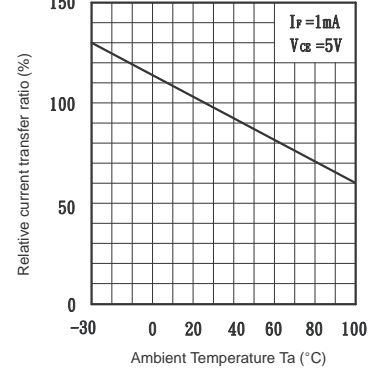

Fig.10 Collector-emitter Saturation Voltage vs. Ambient Temperature

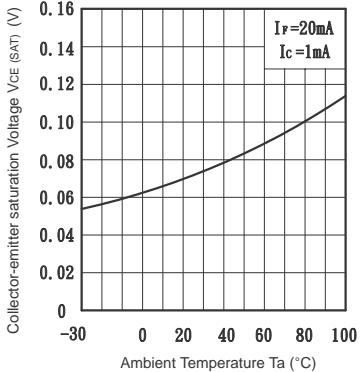

Fig.11 Collector Dark Current vs. Ambient Temperature

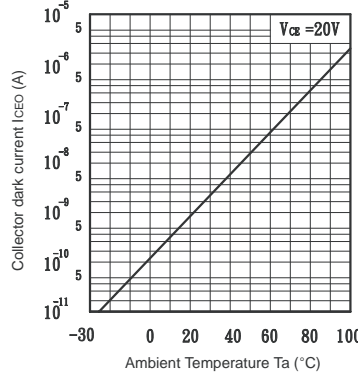

Fig.12 Response Time vs. Load Resistance

