

AN8377N

3-channel Linear Driver

■ Overview

The AN8377N is an IC which incorporates 3 circuits of BTL drivers for driving various DC motors such as actuators (focus, tracking, traverse), spindles, and loading of the CD players, and the +5V low drop type power supply.

■ Features

- Operating supply voltage range ; $V_{CC}=5.5V$ to $18V$
- Built-in 3 circuits of voltage BTL drivers
(maximum drive current : $500mA$)
- Stable circuit operation against supply voltage change and temperature change due to the built-in stabilized power supply
- Built-in +5V low drop power supply (external PNP power transistor)
- Built-in reset circuit (reset voltage : $4.82V$)
- Built-in thermal protective circuit (operating temperature : 159 ; typ.)
- Built-in power cut circuit (motor driver 1 only)

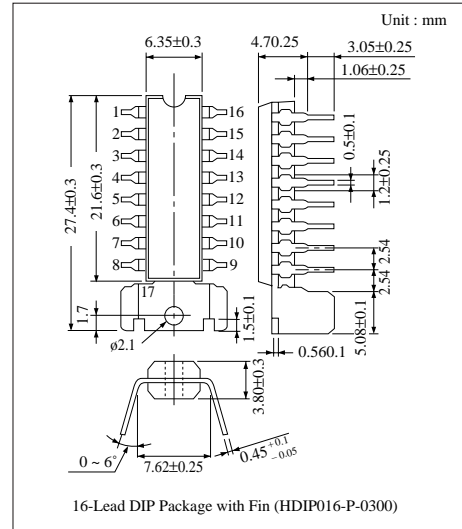

■ Applications

Linear driving of the DC motors and actuators of the CD players, CD radio cassette tape recorder, and so on.

■ Block Diagram

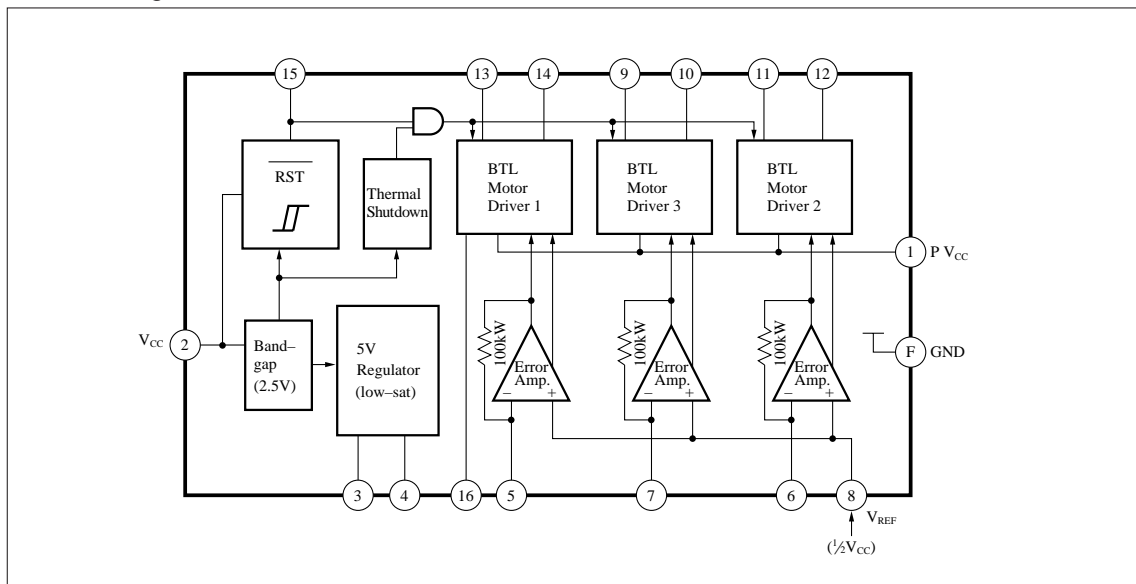

■ Absolute Maximum Ratings (Ta=25°C)

Parameter	Symbol	Rating	Unit
Supply Voltage	V _{CC}	20	V
Power Dissipation	P _D	1500	mW
Operating Ambient Temperature	T _{opr}	-25 ~ +80	°C
Storage Temperature	T _{stg}	-55 ~ +150	°C

■ Recommended Operating Range (Ta=25°C)

Parameter	Symbol	Range
Operating Supply Voltage Range	V _{CC}	5.5V ~ 16V

■ Electrical Characteristics (Ta=25°C)

Parameter	Symbol	Condition	min.	typ.	max.	Unit
No Load Current	I _{CC}	V _{CC} =12V	7	10.5	15	mA
5V Regulator Output Voltage	V _{RO}	V _{CC} =12V, R _L =50W	4.75	5	5.25	V
5V Regulator Load Change	DV _{RI}	V _{CC} =12V, R _L =50W ~ 25W	-15	—	30	mV
5V Regulator Input Change	DV _{RVC}	V _{CC} =15.5V ~ 5.5V, R _L =50W	-15	—	50	mV
Reset Threshold Voltage	V _{RST}		4.55	4.82	5.1	V
Reset Threshold Hysteresis Width	V _{HYS}		90	170	310	mV
Reset Operating Minimum Voltage	V _{R (min.)}	Minimum V _{CC} Voltage at which V15=Low	3.1	—	—	V
Input Offset Voltage	V _{IOF}	V _{CC} =18V, R _L =20W, R _{IN} =10kW	-7	—	7	mV
Output Offset Voltage	V _{OOF}	V _{CC} =18V, R _L =20W, R _{IN} =10kW	-50	—	50	mV
Gain (+)	G ₊	V _{CC} =18V, R _L =20W, R _{IN} =10kW	16.5	20	22.5	dB
(+) (-) Relative Gain	G _R	V _{CC} =18V, R _L =20W, R _{IN} =10kW	-0.85	—	0.85	dB
Limit Voltage (+)	V _{L+}	V _{CC} =18V, R _L =20W, R _{IN} =10kW	7.1	—	10.9	V
Limit Voltage (-)	V _{L-}	V _{CC} =18V, R _L =20W, R _{IN} =10kW	-10.9	—	-7.1	V
Dead Zone Width	V _{DZ}	V _{CC} =18V, R _L =20W, R _{IN} =10kW	-10	—	30	mV
PC Input Threshold (L)	V _{PCL}	V _{CC} =18V	—	—	1.2	V
PC Input Threshold (H)	V _{PCH}	V _{CC} =18V	2.8	—	—	V
Motor Driver 2 Output Voltage at Reset	V _{2RS}	V _{CC} =3.5V, R _L =10kW	-50	—	50	mV
Motor Driver 3 Output Voltage at Reset	V _{3RS}	V _{CC} =3.5V, R _L =10kW	-50	—	50	mV
Motor Driver 1 Output Voltage at Reset	V _{1RS}	V _{CC} =3.5V, R _L =10kW	-50	—	50	mV
5V Regulator External Transistor Base Current Limit Value	I _{3LIM}		9	12	16	mA
Thermal Protective Circuit Operating Temperature Balancing Value	T _{THD}		—	159	—	°C
Thermal Protective Circuit Operating Temperature Hysteresis Width	DT _{THD}		—	64	—	°C

Note) The specified values of V_{IOF}, V_{OOF}, G₊, G_R, V_{L+}, V_{L-}, and V_{DZ} are common ones for each of the motor driver 1, motor driver 2, and motor driver 3 circuits.

■ Pin Descriptions (Cont.) (The following description applies when the 3 channels for the motor drivers 1, 2, and 3 are used.)

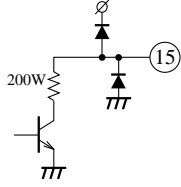
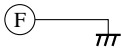
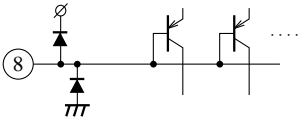
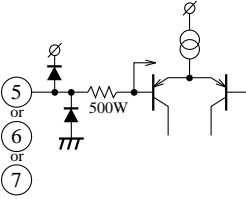
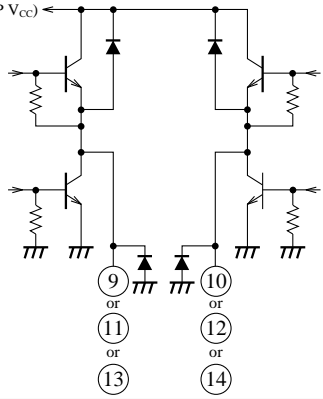
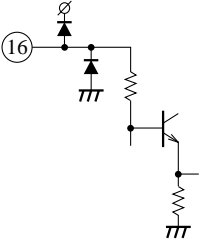
Pin No.	Symbol	I/O	DC Voltage ($V_{CC}/12V$)	Equivalent Circuit	Description	
15	\overline{RST}	O	—		Reset output pin. Open collector output type.	
F	GND	I	0V		GND pin	
8	V_{REF}	I	2.5V		V_{REF} input pin	
5	TVDI	I	2.5V		Driver 1 error input pin	
6	FDI	I	2.5V		Driver 2 error input pin	
7	TDI	I	2.5V		Driver 3 error input pin	
9	TD-	O	(0.3V)		BTL driver 3 inverting output pin	
10	TD+	O	(0.3V)		BTL driver 3 non-inverting output pin	
11	FD-	O	(0.3V)		BTL driver 2 inverting output pin	
12	FD+	O	(0.3V)		BTL driver 2 non-inverting output pin	
13	TVD-	O	(0V)		BTL driver 1 inverting output pin	
14	TVD+	O	(0V)		BTL driver 1 non-inverting output pin	
16	PC	I	0V			PC (power cut) input pin