

Features

- High-performance, Low-power AVR[®] 8-bit Microcontroller
- RISC Architecture
 - 118 Powerful Instructions – Most Single Clock Cycle Execution
 - 32 x 8 General Purpose Working Registers
 - Fully Static Operation
 - Up to 16 MIPS Throughput at 16 MHz
- Data and Non-volatile Program Memory
 - 2K Bytes of In-System Programmable Program Memory Flash
Endurance: 10,000 Write/Erase Cycles
 - 128 Bytes of In-System Programmable EEPROM
Endurance: 100,000 Write/Erase Cycles
 - 128 Bytes Internal SRAM
 - Programming Lock for Flash Program and EEPROM Data Security
- Peripheral Features
 - 8-bit Timer/Counter with Separate Prescaler
 - 8-bit High-speed Timer with Separate Prescaler
 - 2 High Frequency PWM Outputs with Separate Output Compare Registers
 - Non-overlapping Inverted PWM Output Pins
 - Universal Serial Interface with Start Condition Detector
 - 10-bit ADC
 - 11 Single Ended Channels
 - 8 Differential ADC Channels
 - 7 Differential ADC Channel Pairs with Programmable Gain (1x, 20x)
 - On-chip Analog Comparator
 - External Interrupt
 - Pin Change Interrupt on 11 Pins
 - Programmable Watchdog Timer with Separate On-chip Oscillator
- Special Microcontroller Features
 - Low Power Idle, Noise Reduction, and Power-down Modes
 - Power-on Reset and Programmable Brown-out Detection
 - External and Internal Interrupt Sources
 - In-System Programmable via SPI Port
 - Internal Calibrated RC Oscillator
- I/O and Packages
 - 20-lead PDIP/SOIC: 16 Programmable I/O Lines
 - 32-lead MLF: 16 programmable I/O Lines
- Operating Voltages
 - 2.7V - 5.5V for ATtiny26L
 - 4.5V - 5.5V for ATtiny26
- Speed Grades
 - 0 - 8 MHz for ATtiny26L
 - 0 - 16 MHz for ATtiny26
- Power Consumption at 1 MHz, 3V and 25°C for ATtiny26L
 - Active 16 MHz, 5V and 25°C: Typ 15 mA
 - Active 1 MHz, 3V and 25°C: 0.70 mA
 - Idle Mode 1 MHz, 3V and 25°C: 0.18 mA
 - Power-down Mode: < 1 µA



8-bit AVR[®] Microcontroller with 2K Bytes Flash

ATtiny26
ATtiny26L

Summary

Rev. 1477ES-AVR-12/03



Note: This is a summary document. A complete document is available on our Web site at www.atmel.com.

Pin Configuration

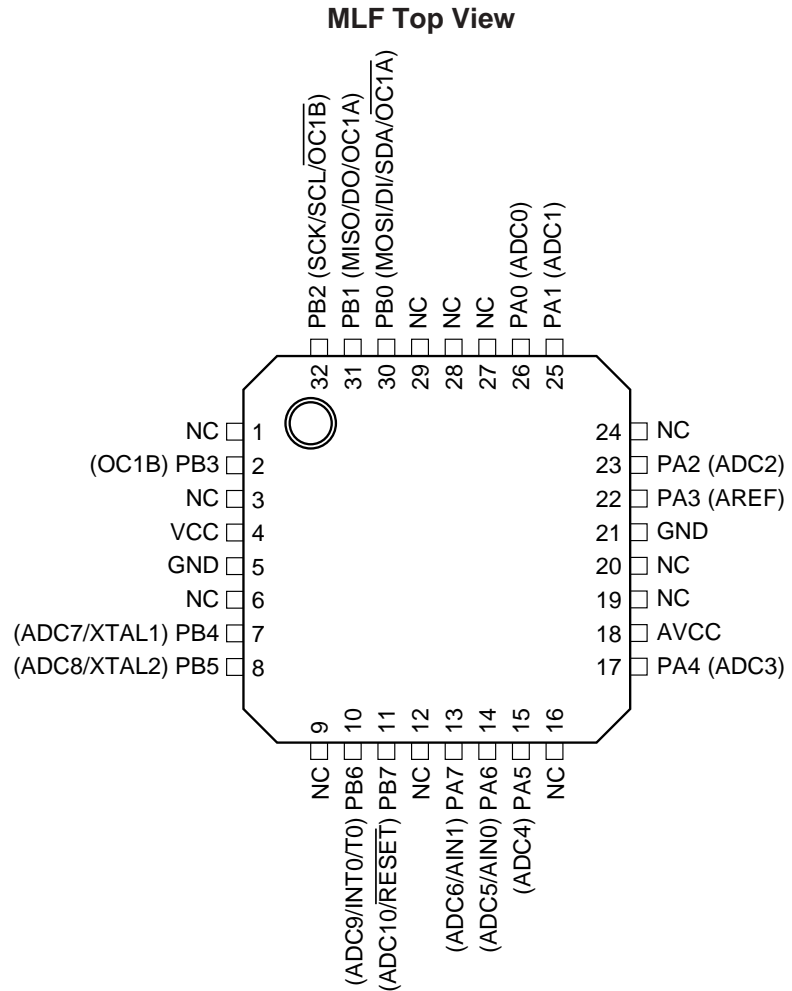
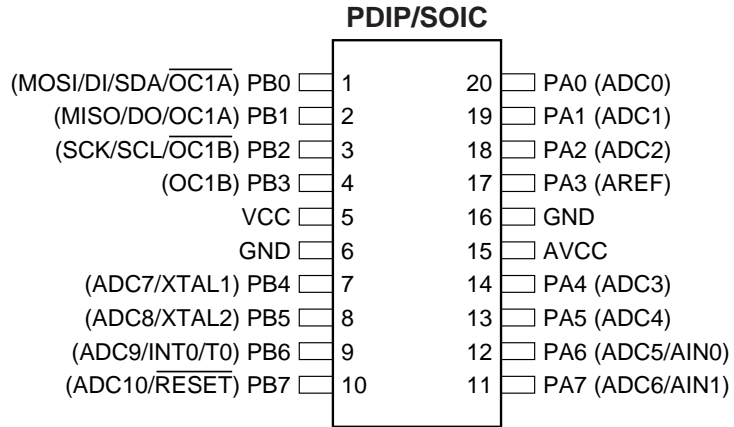

Description

The ATtiny26(L) is a low-power CMOS 8-bit microcontroller based on the AVR enhanced RISC architecture. By executing powerful instructions in a single clock cycle, the ATtiny26(L) achieves throughputs approaching 1 MIPS per MHz allowing the system designer to optimize power consumption versus processing speed.

The AVR core combines a rich instruction set with 32 general purpose working registers. All the 32 registers are directly connected to the Arithmetic Logic Unit (ALU), allowing two independent registers to be accessed in one single instruction executed in one clock cycle. The resulting architecture is more code efficient while achieving throughputs up to ten times faster than conventional CISC microcontrollers. The ATtiny26(L) has a high precision ADC with up to 11 single ended channels and 8 differential channels. Seven differential channels have an optional gain of 20x. Four out of the seven differential channels, which have the optional gain, can be used at the same time. The ATtiny26(L) also has a high frequency 8-bit PWM module with two independent outputs. Two of the PWM outputs have inverted non-overlapping output pins ideal for synchronous rectification. The Universal Serial Interface of the ATtiny26(L) allows efficient software implementation of TWI (Two-wire Serial Interface) or SM-bus interface. These features allow for highly integrated battery charger and lighting ballast applications, low-end thermostats, and fire detectors, among other applications.

The ATtiny26(L) provides 2K bytes of Flash, 128 bytes EEPROM, 128 bytes SRAM, up to 16 general purpose I/O lines, 32 general purpose working registers, two 8-bit Timer/Counters, one with PWM outputs, internal and external Oscillators, internal and external interrupts, programmable Watchdog Timer, 11-channel, 10-bit Analog to Digital Converter with two differential voltage input gain stages, and four software selectable power saving modes. The Idle mode stops the CPU while allowing the Timer/Counters and interrupt system to continue functioning. The ATtiny26(L) also has a dedicated ADC Noise Reduction mode for reducing the noise in ADC conversion. In this sleep mode, only the ADC is functioning. The Power-down mode saves the register contents but freezes the oscillators, disabling all other chip functions until the next interrupt or hardware reset. The Standby mode is the same as the Power-down mode, but external oscillators are enabled. The wakeup or interrupt on pin change features enable the ATtiny26(L) to be highly responsive to external events, still featuring the lowest power consumption while in the Power-down mode.

The device is manufactured using Atmel's high density non-volatile memory technology. By combining an enhanced RISC 8-bit CPU with Flash on a monolithic chip, the ATtiny26(L) is a powerful microcontroller that provides a highly flexible and cost effective solution to many embedded control applications.

The ATtiny26(L) AVR is supported with a full suite of program and system development tools including: Macro assemblers, program debugger/simulators, In-circuit emulators, and evaluation kits.

Block Diagram

Figure 1. The ATtiny26(L) Block Diagram

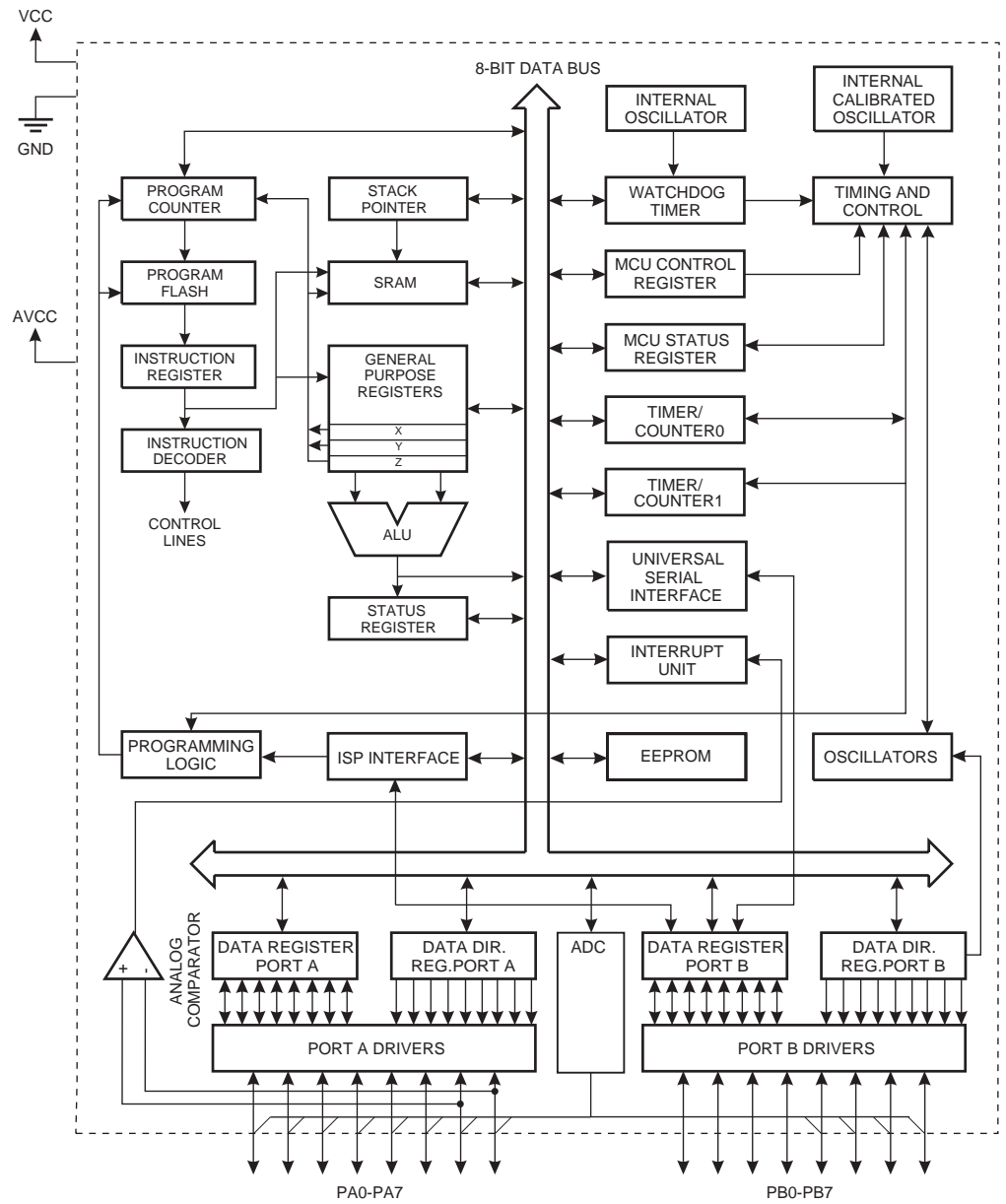

Pin Descriptions

VCC	Digital supply voltage pin.
GND	Digital ground pin.
AVCC	AVCC is the supply voltage pin for Port A and the A/D Converter (ADC). It should be externally connected to V_{CC} , even if the ADC is not used. If the ADC is used, it should be connected to V_{CC} through a low-pass filter. See page 77 for details on operating of the ADC.
Port A (PA7..PA0)	Port A is an 8-bit general purpose I/O port. PA7..PA0 are all I/O pins that can provide internal pull-ups (selected for each bit). Port A has alternate functions as analog inputs for the ADC and analog comparator and pin change interrupt as described in “Alternate Port Functions” on page 95.
Port B (PB7..PB0)	<p>Port B is an 8-bit general purpose I/O port. PB6..0 are all I/O pins that can provide internal pull-ups (selected for each bit). PB7 is an I/O pin if not used as the reset. To use pin PB7 as an I/O pin, instead of RESET pin, program (“0”) RSTDISBL Fuse. Port B has alternate functions for the ADC, clocking, timer counters, USI, SPI programming, and pin change interrupt as described in “Alternate Port Functions” on page 95.</p> <p>An External Reset is generated by a low level on the PB7/$\overline{\text{RESET}}$ pin. Reset pulses longer than 50 ns will generate a reset, even if the clock is not running. Shorter pulses are not guaranteed to generate a reset.</p>
XTAL1	Input to the inverting oscillator amplifier and input to the internal clock operating circuit.
XTAL2	Output from the inverting oscillator amplifier.



Register Summary

Address	Name	Bit 7	Bit 6	Bit 5	Bit 4	Bit 3	Bit 2	Bit 1	Bit 0	Page
\$3F (\$5F)	SREG	I	T	H	S	V	N	Z	C	18
\$3E (\$5E)	Reserved									
\$3D (\$5D)	SP	SP7	SP6	SP5	SP4	SP3	SP2	SP1	SP0	19
\$3C (\$5C)	Reserved									
\$3B (\$5B)	GIMSK	-	INT0	PCIE1	PCIE0	-	-	-	-	34
\$3A (\$5A)	GIFR	-	INTF0	PCIF	-	-	-	-	-	35
\$39 (\$59)	TIMSK	-	OCIE1A	OCIE1B	-	-	TOIE1	TOIE0	-	36
\$38 (\$58)	TIFR	-	OCF1A	OCF1B	-	-	TOV1	TOV0	-	37
\$37 (\$57)	Reserved									
\$36 (\$56)	Reserved									
\$35 (\$55)	MCUCR	-	PUD	SE	SM1	SM0	-	ISC01	ISC00	39
\$34 (\$54)	MCUSR	-	-	-	-	WDRF	BORF	EXTRF	PORF	33
\$33 (\$53)	TCCR0	-	-	-	-	PSR0	CS02	CS01	CS00	46
\$32 (\$52)	TCNT0	Timer/Counter0 (8-Bit)								47
\$31 (\$51)	OSCCAL	Oscillator Calibration Register								31
\$30 (\$50)	TCCR1A	COM1A1	COM1A0	COM1B1	COM1B0	FOC1A	FOC1B	PWM1A	PWM1B	50
\$2F (\$4F)	TCCR1B	CTC1	PSR1	-	-	CS13	CS12	CS11	CS10	51
\$2E (\$4E)	TCNT1	Timer/Counter1 (8-Bit)								52
\$2D (\$4D)	OCR1A	Timer/Counter1 Output Compare Register A (8-Bit)								52
\$2C (\$4C)	OCR1B	Timer/Counter1 Output Compare Register B (8-Bit)								53
\$2B (\$4B)	OCR1C	Timer/Counter1 Output Compare Register C (8-Bit)								53
\$2A (\$4A)	Reserved									
\$29 (\$49)	PLLCSR	-	-	-	-	-	PCKE	PLLE	PLOCK	
\$28 (\$48)	Reserved									
\$27 (\$47)	Reserved									
\$26 (\$46)	Reserved									
\$25 (\$45)	Reserved									
\$24 (\$44)	Reserved									
\$23 (\$43)	Reserved									
\$22 (\$42)	Reserved									
\$21 (\$41)	WDTCR	-	-	-	WDCE	WDE	WDP2	WDP1	WDP0	58
\$20 (\$40)	Reserved									
\$1F (\$3F)	Reserved									
\$1E (\$3E)	EEAR	-	EEAR6	EEAR5	EEAR4	EEAR3	EEAR2	EEAR1	EEAR0	60
\$1D (\$3D)	EEDR	EEPROM Data Register (8-Bit)								60
\$1C (\$3C)	EEDR	-	-	-	-	EERIE	EEMWE	EEWE	EERE	60
\$1B (\$3B)	PORTA	PORTA7	PORTA6	PORTA5	PORTA4	PORTA3	PORTA2	PORTA1	PORTA0	
\$1A (\$3A)	DDRA	DDA7	DDA6	DDA5	DDA4	DDA3	DDA2	DDA1	DDA0	
\$19 (\$39)	PINA	PINA7	PINA6	PINA5	PINA4	PINA3	PINA2	PINA1	PINA0	
\$18 (\$38)	PORTB	PORTB7	PORTB6	PORTB5	PORTB4	PORTB3	PORTB2	PORTB1	PORTB0	
\$17 (\$37)	DDRB	DDB7	DDB6	DDB5	DDB4	DDB3	DDB2	DDB1	DDB0	
\$16 (\$36)	PINB	PINB7	PINB6	PINB5	PINB4	PINB3	PINB2	PINB1	PINB0	
\$15 (\$35)	Reserved									
\$14 (\$34)	Reserved									
\$13 (\$33)	Reserved									
\$12 (\$32)	Reserved									
\$11 (\$31)	Reserved									
\$10 (\$30)	Reserved									
\$0F (\$2F)	USIDR	Universal Serial Interface Data Register (8-Bit)								64
\$0E (\$2E)	USISR	USISIF	USIOIF	USIPF	USIDC	USICNT3	USICNT2	USICNT1	USICNT0	64
\$0D (\$2D)	USICR	USISIE	USIOIE	USIWM1	USIWM0	USICS1	USICS0	USICLK	USITC	65
\$0C (\$2C)	Reserved									
\$0B (\$2B)	Reserved									
\$0A (\$2A)	Reserved									
\$09 (\$29)	Reserved									
\$08 (\$28)	ACSR	ACD	ACBG	ACO	ACI	ACIE	ACME	ACIS1	ACIS0	74
\$07 (\$27)	ADMUX	REFS1	REFS0	ADLAR	MUX4	MUX3	MUX2	MUX1	MUX0	84
\$06 (\$26)	ADCSR	ADEN	ADSC	ADFR	ADIF	ADIE	ADPS2	ADPS1	ADPS0	86
\$05 (\$25)	ADCH	ADC Data Register High Byte								87
\$04 (\$24)	ADCL	ADC Data Register Low Byte								87
...	Reserved									
\$00 (\$20)	Reserved									

Instruction Set Summary

Mnemonic	Operands	Description	Operation	Flags	# Clocks
ARITHMETIC AND LOGIC INSTRUCTIONS					
ADD	Rd, Rr	Add Two Registers	$Rd \leftarrow Rd + Rr$	Z,C,N,V,H	1
ADC	Rd, Rr	Add with Carry Two Registers	$Rd \leftarrow Rd + Rr + C$	Z,C,N,V,H	1
ADIW	Rdl, K	Add Immediate to Word	$Rdh:Rdl \leftarrow Rdh:Rdl + K$	Z,C,N,V,S	2
SUB	Rd, Rr	Subtract Two Registers	$Rd \leftarrow Rd - Rr$	Z,C,N,V,H	1
SUBI	Rd, K	Subtract Constant from Register	$Rd \leftarrow Rd - K$	Z,C,N,V,H	1
SBC	Rd, Rr	Subtract with Carry Two Registers	$Rd \leftarrow Rd - Rr - C$	Z,C,N,V,H	1
SBCI	Rd, K	Subtract with Carry Constant from Reg.	$Rd \leftarrow Rd - K - C$	Z,C,N,V,H	1
SBIW	Rdl, K	Subtract Immediate from Word	$Rdh:Rdl \leftarrow Rdh:Rdl - K$	Z,C,N,V,S	2
AND	Rd, Rr	Logical AND Registers	$Rd \leftarrow Rd \bullet Rr$	Z,N,V	1
ANDI	Rd, K	Logical AND Register and Constant	$Rd \leftarrow Rd \bullet K$	Z,N,V	1
OR	Rd, Rr	Logical OR Registers	$Rd \leftarrow Rd \vee Rr$	Z,N,V	1
ORI	Rd, K	Logical OR Register and Constant	$Rd \leftarrow Rd \vee K$	Z,N,V	1
EOR	Rd, Rr	Exclusive OR Registers	$Rd \leftarrow Rd \oplus Rr$	Z,N,V	1
COM	Rd	One's Complement	$Rd \leftarrow \$FF - Rd$	Z,C,N,V	1
NEG	Rd	Two's Complement	$Rd \leftarrow \$00 - Rd$	Z,C,N,V,H	1
SBR	Rd, K	Set Bit(s) in Register	$Rd \leftarrow Rd \vee K$	Z,N,V	1
CBR	Rd, K	Clear Bit(s) in Register	$Rd \leftarrow Rd \bullet (\$FF - K)$	Z,N,V	1
INC	Rd	Increment	$Rd \leftarrow Rd + 1$	Z,N,V	1
DEC	Rd	Decrement	$Rd \leftarrow Rd - 1$	Z,N,V	1
TST	Rd	Test for Zero or Minus	$Rd \leftarrow Rd \bullet Rd$	Z,N,V	1
CLR	Rd	Clear Register	$Rd \leftarrow Rd \oplus Rd$	Z,N,V	1
SER	Rd	Set Register	$Rd \leftarrow \$FF$	None	1
BRANCH INSTRUCTIONS					
RJMP	k	Relative Jump	$PC \leftarrow PC + k + 1$	None	2
IJMP		Indirect Jump to (Z)	$PC \leftarrow Z$	None	2
RCALL	k	Relative Subroutine Call	$PC \leftarrow PC + k + 1$	None	3
ICALL		Indirect Call to (Z)	$PC \leftarrow Z$	None	3
RET		Subroutine Return	$PC \leftarrow STACK$	None	4
RETI		Interrupt Return	$PC \leftarrow STACK$	I	4
CPSE	Rd, Rr	Compare, Skip if Equal	if $(Rd = Rr)$ $PC \leftarrow PC + 2$ or 3	None	1/2/3
CP	Rd, Rr	Compare	$Rd - Rr$	Z,N,V,C,H	1
CPC	Rd, Rr	Compare with Carry	$Rd - Rr - C$	Z,N,V,C,H	1
CPI	Rd, K	Compare Register with Immediate	$Rd - K$	Z,N,V,C,H	1
SBRC	Rr, b	Skip if Bit in Register Cleared	if $(Rr(b) = 0)$ $PC \leftarrow PC + 2$ or 3	None	1/2/3
SBRS	Rr, b	Skip if Bit in Register is Set	if $(Rr(b) = 1)$ $PC \leftarrow PC + 2$ or 3	None	1/2/3
SBIC	P, b	Skip if Bit in I/O Register Cleared	if $(P(b) = 0)$ $PC \leftarrow PC + 2$ or 3	None	1/2/3
SBIS	P, b	Skip if Bit in I/O Register is Set	if $(P(b) = 1)$ $PC \leftarrow PC + 2$ or 3	None	1/2/3
BRBS	s, k	Branch if Status Flag Set	if $(SREG(s) = 1)$ then $PC \leftarrow PC + k + 1$	None	1/2
BRBC	s, k	Branch if Status Flag Cleared	if $(SREG(s) = 0)$ then $PC \leftarrow PC + k + 1$	None	1/2
BREQ	k	Branch if Equal	if $(Z = 1)$ then $PC \leftarrow PC + k + 1$	None	1/2
BRNE	k	Branch if Not Equal	if $(Z = 0)$ then $PC \leftarrow PC + k + 1$	None	1/2
BRCS	k	Branch if Carry Set	if $(C = 1)$ then $PC \leftarrow PC + k + 1$	None	1/2
BRCC	k	Branch if Carry Cleared	if $(C = 0)$ then $PC \leftarrow PC + k + 1$	None	1/2
BRSH	k	Branch if Same or Higher	if $(C = 0)$ then $PC \leftarrow PC + k + 1$	None	1/2
BRLO	k	Branch if Lower	if $(C = 1)$ then $PC \leftarrow PC + k + 1$	None	1/2
BRMI	k	Branch if Minus	if $(N = 1)$ then $PC \leftarrow PC + k + 1$	None	1/2
BRPL	k	Branch if Plus	if $(N = 0)$ then $PC \leftarrow PC + k + 1$	None	1/2
BRGE	k	Branch if Greater or Equal, Signed	if $(N \oplus V = 0)$ then $PC \leftarrow PC + k + 1$	None	1/2
BRLT	k	Branch if Less than Zero, Signed	if $(N \oplus V = 1)$ then $PC \leftarrow PC + k + 1$	None	1/2
BRHS	k	Branch if Half-carry Flag Set	if $(H = 1)$ then $PC \leftarrow PC + k + 1$	None	1/2
BRHC	k	Branch if Half-carry Flag Cleared	if $(H = 0)$ then $PC \leftarrow PC + k + 1$	None	1/2
BRTS	k	Branch if T-flag Set	if $(T = 1)$ then $PC \leftarrow PC + k + 1$	None	1/2
BRTC	k	Branch if T-flag Cleared	if $(T = 0)$ then $PC \leftarrow PC + k + 1$	None	1/2
BRVS	k	Branch if Overflow Flag is Set	if $(V = 1)$ then $PC \leftarrow PC + k + 1$	None	1/2
BRVC	k	Branch if Overflow Flag is Cleared	if $(V = 0)$ then $PC \leftarrow PC + k + 1$	None	1/2
BRIE	k	Branch if Interrupt Enabled	if $(I = 1)$ then $PC \leftarrow PC + k + 1$	None	1/2
BRID	k	Branch if Interrupt Disabled	if $(I = 0)$ then $PC \leftarrow PC + k + 1$	None	1/2
DATA TRANSFER INSTRUCTIONS					
MOV	Rd, Rr	Move between Registers	$Rd \leftarrow Rr$	None	1
LDI	Rd, K	Load Immediate	$Rd \leftarrow K$	None	1
LD	Rd, X	Load Indirect	$Rd \leftarrow (X)$	None	2
LD	Rd, X+	Load Indirect and Post-inc.	$Rd \leftarrow (X), X \leftarrow X + 1$	None	2
LD	Rd, -X	Load Indirect and Pre-dec.	$X \leftarrow X - 1, Rd \leftarrow (X)$	None	2

Instruction Set Summary (Continued)

Mnemonic	Operands	Description	Operation	Flags	# Clocks
LD	Rd, Y	Load Indirect	$Rd \leftarrow (Y)$	None	2
LD	Rd, Y+	Load Indirect and Post-inc.	$Rd \leftarrow (Y), Y \leftarrow Y + 1$	None	2
LD	Rd, -Y	Load Indirect and Pre-dec.	$Y \leftarrow Y - 1, Rd \leftarrow (Y)$	None	2
LDD	Rd, Y+q	Load Indirect with Displacement	$Rd \leftarrow (Y + q)$	None	2
LD	Rd, Z	Load Indirect	$Rd \leftarrow (Z)$	None	2
LD	Rd, Z+	Load Indirect and Post-inc.	$Rd \leftarrow (Z), Z \leftarrow Z + 1$	None	2
LD	Rd, -Z	Load Indirect and Pre-dec.	$Z \leftarrow Z - 1, Rd \leftarrow (Z)$	None	2
LDD	Rd, Z+q	Load Indirect with Displacement	$Rd \leftarrow (Z + q)$	None	2
LDS	Rd, k	Load Direct from SRAM	$Rd \leftarrow (k)$	None	2
ST	X, Rr	Store Indirect	$(X) \leftarrow Rr$	None	2
ST	X+, Rr	Store Indirect and Post-inc.	$(X) \leftarrow Rr, X \leftarrow X + 1$	None	2
ST	-X, Rr	Store Indirect and Pre-dec.	$X \leftarrow X - 1, (X) \leftarrow Rr$	None	2
ST	Y, Rr	Store Indirect	$(Y) \leftarrow Rr$	None	2
ST	Y+, Rr	Store Indirect and Post-inc.	$(Y) \leftarrow Rr, Y \leftarrow Y + 1$	None	2
ST	-Y, Rr	Store Indirect and Pre-dec.	$Y \leftarrow Y - 1, (Y) \leftarrow Rr$	None	2
STD	Y+q, Rr	Store Indirect with Displacement	$(Y + q) \leftarrow Rr$	None	2
ST	Z, Rr	Store Indirect	$(Z) \leftarrow Rr$	None	2
ST	Z+, Rr	Store Indirect and Post-inc.	$(Z) \leftarrow Rr, Z \leftarrow Z + 1$	None	2
ST	-Z, Rr	Store Indirect and Pre-dec.	$Z \leftarrow Z - 1, (Z) \leftarrow Rr$	None	2
STD	Z+q, Rr	Store Indirect with Displacement	$(Z + q) \leftarrow Rr$	None	2
STS	k, Rr	Store Direct to SRAM	$(k) \leftarrow Rr$	None	2
LPM		Load Program Memory	$R0 \leftarrow (Z)$	None	3
LPM	Rd, Z	Load Program Memory	$Rd \leftarrow (Z)$	None	3
IN	Rd, P	In Port	$Rd \leftarrow P$	None	1
OUT	P, Rr	Out Port	$P \leftarrow Rr$	None	1
PUSH	Rr	Push Register on Stack	$STACK \leftarrow Rr$	None	2
POP	Rd	Pop Register from Stack	$Rd \leftarrow STACK$	None	2
BIT AND BIT-TEST INSTRUCTIONS					
SBI	P, b	Set Bit in I/O Register	$I/O(P,b) \leftarrow 1$	None	2
CBI	P, b	Clear Bit in I/O Register	$I/O(P,b) \leftarrow 0$	None	2
LSL	Rd	Logical Shift Left	$Rd(n+1) \leftarrow Rd(n), Rd(0) \leftarrow 0$	Z,C,N,V	1
LSR	Rd	Logical Shift Right	$Rd(n) \leftarrow Rd(n+1), Rd(7) \leftarrow 0$	Z,C,N,V	1
ROL	Rd	Rotate Left through Carry	$Rd(0) \leftarrow C, Rd(n+1) \leftarrow Rd(n), C \leftarrow Rd(7)$	Z,C,N,V	1
ROR	Rd	Rotate Right through Carry	$Rd(7) \leftarrow C, Rd(n) \leftarrow Rd(n+1), C \leftarrow Rd(0)$	Z,C,N,V	1
ASR	Rd	Arithmetic Shift Right	$Rd(n) \leftarrow Rd(n+1), n = 0..6$	Z,C,N,V	1
SWAP	Rd	Swap Nibbles	$Rd(3..0) \leftarrow Rd(7..4), Rd(7..4) \leftarrow Rd(3..0)$	None	1
BSET	s	Flag Set	$SREG(s) \leftarrow 1$	SREG(s)	1
BCLR	s	Flag Clear	$SREG(s) \leftarrow 0$	SREG(s)	1
BST	Rr, b	Bit Store from Register to T	$T \leftarrow Rr(b)$	T	1
BLD	Rd, b	Bit Load from T to Register	$Rd(b) \leftarrow T$	None	1
SEC		Set Carry	$C \leftarrow 1$	C	1
CLC		Clear Carry	$C \leftarrow 0$	C	1
SEN		Set Negative Flag	$N \leftarrow 1$	N	1
CLN		Clear Negative Flag	$N \leftarrow 0$	N	1
SEZ		Set Zero Flag	$Z \leftarrow 1$	Z	1
CLZ		Clear Zero Flag	$Z \leftarrow 0$	Z	1
SEI		Global Interrupt Enable	$I \leftarrow 1$	I	1
CLI		Global Interrupt Disable	$I \leftarrow 0$	I	1
SES		Set Signed Test Flag	$S \leftarrow 1$	S	1
CLS		Clear Signed Test Flag	$S \leftarrow 0$	S	1
SEV		Set Two's Complement Overflow	$V \leftarrow 1$	V	1
CLV		Clear Two's Complement Overflow	$V \leftarrow 0$	V	1
SET		Set T in SREG	$T \leftarrow 1$	T	1
CLT		Clear T in SREG	$T \leftarrow 0$	T	1
SEH		Set Half-carry Flag in SREG	$H \leftarrow 1$	H	1
CLH		Clear Half-carry Flag in SREG	$H \leftarrow 0$	H	1
NOP		No Operation		None	1
SLEEP		Sleep	(see specific descr. for Sleep function)	None	1
WDR		Watchdog Reset	(see specific descr. for WDR/timer)	None	1

Ordering Information⁽¹⁾

Speed (MHz)	Power Supply	Ordering Code	Package	Operation Range
8	2.7 - 5.5V	ATtiny26L-8PC ATtiny26L-8SC ATtiny26L-8MC	20P3 20S 32M1-A	Commercial (0°C to 70°C)
		ATtiny26L-8PI ATtiny26L-8SI ATtiny26L-8MI	20P3 20S 32M1-A	Industrial (-40°C to 85°C)
16	4.5 - 5.5V	ATtiny26-16PC ATtiny26-16SC ATtiny26-16MC	20P3 20S 32M1-A	Commercial (0°C to 70°C)
		ATtiny26-16PI ATtiny26-16SI ATtiny26-16MI	20P3 20S 32M1-A	Industrial (-40°C to 85°C)

Note: 1. This device can also be supplied in wafer form. Please contact your local Atmel sales office for detailed ordering information and minimum quantities.



Package Type	
20P3	20-lead, 0.300" Wide, Plastic Dual Inline Package (PDIP)
20S	20-lead, 0.300" Wide, Plastic Gull Wing Small Outline (SOIC)
32M1-A	32-pad, 5 x 5 x 1.0 body, Lead Pitch 0.50 mm Micro Lead Frame Package (MLF)

Packaging Information

20P3

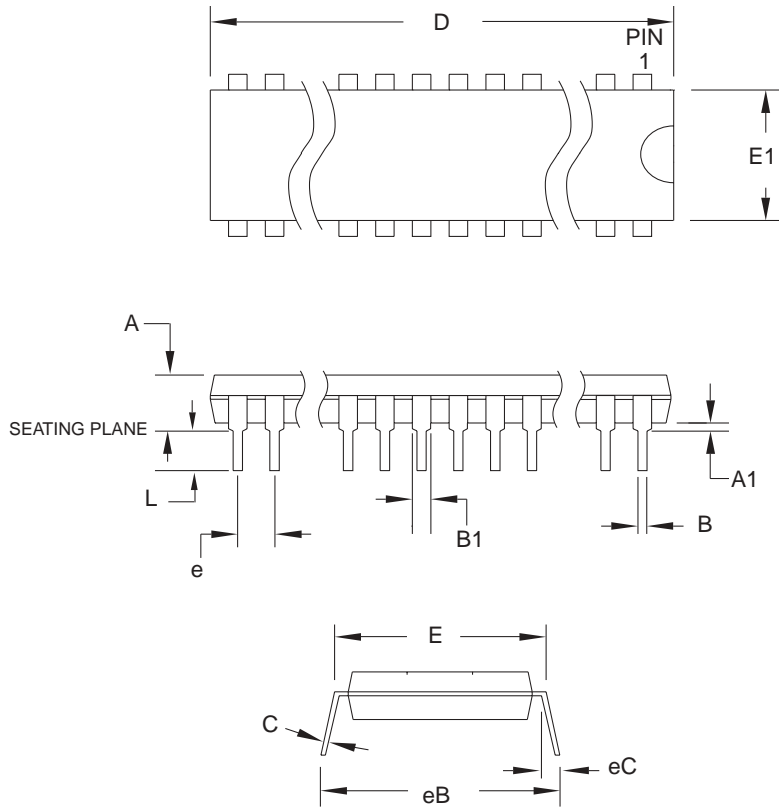

COMMON DIMENSIONS
(Unit of Measure = mm)

SYMBOL	MIN	NOM	MAX	NOTE
A	–	–	5.334	
A1	0.381	–	–	
D	25.984	–	25.493	Note 2
E	7.620	–	8.255	
E1	6.096	–	7.112	Note 2
B	0.356	–	0.559	
B1	1.270	–	1.551	
L	2.921	–	3.810	
C	0.203	–	0.356	
eB	–	–	10.922	
eC	0.000	–	1.524	
e	2.540 TYP			

- Notes: 1. This package conforms to JEDEC reference MS-001, Variation AD.
 2. Dimensions D and E1 do not include mold Flash or Protrusion.
 Mold Flash or Protrusion shall not exceed 0.25 mm (0.010").

09/28/01

ATMEL 2325 Orchard Parkway
San Jose, CA 95131

TITLE
20P3, 20-lead (0.300"/7.62 mm Wide) Plastic Dual
Inline Package (PDIP)

DRAWING NO.
20P3

REV.
B

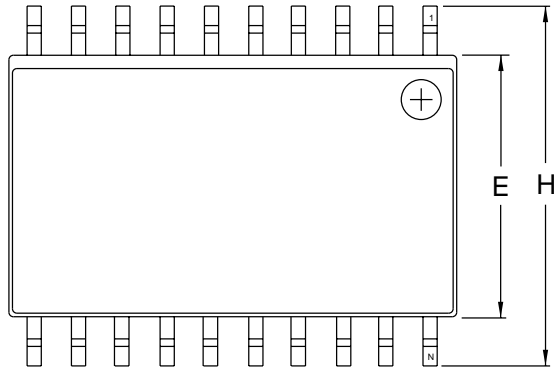

Top View

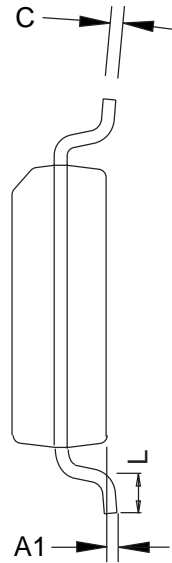

End View

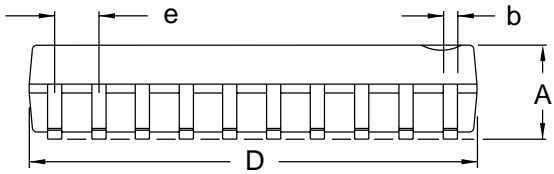

Side View

COMMON DIMENSIONS
(Unit of Measure = inches)

SYMBOL	MIN	NOM	MAX	NOTE
A	0.0926		0.1043	
A1	0.0040		0.0118	
b	0.0130		0.0200	4
C	0.0091		0.0125	
D	0.4961		0.5118	1
E	0.2914		0.2992	2
H	0.3940		0.4190	
L	0.0160		0.050	3
e	0.050 BSC			

- Notes:
1. This drawing is for general information only; refer to JEDEC Drawing MS-013, Variation AC for additional information.
 2. Dimension "D" does not include mold Flash, protrusions or gate burrs. Mold Flash, protrusions and gate burrs shall not exceed 0.15 mm (0.006") per side.
 3. Dimension "E" does not include inter-lead Flash or protrusion. Inter-lead Flash and protrusions shall not exceed 0.25 mm (0.010") per side.
 4. "L" is the length of the terminal for soldering to a substrate.
 5. The lead width "b", as measured 0.36 mm (0.014") or greater above the seating plane, shall not exceed a maximum value of 0.61 mm (0.024") per side.



2325 Orchard Parkway
San Jose, CA 95131

TITLE
20S2, 20-lead, 0.300" Wide Body, Plastic Gull
Wing Small Outline Package (SOIC)

DRAWING NO.
20S2

REV.
A

32M1-A

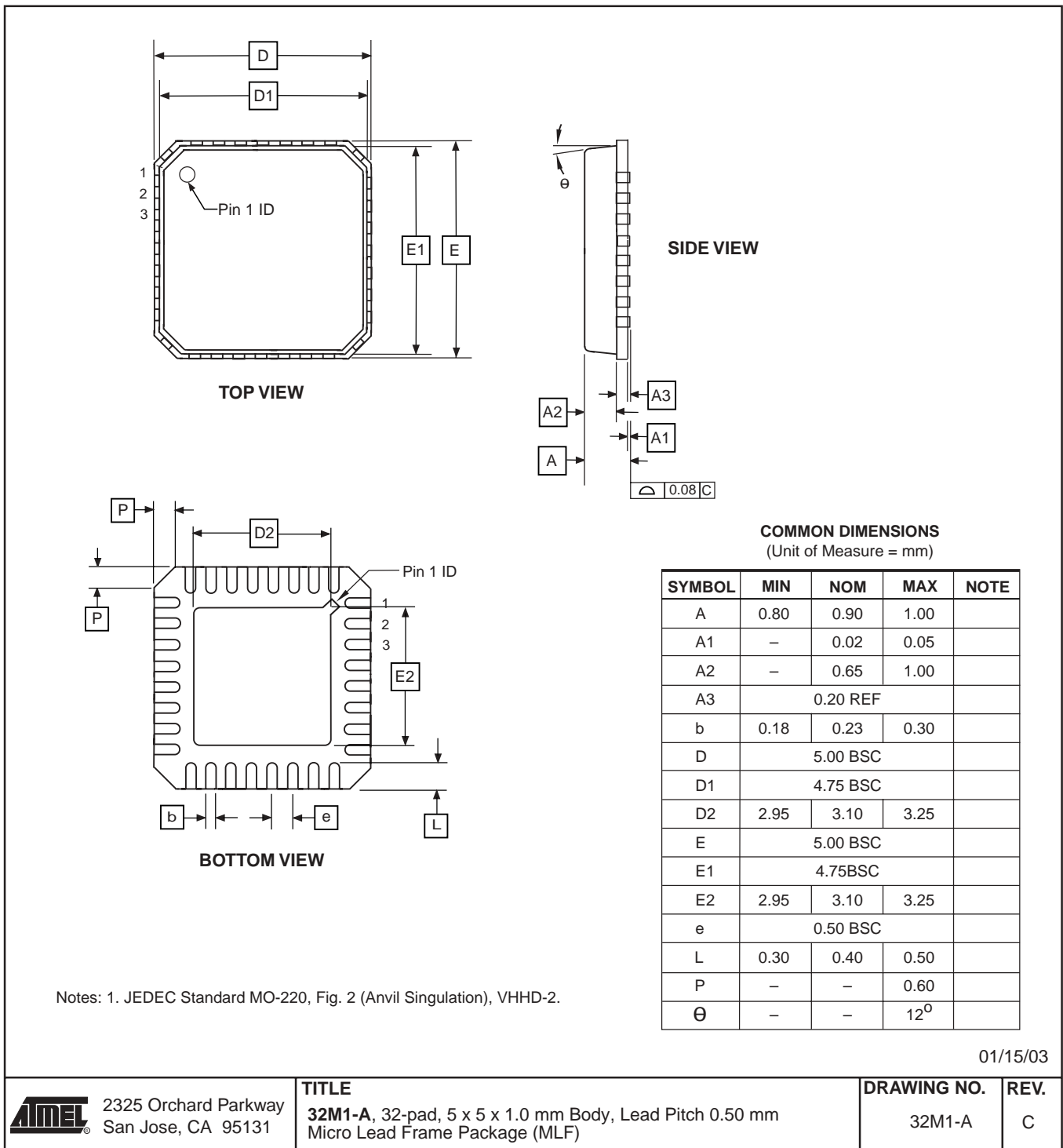

Datasheet Change Log for ATtiny26

Changes from Rev. 1477D-05/03 to Rev. 1477E-10/03

Please note that the referring page numbers in this section are referred to this document. The referring revision in this section are referring to the document revision.

1. Removed Preliminary references.
2. Updated “Features” on page 1.
3. Removed SSOP package reference from “Pin Configuration” on page 2.
4. Updated V_{RST} and t_{RST} in Table 3 on page 22.
5. Updated “Calibrated Internal RC Oscillator” on page 31.
6. Updated DC Characteristics for V_{OL} , I_{IL} , I_{IH} , I_{CC} Power Down and V_{ACIO} in “Electrical Characteristics” on page 125.
7. Updated V_{INT} , INL and Gain Error in “ADC Characteristics” on page 128 and page 129. Fixed typo in “Absolute Accuracy” on page 129.
8. Added Figure 106 in “Pin Driver Strength” on page 145, Figure 120, Figure 121 and Figure 122 in “BOD Thresholds and Analog Comparator Offset” on page 154. Updated Figure 117 and Figure 118.
9. Removed LPM Rd, Z+ from “Instruction Set Summary” on page 7. This instruction is not supported in ATtiny26.

Changes from Rev. 1477C-09/02 to Rev. 1477D-05/03

1. Updated “Packaging Information” on page 11.
2. Removed ADHSM from “ADC Characteristics” on page 128.
3. Added section “EEPROM Write During Power-down Sleep Mode” on page 62.
4. Added section “Default Clock Source” on page 28.
5. Corrected PLL Lock value in the “Bit 0 – PLOCK: PLL Lock Detector” on page 54.
6. Added information about conversion time when selecting differential channels on page 80.
7. Corrected {DDxn, PORTxn} value on page 92.
8. Added section “Unconnected Pins” on page 95.
9. Added note for RSTDISBL Fuse in Table 49 on page 107.
10. Corrected DATA value in Figure 61 on page 115.
11. Added WD_FUSE period in Table 59 on page 122.
12. Updated “ADC Characteristics” on page 128 and added Table 64, “ADC Characteristics, Differential Channels, $T_A = -40^{\circ}\text{C}$ to 85°C ,” on page 129.

13. Updated “ATtiny26 Typical Characteristics” on page 130.
14. Added LPM Rd, Z and LPM Rd, Z+ in “Instruction Set Summary” on page 7.

**Changes from Rev.
1477B-04/02 to Rev.
1477C-09/02**

1. Changed the Endurance on the Flash to 10,000 Write/Erase Cycles.

**Changes from Rev.
1477A-03/02 to Rev.
1477B-04/02**

1. Removed all references to Power Save sleep mode in the section “System Clock and Clock Options” on page 25.
2. Updated the section “Analog to Digital Converter” on page 77 with more details on how to read the conversion result for both differential and single-ended conversion.
3. Updated “Ordering Information⁽¹⁾” on page 9 and added MLF package information.



Atmel Corporation

2325 Orchard Parkway
San Jose, CA 95131, USA
Tel: 1(408) 441-0311
Fax: 1(408) 487-2600

Regional Headquarters

Europe

Atmel Sarl
Route des Arsenalux 41
Case Postale 80
CH-1705 Fribourg
Switzerland
Tel: (41) 26-426-5555
Fax: (41) 26-426-5500

Asia

Room 1219
Chinachem Golden Plaza
77 Mody Road Tsimshatsui
East Kowloon
Hong Kong
Tel: (852) 2721-9778
Fax: (852) 2722-1369

Japan

9F, Tonetsu Shinkawa Bldg.
1-24-8 Shinkawa
Chuo-ku, Tokyo 104-0033
Japan
Tel: (81) 3-3523-3551
Fax: (81) 3-3523-7581

Atmel Operations

Memory

2325 Orchard Parkway
San Jose, CA 95131, USA
Tel: 1(408) 441-0311
Fax: 1(408) 436-4314

Microcontrollers

2325 Orchard Parkway
San Jose, CA 95131, USA
Tel: 1(408) 441-0311
Fax: 1(408) 436-4314

La Chantrerie
BP 70602
44306 Nantes Cedex 3, France
Tel: (33) 2-40-18-18-18
Fax: (33) 2-40-18-19-60

ASIC/ASSP/Smart Cards

Zone Industrielle
13106 Rousset Cedex, France
Tel: (33) 4-42-53-60-00
Fax: (33) 4-42-53-60-01

1150 East Cheyenne Mtn. Blvd.
Colorado Springs, CO 80906, USA
Tel: 1(719) 576-3300
Fax: 1(719) 540-1759

Scottish Enterprise Technology Park
Maxwell Building
East Kilbride G75 0QR, Scotland
Tel: (44) 1355-803-000
Fax: (44) 1355-242-743

RF/Automotive

Theresienstrasse 2
Postfach 3535
74025 Heilbronn, Germany
Tel: (49) 71-31-67-0
Fax: (49) 71-31-67-2340

1150 East Cheyenne Mtn. Blvd.
Colorado Springs, CO 80906, USA
Tel: 1(719) 576-3300
Fax: 1(719) 540-1759

Biometrics/Imaging/Hi-Rel MPU/ High Speed Converters/RF Datacom

Avenue de Rochepleine
BP 123
38521 Saint-Egreve Cedex, France
Tel: (33) 4-76-58-30-00
Fax: (33) 4-76-58-34-80

Literature Requests

www.atmel.com/literature

Disclaimer: Atmel Corporation makes no warranty for the use of its products, other than those expressly contained in the Company's standard warranty which is detailed in Atmel's Terms and Conditions located on the Company's web site. The Company assumes no responsibility for any errors which may appear in this document, reserves the right to change devices or specifications detailed herein at any time without notice, and does not make any commitment to update the information contained herein. No licenses to patents or other intellectual property of Atmel are granted by the Company in connection with the sale of Atmel products, expressly or by implication. Atmel's products are not authorized for use as critical components in life support devices or systems.

© Atmel Corporation 2003. All rights reserved. Atmel[®] and combinations thereof, AVR[®], and AVR Studio[®] are the registered trademarks of Atmel Corporation or its subsidiaries. Microsoft[®], Windows[®], Windows NT[®], and Windows XP[®] are the registered trademarks of Microsoft Corporation. Other terms and product names may be the trademarks of others



Printed on recycled paper.

1477ES-AVR-12/03