

UTC MC4556 LINEAR INTEGRATED CIRCUIT

DUAL OPERATIONAL AMPLIFIER

DESCRIPTION

The UTC MC4556 integrated circuit is a high-gain, high output current dual operational amplifier capable of driving $\pm 70\text{mA}$ into 150Ω loads ($\pm 10.5\text{V}$ output voltage), and operating low supply voltage ($V^+/V^- = \pm 2\text{V}$).

The UTC MC4556 combines many of the features of the popular UTC MC4558 as well as having the capability of driving 150Ω loads. In addition, the wide band-width, low noise, high slew rate and low distortion of the UTC MC4556 make it ideal for many audio, telecommunications and instrumentation applications.

FEATURES

- *Operating Voltage ($\pm 2\text{V} \sim \pm 18\text{V}$)
- *High Output Current ($I_o = 70\text{mA}$)
- *Slew Rate ($3\text{V} / \mu\text{s}$ typ.)
- *Gain Band Width Product (8MHz typ.)
- *Bipolar Technology

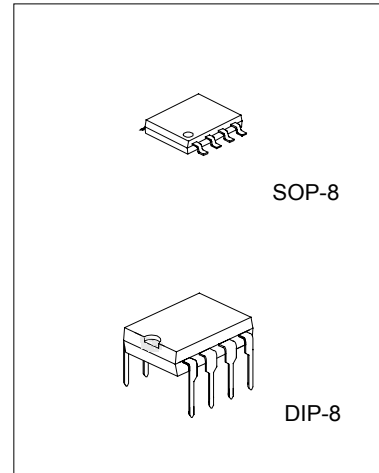

*Pb-free plating product number: MC4556L

ORDERING INFORMATION

Order Number		Package	Packing
Normal	Lead free		
MC4556-S08-R	MC4556L-S08-R	SOP-8	Tape Reel
MC4556-S08-T	MC4556L-S08-T	SOP-8	Tube
MC4556-D08-T	MC4556L-D08-T	DIP-8	Tube

UTC MC4556 LINEAR INTEGRATED CIRCUIT

PIN CONFIGURATION

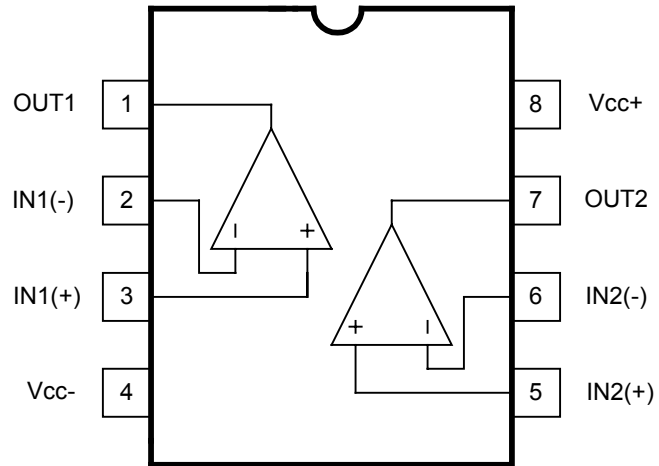

UTC MC4556 LINEAR INTEGRATED CIRCUIT

BLOCK DIAGRAM

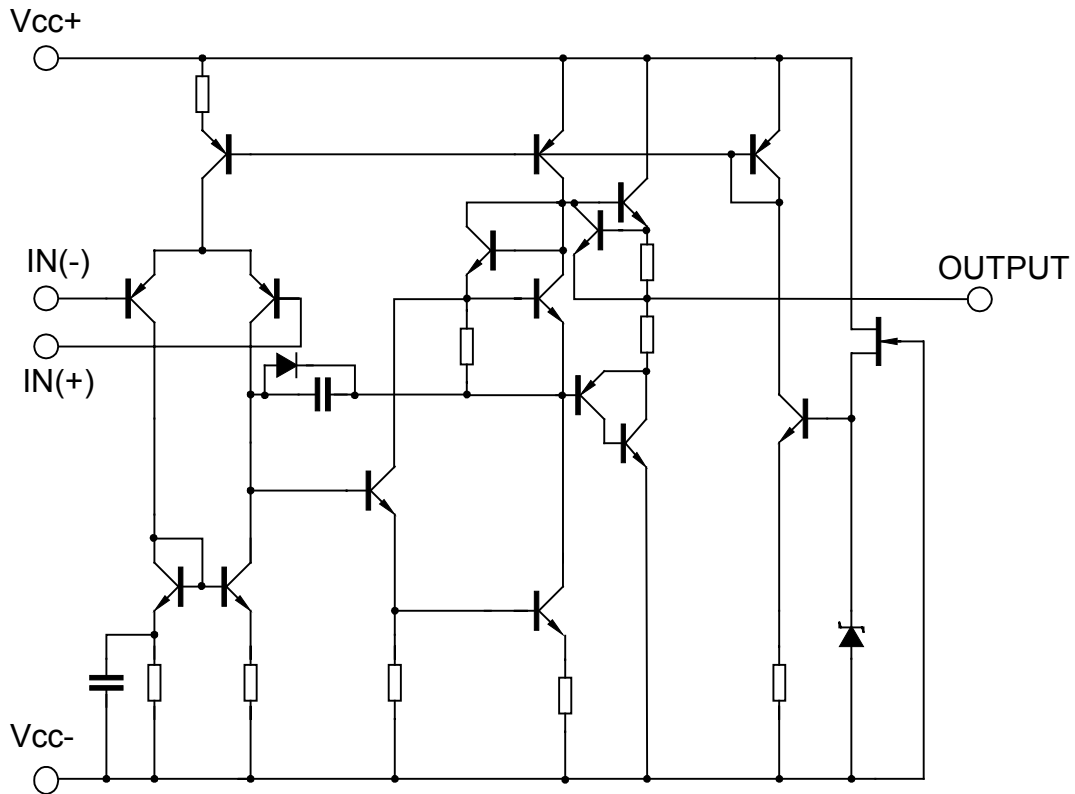

ABSOLUTE MAXIMUM RATINGS (Ta=25°C)

PARAMETER	SYMBOL	RATINGS	UNIT
Supply Voltage	V+/V-	±18	V
Differential Input Voltage	V _{ID}	±30	V
Input Voltage	V _I	±15(note)	V
Power Dissipation	P _D		
DIP-8		700	mW
SOP-8		300	mW
Operating Temperature Range	T _{OPR}	-20 ~ +75	°C
Storage Temperature Range	T _{STG}	-40 ~ +125	°C

Note: For supply voltage less than ±15V, the absolute maximum input voltage is equal to the supply voltage.

UTC MC4556 LINEAR INTEGRATED CIRCUIT

ELECTRICAL CHARACTERISTICS (Ta=25°C, V+ / V- = ±15V)

PARAMETER	SYMBOL	TEST CONDUCTION	MIN	TYP	MAX	UNIT
Input offset voltage	V _{IO}	R _s ≤ 10kΩ	-	0.5	6	mV
Input offset current	I _{IO}		-	5	60	nA
Input bias current	I _B		-	50	500	nA
Input Resistance	R _{IN}		0.3	5	-	MΩ
Large Signal Voltage Gain	A _V	R _L ≥ 2kΩ, V _o = ±10V	86	100	-	dB
Maximum Output Voltage 1	V _{OM1}	R _L ≥ 2kΩ	±12.0	±13.5	-	V
Maximum Output Voltage 2	V _{OM2}	R _L ≥ 150Ω	±10.5	±11.0	-	V
Input Common Mode Voltage Range	V _{ICM}		±13.5	±14.0	-	V
Common Mode Rejection Ratio	CMR	R _s ≤ 10kΩ	70	90	-	dB
Supply Voltage Rejection Ratio	SVR	R _s ≤ 10kΩ	76.5	90	-	dB
Operating Current	I _{CC}		-	9	12	mA
Slew Rate	SR		-	3	-	V/μs
Unity Gain Bandwidth	GB		-	8	-	MHz

UTC MC4556 LINEAR INTEGRATED CIRCUIT

TYPICAL CHARACTERISTICS

MAXIMUM OUTPUT VOLTAGE SWING vs. FREQUENCY
($V_+/V_- = \pm 15V$, $R_L = 2k\Omega$, $T_a = 25^\circ C$)

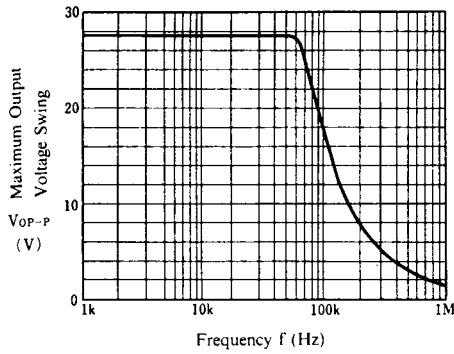

MAXIMUM OUTPUT VOLTAGE SWING vs. FREQUENCY
($V_+/V_- = \pm 15V$, $R_L = 150\Omega$, $T_a = 25^\circ C$)

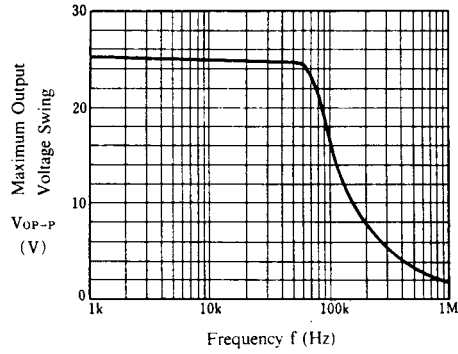

MAXIMUM OUTPUT VOLTAGE SWING vs. OUTPUT CURRENT
($V_+/V_- = \pm 15V$, $T_a = 25^\circ C$)

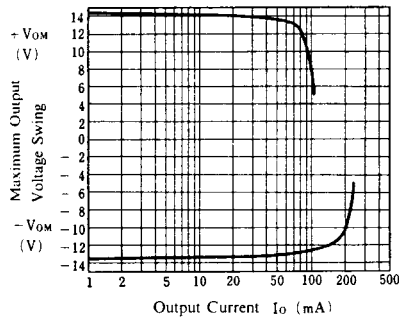

VOLTAGE GAIN, PLASE SHIFT vs. FREQUENCY
($V_+/V_- = \pm 15V$, $R_L = 2k\Omega$, 40dB Amp, $T_a = 25^\circ C$)

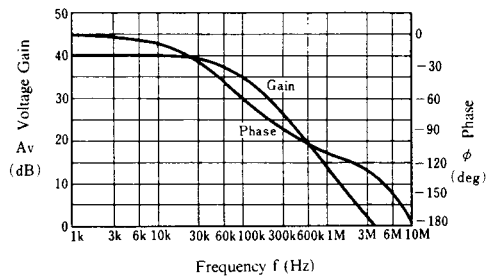

MAXIMUM OUTPUT VOLTAGE SWING vs. OPERATING VOLTAGE
($R_L = 150\Omega$, $T_a = 25^\circ C$)

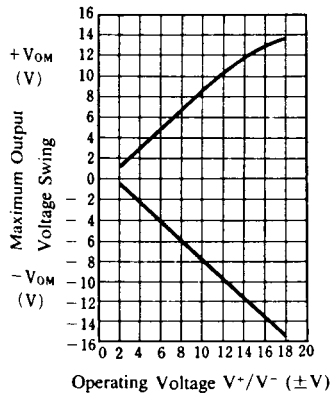

TOTAL HARMONIC DISTORTION vs. OUTPUT VOLTAGE
($V_+/V_- = \pm 15V$, $R_L = 200\Omega$, GAIN=30dB, $T_a = 25^\circ C$)

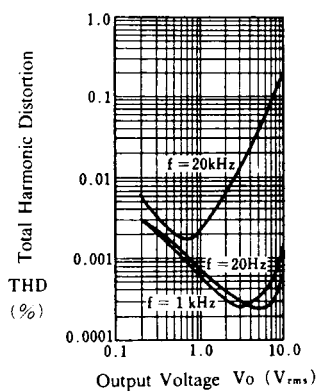

UTC MC4556 LINEAR INTEGRATED CIRCUIT

MAXIMUM OUTPUT VOLTAGE SWING vs. TEMPERATURE
($V^+/V^- = \pm 15V$, $R_L = 2k\Omega$)

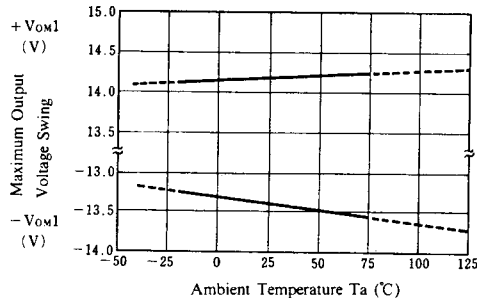

MAXIMUM OUTPUT VOLTAGE SWING vs. TEMPERATURE
($V^+/V^- = \pm 15V$, $R_L = 150\Omega$)

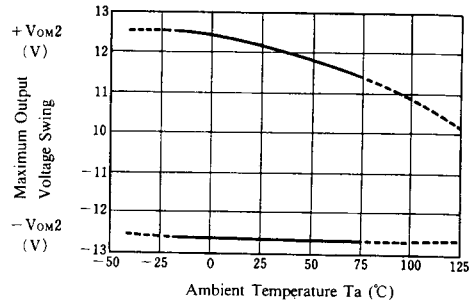

INPUT OFFSET VOLTAGE vs. TEMPERATURE
($V^+/V^- = \pm 15V$)

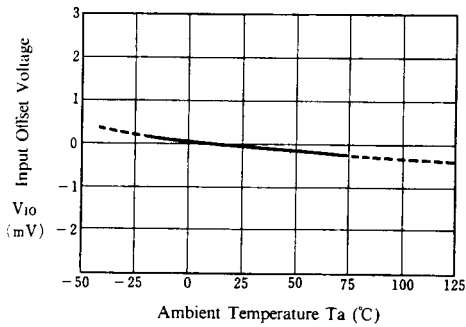

SUPPLY CURRENT vs. TEMPERATURE
($V^+/V^- = \pm 15V$)

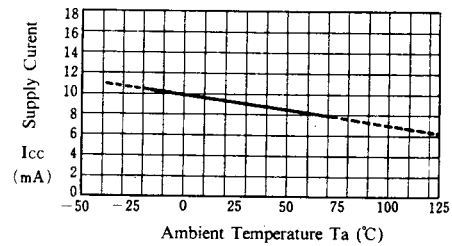

EQUIVALENT INPUT NOISE VOLTAGE vs. FREQUENCY
($V^+/V^- = \pm 15V$, $R_S = 100\Omega$, $A_v = 40dB$, $T_a = 25^\circ C$)

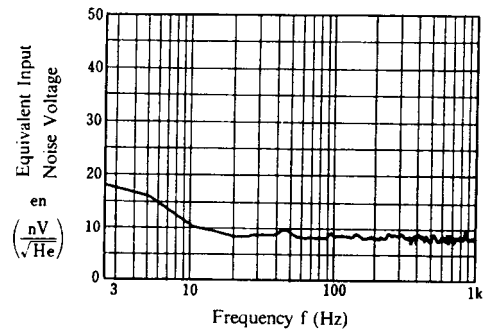

OPERATING CURRENT vs. OPERATING VOLTAGE
($T_a = 25^\circ C$)

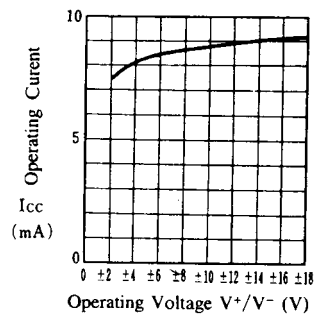

UTC MC4556 LINEAR INTEGRATED CIRCUIT

UTC assumes no responsibility for equipment failures that result from using products at values that exceed, even momentarily, rated values (such as maximum ratings, operating condition ranges, or other parameters) listed in products specifications of any and all UTC products described or contained herein. UTC products are not designed for use in life support appliances, devices or systems where malfunction of these products can be reasonably expected to result in personal injury. Reproduction in whole or in part is prohibited without the prior written consent of the copyright owner. The information presented in this document does not form part of any quotation or contract, is believed to be accurate and reliable and may be changed without notice.