

DS90LV110AT

1 to 10 LVDS Data/Clock Distributor with Failsafe

General Description

DS90LV110A is a 1 to 10 data/clock distributor utilizing LVDS (Low Voltage Differential Signaling) technology for low power, high speed operation. Data paths are fully differential from input to output for low noise generation and low pulse width distortion. The design allows connection of 1 input to all 10 outputs. LVDS I/O enable high speed data transmission for point-to-point interconnects. This device can be used as a high speed differential 1 to 10 signal distribution / fanout replacing multi-drop bus applications for higher speed links with improved signal quality. It can also be used for clock distribution up to 200MHz.

The DS90LV110A accepts LVDS signal levels, LVPECL levels directly or PECL with attenuation networks.

The LVDS outputs can be put into TRI-STATE by use of the enable pin.

For more details, please refer to the Application Information section of this datasheet.

Features

- Low jitter 400 Mbps fully differential data path
- 145 ps (typ) of pk-pk jitter with PRBS = $2^{23}-1$ data pattern at 400 Mbps
- Single +3.3 V Supply
- Balanced output impedance
- Output channel-to-channel skew is 35ps (typ)
- Differential output voltage (V_{OD}) is 320mV (typ) with 100Ω termination load.
- LVDS receiver inputs accept LVPECL signals
- LVDS input failsafe
- Fast propagation delay of 2.8 ns (typ)
- Receiver open, shorted, and terminated input failsafe
- 28 lead TSSOP package
- Conforms to ANSI/TIA/EIA-644 LVDS standard

Connection Diagram

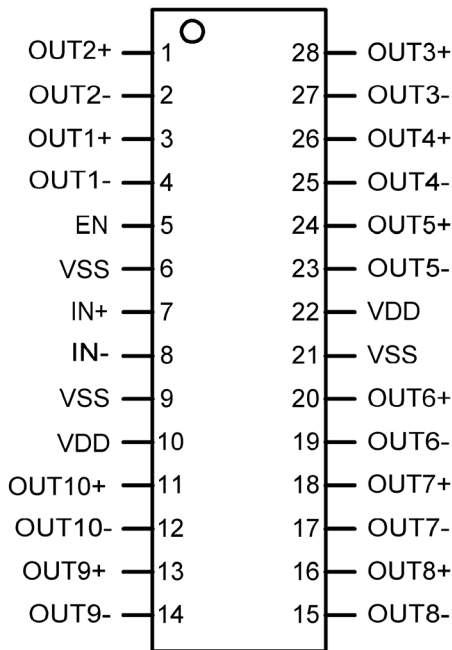

Order Number DS90LV110ATMT
See NS Package Number MTC28

20098205

Block Diagram

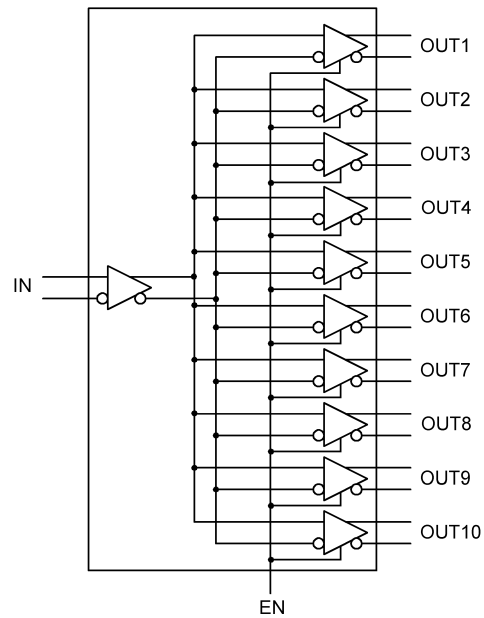

20098201

Absolute Maximum Ratings (Note 1)

If Military/Aerospace specified devices are required, please contact the National Semiconductor Sales Office/Distributors for availability and specifications.

Supply Voltage ($V_{DD}-V_{SS}$)	-0.3V to +4V
LVC MOS/LVTTL Input Voltage (EN)	-0.3V to ($V_{CC} + 0.3V$)
LVDS Receiver Input Voltage (IN+, IN-)	-0.3V to +4V
LVDS Driver Output Voltage (OUT+, OUT-)	-0.3V to +4V
Junction Temperature	+150°C
Storage Temperature Range	-65°C to +150°C
Lead Temperature (Soldering, 4 sec.)	+260°C
Maximum Package Power Dissipation at 25°C	
28L TSSOP	1.209 W

Package Derating

28L TSSOP	9.67 mW/°C above +25°C
θ_{JA}	
28L TSSOP	103.4 °C/Watt

ESD Rating:

(HBM, 1.5k Ω , 100pF)	> 4 kV
(EIAJ, 0 Ω , 200pF)	> 250 V

Recommended Operating Conditions

	Min	Typ	Max	Units
Supply Voltage ($V_{DD} - V_{SS}$)	3.0	3.3	3.6	V
Receiver Input Voltage	0		V_{DD}	V
Operating Free Air Temperature	-40	+25	+85	°C

Electrical Characteristics

Over recommended operating supply and temperature ranges unless otherwise specified

Symbol	Parameter	Conditions	Min	Typ	Max	Units
LVC MOS/LVTTL DC SPECIFICATIONS (EN)						
V_{IH}	High Level Input Voltage		2.0		V_{DD}	V
V_{IL}	Low Level Input Voltage		V_{SS}		0.8	V
I_{IH}	High Level Input Current	$V_{IN} = 3.6V$ or $2.0V$; $V_{DD} = 3.6V$		± 7	± 20	μA
I_{IL}	Low Level Input Current	$V_{IN} = 0V$ or $0.8V$; $V_{DD} = 3.6V$		± 7	± 20	μA
V_{CL}	Input Clamp Voltage	$I_{CL} = -18$ mA		-0.8	-1.5	V
LVDS OUTPUT DC SPECIFICATIONS (OUT1, OUT2, OUT3, OUT4, OUT5, OUT6, OUT7, OUT8, OUT9, OUT10)						
V_{OD}	Differential Output Voltage	$R_L = 100\Omega$	250	320	450	mV
		$R_L = 100\Omega$, $V_{DD} = 3.3V$, $T_A = 25^\circ C$	260	320	425	mV
ΔV_{OD}	Change in V_{OD} between Complimentary Output States				35	ImVl
V_{OS}	Offset Voltage (Note 3)		1.125	1.25	1.375	V
ΔV_{OS}	Change in V_{OS} between Complimentary Output States				35	ImVl
I_{OZ}	Output TRI-STATE Current	EN = 0V, $V_{OUT} = V_{DD}$ or GND		± 1	± 10	μA
I_{OFF}	Power-Off Leakage Current	$V_{DD} = 0V$; $V_{OUT} = 3.6V$ or GND		± 1	± 10	μA
I_{SA}, I_{SB}	Output Short Circuit Current	V_{OUT+} OR $V_{OUT-} = 0V$ or V_{DD}		12	24	ImAl
I_{SAB}	Both Outputs Shorted (Note 4)	$V_{OUT+} = V_{OUT-}$		6	12	ImAl
LVDS RECEIVER DC SPECIFICATIONS (IN)						
V_{TH}	Differential Input High Threshold	$V_{CM} = +0.05V$ or $+1.2V$ or $+3.25V$,		0	+100	mV
V_{TL}	Differential Input Low Threshold	$V_{DD} = 3.3V$	-100	0		mV
V_{CMR}	Common Mode Voltage Range	$V_{ID} = 100mV$, $V_{DD} = 3.3V$	0.05		3.25	V
I_{IN}	Input Current	$V_{IN} = +3.0V$, $V_{DD} = 3.6V$ or $0V$		± 1	± 10	μA
		$V_{IN} = 0V$, $V_{DD} = 3.6V$ or $0V$		± 1	± 10	μA

Electrical Characteristics (Continued)

Over recommended operating supply and temperature ranges unless otherwise specified

Symbol	Parameter	Conditions	Min	Typ	Max	Units
SUPPLY CURRENT						
I _{CCD}	Total Supply Current	R _L = 100Ω, C _L = 5 pF, 200 MHz, EN = High		125	160	mA
		No Load, 200 MHz, EN = High		80	125	mA
I _{CCZ}	TRI-STATE Supply Current	EN = Low		15	29	mA

Note 1: "Absolute Maximum Ratings" are those beyond which the safety of the device cannot be guaranteed. They are not meant to imply that the device should be operated at these limits. The table of "Electrical Characteristics" provides conditions for actual device operation.

Note 2: All typical are given for V_{CC} = +3.3V and T_A = +25°C, unless otherwise stated.

Note 3: V_{OS} is defined as (V_{OH} + V_{OL}) / 2.

Note 4: Only one output can be shorted at a time. Don't exceed the package absolute maximum rating.

AC Electrical Characteristics

Over recommended operating supply and temperature ranges unless otherwise specified.

Symbol	Parameter	Conditions	Min	Typ	Max	Units
T _{LHT}	Output Low-to-High Transition Time, 20% to 80%, <i>Figure 4</i> (Note 5)			390	550	ps
T _{HLT}	Output High-to-Low Transition Time, 80% to 20%, <i>Figure 4</i> (Note 5)			390	550	ps
T _{DJ}	LVDS Data Jitter, Deterministic (Peak-to-Peak)(Note 6)	V _{ID} = 300mV; PRBS=2 ²³ -1 data; V _{CM} = 1.2V at 400 Mbps (NRZ)		145		ps
T _{RJ}	LVDS Clock Jitter, Random (Note 6)	V _{ID} = 300mV; V _{CM} = 1.2V at 200 MHz clock		2.8		ps
T _{PLHD}	Propagation Low to High Delay, <i>Figure 5</i>		2.2	2.8	3.6	ns
T _{PHLD}	Propagation High to Low Delay, <i>Figure 5</i>		2.2	2.8	3.9	ns
T _{SKEW}	Pulse Skew T _{PLHD} - T _{PHLD} (Note 5)			20	340	ps
T _{CCS}	Output Channel-to-Channel Skew, <i>Figure 6</i> (Note 5)			35	91	ps
T _{PHZ}	Disable Time (Active to TRI-STATE) High to Z, <i>Figure 1</i>			3.0	6.0	ns
T _{PLZ}	Disable Time (Active to TRI-STATE) Low to Z, <i>Figure 1</i>			1.8	6.0	ns
T _{PZH}	Enable Time (TRI-STATE to Active) Z to High, <i>Figure 1</i>			10.0	23.0	ns
T _{PZL}	Enable Time (TRI-STATE to Active) Z to Low, <i>Figure 1</i>			7.0	23.0	ns

Note 5: The parameters are guaranteed by design. The limits are based on statistical analysis of the device performance over PVT (process, voltage and temperature) range.

Note 6: The measurement used the following equipment and test setup: HP8133A pattern/pulse generator, 5 feet of RG-142 cable with DUT test board and HP83480A (digital scope mainframe) with HP83484A (50GHz scope module). The HP8133A with the RG-142 cable exhibit a T_{DJ} = 26ps and T_{RJ} = 1.3 ps

AC Timing Diagrams

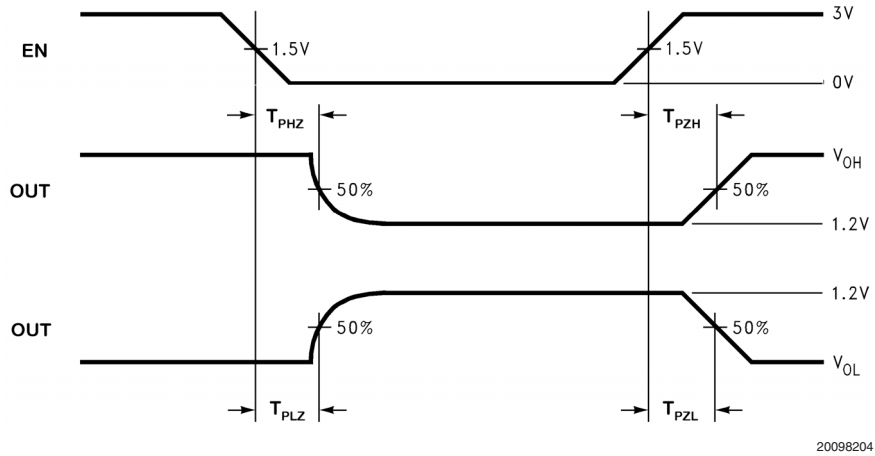

20098204

FIGURE 1. Output active to TRI-STATE and TRI-STATE to active output time

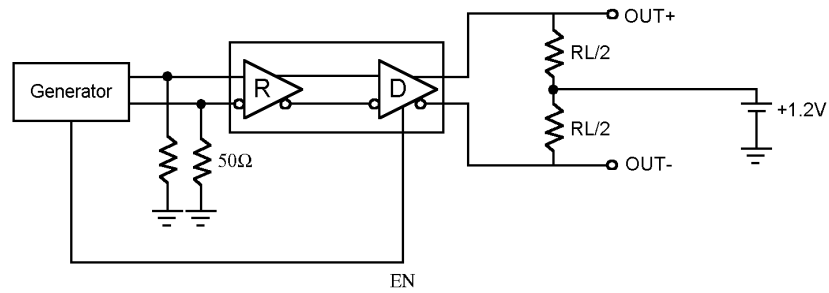

20098215

FIGURE 2. LVDS Driver TRI-STATE Circuit

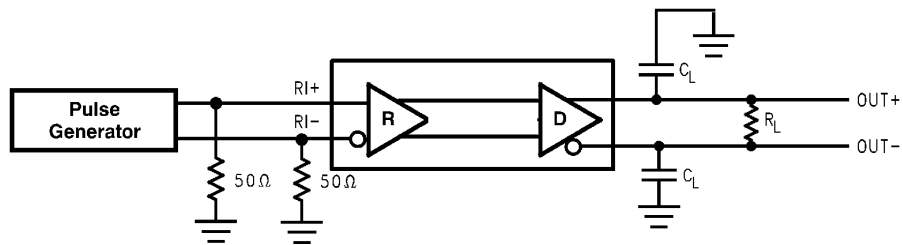

20098206

FIGURE 3. LVDS Output Load

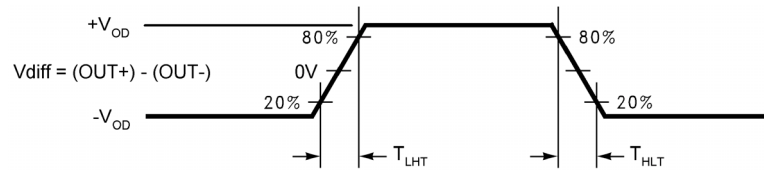

20098209

FIGURE 4. LVDS Output Transition Time

AC Timing Diagrams (Continued)

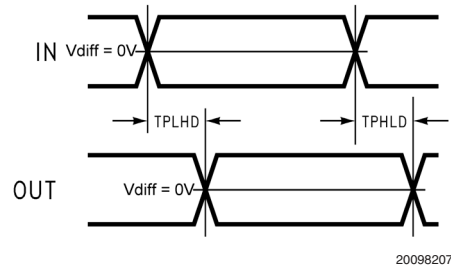

FIGURE 5. Propagation Delay Low-to-High and High-to-Low

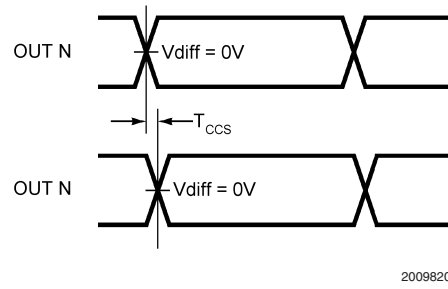

FIGURE 6. Output 1 to 10 Channel-to-Channel Skew

DS90LV110A Pin Descriptions

Pin Name	# of Pin	Input/Output	Description
IN+	1	I	Non-inverting LVDS input
IN -	1	I	Inverting LVDS input
OUT+	10	O	Non-inverting LVDS Output
OUT -	10	O	Inverting LVDS Output
EN	1	I	This pin has an internal pull-down when left open. A logic low on the Enable puts all the LVDS outputs into TRI-STATE and reduces the supply current.
V _{SS}	3	P	Ground (all ground pins must be tied to the same supply)
V _{DD}	2	P	Power Supply (all power pins must be tied to the same supply)

Application Information

INPUT FAIL-SAFE

The receiver inputs of the DS90LV110A have internal fail-safe biasing for short, open, and terminated input conditions.

LVDS INPUTS TERMINATION

The LVDS Receiver input must have a 100Ω termination resistor placed as close as possible across the input pins.

UNUSED CONTROL INPUTS

The EN control input pin has internal pull down device. If left open, the 10 outputs will default to TRI-STATE.

EXPANDING THE NUMBER OF OUTPUT PORTS

To expand the number of output ports, more than one DS90LV110A can be used. Total propagation delay through the devices should be considered to determine the maximum expansion. Adding more devices will increase the output jitter due to each pass.

PCB LAYOUT AND POWER SYSTEM BYPASS

Circuit board layout and stack-up for the DS90LV110A should be designed to provide noise-free power to the device. Good layout practice also will separate high frequency or high level inputs and outputs to minimize unwanted stray noise pickup, feedback and interference. Power system performance may be greatly improved by using thin dielectrics (4 to 10 mils) for power/ground sandwiches. This increases the intrinsic capacitance of the PCB power system which improves power supply filtering, especially at high frequen-

cies, and makes the value and placement of external bypass capacitors less critical. External bypass capacitors should include both RF ceramic and tantalum electrolytic types. RF capacitors may use values in the range 0.01 μF to 0.1 μF. Tantalum capacitors may be in the range 2.2 μF to 10 μF. Voltage rating for tantalum capacitors should be at least 5X the power supply voltage being used. It is recommended practice to use two vias at each power pin of the DS90LV110A as well as all RF bypass capacitor terminals. Dual vias reduce the interconnect inductance by up to half, thereby reducing interconnect inductance and extending the effective frequency range of the bypass components.

The outer layers of the PCB may be flooded with additional ground plane. These planes will improve shielding and isolation as well as increase the intrinsic capacitance of the power supply plane system. Naturally, to be effective, these planes must be tied to the ground supply plane at frequent intervals with vias. Frequent via placement also improves signal integrity on signal transmission lines by providing short paths for image currents which reduces signal distortion. The planes should be pulled back from all transmission lines and component mounting pads a distance equal to the width of the widest transmission line or the thickness of the dielectric separating the transmission line from the internal power or ground plane(s) whichever is greater. Doing so minimizes effects on transmission line impedances and reduces unwanted parasitic capacitances at component mounting pads.

There are more common practices which should be followed when designing PCBs for LVDS signaling. Please see Application Note: AN-1108 for additional information.

Multi-drop Applications

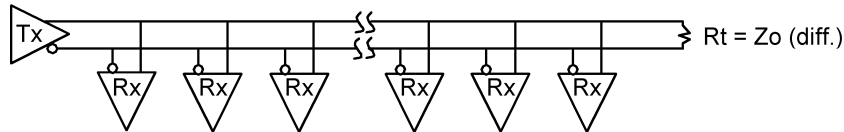

20098202

Point-to-Point Distribution Applications

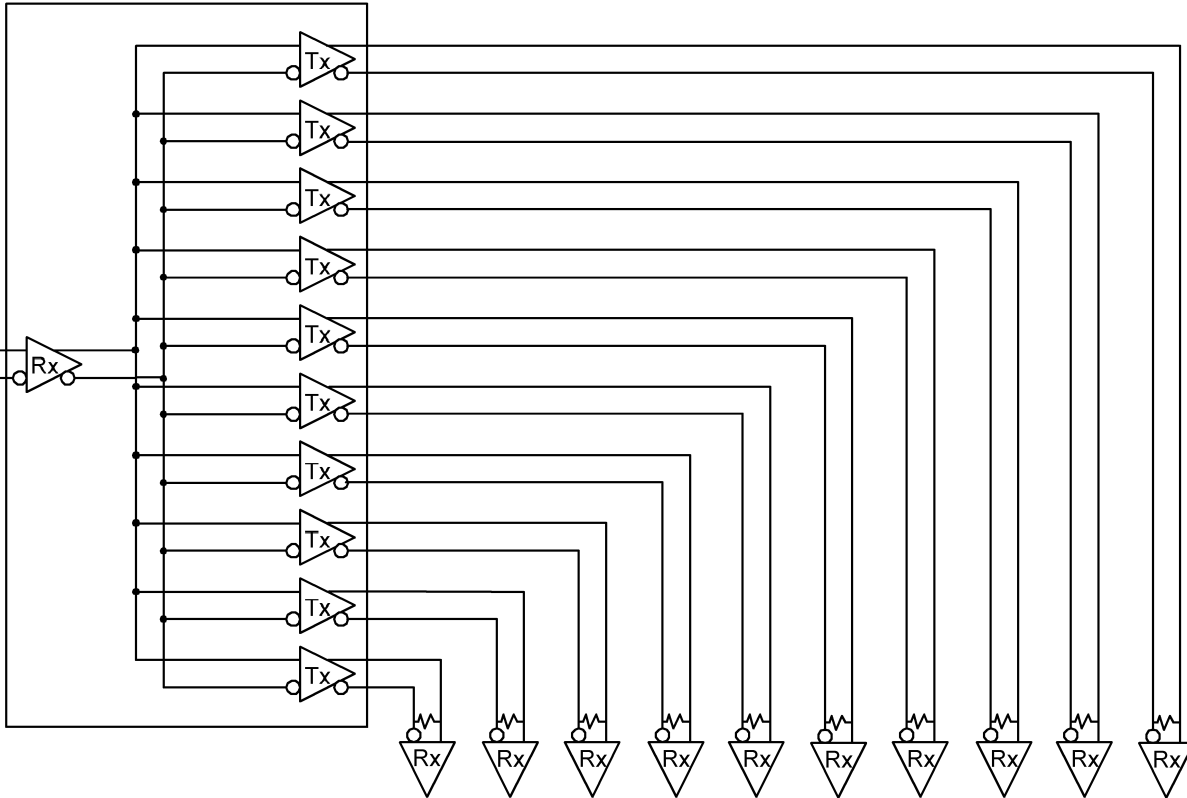

20098203

For applications operating at data rate greater than 400Mbps, a point-to-point distribution application should be used. This improves signal quality compared to multi-drop applications due to no stub PCB trace loading. The only load is a receiver at the far end of the transmission line. Point-to-point distribution applications will have a wider LVDS bus lines, but data rate can increase well above 400Mbps due to the improved signal quality.

Typical Performance Characteristics

Output Voltage (V_{OD}) vs. Resistive Load (R_L)

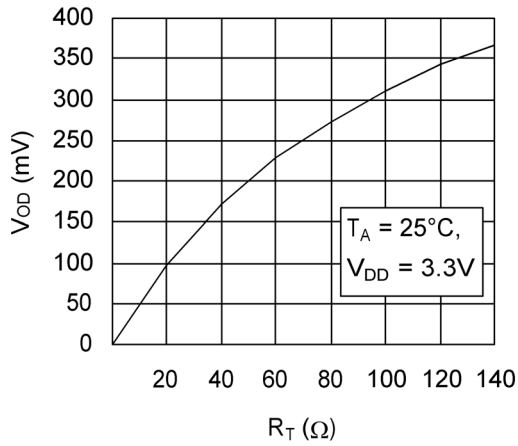

20098211

Peak-to-Peak Output Jitter at $V_{CM} = +0.4V$ vs. VID

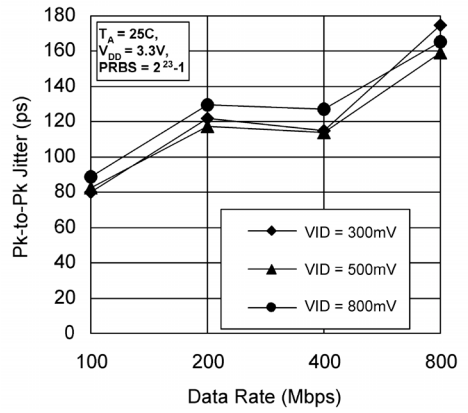

20098212

Peak-to-Peak Output Jitter at $V_{CM} = +1.2V$ vs. VID

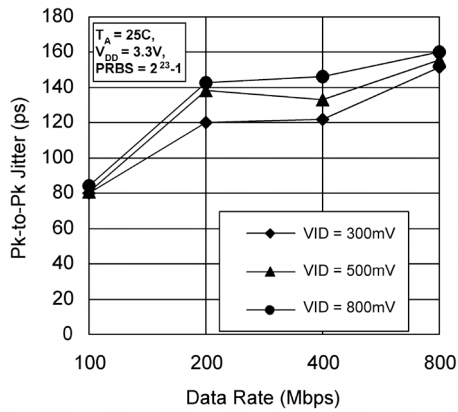

20098213

Peak-to-Peak Output Jitter at $V_{CM} = +2.9V$ vs. VID

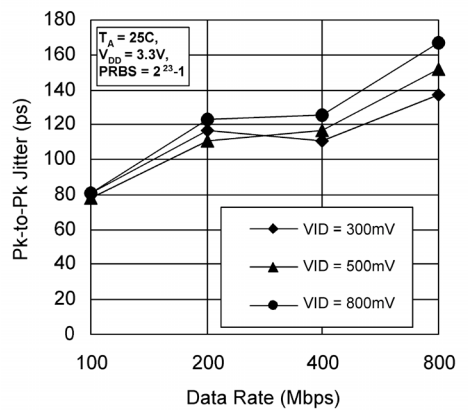

20098214

Physical Dimensions inches (millimeters) unless otherwise noted

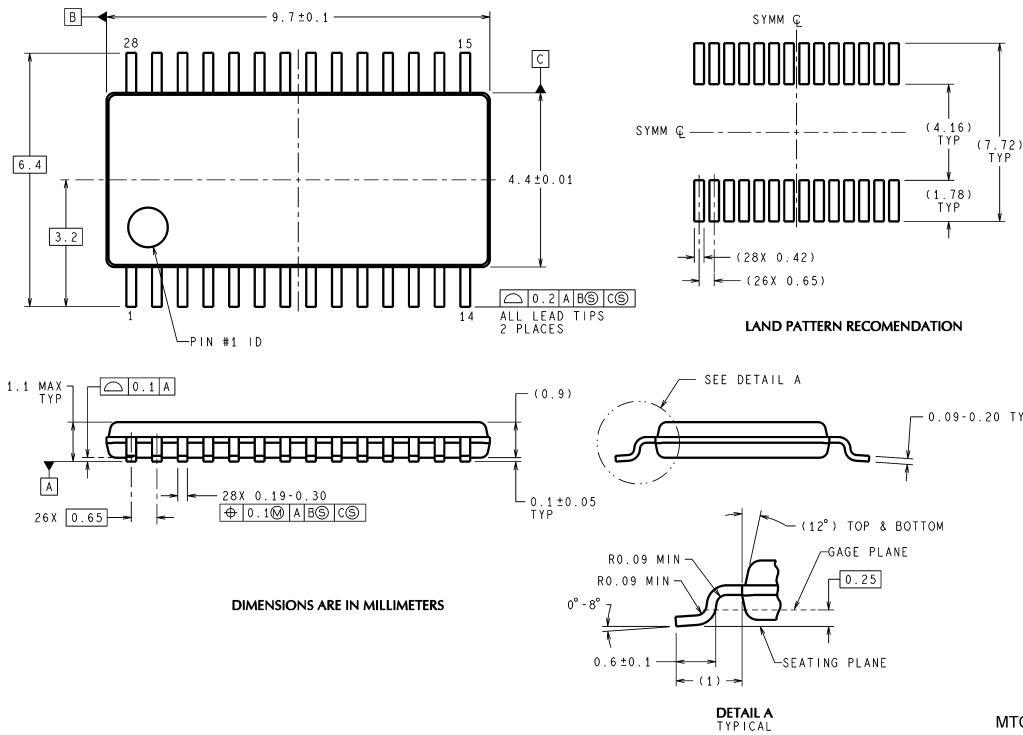

NS Package Number MTC28
Order Number DS90LV110ATMT (Rail quantity of 48)
DS90LV110ATMTX (2500 piece Tape and Reel)

National does not assume any responsibility for use of any circuitry described, no circuit patent licenses are implied and National reserves the right at any time without notice to change said circuitry and specifications.

For the most current product information visit us at www.national.com.

LIFE SUPPORT POLICY

NATIONAL'S PRODUCTS ARE NOT AUTHORIZED FOR USE AS CRITICAL COMPONENTS IN LIFE SUPPORT DEVICES OR SYSTEMS WITHOUT THE EXPRESS WRITTEN APPROVAL OF THE PRESIDENT AND GENERAL COUNSEL OF NATIONAL SEMICONDUCTOR CORPORATION. As used herein:

1. Life support devices or systems are devices or systems which, (a) are intended for surgical implant into the body, or (b) support or sustain life, and whose failure to perform when properly used in accordance with instructions for use provided in the labeling, can be reasonably expected to result in a significant injury to the user.
2. A critical component is any component of a life support device or system whose failure to perform can be reasonably expected to cause the failure of the life support device or system, or to affect its safety or effectiveness.

BANNED SUBSTANCE COMPLIANCE

National Semiconductor certifies that the products and packing materials meet the provisions of the Customer Products Stewardship Specification (CSP-9-111C2) and the Banned Substances and Materials of Interest Specification (CSP-9-111S2) and contain no "Banned Substances" as defined in CSP-9-111S2.



National Semiconductor
Americas Customer Support Center
 Email: new.feedback@nsc.com
 Tel: 1-800-272-9959

National Semiconductor
Europe Customer Support Center
 Fax: +49 (0) 180-530 85 86
 Email: europe.support@nsc.com
 Deutsch Tel: +49 (0) 69 9508 6208
 English Tel: +44 (0) 870 24 0 2171
 Français Tel: +33 (0) 1 41 91 8790

National Semiconductor
Asia Pacific Customer Support Center
 Email: ap.support@nsc.com

National Semiconductor
Japan Customer Support Center
 Fax: 81-3-5639-7507
 Email: jpn.feedback@nsc.com
 Tel: 81-3-5639-7560