



# LA1805

## AM/FM-IF/MPX Tuner System for Radio-Cassette Recorders, Music Centers

### Overview

The LA1805 is a characteristics-improved version of the LA1810, with the same pin assignment and package as those of the LA1810. Improvements are made on the following point :

- Separation (35dB→48dB) and its dependence on free-running frequency (Sep –  $f_F$  Characteristic on page 4).
- FM main distortion (0.8%→0.45%).
- AM detection output (approximately 5dB increased).

The constants on five external parts are changed as shown on page 10.

### Functions

- FM-IF : IF amp, quadrature detector, soft muting, tuning indicator.
- MPX : PLL stereo decoder, stereo indicator, forced monaural, VCO stop.
- AM : RF amp, MIX, OSC (with ALC), IF amp, detector, AGC, tuning indicator.

### Features

- FM/AM/MPX functions contained on a single chip.
- Minimum number of external parts required.
- On-chip FM muting function.
- High sensitivity.
- Less carrier leak of MPX.

### Specifications

**Maximum Ratings** at  $T_a=25^\circ\text{C}$ , See specified Test Circuit.

Parameter	Symbol	Conditions	Ratings	Unit
Maximum supply voltage	$V_{CC}$ max	Pins 3, 7, 8, 11, 20, 21	9	V
Maximum supply current	$I_{CC}$ max	Pins 3+20+21	50	mA
Flow-in current (Indicator drive current)	$I_{LED}$	Pins 7, 8	20	mA
Flow-out current	$I_{23}$	Pin 23	0.1	mA
Allowable power dissipation	$P_d$ max	$T_a \leq 70^\circ\text{C}$	500	mW
Operating temperature	$T_{opr}$		-20 to +70	$^\circ\text{C}$
Storage temperature	$T_{stg}$		-40 to +125	$^\circ\text{C}$

### Package Dimensions

unit : mm

#### 3067-DIP24S

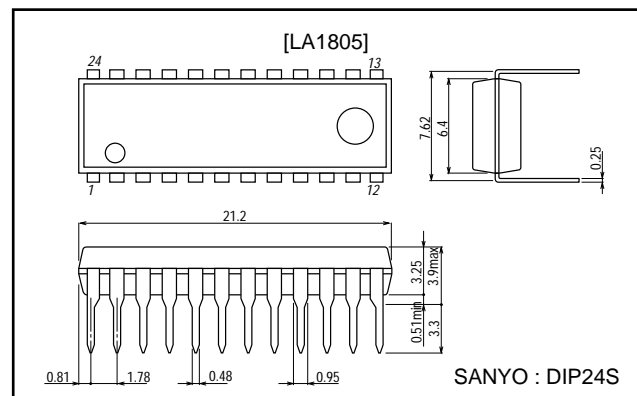

# LA1805

## Operating Conditions at $T_a=25^\circ\text{C}$

Parameter	Symbol	Conditions	Ratings	Unit
Recommended operating voltage	$V_{CC}$		4.5	V
Operating voltage range	$V_{CC\ op}$		3.0 to 8.0	V

Note : The FM output level forms an N curve (LA1805) and an S curve (LA1806).

LA1805 : N curve (for US band)

LA1806 : S curve (for Japanese band). Your desired output level can be set by varying the output resistance.

## Operating Characteristics at $T_a=25^\circ\text{C}$ , $V_{CC}=4.5\text{V}$ , See Test Circuit

Parameter	Symbol	Conditions	Ratings			Unit
			min	typ	max	
[FM characteristics (Mono) : $f_c=10.7\text{MHz}$ , $f_m=1\text{kHz}$ ]						
Quiescent current	$I_{cco}$	No input		13	20	mA
-3dB sensitivity	-3dBLS.	Referenced to $V_{IN}=100\text{dB}\mu$ , 100%, down 3dB		28	35	$\text{dB}\mu$
Demodulation output	$V_O$	$V_{IN}=100\text{dB}\mu$ , 100% mod.	140	205	280	mV
Channel balance	C.B.	$V_{IN}=100\text{dB}\mu$ , 100% mod.	0	0	1.5	dB
Total harmonic distortion	THD	$V_{IN}=100\text{dB}\mu$ , 100% mod.		0.45	1.2	%
Signal to noise ratio	S/N	$V_{IN}=100\text{dB}\mu$ , 100% mod.	70	80		dB
LED ON sensitivity	$V_{LED}$	$I_L=1\text{mA}$	23	33	43	$\text{dB}\mu$
[FM characteristics (Stereo) : $f_c=10.7\text{MHz}$ , $f_m=1\text{kHz}$ , L+R=90%, pilot=10%, $V_{IN}=100\text{dB}\mu$ ]						
Separation	Sep		32	48		dB
Stereo distortion	THD (Main)			0.45	1.2	%
LED ON level	$V_{LED-on}$		2.4	3.9	5.4	%
LED OFF level	$V_{LED-off}$			2.7		%
[AM characteristics : $f_c=1000\text{kHz}$ , $f_m=1\text{kHz}$ ]						
Quiescent current	$I_{cco}$	No input		9.5	14.5	mA
Demodulation output	$V_{O1}$	$V_{IN}=23\text{dB}\mu$ , 30% mod.	27	50	90	mV
	$V_{O2}$	$V_{IN}=80\text{dB}\mu$ , 30% mod.	70	113	173	mV
Signal to noise ratio	S/N1	$V_{IN}=23\text{dB}\mu$ , 30% mod.	17	21		dB
	S/N2	$V_{IN}=80\text{dB}\mu$ , 30% mod.	50	55		dB
Total harmonic distortion	THD1	$V_{IN}=80\text{dB}\mu$ , 30% mod.		0.45	1.2	%
	THD2	$V_{IN}=100\text{dB}\mu$ , 30% mod.		0.6	1.5	%
LED on sensitivity	$V_{LED}$	$I_L=1\text{mA}$	16	24	32	$\text{dB}\mu$

Note : Be fully careful of dielectric breakdown.

## Equivalent Circuit Block Diagram

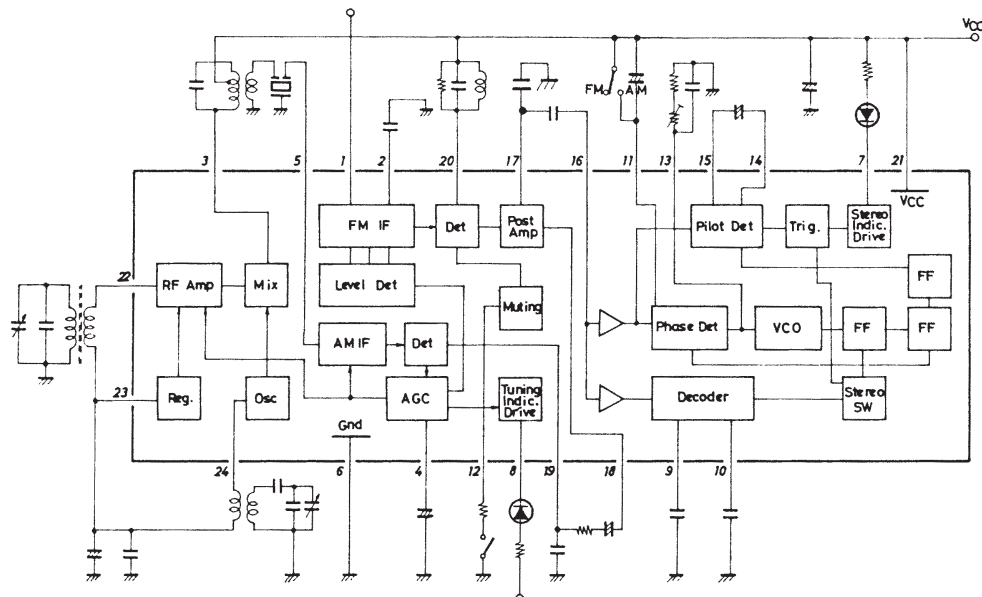

Test Circuit

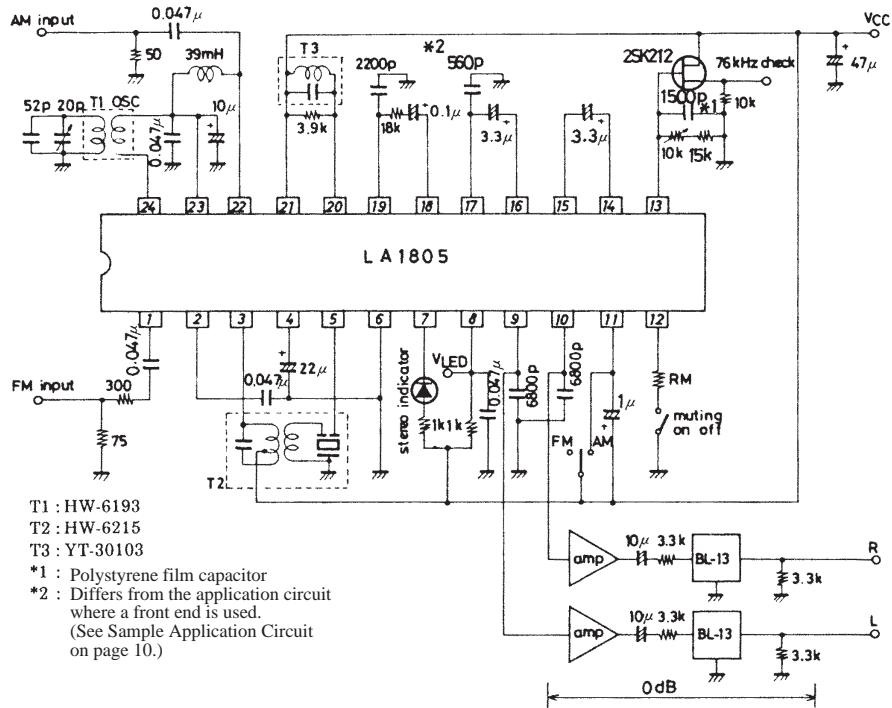

Unit (resistance : Ω, capacitance : F)

How to use the LA1805

1. Forced monaural mode.

Figures 1 and 2 show how to cause the forced monaural mode to be entered.

- (1) Connect pin 14 to VCC through a resistor of 100kΩ. (Turn ON the SW1 in Figure 1.)
- (2) Connect pin 15 to GND through a resistor of 47kΩ. (Turn ON the SW2 in Figure 2.)

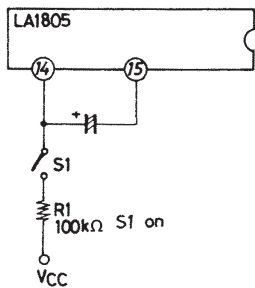

Figure 1 Forced Monaural Mode Setting Method

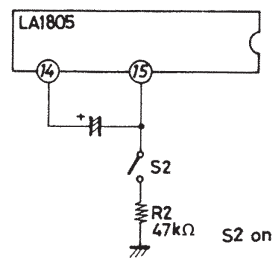

Figure 2 Forced Monaural Mode Setting Method

Either above-mentioned (1) or (2) causes the forced monaural mode to be entered. In this case, the VCO does not stop operating. If the resistance of R1 and R2 are decreased, internal bias will vary when the S1 or S2 is turned ON. This data is shown in Figure 3.

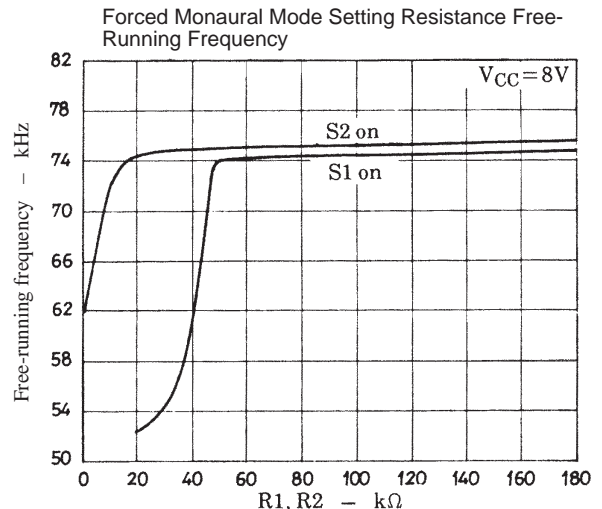

Figure 3

2. VCO Stop

The VCO is so designed as to stop automatically at the AM mode.

(when pin 11 and pin 21 are at the same potential)

There is no pin available for stopping the VCO at the FM mode. However, the method shown right can be used to stop the VCO at the FM mode, causing the forced monaural mode to be entered.

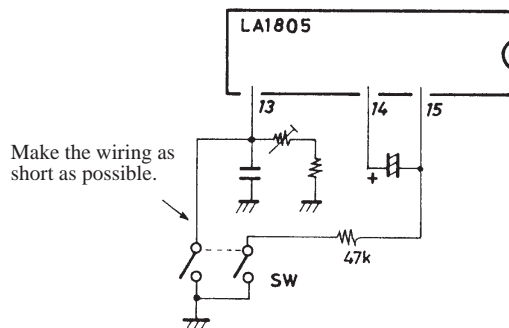

Figure 4

3. Free-running frequency measurement and adjustment

Either of the following two methods is used to measure the free-running frequency.

- (1) Connect pin 13 to a frequency counter through the high input impedance amplifier.
- (2) Connect the connection point of the semifixed resistor connected to pin 13 and the fixed resistor to a frequency counter through the resistor of 240kΩ or greater.

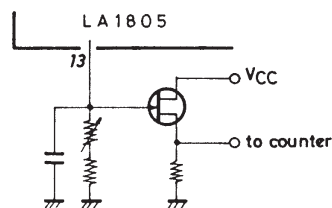

Figure 5

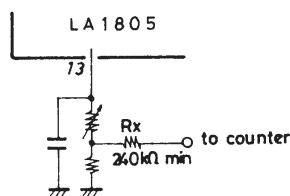

Figure 6

How the error changes with the resistor value is shown in Figure 7.

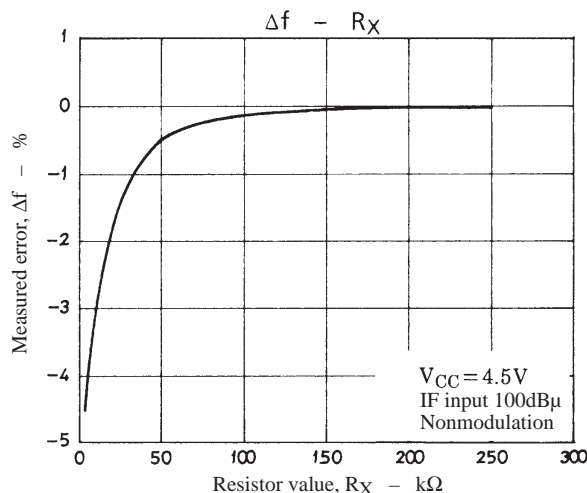

Figure 7

- When setting the free-running frequency, the following must be noted.

Apply a 10.7MHz 100dBμ nonmodulation carrier as IF input signal and set to 76kHz±50Hz with the tuning indicator lighted.

4. Separation setting capacitor  $C_s$

The separation characteristic for the LA1805 alone (IF input) differs from that for the antenna input with a front end. This difference is caused by the characteristics of the front end and ceramic filter. Shown right is how the separation characteristic changes with the separation setting capacitor value when the LA1186N is used as front end. Referring to this separation characteristic, choose the optimum separation for your set model.

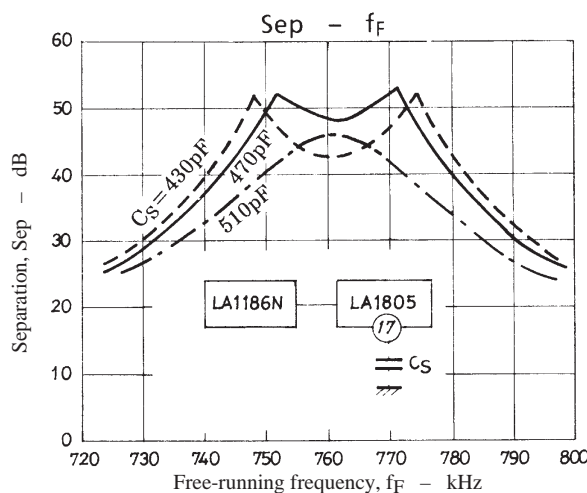

Figure 8

5. FM muting pin

The external resistor connected to pin 12 can be used to vary the muting level (Figure 9). The abnormal sound at the time of side peak reception at the FM mode can be reduced by weak signal muting.

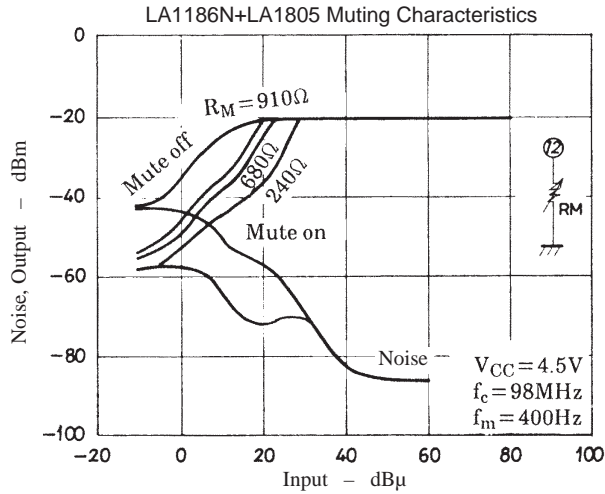

Figure 9

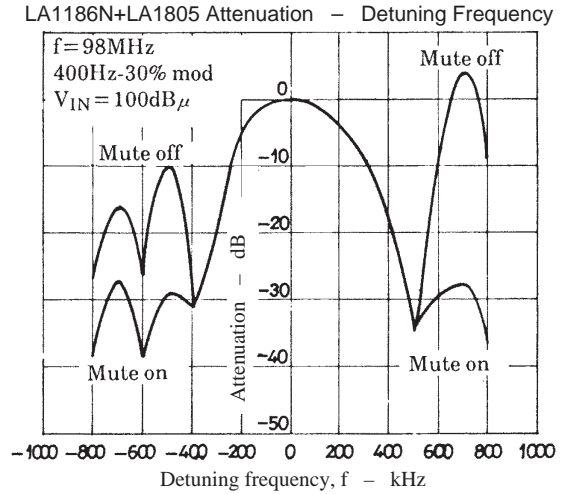

Figure 10

6. The following method can be used to change the LED ON sensitivity at the FM mode (Figure 11). The data on the LED ON sensitivity setting resistance and LED ON sensitivity is shown in Figure 12.

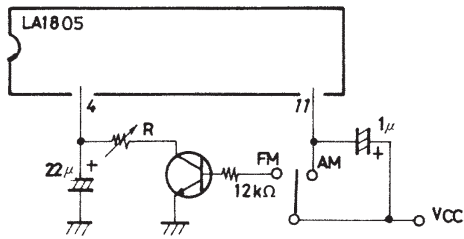

Figure 11 Method to Change the LED ON Sensitivity at the FM Mode

Unit (capacitance : F)

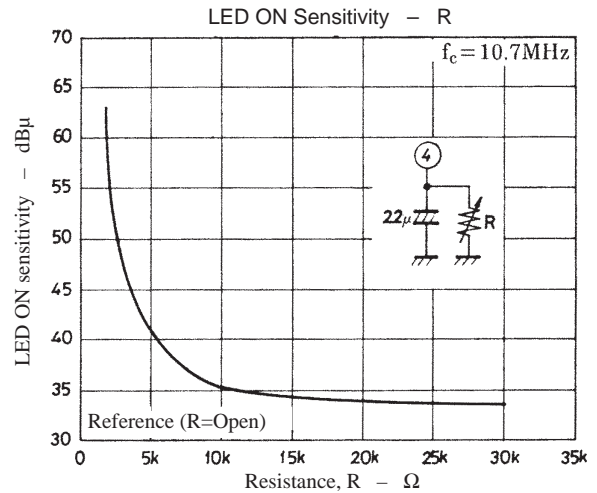

Figure 12

7. AM-FM selection

The FM mode is entered with pin 11 open as shown in Figure 13. When pin 11 and pin 21 are made to be at the same potential in terms of DC, the AM mode is entered. It should be noted that the dynamic range is narrowed whether the potential at pin 11 is lower or higher than that at pin 21.

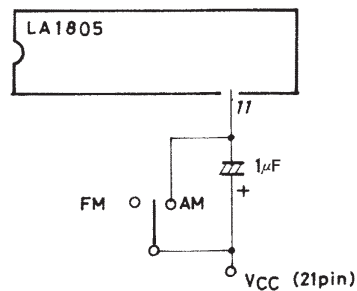
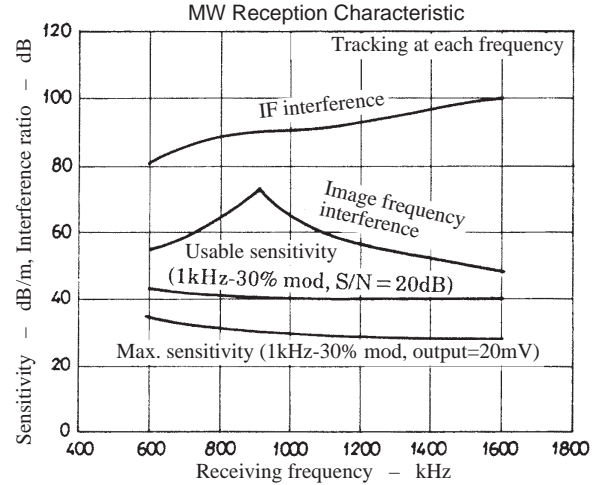
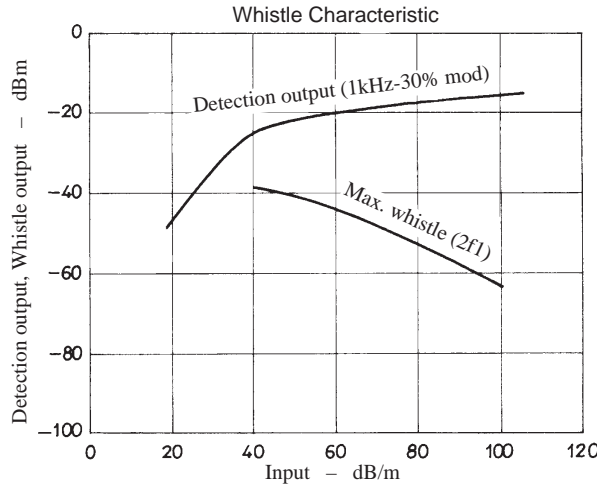
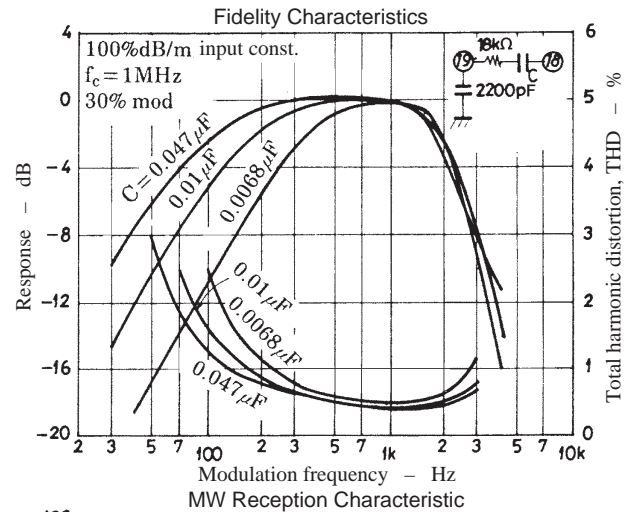
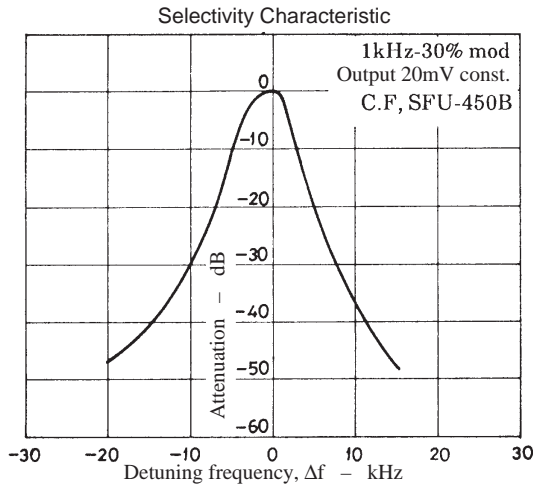
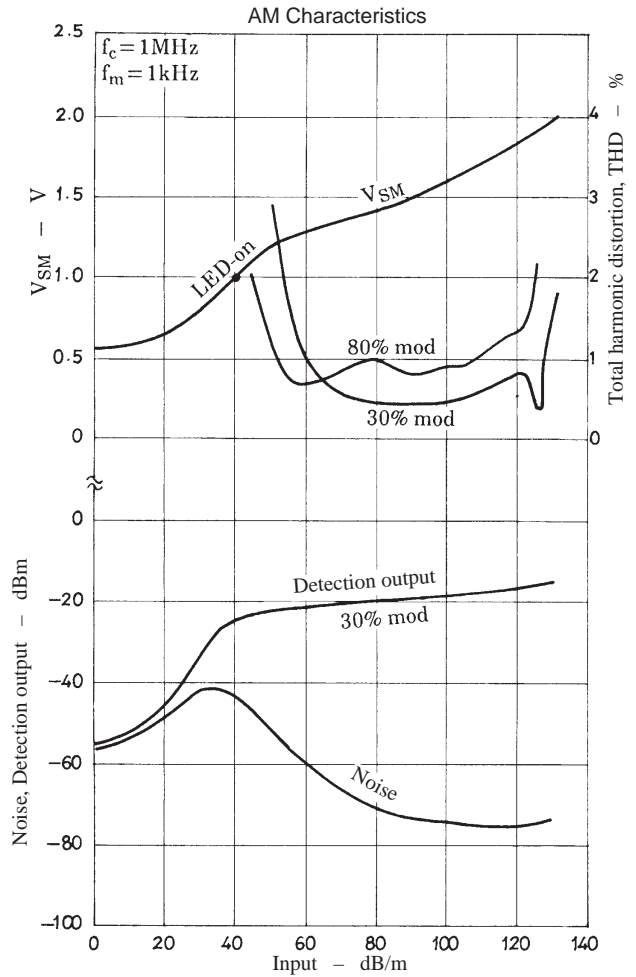
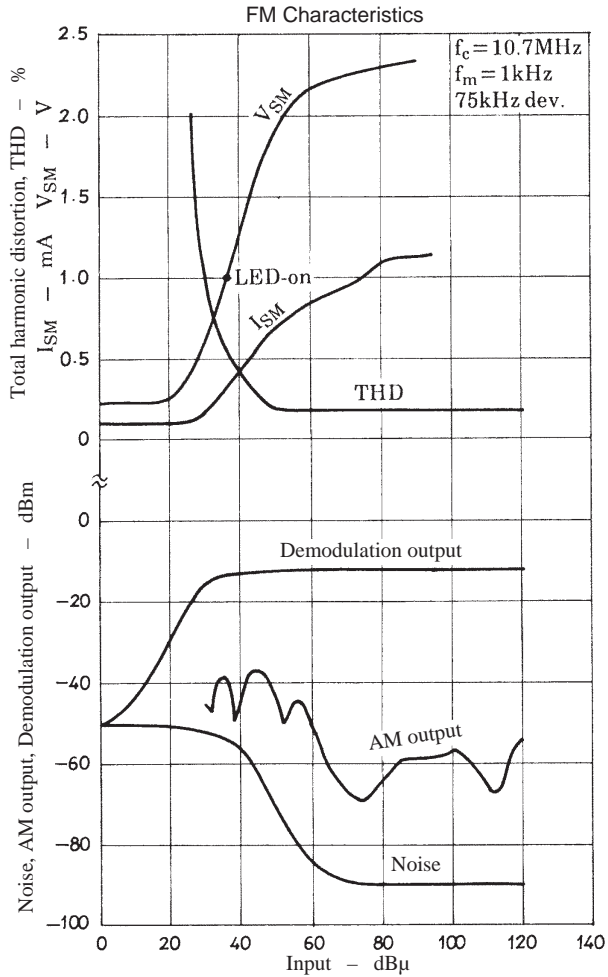
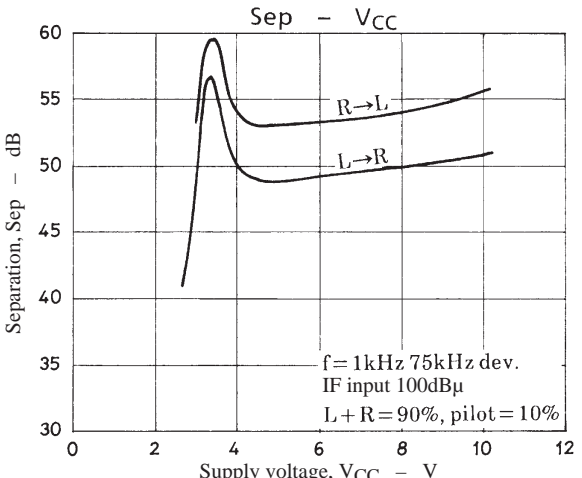
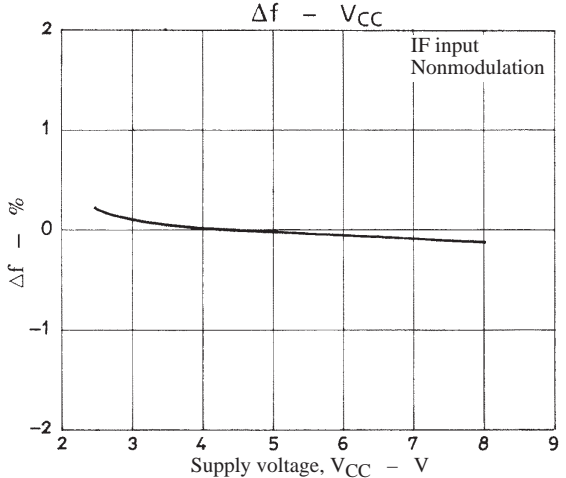
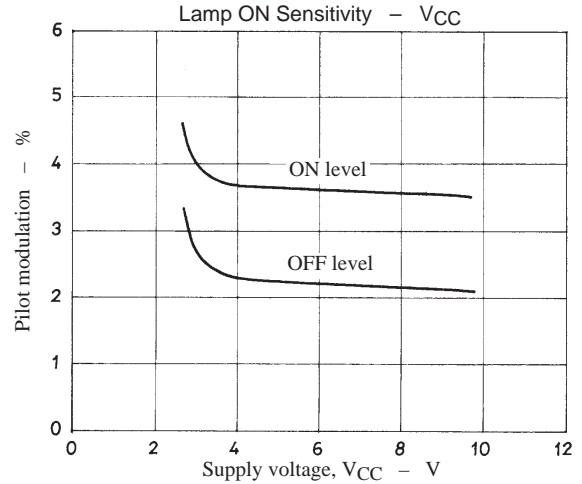
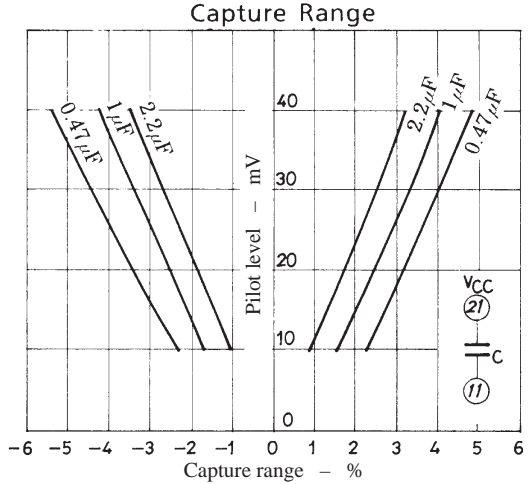
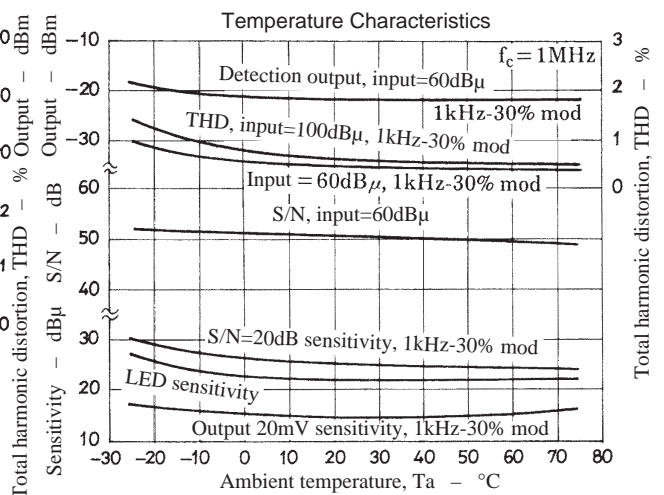
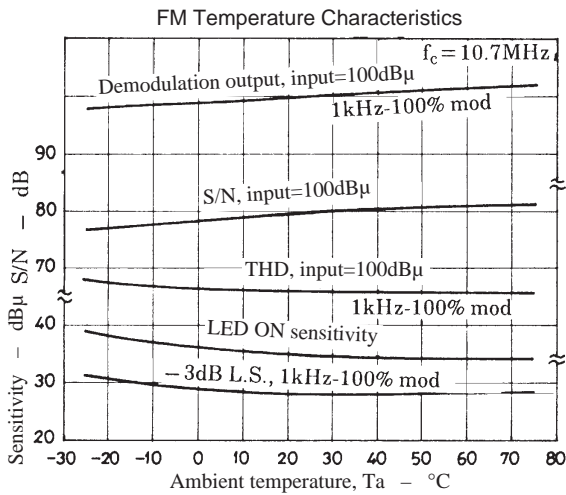
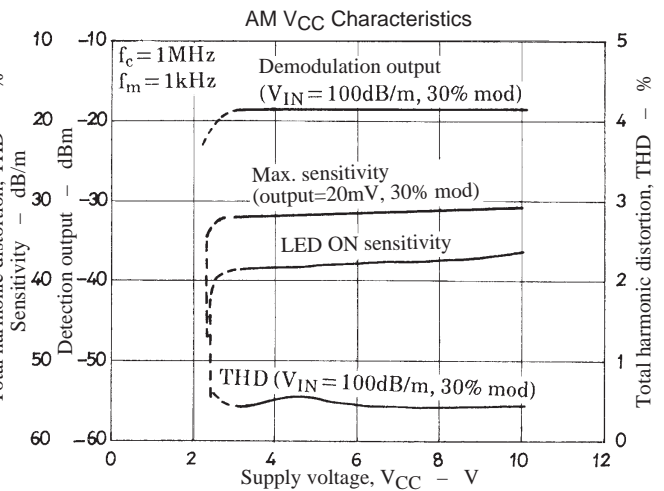
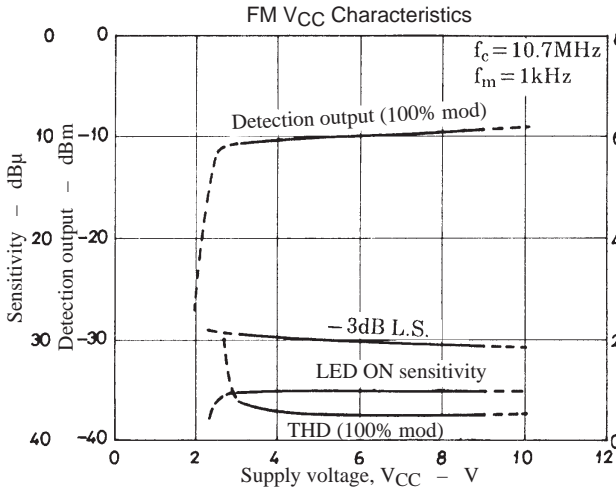
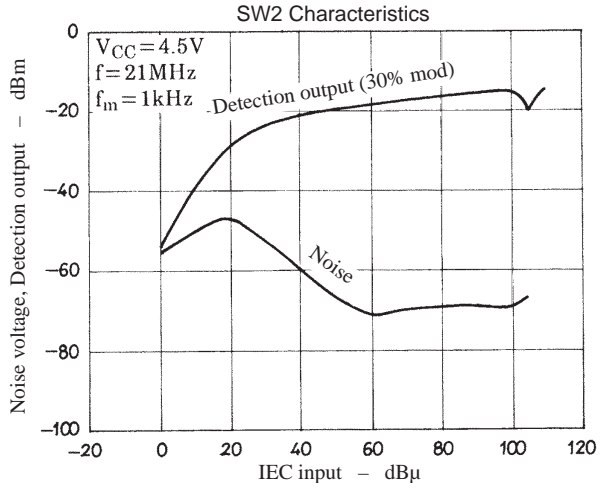
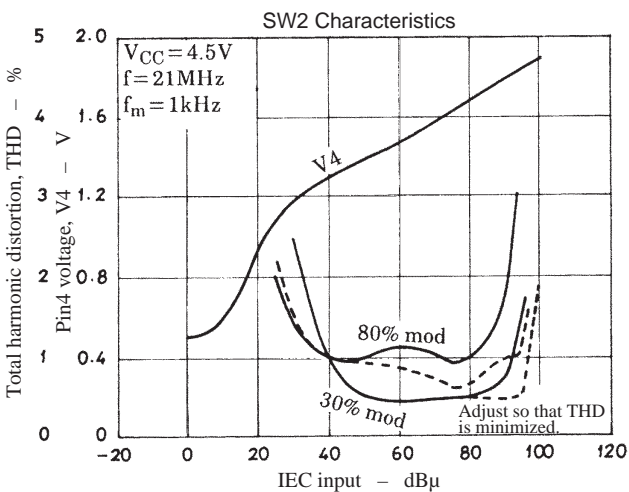
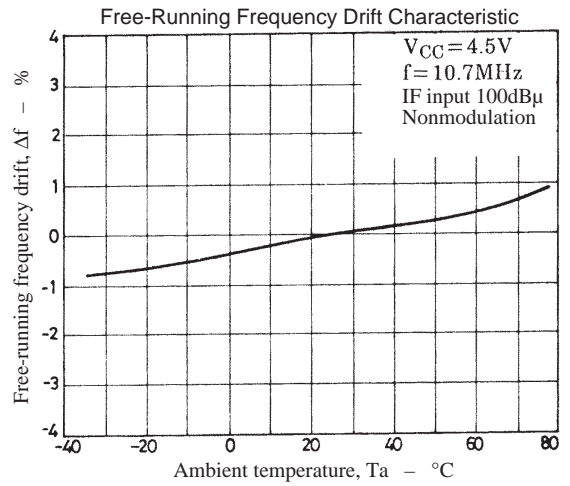
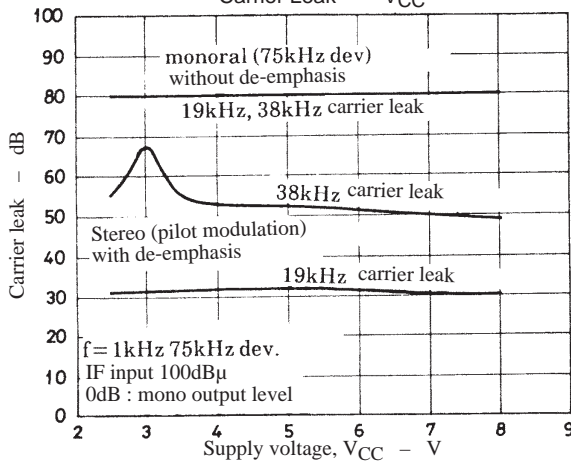
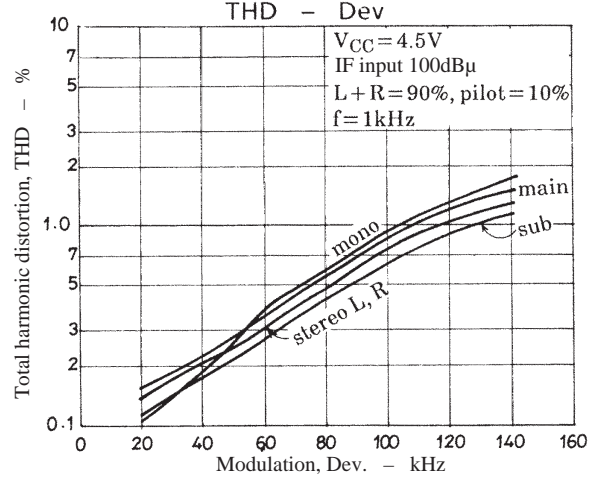
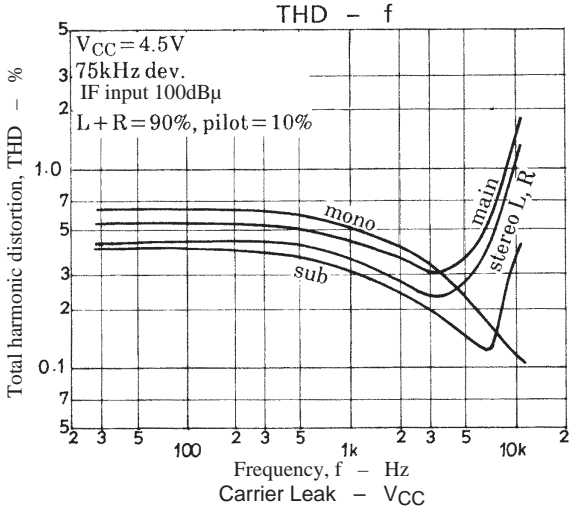
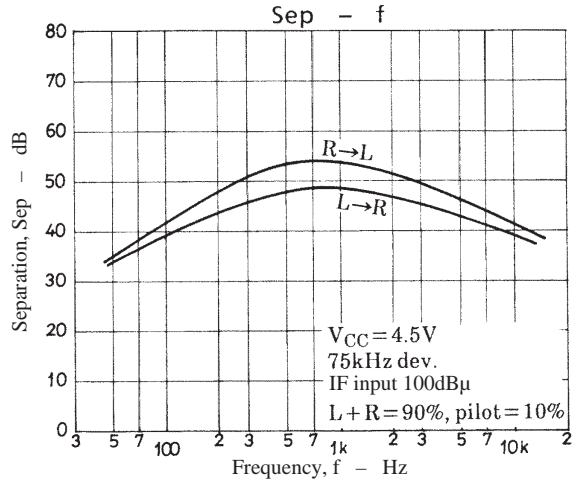
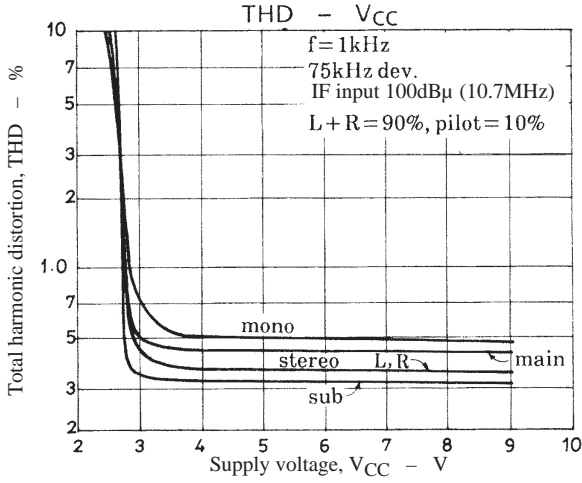

Figure 13

8. If a noise appears in the detection output when the tuning LED goes ON at the AM mode, connect a capacitor across pin 8 and GND to eliminate the noise.









# LA1805

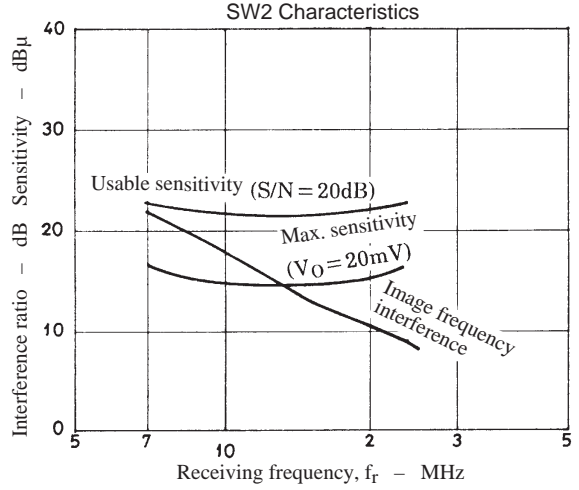
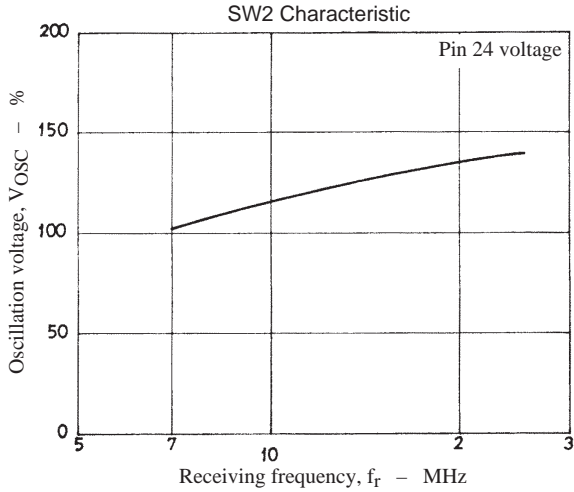

## SW Band Test Circuit

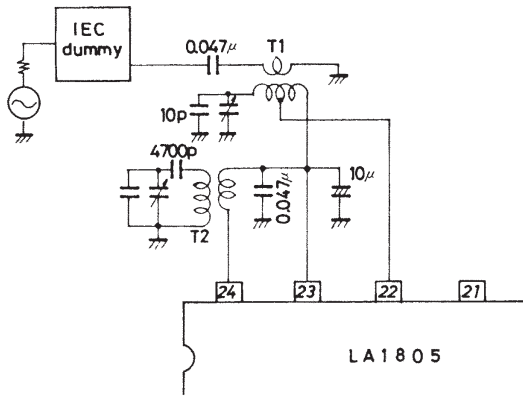

Unit (capacitance : F)

T1 : YT-30117 (Mitsumi), 2158-4095-319A (Sumida)

T2 : HW-40184 (Mitsumi), 0237-1500 (Sumida)

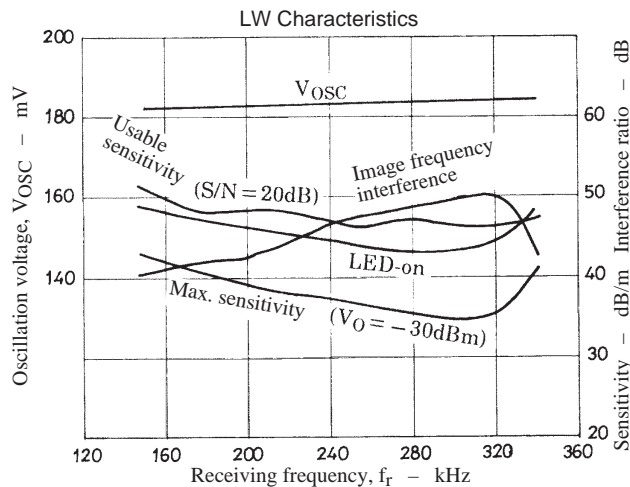
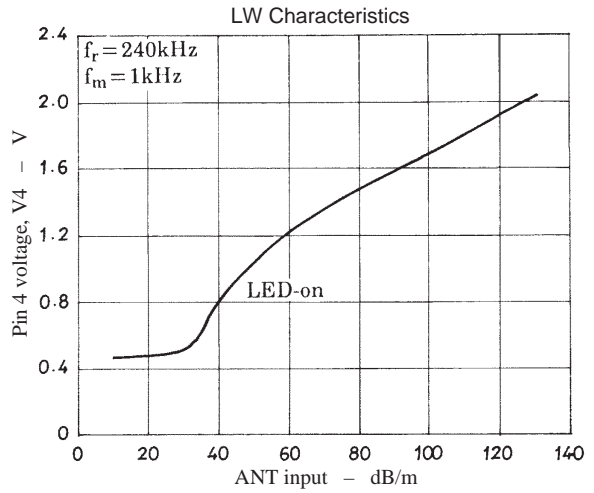
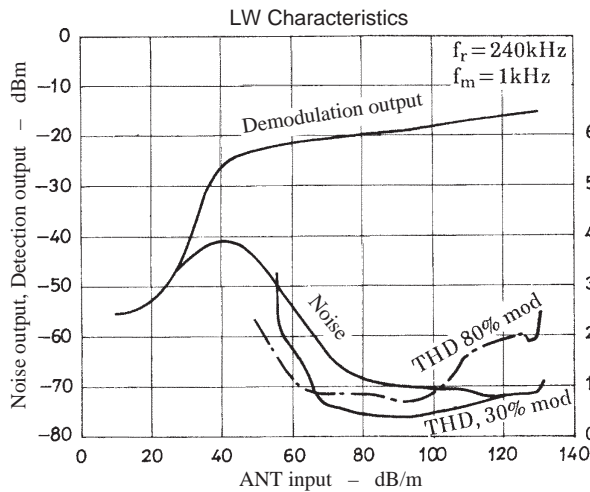

## LW Band Test Circuit

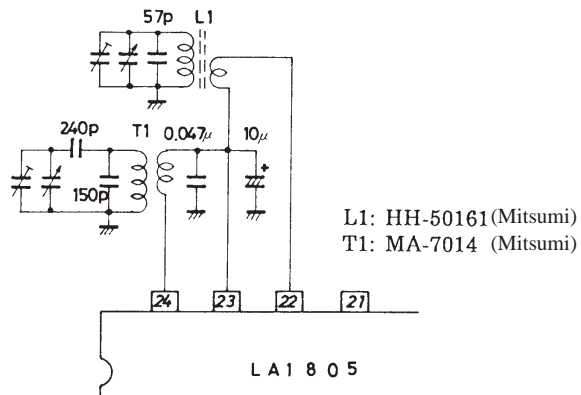

L1: HH-50161 (Mitsumi)

T1: MA-7014 (Mitsumi)

Unit (capacitance : F)

# LA1805

## Sample Application Circuit : LA1186N+LA1805 FM/MW

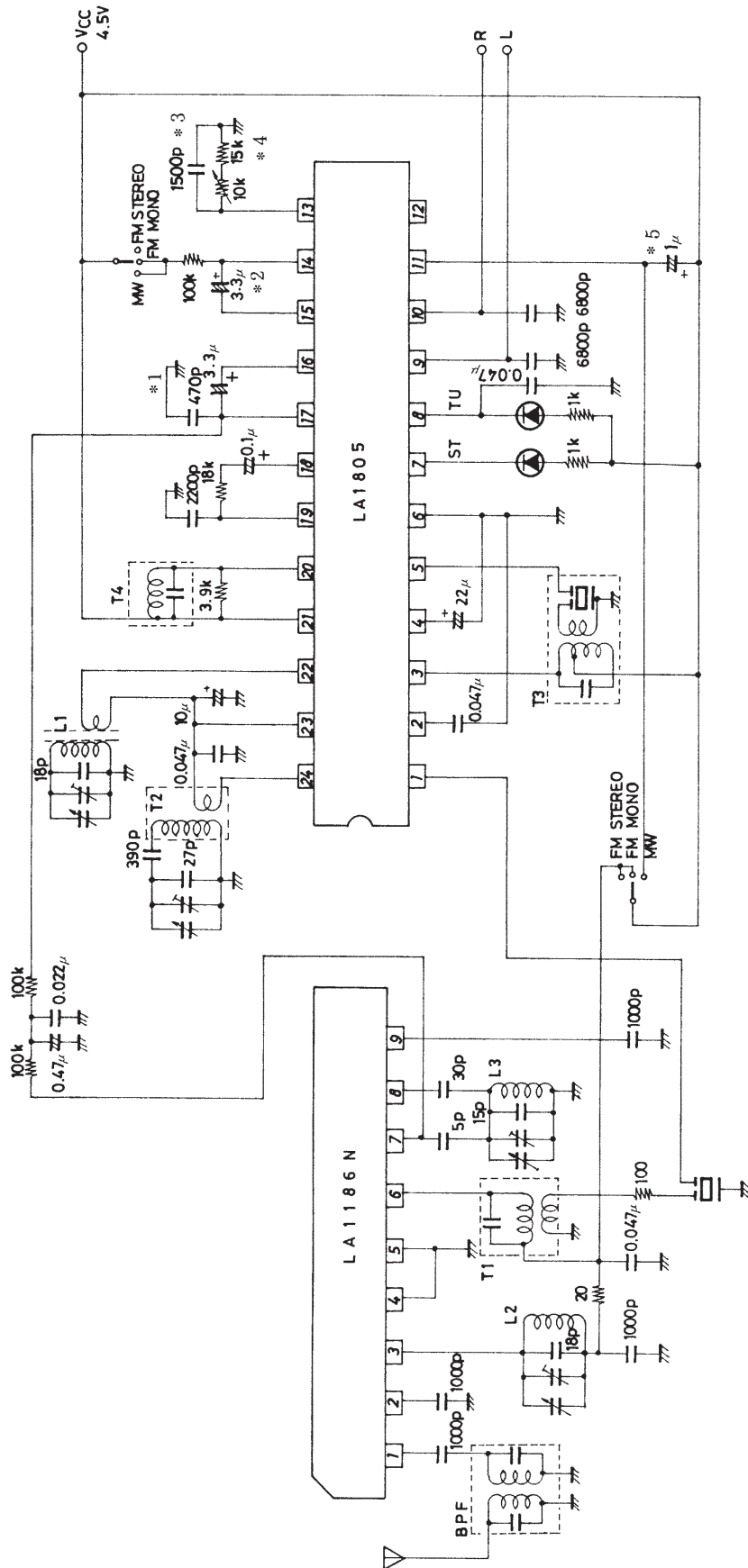

- L1: TN-10896 (Mitsumi)
- L2: YT-30196 (Mitsumi)
- L3: YT-40001 (Mitsumi)
- T1: YT-30224 (Mitsumi)
- T2: HW-6193 (Mitsumi)
- T3: HW-6215 (Mitsumi)
- T4: YT-30103 (Mitsumi)

Note : The constants of parts \*1 to \*5 are changed from those of the LA1810.

Unit (resistance : Ω, capacitance : F)



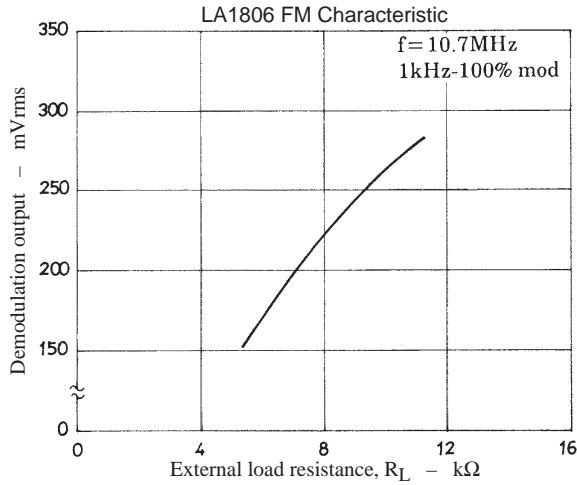

### Coil Specifications

- MW bar antenna  
TN-10896 (Mitsumi)

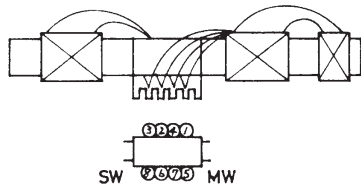

- ①-② 22T + 49T, ③-④ 10T
- ⑤-⑥ 17T, 0.5 $\phi$
- ⑦-⑧ 4T
- ①-②  $L = 260\mu\text{H}$ ,  $Q_0 = 330 (\geq 200)$
- ⑤-⑥  $L = 15\mu\text{H}$ ,  $Q_0 = 250 (\geq 150)$

- AM IFT  
HW-6215 (Mitsumi) HW-6194 SFU-450B

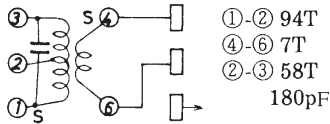

- ①-② 94T
- ④-⑥ 7T
- ②-③ 58T
- 180pF

- MW OSC  
HW-6193 (Mitsumi)

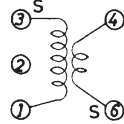

- ⑥-④ 32T
- ③-① 64T
- $Q_0 = 140$ ,  $L = 140\mu\text{H}$

- FM quadrature  
YT-30103 (Mitsumi)

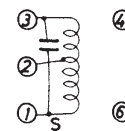

- ①-③ 10T
- $Q_0 = 90$ ,  $f = 10.7\text{MHz}$
- 82pF

- SW2 OSC  
HW-40184 (Mitsumi)

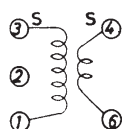

- ④-⑥ 8T
- ③-① 12T
- $Q_0 \geq 28$ ,  $L = 1.31\mu\text{H}$

- 0237-1500 (Mitsumi)

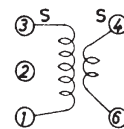

- ④-⑥ 8T
- ③-① 12T
- $Q_0 \geq 20$ ,  $L = 1.31\mu\text{H}$

- SW2 ANT  
YT-30117 (Mitsumi)

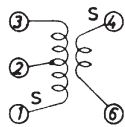

- ①-② 4T
- ④-⑥ 2T
- ②-③ 4T
- $Q_0 = 95$ ,  $L = 1.4\mu\text{H}$

- 2158-4095-319A (Sumida)

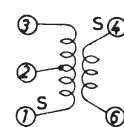

- ④-⑥ 2T
- ①-② 5T
- ②-③ 5T
- $Q_0 \geq 40$ ,  $L = 1.4\mu\text{H}$

- LW bar antenna  
HH-50161 (Mitsumi)

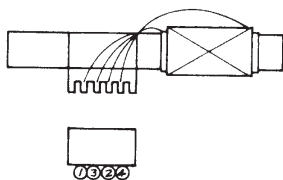

- ①-② 20T
- ③-④ 200T
- ③-④  $L = 2.74\text{mH}$ ,  $Q_0 \geq 200$

- LW OSC  
MA-7014 (Mitsumi)

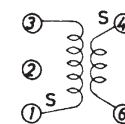

- ④-⑥ 40T
- ①-③ 80T
- $L = 220\mu\text{H}$ ,  $Q_0 = 130$

- No products described or contained herein are intended for use in surgical implants, life-support systems, aerospace equipment, nuclear power control systems, vehicles, disaster/crime-prevention equipment and the like, the failure of which may directly or indirectly cause injury, death or property loss.
- Anyone purchasing any products described or contained herein for an above-mentioned use shall:
  - ① Accept full responsibility and indemnify and defend SANYO ELECTRIC CO., LTD., its affiliates, subsidiaries and distributors and all their officers and employees, jointly and severally, against any and all claims and litigation and all damages, cost and expenses associated with such use:
  - ② Not impose any responsibility for any fault or negligence which may be cited in any such claim or litigation on SANYO ELECTRIC CO., LTD., its affiliates, subsidiaries and distributors or any of their officers and employees jointly or severally.
- Information (including circuit diagrams and circuit parameters) herein is for example only; it is not guaranteed for volume production. SANYO believes information herein is accurate and reliable, but no guarantees are made or implied regarding its use or any infringements of intellectual property rights or other rights of third parties.

This catalog provides information as of January, 1998. Specifications and information herein are subject to change without notice.