



LA3375

Pilot Cancel-Provided PLL FM MPX Demodulator for Car Stereos

Overview

The LA3375 integrates two functions : skip-noise prevention and pilot cancelling. It is a multiplex, 16-pin IC for FM car stereos.

Functions

- Pilot-cancelling (level-following).
- Stereo noise controlling (SNC).
- High-cut control (HCC).
- Stereo-monaural automated selection (with priorities for pilot inputs).
- VCO oscillation damping.

Features

- Low distortion (0.05% typ., 300-mV input, mono.).
- Power supply ripple rejection (35 dB typ.).
- Wide operating voltage range ($V_{CC}=6.5$ to 14V).
- Small due to single-ended package.
- 3 mm pitch-pin spacing makes it easy to use in printed circuit boards.

Package Dimensions

unit:mm

3193-SIP16Z

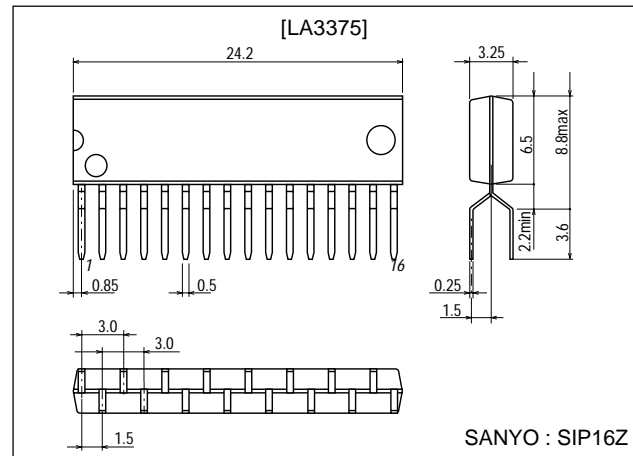

Specifications

Absolute Maximum Ratings at $T_a = 25^\circ\text{C}$

Parameter	Symbol	Conditions	Ratings	Unit
Maximum supply voltage	V_{CC} max		16	V
Lamp driving current	I_L max		40	mA
Allowable power dissipation	P_d max	$T_a \leq 45^\circ\text{C}$	520	mW
Operating temperature	T_{opr}		-20 to +70	$^\circ\text{C}$
Storage temperature	T_{stg}		-40 to +125	$^\circ\text{C}$

Recommended Operating Conditions at $T_a = 25^\circ\text{C}$

Parameter	Symbol	Conditions	Ratings	Unit
Recommended power supply voltage	V_{CC}		6.5 to 14	V
Input signal voltage	v_i		200 to 300	mV

■ Any and all SANYO products described or contained herein do not have specifications that can handle applications that require extremely high levels of reliability, such as life-support systems, aircraft's control systems, or other applications whose failure can be reasonably expected to result in serious physical and/or material damage. Consult with your SANYO representative nearest you before using any SANYO products described or contained herein in such applications.

■ SANYO assumes no responsibility for equipment failures that result from using products at values that exceed, even momentarily, rated values (such as maximum ratings, operating condition ranges, or other parameters) listed in products specifications of any and all SANYO products described or contained herein.

SANYO Electric Co.,Ltd. Semiconductor Company

TOKYO OFFICE Tokyo Bldg., 1-10, 1 Chome, Ueno, Taito-ku, TOKYO, 110-8534 JAPAN

10700TH (KT)/90196RM/D177KI/8044KI/5205KI/ No.901-1/11

LA3375

Operating Characteristics at $T_a = 25^\circ\text{C}$, $V_{CC}=10\text{V}$, $v_i=300\text{mV}$, $f=1\text{kHz}$, $L+R=90\%$, $\text{pilot}=10\%$, $R_g=20\text{k}\Omega$,

See specified Test Circuit.

Parameter	Symbol	Conditions	Ratings			Unit
			min	typ	max	
Quiescent current	I_{CCO}			22	28	mA
Channel separation	Sep	SW1 : B	40	50		dB
Monaural distortion factor	mono THD	mono=300mV		0.05	0.2	%
Stereo distortion factor	ST THD	main		0.05	0.2	%
Lamp lighting level	V_L	L+R=90%, pilot=10%	60	85	120	mV
Hysteresis	h_y			3	6	dB
Capture range	CR	pilot=30mV		± 3		%
Output signal level	v_o	sub	150	215	300	mV
S/N ratio	S/N	$R_g=20\text{k}\Omega$	68	74		dB
		$R_g=10\text{k}\Omega$	70	78		dB
Input resistance (pin 3)	r_i			20		$\text{k}\Omega$
SCA rejection ratio	SCA_{rej}			80		dB
Allowable input voltage	v_i	THD=1%, $R_g=20\text{k}\Omega$	700	900		mV
		THD=1%, $R_g=10\text{k}\Omega$		450		mV
SNC output attenuation	$A_{tt\ SNC}$	$V_8=0.6\text{V}$, L-R=90%, pilot=10%	-8.5	-3.0	-0.3	dB
SNC output voltage	$v_o\ sub$	$V_8=0.1\text{V}$, L-R=90%, pilot=10%			5	mV
HCC output attenuation	$A_{tt\ HCC\ (1)}$	$V_7=0.6\text{V}$, L+R=90%, pilot=10%	-15.0	-9.0	-0.5	dB
	$A_{tt\ HCC\ (2)}$	$V_7=1\text{V}$, L+R=90%, pilot=10%	-2.0		0	dB
Power supply ripple rejection	R_r			35		dB
VCO stopping voltage	VCO stop			7.3		V
Channel balance	CH Ba			0.5	1.5	dB
Pilot cancellation factor	CL_p		20	25		dB

Note : SW1 : A, SW2 : C unless otherwise specified.

Specified test circuit

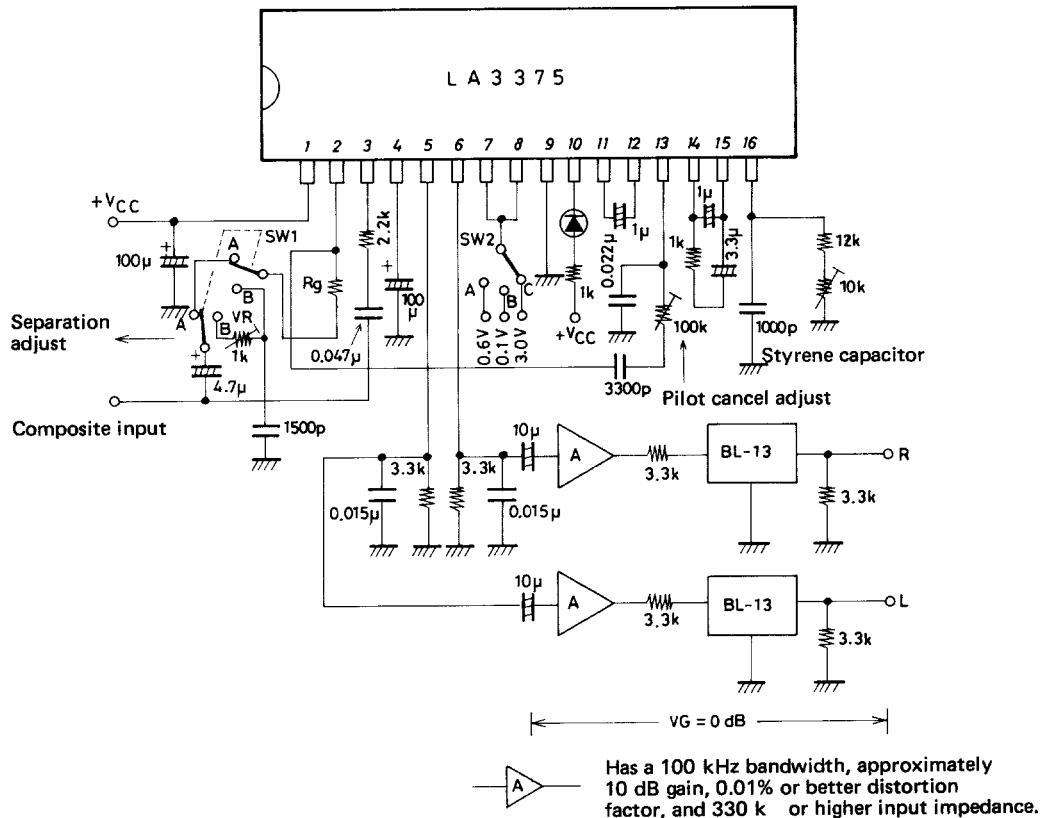

LA3375

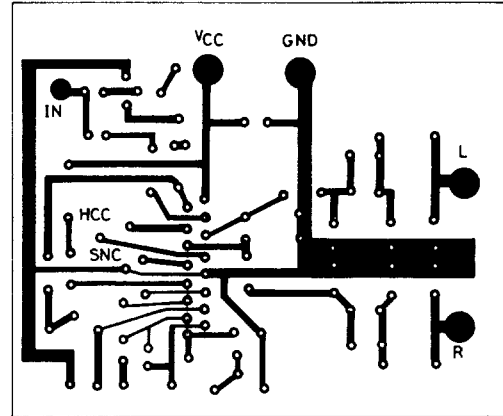
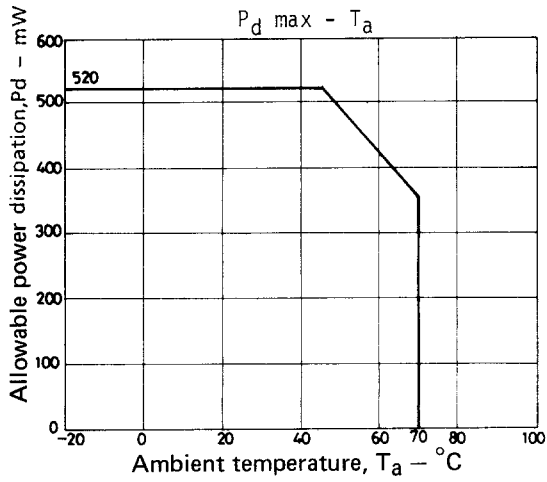

Sample printed circuit pattern

Sample application circuit 1

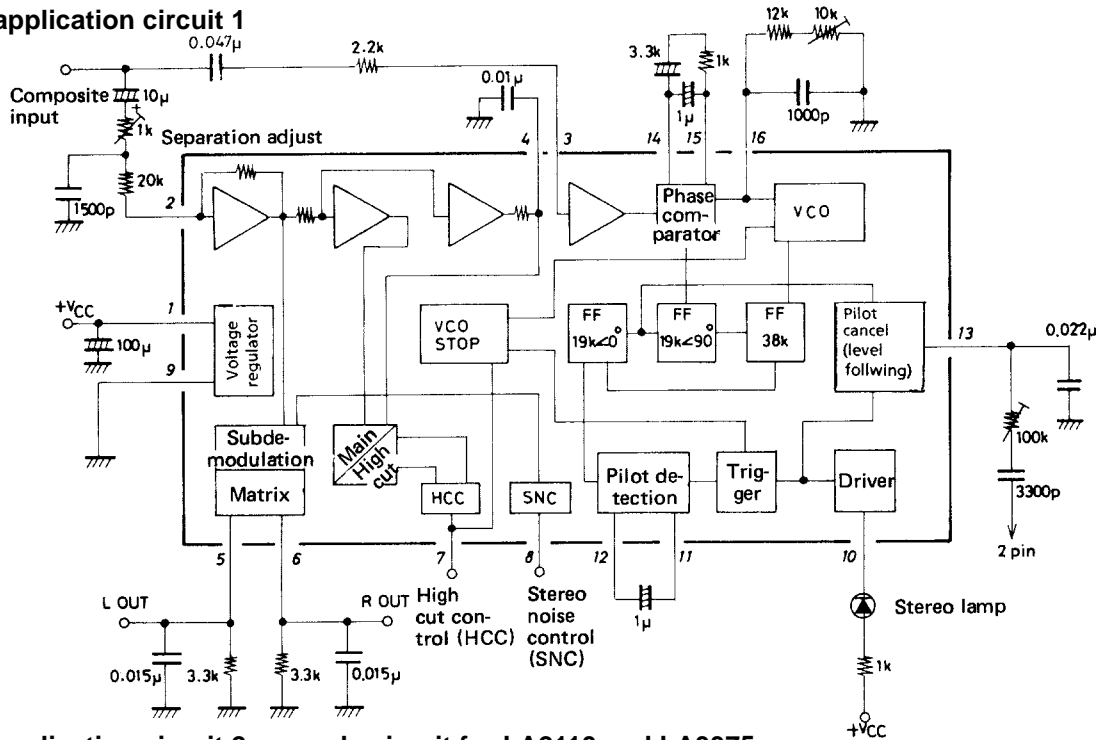

Sample application circuit 2 : sample circuit for LA2110 and LA3375

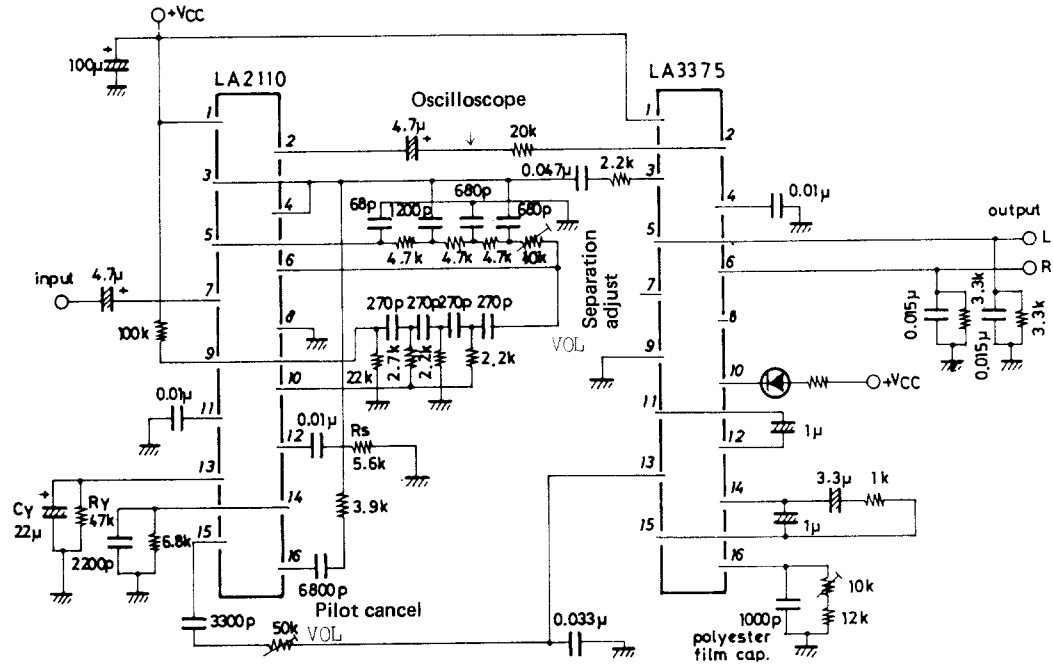

LA3375

Cautions when employing sample application circuits

- 1) Adjust separation by 10kΩ potentiometer in low pass filter.
- 2) Adjust R_S for noise detection sensitivity under strong to medium radio fields. Set at appropriate value.
- 3) Adjust noise AGC by C_Y and R_Y to enhance noise suppression in medium to weak radio fields.
- 4) Adjust pilot cancellation by 50kΩ potentiometer connected to pin 15 of LA2110.
- 5) Reponse speeds of pilot cancellation to follow levels can be varied by adjusting capacitance value of 1μF capacitor connected across pins 11 and 12 of LA3375. Distortion factors deteriorate with reduction in value.
- 6) Adjusting pilot cancellation.

For example consider the sample application circuit 2. Assume the input signal consists only of pilot signals. First connect an oscilloscope and a valve voltmeter to pin 2 of the LA2110. Set their ranges for V : 200mV/div. AC, H : 20μs/div.

When oscilloscope waveform is

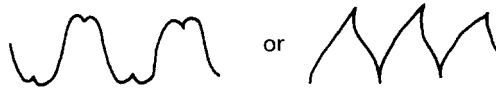

turn pilot cancel control to change it to the following :



Then, adjust pilot cancel control to minimize indications of valve voltmeter.

When the LA3375 alone is used (sample application circuit 1), adjust cancel control through a 19kHz BPF to minimize carrier leakage level at output pins (pins 5 and 6).

*Refer to the LA2110 catalog for LA3375/LA2110 applications and characteristics.

1. Pilot cancelling circuit

A level-following type has been used. Once set, it can easily accommodate varying pilot modulation depths among stations. Cancelling signal is a sawtooth wave obtained by integrating a square wave that is proportionate in amplitude to pilot level with C and R.

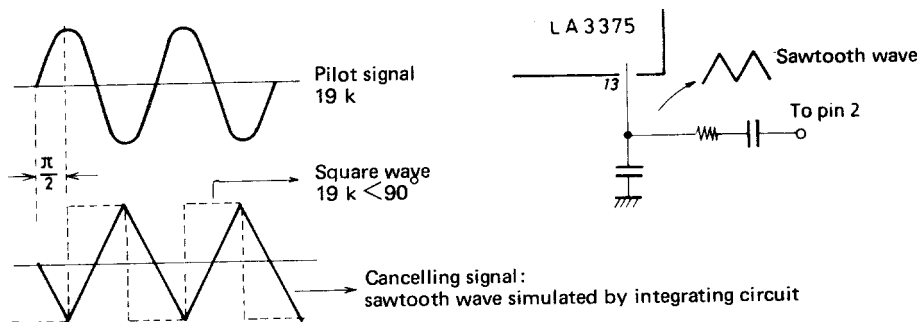

2. Separation adjustments

The LA3375 has separation parameters that have been set to provide maximum separation when used in conjunction with the LA2210, a noise-canceller IC, or the equivalent. The LA3375 by itself exhibits separation only in a 25 to 30 dB range. If a phase correction circuit is provided in the LA3375 input circuit, it can exhibit intrinsic separation characteristics, typically 50 dB.

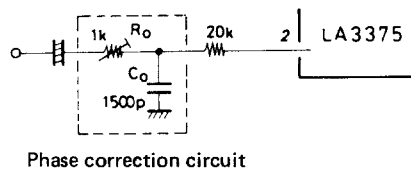

3. Adjusting the free running frequency

Use a timing set resistor and a semi-set resistor, when connecting a frequency counter. Connect the counter with a high impedance input to the connection between these resistors with a 100-kΩ resistor, as shown below.

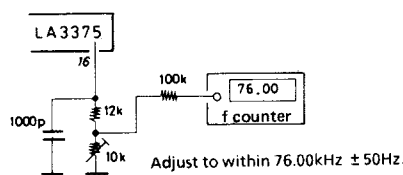

4. SNC (stereo noise control) and HCC (high-cut control)

The LA3375 has SNC and HCC terminals for improved S/N ratios when operating in weak radio fields. By adjusting the SNC terminal, noises unique to stereo FM in weak fields can be reduced. The HCC terminals permits further improvement of effective S/N ratios by lowering treble levels of FM noises in weak fields. (See Fig. 2)

STEREO deteriorates approximately 21.7 dB (compared to MONO) in weak radio feilds (Fig. 2). Generally, when S/N ratios deteriorate below 30 to 40 dB, noises become quite noticeable. Section (1) shows ways to set SNC and HCC when radio field strengths are divided into 3 regions, A, B, and C, (Fig. 2). SNC is expected to function in region A, and HCC in region B. In region C, shallow muting is effected in the IF stage.

(1) SNC (stereo noise control)

Stereo S/N ratios deteriorate 21.7 dB below monaural but can be improved by varying stereo separation. S/N improvement becomes apparent, however, only when the separation is 20 dB or worse. In that case, the relation between separation and S/N improvement is shown in Fig. 5.

SNC in the LA3375 improves S/N ratios in weak radio fields by varying separation. It varies subsignal demodulation level and controls separation. By using the IF stage signal meter level output as the source of the control signal, S/N ratios in region A of Fig. 2 can be maintained at about 40 dB or better. Ideal S/N enhancements should provide gradual switching over from stereo to monaural to maintain constant S/N ratios, starting from a point in region A for 40-dB stereo S/N toward a point for 40-dB monaural S/N. Methods to set the control level will be described later.

Fig. 3 shows voltages applied to pin 8 (SNC terminal) of the LA3375 versus separation characteristics (SNC characteristics). Pin 8 is also the base of a PNP transistor, so stereo mode is set when pin 8 is open and monaural mode is set when it is grounded. SNC terminal control is effective only when locked with pilot signals and when stereo indicator is lit. External circuit parameters can be chosen in large values that do not affect the IF stage meter output circuit because SNC control currents are small. This makes designing easy. (See Fig. 6)

(2) Designing external circuits for SNC characteristics

We recommend the following as a way to designate SNC characteristics to have smooth transition of separation from stereo to monaural in region A of Fig. 2.

Separation vs S/N-enhancement relation Refer to Fig. 5.

SNC terminal voltages vs separation characteristics Refer to Fig. 3.

Antenna inputs vs S/N improvement characteristics can be obtained from the drawing if the graph for IF-stage signal meter output vs antenna iuput and the graph for stereo S/N-ratio vs antenna input are known. From desired S/N characteristics, SNC terminal voltage characteristics can also be obtained.

Sample drawings are shown in Fig. 4, where for simplicity's sake, SNC, IF meter, and stereo S/N characteristics have been approximated with straight lines.

For instance :

To obtain stereo S/N improvement characteristics from SNC characteristics, when (a) in the second quadrant of the chart represents bare SNC characteristics, point 1 projected to the third quadrant shows a 20 dB separation and a 1 dB S/N improvement. When projected from the frist to the fourth quadrant, a point improved by 1 dB in S/N over the stereo S/N line in the fourth quadrant corresponds to point 1.

Similarly, point 2 on the SNC characteristics in the second quadrant corresponds to point 2 in the fourth quadrant. Point 3 in the second quadrant corresponds to point 3 in the fourth quadrant. Stereo S/N improvement characteristics for each point are obtainable.

Similarly, (b) characteristics in the second quadrant are projected to form (b) characteristics in the fourth quadrant, and (c) in the second quadrant to form (c) in the fourth quadrant, thus providing a way to diagram improvement characteristics.

In the resulting drawings, ideal S/N improvement characteristics are similar to (b) in the fourth quadrant, but corresponding SNC characteristics have to be (b) characteristics in the second quadrant which are difficult to realize. Among realistic characteristics, something like (c) appears to be satisfactory. The (c) SNC characteristics are obtained with a shift by two diodes together with a 1/2 bleeder.

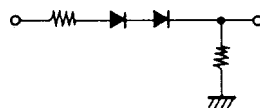

(3) HCC (high-cut control)

In region B where S/N deteriorates to 40 dB or worse even for monaural, the S/N as sensed by the human ear can be enhanced by suppressing levels at frequencies above approximately 7kHz.

Treble region levels that follow meter voltages can be smoothly attenuated (high-cut control) by impressing IF-stage signal meter output to the HCC pin (pin 7) of the LA3375. Fig. 7 shows MPX output frequency characteristics (monaural) provided by voltages impressed on pin 7. Frequency characteristics for a 100% high cut can be designated by an external capacitor connected to pin 4. An equivalent circuit is shown below where the designation is made by the 5kΩ and the C time constant. Approximate values provided by C as expressed in attenuation at 10kHz are listed in table below : right.

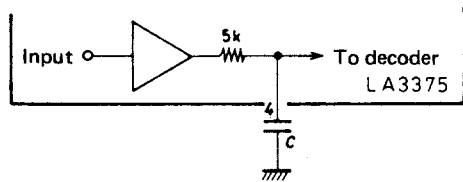

C [μF]	Attenuation at 10 kHz (dB)
0.01	-11
0.033	-21
0.047	-25
0.068	-28

Fig. 8 shows the relation between voltages impressed on pin 7 and rates (%) of high cut (HCC). When IF meter output voltage characteristics and region B, S/N characteristics, of Fig. 2 have been obtained, S/N improvement by HCC can be drawn in a way similar to drawing SNC characteristics.

Fig. 2 shows typical meter outputs of a quadrature detection IF amplifier IC. (Fig. 1 shows data for the LA1140, LA1230, and LA1231N) HCC characteristics have been designated to permit region B improvements when the IC is directly connected to HCC (pin 7) terminal of the LA3375. The infinitesimal control currents at pin 7, similar to pin 8, do not affect meter outputs.

(4) SNC and HCC connection circuits when coupled with the IF stage

Fig. 1 shows sample S/N characteristics vs antenna inputs when SNC and HCC are connected with the IF stage by an external circuit.

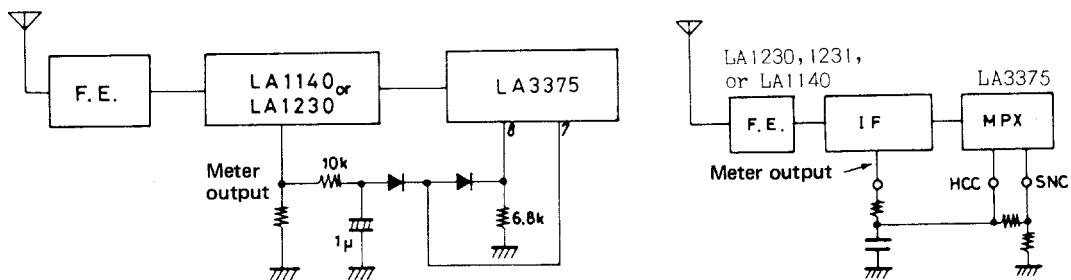

(5) S/N improvements in region C of Fig. 1

Because S/N ratios deteriorate even further in the region C of Fig. 1, it is better to improve the S/N in this region with IF mutings. The LA1140 is available to linearly vary the IF muting. Employment of the LA3375 together with the LA1140 further enhances S/N improvement.

(6) Using the HCC terminal for muting

Mutings in the neighborhood of 37 dB are feasible by utilizing HCC functions as muting functions when used in home stereos and no need exists to suppress treble noises. Fade-in and fade-out of mutings, permitting delightful, shock-noise-free muting are possible by providing a time constant to the pin 7 control.

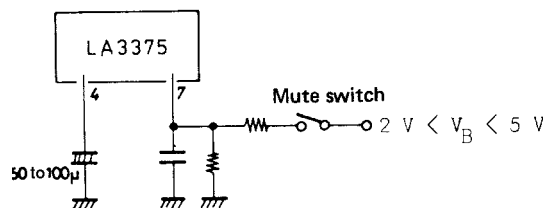

(7) VCO damping

VCO oscillations can be damped by applying a voltage not less than 7 V to the HCC terminal (pin 7) to induce a monaural mode. At this time, both SNC and HCC are in an off mode. Fig. 9 shows flow-in current by voltages applied to pin 7.

Sample weak radio field S/N improvements by the system (Fig. 1)

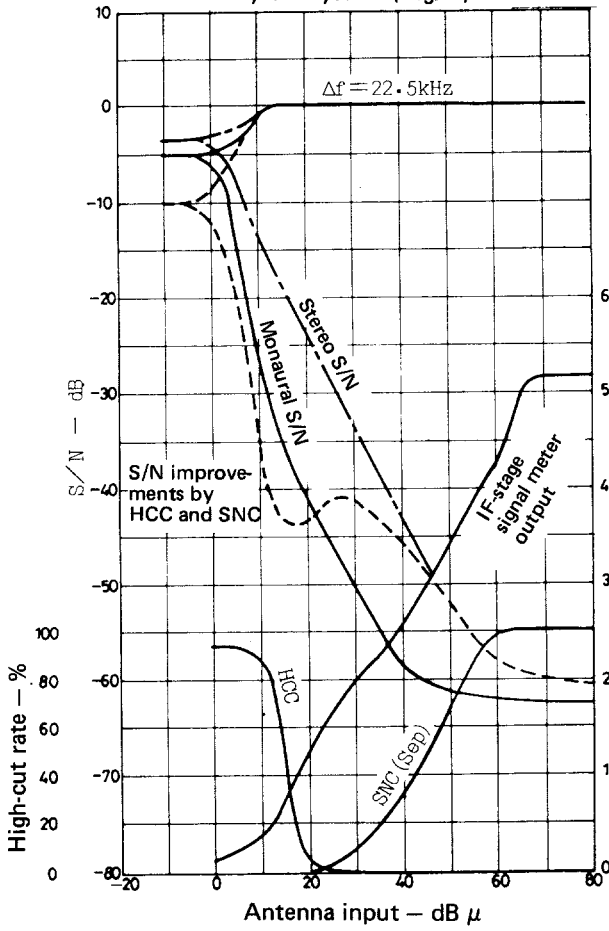

SNC and HCC operating regions (Fig. 2)

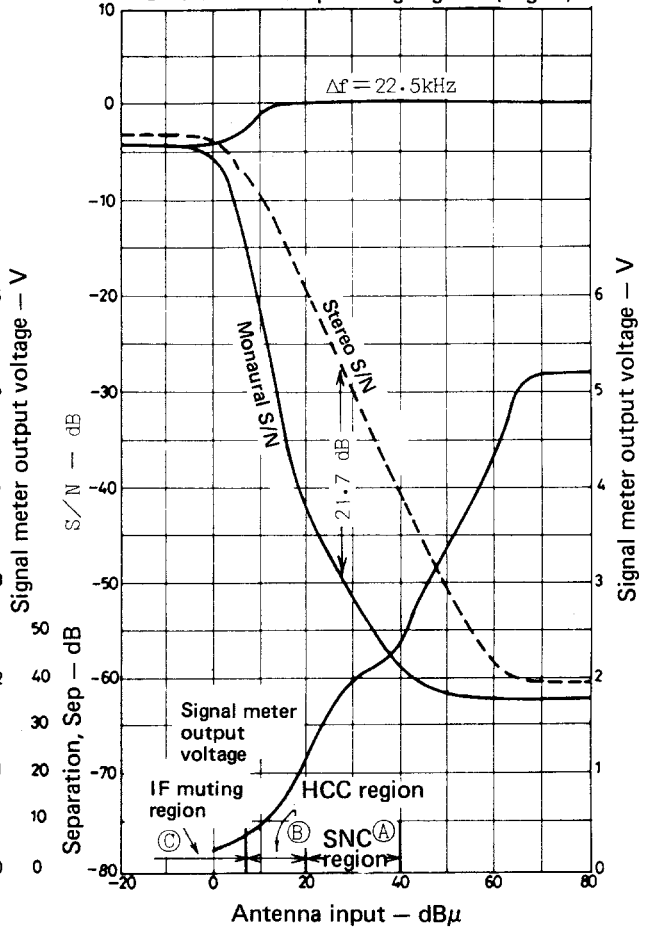

SNC characteristics (Fig. 3)

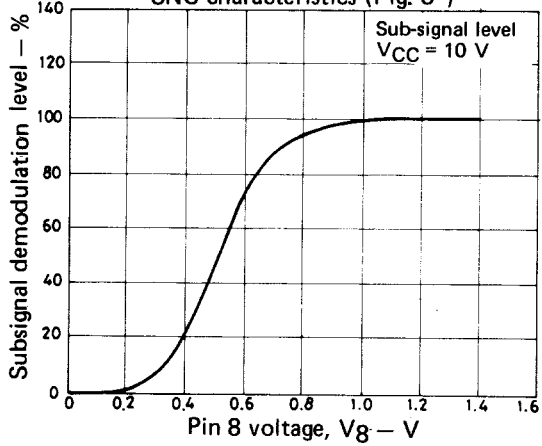
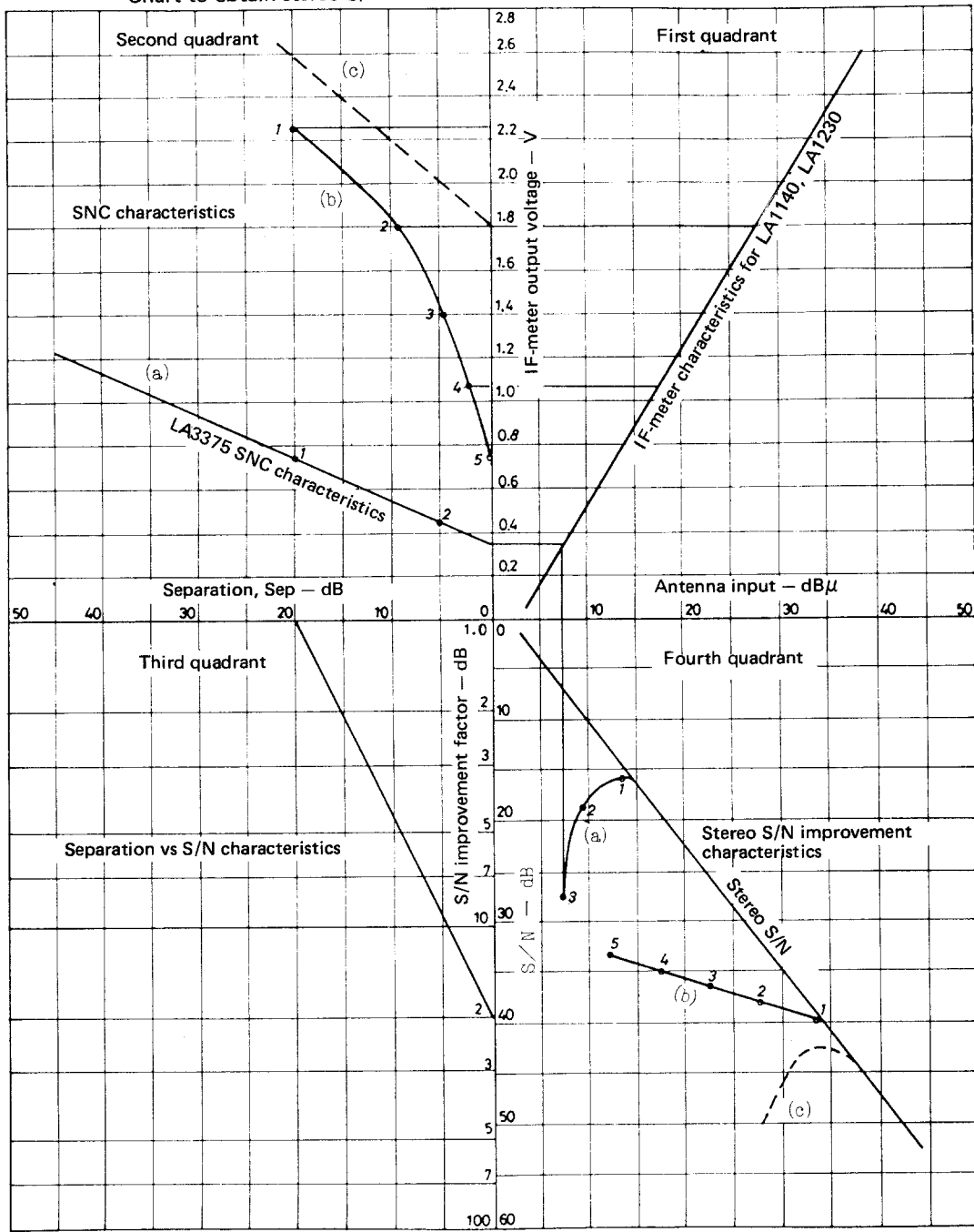
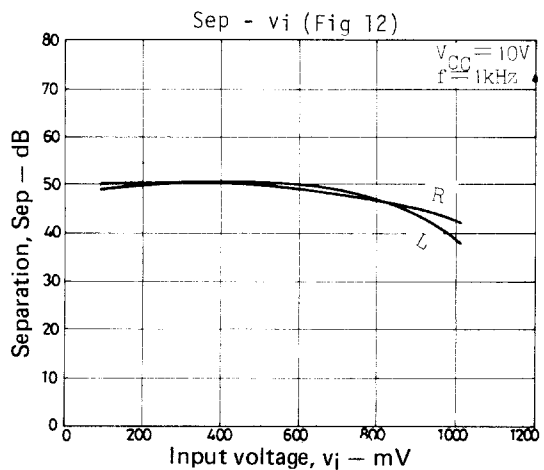
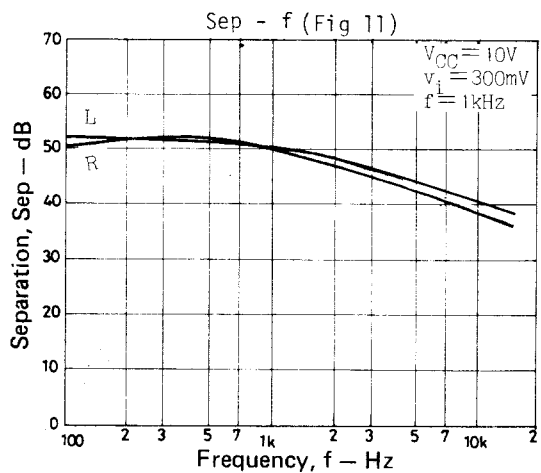
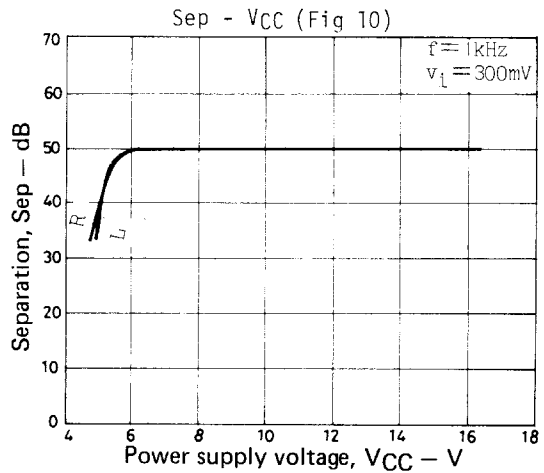
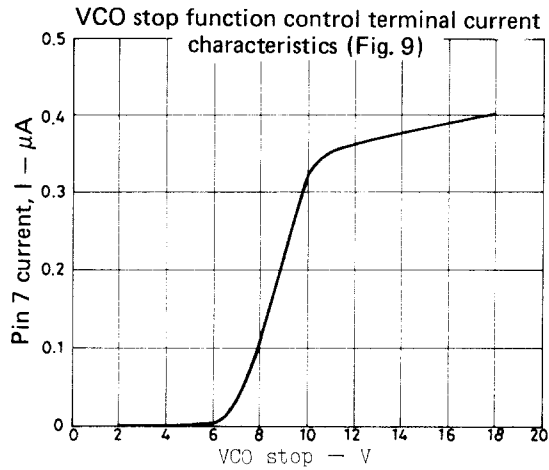
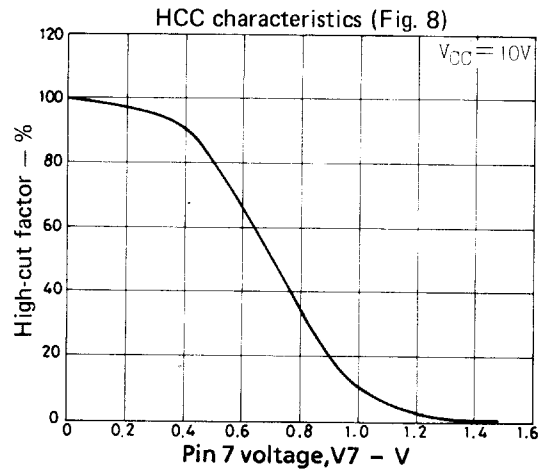
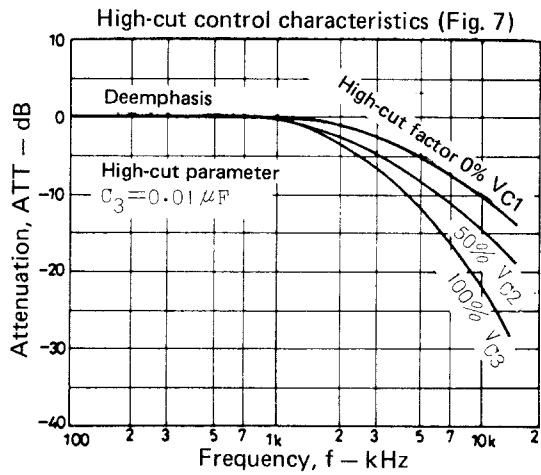
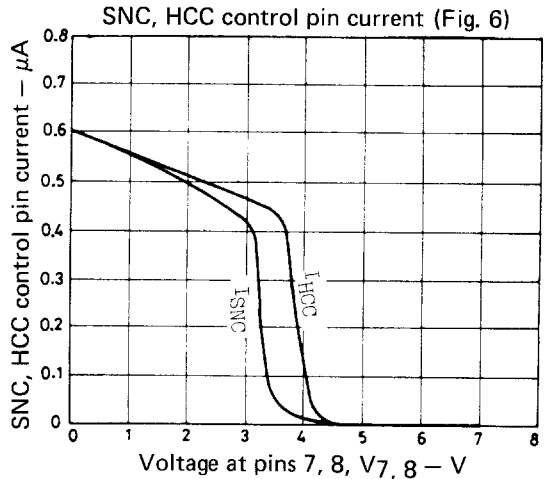
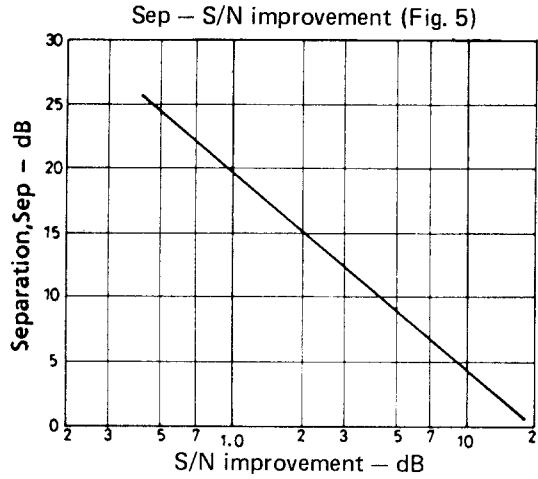
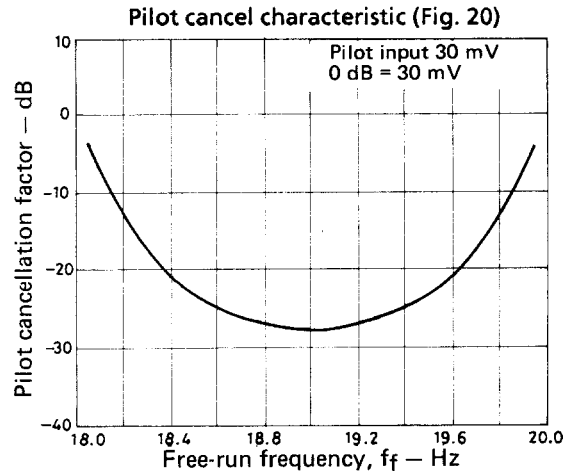
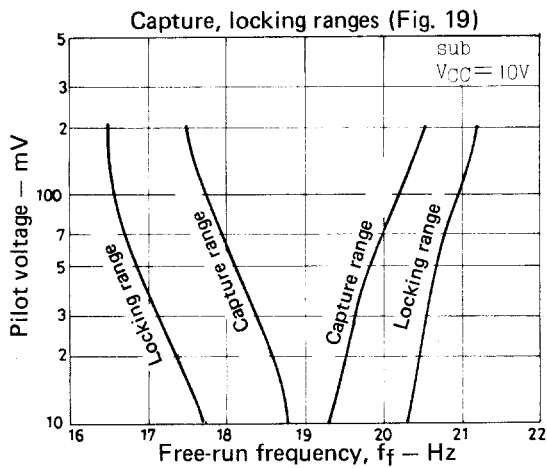
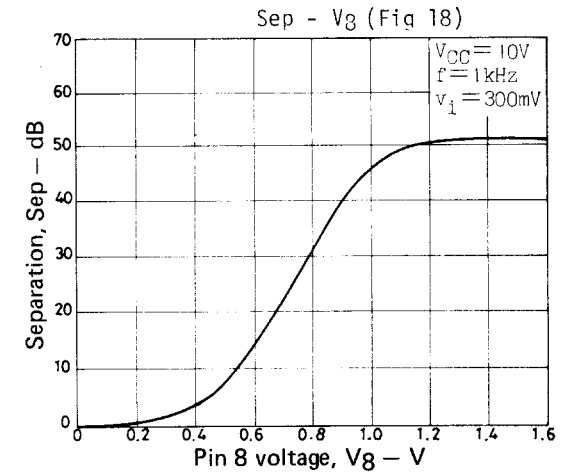
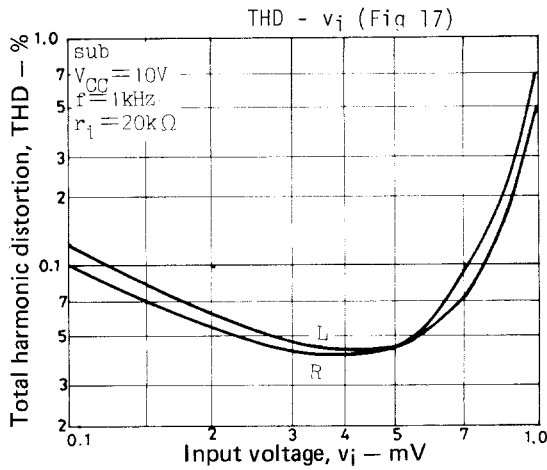
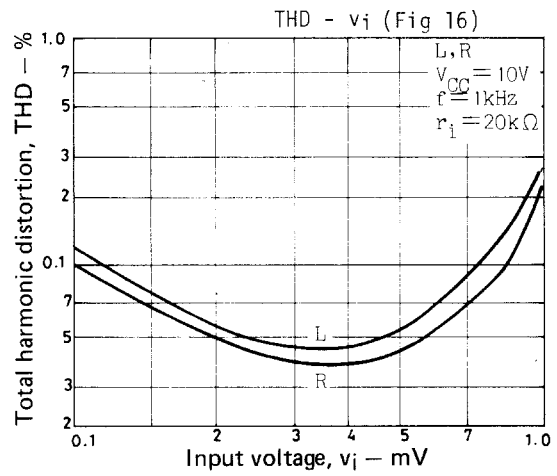
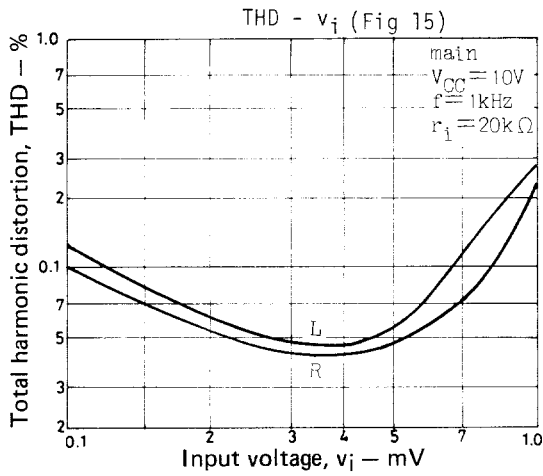
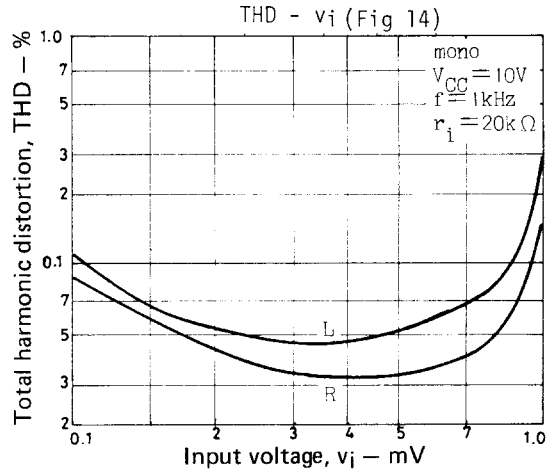
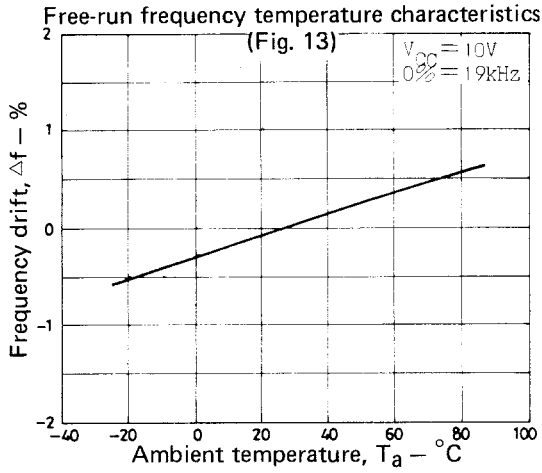
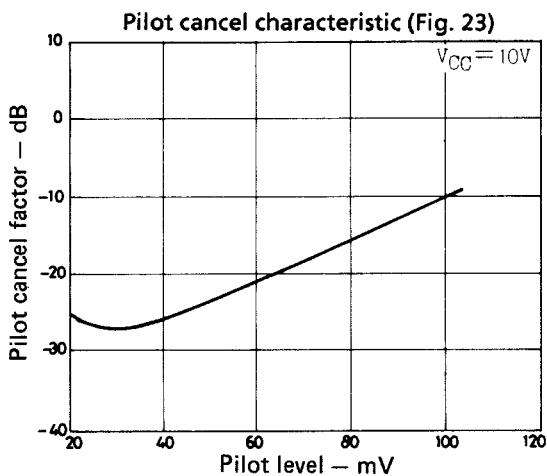
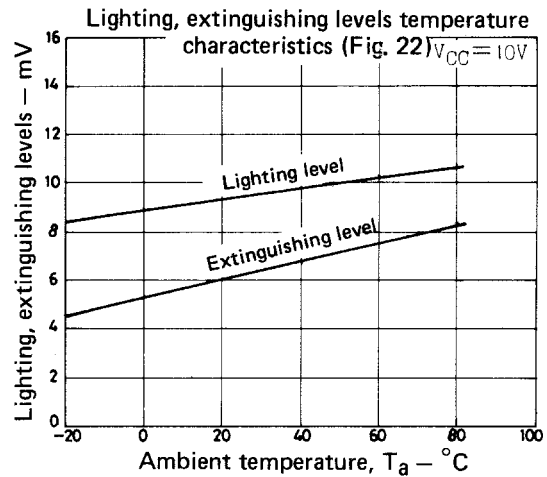
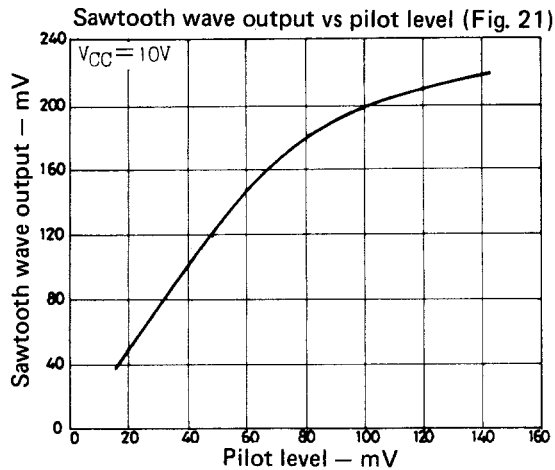

Chart to obtain stereo S/N characteristics from SNC characteristics (Fig. 4)









- Specifications of any and all SANYO products described or contained herein stipulate the performance, characteristics, and functions of the described products in the independent state, and are not guarantees of the performance, characteristics, and functions of the described products as mounted in the customer's products or equipment. To verify symptoms and states that cannot be evaluated in an independent device, the customer should always evaluate and test devices mounted in the customer's products or equipment.
- SANYO Electric Co., Ltd. strives to supply high-quality high-reliability products. However, any and all semiconductor products fail with some probability. It is possible that these probabilistic failures could give rise to accidents or events that could endanger human lives, that could give rise to smoke or fire, or that could cause damage to other property. When designing equipment, adopt safety measures so that these kinds of accidents or events cannot occur. Such measures include but are not limited to protective circuits and error prevention circuits for safe design, redundant design, and structural design.
- In the event that any or all SANYO products (including technical data, services) described or contained herein are controlled under any of applicable local export control laws and regulations, such products must not be exported without obtaining the export license from the authorities concerned in accordance with the above law.
- No part of this publication may be reproduced or transmitted in any form or by any means, electronic or mechanical, including photocopying and recording, or any information storage or retrieval system, or otherwise, without the prior written permission of SANYO Electric Co., Ltd.
- Any and all information described or contained herein are subject to change without notice due to product/technology improvement, etc. When designing equipment, refer to the "Delivery Specification" for the SANYO product that you intend to use.
- Information (including circuit diagrams and circuit parameters) herein is for example only; it is not guaranteed for volume production. SANYO believes information herein is accurate and reliable, but no guarantees are made or implied regarding its use or any infringements of intellectual property rights or other rights of third parties.

This catalog provides information as of January, 2000. Specifications and information herein are subject to change without notice.