

LM2852

2A 500/1500kHz SIMPLE SYNCHRONOUS™ Buck Regulator

General Description

The LM2852 SIMPLE SYNCHRONOUS™ buck regulator is a high frequency step-down switching voltage regulator capable of driving up to a 2A load with excellent line and load regulation. The LM2852 can accept an input voltage between 2.85V and 5.5V and deliver a customizable output voltage that is factory programmable from 0.8V to 3.3V in 100mV increments. The LM2852 is available with a choice of two switching frequencies - 500kHz (LM2852Y) or 1.5MHz (LM2852X). It also features internal compensation to deliver a low component count solution. The exposed-pad TSSOP-14 package enhances the thermal performance of the LM2852.

Features

- Input voltage range of 2.85 to 5.5V
- Factory EEPROM set output voltages from 0.8V to 3.3V in 100mV increments
- Maximum Load Current of 2A
- Voltage Mode Control
- Internal type three compensation
- Switching frequency of 500kHz or 1.5MHz
- Low standby current of 10µA
- Internal 60 mΩ MOSFET switches
- Standard voltage options 1.0/1.2/1.5/1.8/2.5/3.3 volts

Applications

- Low voltage point of load regulators
- Local solution for FPGA/DSP/ASIC core power
- Broadband networking and communications infrastructure
- Portable computing

Typical Application Circuit

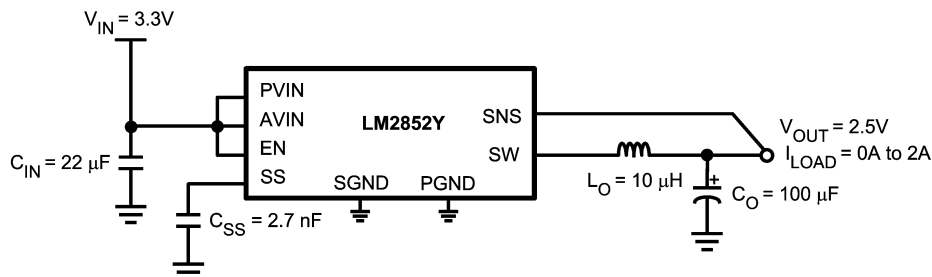

20127001

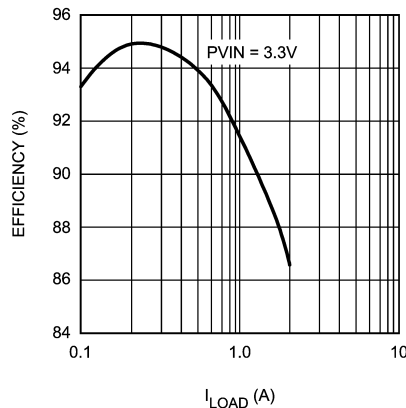

20127002

Connection Diagram

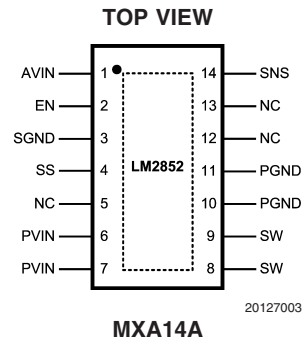

Pin Descriptions

AVIN (Pin 1): Chip bias input pin. This provides power to the logic of the chip. Connect to the input voltage or a separate rail.

EN (Pin 2): Enable. Connect this pin to ground to disable the chip, connect to AVIN or leave floating to enable the chip; enable is internally pulled up.

SGND (Pin 3): Low-noise ground.

SS (Pin 4): Soft-start pin. Connect this pin to a small capacitor to control startup and soften inrush current. The soft-start capacitance range is restricted to values 1 nF to 50 nF.

NC (Pins 5, 12 and 13): No-connect. These pins must be tied to ground or left floating in the application.

PVIN (Pins 6, 7): Input supply pin. PVIN is connected to the input voltage. This rail connects to the source of the internal power PFET.

SW (Pins 8, 9): Switch pin. Connect to the output inductor.

PGND (Pins 10, 11): Power ground. Connect this to an internal ground plane or other large ground plane.

SNS (Pin 14): Output voltage sense pin. Connect this pin to the output voltage as close to the load as possible.

Exposed Pad: Connect to ground.

Ordering Information

Order Number	Frequency	Voltage Option	Package Type	Package Drawing	Supplied As
LM2852YMXA-1.0	500kHz	1.0	TSSOP-14 exposed pad	MXA14A	94 Units, Rail
LM2852YMXAX-1.0					2500 Units, Tape and Reel
LM2852YMXA-1.2		1.2			94 Units, Rail
LM2852YMXAX-1.2					2500 Units, Tape and Reel
LM2852YMXA-1.5		1.5			94 Units, Rail
LM2852YMXAX-1.5					2500 Units, Tape and Reel
LM2852YMXA-1.8		1.8			94 Units, Rail
LM2852YMXAX-1.8					2500 Units, Tape and Reel
LM2852YMXA-2.5		2.5			94 Units, Rail
LM2852YMXAX-2.5					2500 Units, Tape and Reel
LM2852YMXA-3.3		3.3			94 Units, Rail
LM2852YMXAX-3.3					2500 Units, Tape and Reel
LM2852XMXA-1.0	1500kHz	1.0			Coming Soon
LM2852XMXAX-1.0		1.2			
LM2852XMXA-1.2		1.5			
LM2852XMXAX-1.2		1.8			
LM2852XMXA-1.5		2.5			
LM2852XMXAX-1.5		3.3			
LM2852XMXA-1.8					
LM2852XMXAX-1.8					
LM2852XMXA-2.5					
LM2852XMXAX-2.5					
LM2852XMXA-3.3					
LM2852XMXAX-3.3					

Note: Contact factory for other voltage options.

Absolute Maximum Ratings (Note 1)

If Military/Aerospace specified devices are required, please contact the National Semiconductor Sales Office/Distributors for availability and specifications.

PVIN, AVIN, EN, SNS	-0.3V to 6.5V
ESD Susceptibility (Note 2)	2kV
Power Dissipation	Internally Limited
Storage Temperature Range	-65°C to +150°C
Maximum Junction Temp.	150°C
14-Pin Exposed Pad TSSOP	
Package	220°C
Infrared (15 sec)	215°C
Vapor Phase (60 sec)	260°C
Soldering (10 sec)	

Operating Ratings

PVIN to GND	1.5V to 5.5V
AVIN to GND	2.85V to 5.5V
Junction Temperature	-40°C to +125°C
θ_{JA}	37.6°C/W

Electrical Characteristics

AVIN = PVIN = 5V unless otherwise indicated under the **Conditions** column.

Typicals and limits appearing in plain type apply for $T_A = T_J = +25^\circ\text{C}$. Limits appearing in **boldface** type apply over full Operating Junction Temperature Range (-40°C to +125°C). Datasheet min/max specification limits are guaranteed by design, test, or statistical analysis.

Symbol	Parameter	Conditions	Min	Typ	Max	Units
SYSTEM PARAMETERS						
V_{OUT}	Voltage Tolerance ³	$V_{OUT} = 1.0\text{V}$ option	0.9775		1.0225	V
		$V_{OUT} = 1.2\text{V}$ option	1.1730		1.2270	
		$V_{OUT} = 1.5\text{V}$ option	1.4663		1.5337	
		$V_{OUT} = 1.8\text{V}$ option	1.7595		1.8405	
		$V_{OUT} = 2.5\text{V}$ option	2.4437		2.5563	
		$V_{OUT} = 3.3\text{V}$ option	3.2257		3.3743	
$\Delta V_{OUT}/\Delta AVIN$	Line Regulation ³	$V_{OUT} = 0.8\text{V}, 1.0\text{V}, 1.2\text{V}, 1.5\text{V}, 1.8\text{V}$ or 2.5V $2.85\text{V} \leq AVIN \leq 5.5\text{V}$		0.2	0.6	%
		$V_{OUT} = 3.3\text{V}$ $3.5\text{V} \leq AVIN \leq 5.5\text{V}$		0.2	0.6	%
$\Delta V_{OUT}/\Delta I_O$	Load Regulation	Normal operation		8		mV/A
V_{ON}	UVLO Threshold (AVIN)	Rising		2.47	2.85	V
		Falling Hysteresis	85	150	210	mV
$r_{DS(on)-P}$	PFET On Resistance	$I_{sw} = 2\text{A}$		75	140	m Ω
$r_{DS(on)-N}$	NFET On Resistance	$I_{sw} = 2\text{A}$		55	120	m Ω
R_{SS}	Soft-start resistance			400		k Ω
I_{CL}	Peak Current Limit Threshold		2.25	3	3.65	A
I_Q	Operating Current	Non-switching		0.85	2	mA
I_{SD}	Shut Down Quiescent Current	EN = 0V		10	25	μA
R_{SNS}	Sense pin resistance			400		k Ω
PWM						
f_{osc}	LM2852X	1500kHz option.	TBD	1500	TBD	kHz
	LM2852Y	500kHz option.	325	500	625	kHz
D_{range}	Duty Cycle Range		0		100	%

Electrical Characteristics

AVIN = PVIN = 5V unless otherwise indicated under the **Conditions** column.

Typicals and limits appearing in plain type apply for $T_A = T_J = +25^\circ\text{C}$. Limits appearing in **boldface** type apply over full Operating Junction Temperature Range (-40°C to $+125^\circ\text{C}$). Datasheet min/max specification limits are guaranteed by design, test, or statistical analysis. (Continued)

Symbol	Parameter	Conditions	Min	Typ	Max	Units
ENABLE CONTROL⁴						
V_{IH}	EN Pin Minimum High Input		75			% of AVIN
V_{IL}	EN Pin Maximum Low Input				25	% of AVIN
I_{EN}	EN Pin Pullup Current	EN = 0V		1.2		μA
THERMAL CONTROLS						
T_{SD}	T_J for Thermal Shutdown			165		$^\circ\text{C}$
T_{SD-hys}	Hysteresis for Thermal Shutdown			10		$^\circ\text{C}$

Note 1: Absolute maximum ratings indicate limits beyond which damage to the device may occur. Operating Range indicates conditions for which the device is intended to be functional, but does not guarantee specific performance limits. For guaranteed specifications and test conditions, see the Electrical Characteristics.

Note 2: Human body model: 1.5k Ω in series with 100pF. SW and PVIN pins are derated to 1.5kV

Note 3: V_{OUT} measured in a non-switching, closed-loop configuration at the SNS pin.

Note 4: The enable pin is internally pulled up, so the LM2852 is automatically enabled unless an external enable voltage is applied.

Typical Performance Characteristics

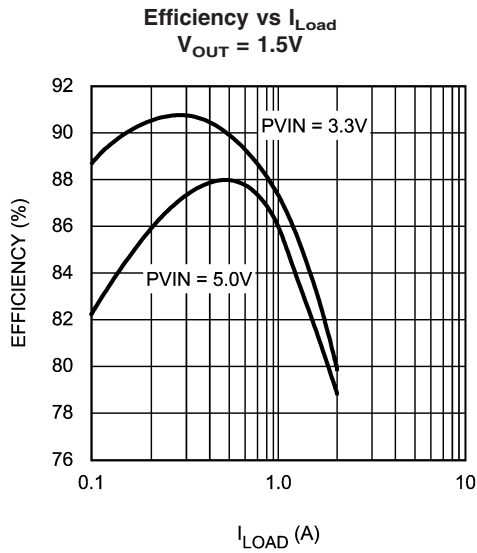

20127004

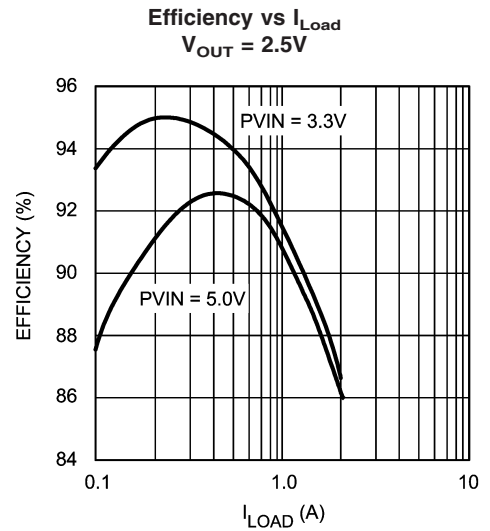

20127024

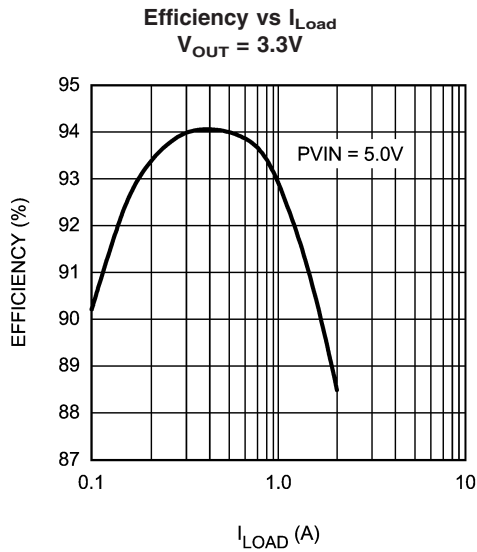

20127006

Quiescent Current (Non-Switching) vs V_{IN} and Temp.

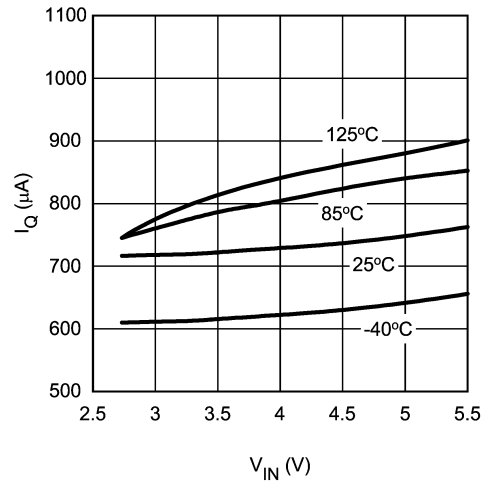

20127007

Shut-Down Current vs V_{IN} and Temp.

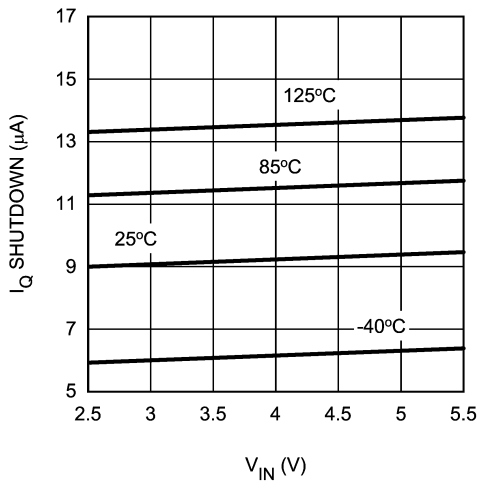

20127008

Frequency vs Temperature and V_{IN}

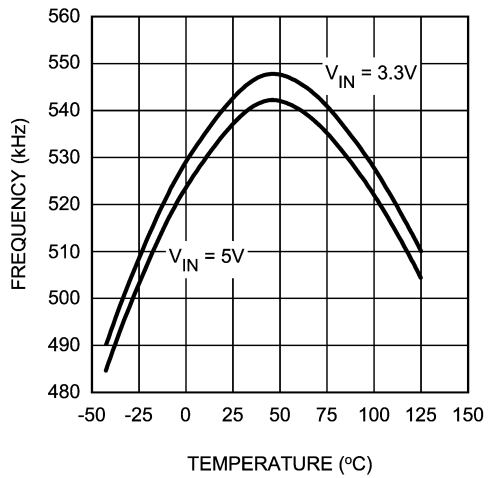

20127009

Typical Performance Characteristics (Continued)

NMOS Switch R_{DSON} vs Temperature and PVIN

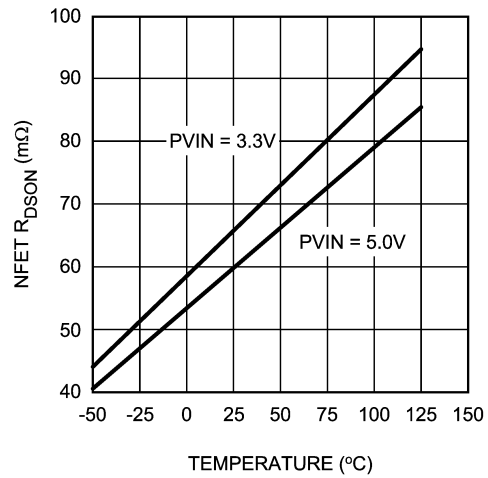

20127010

PMOS Switch R_{DSON} vs Temperature and PVIN

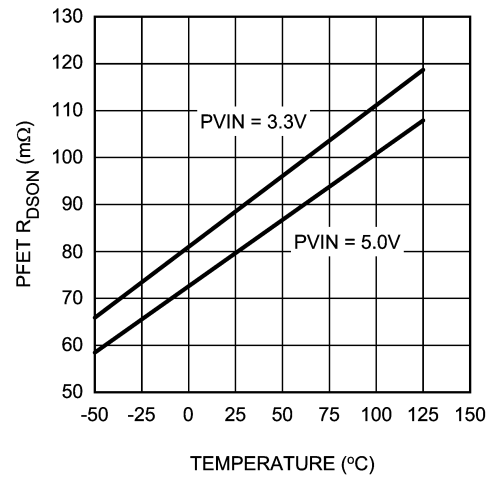

20127011

Block Diagram

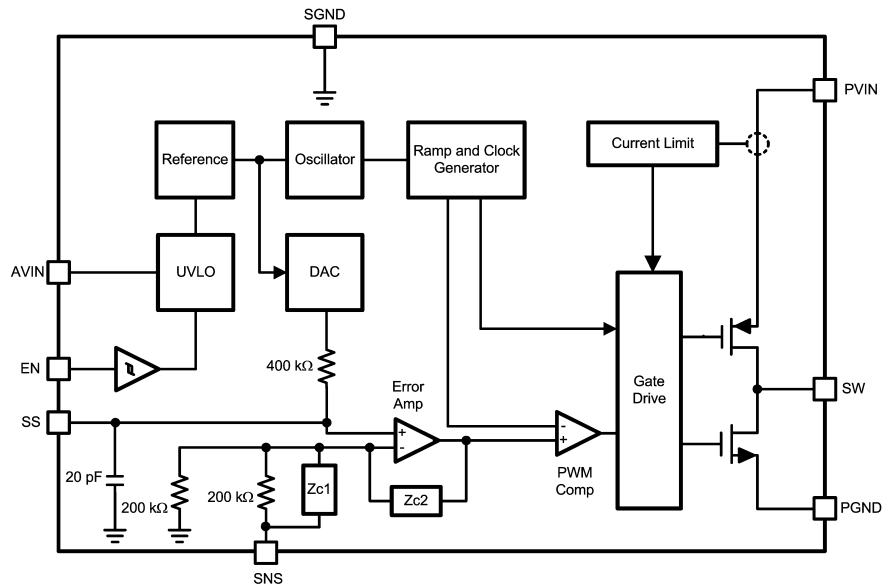

20127012

Applications Information

The LM2852 is a DC-DC buck converter belonging to National Semiconductor's SIMPLE SYNCHRONOUS® family. Integration of the PWM controller, power switches and compensation network greatly reduces the component count required to implement a switching power supply. A typical application requires only four components: an input capacitor, a soft-start capacitor, an output filter capacitor and an output filter inductor.

INPUT CAPACITOR (C_{IN})

Fast switching of large currents in the buck converter places a heavy demand on the voltage source supplying PVIN. The input capacitor, C_{IN} , supplies extra charge when the switcher needs to draw a burst of current from the supply. The RMS current rating and the voltage rating of the C_{IN} capacitor are therefore important in the selection of C_{IN} . The RMS current specification can be approximated to be the load current times the square root of the duty cycle:

$$I_{RMS} = I_{LOAD} \sqrt{D},$$

where D is the duty cycle, V_{OUT}/V_{IN} . C_{IN} also provides filtering of the supply. Trace resistance and inductance degrade the benefits of the input capacitor, so C_{IN} should be placed very close to PVIN in the layout. A 22 μ F or 47 μ F ceramic capacitor is typically sufficient for C_{IN} . In parallel with the large input capacitance a smaller capacitor may be added such as a 1 μ F ceramic for higher frequency filtering.

SOFT-START CAPACITOR (C_{SS})

The DAC that sets the reference voltage of the error amp sources a current through a resistor to set the reference voltage. The reference voltage is one half of the output voltage of the switcher due to the 200k Ω divider connected to the SNS pin. Upon start-up, the output voltage of the switcher tracks the reference voltage with a two to one ratio as the DAC current charges the capacitance connected to the reference voltage node. Internal capacitance of 20pF is

permanently attached to the reference voltage node which is also connected to the soft-start pin, SS. Adding a soft-start capacitor externally increases the time it takes for the output voltage to reach its final level.

The charging time required for the reference voltage can be estimated using the RC time constant of the DAC resistor and the capacitance connected to the SS pin. Three RC time constant periods are needed for the reference voltage to reach 95% of its final value. The actual start-up time will vary with differences in the DAC resistance and higher-order effects.

If little or no soft-start capacitance is connected, then the start-up time may be determined by the time required for the current limit current to charge the output filter capacitance. The capacitor charging equation $I = C \Delta V / \Delta t$ can be used to estimate the start-up time in this case. For example, a part with a 3V output, a 100 μ F output capacitance and a 3A current limit threshold would require a time of 100 μ s:

$$\Delta t = C \frac{\Delta V}{I} = 100 \mu\text{F} \frac{3\text{V}}{3\text{A}} = 100 \mu\text{s}.$$

Since it is undesirable for the power supply to start up in current limit, a soft-start capacitor must be chosen to force the LM2852 to start up in a more controlled fashion based on the charging of the soft-start capacitance. In this example, suppose a 3 ms start time is desired. Three time constants are required for charging the soft-start capacitor to 95% of the final reference voltage. So in this case $RC=1\text{ms}$. The DAC resistor, R, is 400 k Ω so C can be calculated to be 2.5nF. A 2.7nF ceramic capacitor can be chosen to yield approximately a 3ms start-up time.

Applications Information (Continued)

SOFT-START CAPACITOR (C_{SS}) AND FAULT CONDITIONS

Various fault conditions such as short circuit and UVLO of the LM2852 activate internal circuitry designed to control the voltage on the soft-start capacitor. For example, during a short circuit current limit event, the output voltage typically falls to a low voltage. During this time, the soft-start voltage is forced to track the output so that once the short is removed, the LM2852 can restart gracefully from whatever voltage the output reached during the short circuit event. The range of soft-start capacitors is therefore restricted to values 1nF to 50nF.

COMPENSATION

The LM2852 provides a highly integrated solution to power supply design. The compensation of the LM2852, which is

type three, is included on-chip. The benefit to integrated compensation is straight-forward, simple power supply design. Since the output filter capacitor and inductor values impact the compensation of the control loop, the range of L, C and C_{ESR} values is restricted in order to ensure stability.

OUTPUT FILTER VALUES

Table 1 details the recommended inductor and capacitor ranges for the LM2852 that are suggested for various typical output voltages. Values slightly different than those recommended may be used, however the phase margin of the power supply may be degraded.

TABLE 1. Output Filter Values

Frequency Option	V_{OUT} (V)	PV_{IN} (V)	L (μ H)		C (μ F)		C_{ESR} (m Ω)	
			Min	Max	Min	Max	Min	Max
LM2852Y (500kHz)	0.8	3.3	10	15	100	220	70	200
	0.8	5	10	15	100	120	70	200
	1	3.3	10	15	100	180	70	200
	1	5	10	15	100	180	70	200
	1.2	3.3	10	15	100	180	70	200
	1.2	5	15	22	100	120	70	200
	1.5	3.3	10	15	100	120	70	200
	1.5	5	22	22	100	120	70	200
	1.8	3.3	10	15	100	120	100	200
	1.8	5	22	33	100	120	100	200
	2.5	3.3	6.8	10	68	120	95	275
	2.5	5	15	22	68	120	95	275
	3.3	5	15	22	68	100	100	275

CHOOSING AN INDUCTANCE VALUE

The current ripple present in the output filter inductor is determined by the input voltage, output voltage, switching frequency and inductance according to the following equation:

$$\Delta I_L = \frac{D \times (V_{IN} - V_{OUT})}{f \times L},$$

where ΔI_L is the peak to peak current ripple, D is the duty cycle V_{OUT}/V_{IN} , V_{IN} is the input voltage applied to the output stage, V_{OUT} is the output voltage of the switcher, f is the switching frequency and L is the inductance of the output filter inductor. Knowing the current ripple is important for inductor selection since the peak current through the inductor is the load current plus one half the ripple current. Care must be taken to ensure the peak inductor current does not reach a level high enough to trip the current limit circuitry of the LM2852.

As an example, consider a 5V to 1.2V conversion and a 500kHz switching frequency. According to Table 1, a 15 μ H inductor may be used. Calculating the expected peak-to-peak ripple,

$$\Delta I_L = \frac{1.2}{5} \times (5 - 1.2) = 121.6 \text{ mA}$$

The maximum inductor current for a 2A load would therefore be 2A plus 60.8 mA, 2.0608A. As shown in the ripple equation, the current ripple is inversely proportional to inductance.

OUTPUT FILTER INDUCTORS

Once the inductance value is chosen, the key parameter for selecting the output filter inductor is its saturation current (I_{sat}) specification. Typically I_{sat} is given by the manufacturer as the current at which the inductance of the coil falls to a certain percentage of the nominal inductance. The I_{sat} of an inductor used in an application should be greater than the maximum expected inductor current to avoid saturation. Below is a table of inductors that may be suitable in LM2852 applications.

Applications Information (Continued)

TABLE 2. (LM2852Y Output Filter Inductors (500kHz))

Inductance (μH)	Part Number	Vendor
6.8	DO3316P-682	Coilcraft
7	MSS1038-702NBC	Coilcraft
10	DO3316P-103	Coilcraft
10	MSS1038-103NBC	Coilcraft
12	MSS1038-123NBC	Coilcraft
15	DO3316P-153	Coilcraft
15	MSS1038-153NBC	Coilcraft
18	MSS1038-183NBC	Coilcraft
22	DO3316P-223	Coilcraft
22	MSS1038-223NBC	Coilcraft
22	DO3340P-223	Coilcraft
27	MSS1038-273NBC	Coilcraft
33	MSS1038-333NBC	Coilcraft
33	DO3340P-333	Coilcraft

OUTPUT FILTER CAPACITORS

The capacitors that may be used in the output filter with the LM2852 are limited in value and ESR range according to *Table 1*. Below are some examples of capacitors that can typically be used in an LM2852 application.

TABLE 3. LM2852Y Output Filter Capacitors (500kHz)

Capacitance (μF)	Part Number	Chemistry	Vendor
68	595D686X_010C2T	Tantalum	Vishay - Sprague
68	595D686X_016D2T	Tantalum	Vishay - Sprague
100	595D017X_6R3C2T	Tantalum	Vishay - Sprague
100	595D107X_016D2T	Tantalum	Vishay - Sprague
100	NOSC107M004R0150	Niobium Oxide	AVX
100	NOSD107M006R0100	Niobium Oxide	AVX
120	595D127X_004C2T	Tantalum	Vishay - Sprague
120	595D127X_010D2T	Tantalum	Vishay - Sprague
150	595D157X_004C2T	Tantalum	Vishay - Sprague
150	595D157X_016D2T	Tantalum	Vishay - Sprague
150	NOSC157M004R0150	Niobium Oxide	AVX
150	NOSD157M006R0100	Niobium Oxide	AVX
220	595D227X_004D2T	Tantalum	Vishay - Sprague
220	NOSD227M004R0100	Niobium Oxide	AVX
220	NOSE227M006R0100	Niobium Oxide	AVX

Applications Information (Continued)

SPLIT-RAIL OPERATION

The LM2852 can be powered using two separate voltages for AVIN and PVIN. AVIN is the supply for the control logic;

PVIN is the supply for the power FETs. The output filter components need to be chosen based on the value of PVIN. For PVIN levels lower than 3.3V, use output filter component values recommended for 3.3V. PVIN must always be equal to or less than AVIN.

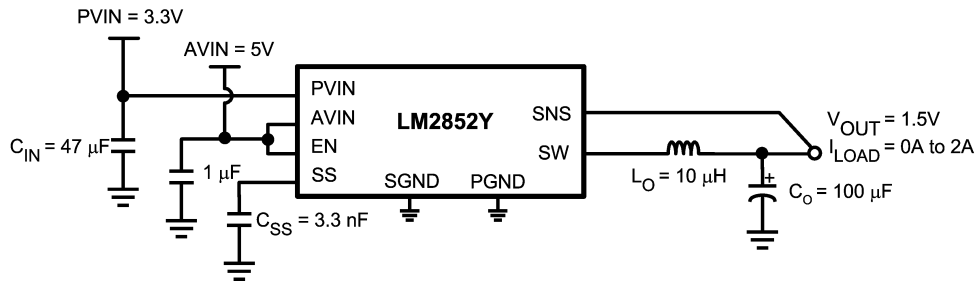

20127014

Layout Hints

These are several guidelines to follow while designing the PCB layout for an LM2852 application.

1. The input bulk capacitor, C_{IN} , should be placed very close to the PVIN pin to keep the resistance as low as possible between the capacitor and the pin. High current levels will be present in this connection.
2. All ground connections must be tied together. Use a broad ground plane, for example a completely filled back plane, to establish the lowest resistance possible between all ground connections.
3. The sense pin connection should be made as close to the load as possible so that the voltage at the load is the expected regulated value. The sense line should not run too close to nodes with high EMI (such as the switch node) to minimize interference.
4. The switch node connections should be low resistance to reduce power losses. Low resistance means the trace between the switch pin and the inductor should be wide. However, the area of the switch node should not be too large since EMI increases with greater area. So connect the inductor to the switch pin with a short, but wide trace. Other high current connections in the application such as PVIN and V_{OUT} assume the same trade off between low resistance and EMI.
5. Allow area under the chip to solder the entire exposed die attach pad to ground. Lab measurements show improved regulation performance when the exposed pad is well grounded.

LM2852Y Example Circuit Schematic (500kHz)

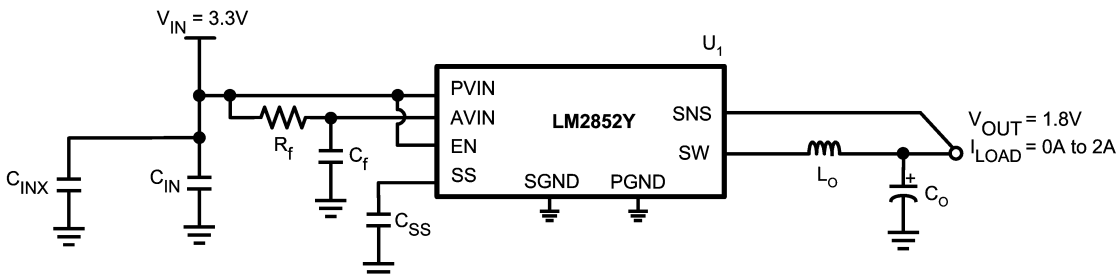

20127020

FIGURE 1.

Bill of Materials for 3.3V_{IN} to 1.8 V_{OUT} Conversion

ID	Part Number	Type	Size	Parameters	Qty	Vendor
U ₁	LM2852YMXA-1.8	2A Buck	ETSSOP-14		1	NSC
L _O	DO3316P-153	Inductor		15 µH	1	Coilcraft
C _O *	595D107X_6R3C2T	Capacitor	Case Code "C"	100 µF ±20%	1	Vishay-Sprague
C _{IN}	GRM32ER60J476ME20B	Capacitor	1210	47µF/X5R/6.3V	1	Murata
C _{INX}	GRM21BR71C105KA01B	Capacitor	0805	1µF/X7R/16V	1	Murata
C _{SS}	VJ0805Y272KXXA	Capacitor	0805	2.7nF ±10%	1	Vishay-Vitramon
R _f	CRCW060310R0F	Resistor	0603	10Ω ±10%	1	Vishay-Dale
C _f	GRM21BR71C105KA01B	Capacitor	0805	1µF/X7R/16V	1	Murata

* If a "non-tantalum" solution is desired use an NOSC107M004R0150, 100 µF capacitor from AVX for C_O.

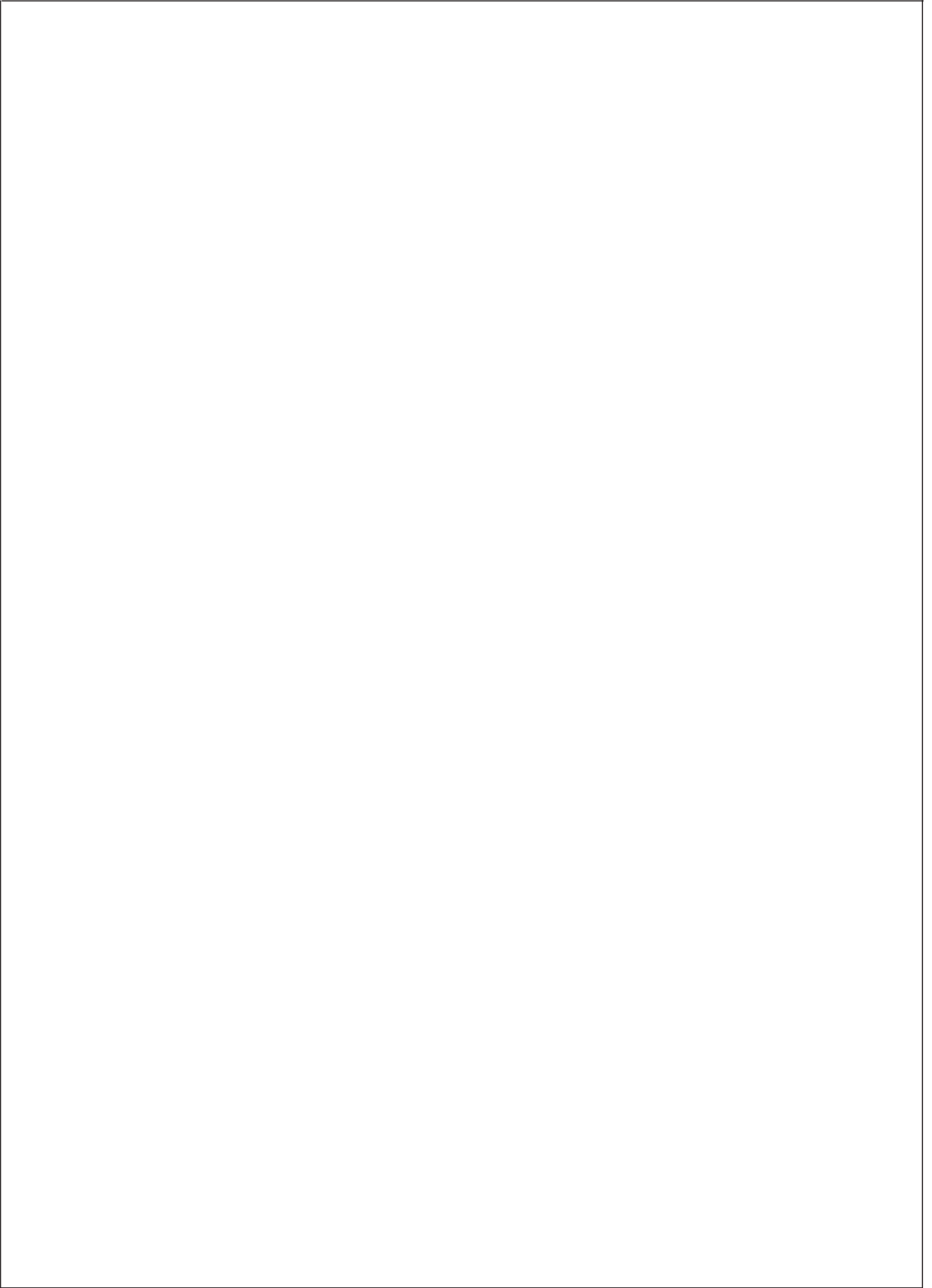

Physical Dimensions inches (millimeters)

unless otherwise noted

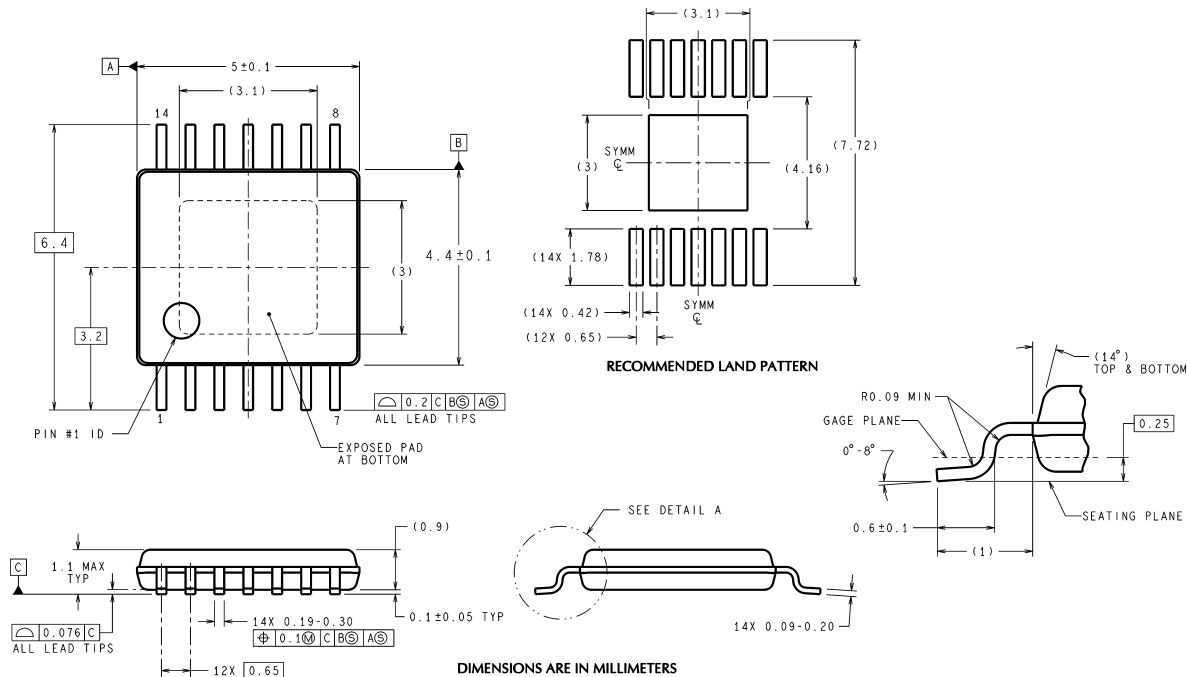

**14-Lead ETSSOP Package
NS Package Number MXA14A**

MXA14A (Rev A)

National does not assume any responsibility for use of any circuitry described, no circuit patent licenses are implied and National reserves the right at any time without notice to change said circuitry and specifications.

For the most current product information visit us at www.national.com.

LIFE SUPPORT POLICY

NATIONAL'S PRODUCTS ARE NOT AUTHORIZED FOR USE AS CRITICAL COMPONENTS IN LIFE SUPPORT DEVICES OR SYSTEMS WITHOUT THE EXPRESS WRITTEN APPROVAL OF THE PRESIDENT AND GENERAL COUNSEL OF NATIONAL SEMICONDUCTOR CORPORATION. As used herein:

1. Life support devices or systems are devices or systems which, (a) are intended for surgical implant into the body, or (b) support or sustain life, and whose failure to perform when properly used in accordance with instructions for use provided in the labeling, can be reasonably expected to result in a significant injury to the user.
2. A critical component is any component of a life support device or system whose failure to perform can be reasonably expected to cause the failure of the life support device or system, or to affect its safety or effectiveness.

BANNED SUBSTANCE COMPLIANCE

National Semiconductor certifies that the products and packing materials meet the provisions of the Customer Products Stewardship Specification (CSP-9-111C2) and the Banned Substances and Materials of Interest Specification (CSP-9-111S2) and contain no "Banned Substances" as defined in CSP-9-111S2.



National Semiconductor
Americas Customer
Support Center
Email: new.feedback@nsc.com
Tel: 1-800-272-9959

National Semiconductor
Europe Customer Support Center
Fax: +49 (0) 180-530 85 86
Email: europe.support@nsc.com
Deutsch Tel: +49 (0) 69 9508 6208
English Tel: +44 (0) 870 24 0 2171
Français Tel: +33 (0) 1 41 91 8790

National Semiconductor
Asia Pacific Customer
Support Center
Email: ap.support@nsc.com

National Semiconductor
Japan Customer Support Center
Fax: 81-3-5639-7507
Email: jpn.feedback@nsc.com
Tel: 81-3-5639-7560