

# LM611

## Operational Amplifier and Adjustable Reference

### General Description

The LM611 consists of a single-supply op-amp and a programmable voltage reference in one space saving 8-pin package. The op-amp out-performs most single-supply op-amps by providing higher speed and bandwidth along with low supply current. This device was specifically designed to lower cost and board space requirements in transducer, test, measurement and data acquisition systems.

Combining a stable voltage reference with a wide output swing op-amp makes the LM611 ideal for single supply transducers, signal conditioning and bridge driving where large common-mode signals are common. The voltage reference consists of a reliable band-gap design that maintains low dynamic output impedance ( $1\Omega$  typical), excellent initial tolerance (0.6%), and the ability to be programmed from 1.2V to 6.3V via two external resistors. The voltage reference is very stable even when driving large capacitive loads, as are commonly encountered in CMOS data acquisition systems.

As a member of National's Super-Block™ family, the LM611 is a space-saving monolithic alternative to a multi-chip solution, offering a high level of integration without sacrificing performance.

### Features

#### OP AMP

- Low operating current: 300  $\mu$ A (op amp)
- Wide supply voltage range: 4V to 36V
- Wide common-mode range:  $V^-$  to ( $V^+ - 1.8V$ )
- Wide differential input voltage:  $\pm 36V$
- Available in low cost 8-pin DIP
- Available in plastic package rated for Military Temperature Range Operation

#### REFERENCE

- Adjustable output voltage: 1.2V to 6.3V
- Tight initial tolerance available:  $\pm 0.6\%$
- Wide operating current range: 17  $\mu$ A to 20 mA
- Reference floats above ground
- Tolerant of load capacitance

### Applications

- Transducer bridge driver
- Process and Mass Flow Control systems
- Power supply voltage monitor
- Buffered voltage references for A/D's

### Connection Diagrams

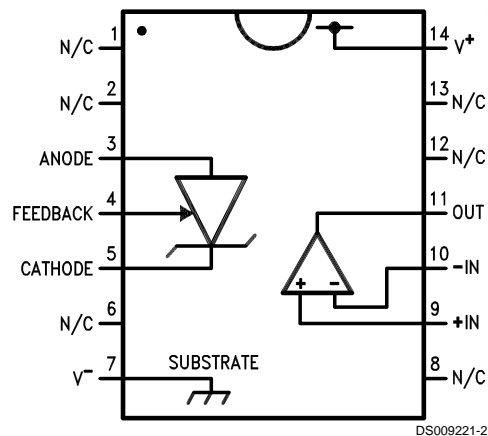
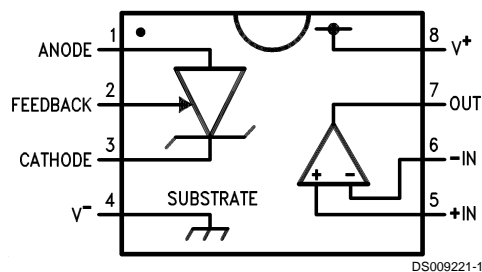

**Absolute Maximum Ratings** (Note 1)

If Military/Aerospace specified devices are required, please contact the National Semiconductor Sales Office/Distributors for availability and specifications.

Voltage on Any Pins Except $V_R$ (referred to $V^-$ pin) (Note 2)	36V (Max) -0.3V (Min)
Current through Any Input Pin and $V_R$ Pin	$\pm 20$ mA
Differential Input Voltage Military and Industrial Commercial	$\pm 36$ V $\pm 32$ V
Storage Temperature Range	$-65^\circ\text{C} \leq T_J \leq +150^\circ\text{C}$
Maximum Junction Temperature	$150^\circ\text{C}$

Thermal Resistance, Junction-to-Ambient (Note 3)

N Package	$100^\circ\text{C/W}$
M Package	$150^\circ\text{C/W}$
Soldering Information Soldering (10 seconds)	
N Package	$260^\circ\text{C}$
M Package	$220^\circ\text{C}$
ESD Tolerance (Note 4)	$\pm 1$ kV

**Operating Temperature Range**

LM611AI, LM611I, LM611BI	$-40^\circ\text{C} \leq T_J \leq +85^\circ\text{C}$
LM611AM, LM611M	$-55^\circ\text{C} \leq T_J \leq +125^\circ\text{C}$
LM611C	$0^\circ\text{C} \leq T_J \leq 70^\circ\text{C}$

**Electrical Characteristics**

These specifications apply for  $V^- = \text{GND} = 0\text{V}$ ,  $V^+ = 5\text{V}$ ,  $V_{\text{CM}} = V_{\text{OUT}} = 2.5\text{V}$ ,  $I_R = 100 \mu\text{A}$ , FEEDBACK pin shorted to GND, unless otherwise specified. Limits in standard typeface are for  $T_J = 25^\circ\text{C}$ ; limits in **boldface type** apply over the **Operating Temperature Range**.

Symbol	Parameter	Conditions	Typical (Note 5)	LM611AM LM611AI Limits (Note 6)	LM611M LM611BI LM611I LM611C Limits (Note 6)	Units
$I_S$	Total Supply Current	$R_{\text{LOAD}} = \infty$ , $4\text{V} \leq V^+ \leq 36\text{V}$ (32V for LM611C)	210	300	350	$\mu\text{A max}$
			<b>221</b>	<b>320</b>	<b>370</b>	$\mu\text{A max}$
$V_S$	Supply Voltage Range		2.2	2.8	2.8	V min
			<b>2.9</b>	<b>3</b>	<b>3</b>	V min
			46	36	32	V max
			<b>43</b>	<b>36</b>	<b>32</b>	V max
<b>OPERATIONAL AMPLIFIER</b>						
$V_{\text{OS1}}$	$V_{\text{OS}}$ Over Supply	$4\text{V} \leq V^+ \leq 36\text{V}$ ( $4\text{V} \leq V^+ \leq 32\text{V}$ for LM611C)	1.5	3.5	5.0	mV max
			<b>2.0</b>	<b>6.0</b>	<b>7.0</b>	mV max
$V_{\text{OS2}}$	$V_{\text{OS}}$ Over $V_{\text{CM}}$	$V_{\text{CM}} = 0\text{V}$ through $V_{\text{CM}} =$ ( $V^+ - 1.8\text{V}$ ), $V^+ = 30\text{V}$ , $V^- = 0\text{V}$	1.0	3.5	5.0	mV max
			<b>1.5</b>	<b>6.0</b>	<b>7.0</b>	mV max
$\frac{V_{\text{OS3}}}{\Delta T}$	Average $V_{\text{OS}}$ Drift	(Note 6)	<b>15</b>			$\mu\text{V}/^\circ\text{C}$ max
$I_B$	Input Bias Current		10	25	35	nA max
			<b>11</b>	<b>30</b>	<b>40</b>	nA max
$I_{\text{OS}}$	Input Offset Current		0.2	4	4	nA max
			<b>0.3</b>	<b>5</b>	<b>5</b>	nA max
$\frac{I_{\text{OS1}}}{\Delta T}$	Average Offset Drift Current		<b>4</b>			pA/ $^\circ\text{C}$
$R_{\text{IN}}$	Input Resistance	Differential	1800			M $\Omega$
		Common-Mode	3800			M $\Omega$
$C_{\text{IN}}$	Input Capacitance	Common-Mode	5.7			pF
$e_n$	Voltage Noise	$f = 100$ Hz, Input Referred	74			nV/ $\sqrt{\text{Hz}}$
$I_n$	Current Noise	$f = 100$ Hz, Input Referred	58			fA/ $\sqrt{\text{Hz}}$
CMRR	Common-Mode Rejection-Ratio	$V^+ = 30\text{V}$ , $0\text{V} \leq V_{\text{CM}} \leq (V^+ - 1.8\text{V})$	95	80	75	dB min
		CMRR = $20 \log (\Delta V_{\text{CM}}/\Delta V_{\text{OS}})$	<b>90</b>	<b>75</b>	<b>70</b>	dB min

## Electrical Characteristics (Continued)

These specifications apply for  $V^- = \text{GND} = 0\text{V}$ ,  $V^+ = 5\text{V}$ ,  $V_{\text{CM}} = V_{\text{OUT}} = 2.5\text{V}$ ,  $I_{\text{R}} = 100\ \mu\text{A}$ , FEEDBACK pin shorted to GND, unless otherwise specified. Limits in standard typeface are for  $T_{\text{J}} = 25^\circ\text{C}$ ; limits in **boldface type** apply over the **Operating Temperature Range**.

Symbol	Parameter	Conditions	Typical (Note 5)	LM611AM LM611AI Limits (Note 6)	LM611M LM611BI LM611I LM611C Limits (Note 6)	Units
<b>OPERATIONAL AMPLIFIER</b>						
PSRR	Power Supply Rejection-Ratio	$4\text{V} \leq V^+ \leq 30\text{V}$ , $V_{\text{CM}} = V^+/2$ , $\text{PSRR} = 20 \log (\Delta V^+/\Delta V_{\text{OS}})$	110 <b>100</b>	80 <b>75</b>	75 <b>70</b>	dB min dB min
$A_{\text{V}}$	Open Loop Voltage Gain	$R_{\text{L}} = 10\ \text{k}\Omega$ to GND, $V^+ = 30\text{V}$ , $5\text{V} \leq V_{\text{OUT}} \leq 25\text{V}$	500 <b>50</b>	100 <b>40</b>	94 <b>40</b>	V/mV min
SR	Slew Rate	$V^+ = 30\text{V}$ (Note 7)	0.70 <b>0.65</b>	0.55 <b>0.45</b>	0.50 <b>0.45</b>	V/ $\mu\text{s}$
GBW	Gain Bandwidth	$C_{\text{L}} = 50\ \text{pF}$	0.80 <b>0.50</b>			MHz
$V_{\text{O1}}$	Output Voltage Swing High	$R_{\text{L}} = 10\ \text{k}\Omega$ to GND $V^+ = 36\text{V}$ (32V for LM611C)	$V^+ - 1.4$ <b><math>V^+ - 1.6</math></b>	$V^+ - 1.7$ <b><math>V^+ - 1.9</math></b>	$V^+ - 1.8$ <b><math>V^+ - 1.9</math></b>	V min V min
$V_{\text{O2}}$	Output Voltage Swing Low	$R_{\text{L}} = 10\ \text{k}\Omega$ to $V^+$ $V^+ = 36\text{V}$ (32V for LM611C)	$V^- + 0.8$ <b><math>V^- + 0.9</math></b>	$V^- + 0.9$ <b><math>V^- + 1.0</math></b>	$V^- + 0.95$ <b><math>V^- + 1.0</math></b>	V max V max
$I_{\text{OUT}}$	Output Source Current	$V_{\text{OUT}} = 2.5\text{V}$ , $V_{+\text{IN}} = 0\text{V}$ , $V_{-\text{IN}} = -0.3\text{V}$	25 <b>15</b>	20 <b>13</b>	16 <b>13</b>	mA min mA min
$I_{\text{SINK}}$	Output Sink Current	$V_{\text{OUT}} = 1.6\text{V}$ , $V_{+\text{IN}} = 0\text{V}$ , $V_{-\text{IN}} = 0.3\text{V}$	17 <b>9</b>	14 <b>8</b>	13 <b>8</b>	mA min mA min
$I_{\text{SHORT}}$	Short Circuit Current	$V_{\text{OUT}} = 0\text{V}$ , $V_{+\text{IN}} = 3\text{V}$ , $V_{-\text{IN}} = 2\text{V}$ , Source	30 <b>40</b>	50 <b>60</b>	50 <b>60</b>	mA max mA max
		$V_{\text{OUT}} = 5\text{V}$ , $V_{+\text{IN}} = 2\text{V}$ , $V_{-\text{IN}} = 3\text{V}$ , Sink	30 <b>32</b>	60 <b>80</b>	70 <b>90</b>	mA max mA max
<b>VOLTAGE REFERENCE</b>						
$V_{\text{R}}$	Reference Voltage	(Note 8)	1.244	1.2365 1.2515 ( $\pm 0.6\%$ )	1.2191 1.2689 ( $\pm 2.0\%$ )	V min V max
$\frac{\Delta V_{\text{R}}}{\Delta T_{\text{J}}}$	Average Temperature Drift	(Note 9)	<b>10</b>	<b>80</b>	<b>150</b>	PPM/ $^\circ\text{C}$ max
$\frac{\Delta V_{\text{R}}}{\Delta T_{\text{J}}}$	Hysteresis	Hyst = $(V_{\text{ro}'} - V_{\text{ro}})/\Delta T_{\text{J}}$ (Note 10)	<b>3.2</b>			$\mu\text{V}/^\circ\text{C}$
$\frac{\Delta V_{\text{R}}}{\Delta I_{\text{R}}}$	$V_{\text{R}}$ Change with Current	$V_{\text{R}(100\ \mu\text{A})} - V_{\text{R}(17\ \mu\text{A})}$	0.05 <b>0.1</b>	1 <b>1.1</b>	1 <b>1.1</b>	mV max mV max
		$V_{\text{R}(10\ \text{mA})} - V_{\text{R}(100\ \mu\text{A})}$ (Note 11)	1.5 <b>2.0</b>	5 <b>5.5</b>	5 <b>5.5</b>	mV max mV max
R	Resistance	$\Delta V_{\text{R}(10 \rightarrow 0.1\ \text{mA})}/9.9\ \text{mA}$ $\Delta V_{\text{R}(100 \rightarrow 17\ \mu\text{A})}/83\ \mu\text{A}$	<b>0.2</b> <b>0.6</b>	<b>0.56</b> <b>13</b>	<b>0.56</b> <b>13</b>	$\Omega$ max $\Omega$ max
$\frac{\Delta V_{\text{R}}}{V_{\text{RO}}}$	$V_{\text{R}}$ Change with High $V_{\text{RO}}$	$V_{\text{R}(V_{\text{ro}} = V_{\text{r}})} - V_{\text{R}(V_{\text{ro}} = 6.3\text{V})}$ (5.06V between Anode and FEEDBACK)	2.5 <b>2.8</b>	7 <b>10</b>	7 <b>10</b>	mV max mV max
		$V_{\text{R}(V^+ = 5\text{V})} - V_{\text{R}(V^+ = 3\text{V})}$	0.1 <b>0.1</b>	1.2 <b>1.3</b>	1.2 <b>1.3</b>	mV max mV max
$\frac{\Delta V_{\text{R}}}{\Delta V^+}$	$V_{\text{R}}$ Change with $V^+$ Change	$V_{\text{R}(V^+ = 5\text{V})} - V_{\text{R}(V^+ = 3\text{V})}$	0.1 <b>0.1</b>	1.2 <b>1.3</b>	1.2 <b>1.3</b>	mV max mV max
		$V_{\text{R}(V^+ = 5\text{V})} - V_{\text{R}(V^+ = 3\text{V})}$	0.01 <b>0.01</b>	1 <b>1.5</b>	1 <b>1.5</b>	mV max mV max

## Electrical Characteristics (Continued)

These specifications apply for  $V^- = \text{GND} = 0\text{V}$ ,  $V^+ = 5\text{V}$ ,  $V_{\text{CM}} = V_{\text{OUT}} = 2.5\text{V}$ ,  $I_{\text{R}} = 100\ \mu\text{A}$ , FEEDBACK pin shorted to GND, unless otherwise specified. Limits in standard typeface are for  $T_{\text{J}} = 25^\circ\text{C}$ ; limits in **boldface type** apply over the **Operating Temperature Range**.

Symbol	Parameter	Conditions	Typical (Note 5)	LM611AM LM611AI Limits (Note 6)	LM611M LM611BI LM611I LM611C Limits (Note 6)	Units
<b>VOLTAGE REFERENCE</b>						
$\frac{\Delta V_{\text{R}}}{\Delta V_{\text{ANODE}}}$	$V_{\text{R}}$ Change with $V_{\text{ANODE}}$ Change	$V^+ = V^+ \text{ max}$ , $\Delta V_{\text{R}} = V_{\text{R}}$ (@ $V_{\text{ANODE}} = V^- = \text{GND}$ ) - $V_{\text{R}}$ (@ $V_{\text{ANODE}} = V^+ - 1.0\text{V}$ )	0.7 <b>3.3</b>	1.5 <b>3.0</b>	1.6 <b>3.0</b>	mV max mV max
$I_{\text{FB}}$	FEEDBACK Bias Current	$I_{\text{FB}}$ ; $V_{\text{ANODE}} \leq V_{\text{FB}} \leq 5.06\text{V}$	22 <b>29</b>	35 <b>40</b>	50 <b>55</b>	nA max nA max
$e_{\text{n}}$	$V_{\text{R}}$ Noise	10 Hz to 10,000 Hz, $V_{\text{RO}} = V_{\text{R}}$	30			$\mu\text{V}_{\text{RMS}}$

**Note 1:** Absolute maximum ratings indicate limits beyond which damage to the component may occur. Electrical specifications do not apply when operating the device beyond its rated operating conditions.

**Note 2:** More accurately, it is excessive current flow, with resulting excess heating, that limits the voltages on all pins. When any pin is pulled a diode drop below  $V^-$ , a parasitic NPN transistor turns ON. No latch-up will occur as long as the current through that pin remains below the Maximum Rating. Operation is undefined and unpredictable when any parasitic diode or transistor is conducting.

**Note 3:** Junction temperature may be calculated using  $T_{\text{J}} = T_{\text{A}} + P_{\text{D}} \theta_{\text{JA}}$ . The given thermal resistance is worst-case for packages in sockets in still air. For packages soldered to copper-clad board with dissipation from one op amp or reference output transistor, nominal  $\theta_{\text{JA}}$  is  $90^\circ\text{C}/\text{W}$  for the N package and  $135^\circ\text{C}/\text{W}$  for the M package.

**Note 4:** Human body model, 100 pF discharged through a 1.5 k $\Omega$  resistor.

**Note 5:** Typical values in standard typeface are for  $T_{\text{J}} = 25^\circ\text{C}$ ; values in **boldface type** apply for the full operating temperature range. These values represent the most likely parametric norm.

**Note 6:** All limits are guaranteed at room temperature (standard type face) or at operating temperature extremes (**bold face type**).

**Note 7:** Slew rate is measured with op amp in a voltage follower configuration. For rising slew rate, the input voltage is driven from 5V to 25V, and the output voltage transition is sampled at 10V and 20V. For falling slew rate, the input voltage is driven from 25V to 5V, and output voltage transition is sampled at 20V and 10V.

**Note 8:**  $V_{\text{R}}$  is the cathode-feedback voltage, nominally 1.244V.

**Note 9:** Average reference drift is calculated from the measurement of the reference voltage at  $25^\circ\text{C}$  and at the temperature extremes. The drift, in ppm/ $^\circ\text{C}$ , is  $10^6 \cdot \Delta V_{\text{R}} / (V_{\text{R}[25^\circ\text{C}]} \cdot \Delta T_{\text{J}})$ , where  $\Delta V_{\text{R}}$  is the lowest value subtracted from the highest,  $V_{\text{R}[25^\circ\text{C}]}$  is the value at  $25^\circ\text{C}$ , and  $\Delta T_{\text{J}}$  is the temperature range. This parameter is guaranteed by design and sample testing.

**Note 10:** Hysteresis is the change in  $V_{\text{R}}$  caused by a change in  $T_{\text{J}}$ , after the reference has been "dehysteresized". To dehysteresize the reference; that is minimize the hysteresis to the typical value, its junction temperature should be cycled in the following pattern, spiraling in toward  $25^\circ\text{C}$ :  $25^\circ\text{C}$ ,  $85^\circ\text{C}$ ,  $-40^\circ\text{C}$ ,  $70^\circ\text{C}$ ,  $0^\circ\text{C}$ ,  $25^\circ\text{C}$ .

**Note 11:** Low contact resistance is required for accurate measurement.

**Note 12:** Military RETS 611AMX electrical test specification is available on request. The LM611AMJ/883 can also be procured as a Standard Military Drawing.

## Typical Performance Characteristics (Reference) $T_{\text{J}} = 25^\circ\text{C}$ , FEEDBACK pin shorted to $V^- = 0\text{V}$ , unless otherwise noted

**Reference Voltage vs Temp on 5 Representative Units**

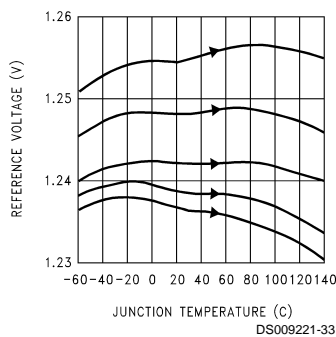

**Reference Voltage Drift**

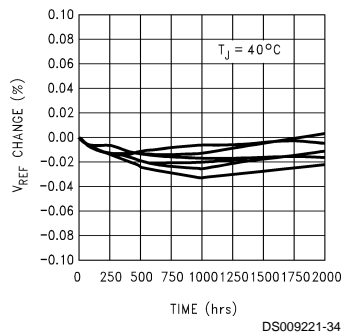

**Accelerated Reference Voltage Drift vs Time**

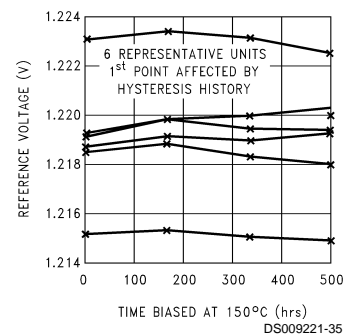

**Typical Performance Characteristics (Reference)**  $T_J = 25^\circ\text{C}$ , FEEDBACK pin shorted to  $V^- = 0\text{V}$ , unless otherwise noted (Continued)

**Reference Voltage vs Current and Temperature**

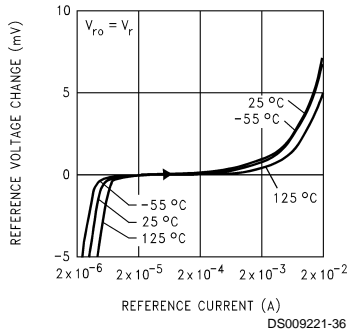

**Reference Voltage vs Current and Temperature**

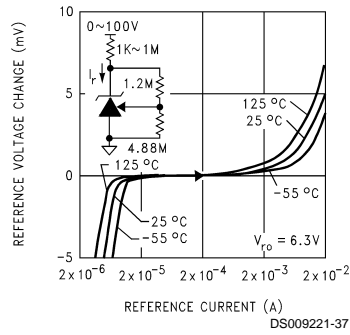

**Reference Voltage vs Reference Current**

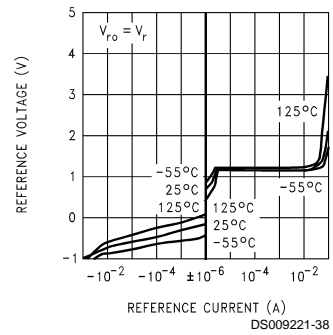

**Reference Voltage vs Reference Current**

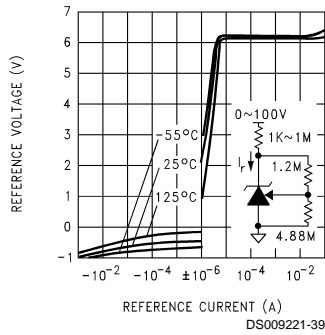

**Reference AC Stability Range**

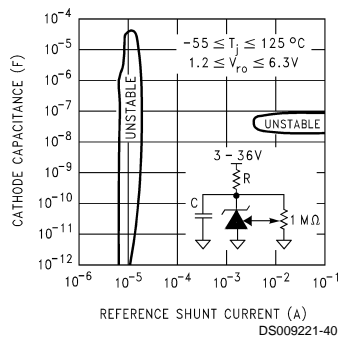

**Feedback Current vs Feedback-to-Anode Voltage**

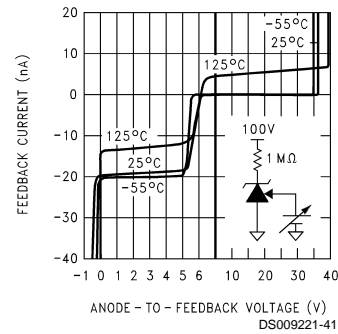

**Feedback Current vs Feedback-to-Anode Voltage**

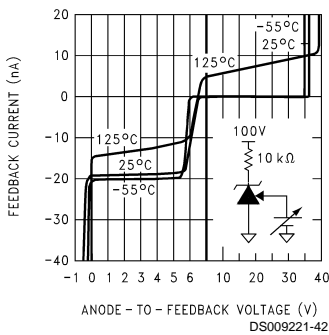

**Reference Noise Voltage vs Frequency**

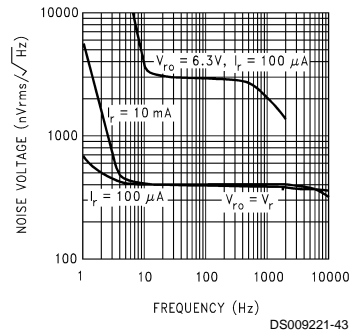

**Reference Small-Signal Resistance vs Frequency**

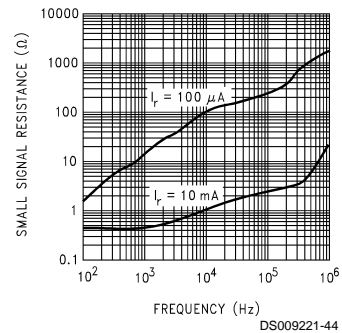

**Typical Performance Characteristics (Reference)**  $T_J = 25^\circ\text{C}$ , FEEDBACK pin shorted to  $V^- = 0\text{V}$ , unless otherwise noted (Continued)

**Reference Power-Up Time**

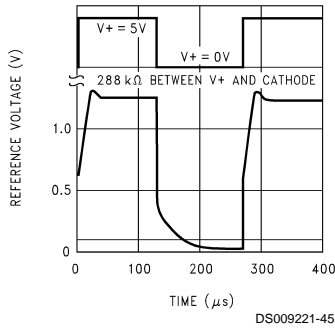

**Reference Voltage with Feedback Voltage Step**

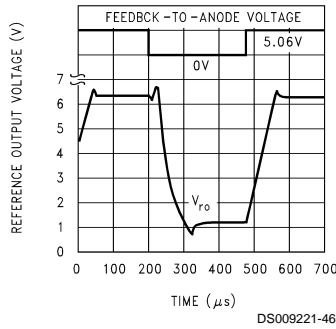

**Reference Voltage with 100–12 μA Current Step**

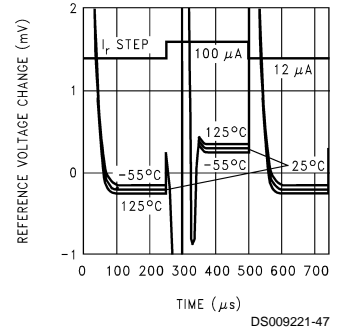

**Reference Step Response for 100 μA ~ 10 mA Current Step**

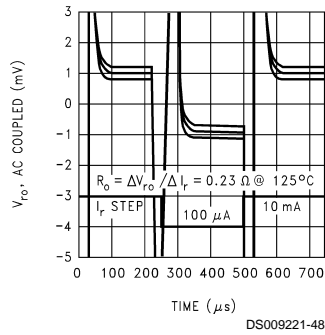

**Reference Voltage Change with Supply Voltage Step**

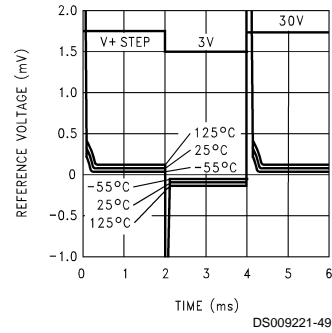

**Typical Performance Characteristics (Op Amps)**  $V^+ = 5\text{V}$ ,  $V^- = \text{GND} = 0\text{V}$ ,  $V_{\text{CM}} = V^+/2$ ,  $V_{\text{OUT}} = V^+/2$ ,  $T_J = 25^\circ\text{C}$ , unless otherwise noted

**Input Common-Mode Voltage Range vs Temperature**

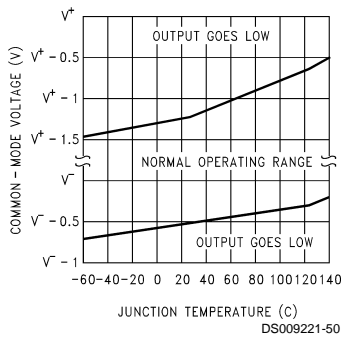

**Vos vs Junction Temperature**

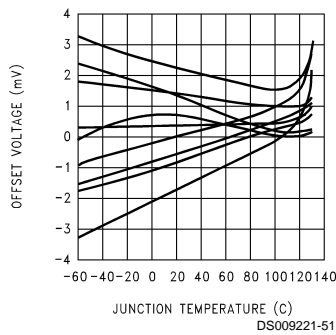

**Input Bias Current vs Common-Mode Voltage**

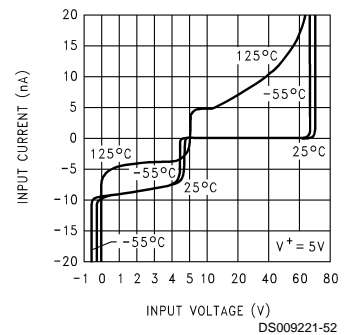

# Typical Performance Characteristics (Op Amps) $V^+ = 5V, V^- = GND = 0V, V_{CM} = V^+/2, V_{OUT} = V^+/2, T_J = 25^\circ C$ , unless otherwise noted (Continued)

## Reference Change vs Common-Mode Voltage

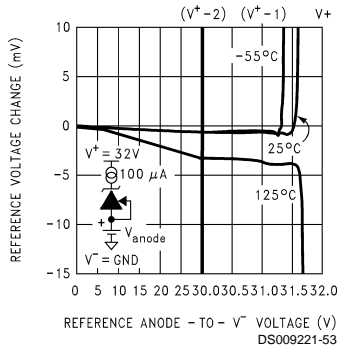

## Large-Signal Step Response

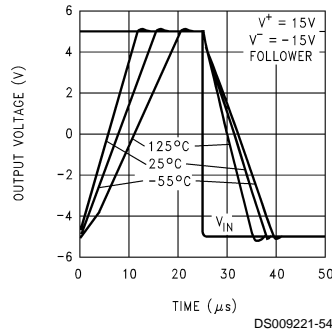

## Output Voltage Swing vs Temp. and Current

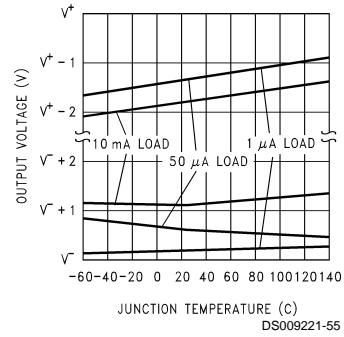

## Output Source Current vs Output Voltage and Temp.

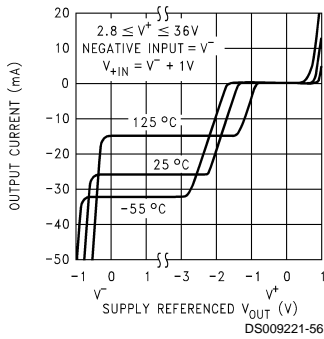

## Output Sink Current vs Output Voltage

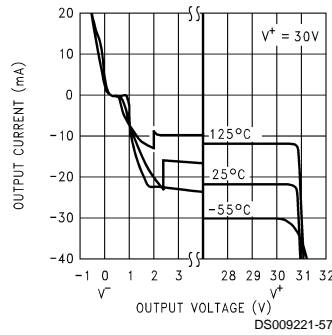

## Output Swing, Large Signal

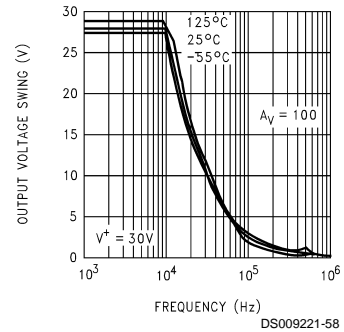

## Output Impedance vs Frequency and Gain

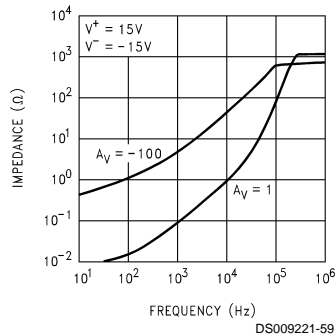

## Small Signal Pulse Response vs Temp.

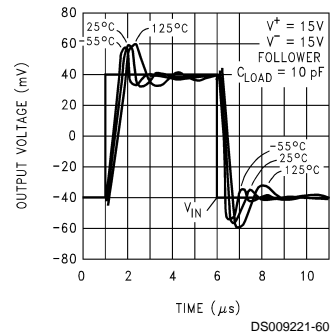

## Small-Signal Pulse Response vs Load

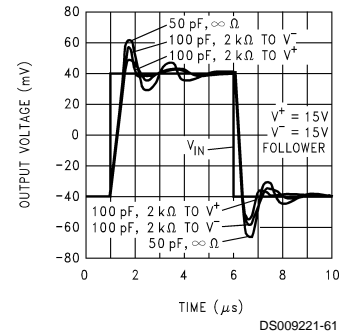

# Typical Performance Characteristics (Op Amps) $V^+ = 5V, V^- = GND = 0V, V_{CM} = V^+/2,$ $V_{OUT} = V^+/2, T_J = 25^\circ C,$ unless otherwise noted (Continued)

**Op Amp Voltage Noise vs Frequency**

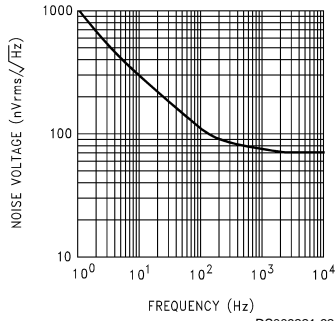

DS009221-62

**Op Amp Current Noise vs Frequency**

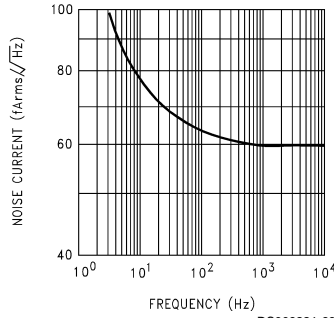

DS009221-63

**Small-Signal Voltage Gain vs Frequency and Temperature**

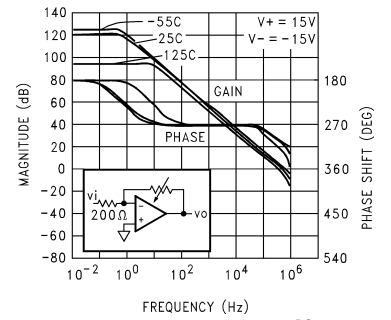

DS009221-64

**Small-Signal Voltage Gain vs Frequency and Load**

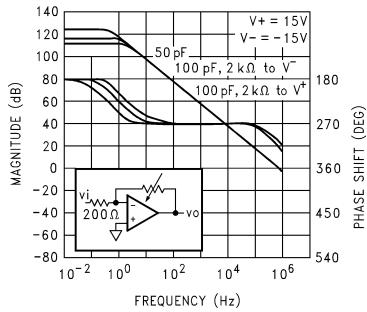

DS009221-65

**Follower Small-Signal Frequency Response**

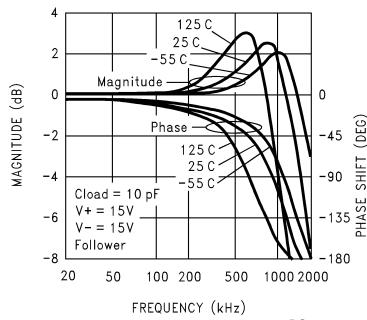

DS009221-66

**Common-Mode Input Voltage Rejection Ratio**

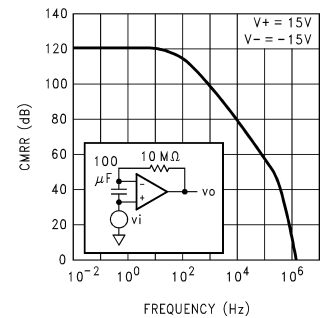

DS009221-67

**Power Supply Current vs Power Supply Voltage**

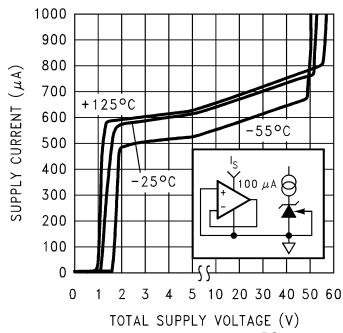

DS009221-68

**Positive Power Supply Voltage Rejection Ratio**

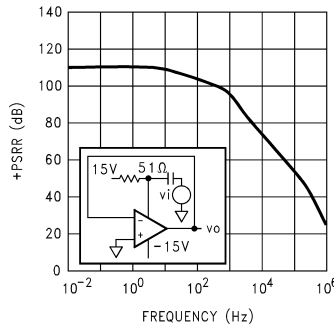

DS009221-69

**Negative Power Supply Voltage Rejection Ratio**

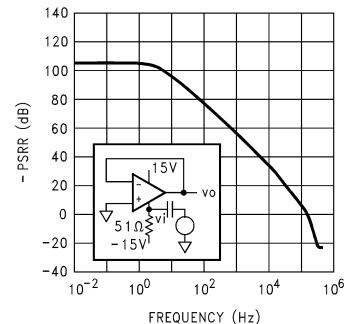

DS009221-70



# Typical Performance Characteristics (Op Amps) $V^+ = 5V, V^- = GND = 0V, V_{CM} = V^+/2,$ $V_{OUT} = V^+/2, T_J = 25^\circ C,$ unless otherwise noted (Continued)

**Slew Rate vs Temperature**

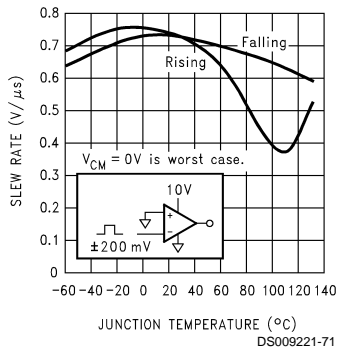

**Input Offset Current vs Junction Temperature**

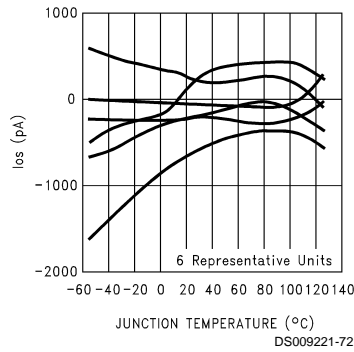

**Input Bias Current vs Junction Temperature**

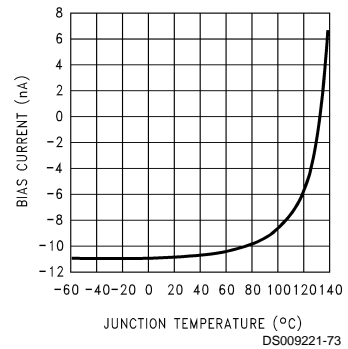

## Typical Performance Distributions

**Average  $V_{OS}$  Drift Military Temperature Range**

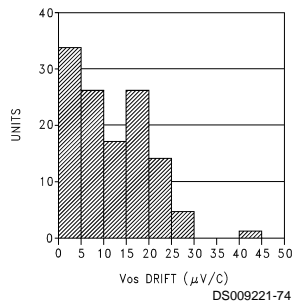

**Average  $V_{OS}$  Drift Industrial Temperature Range**

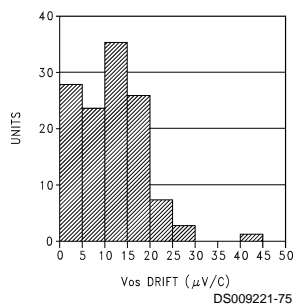

**Average  $V_{OS}$  Drift Commercial Temperature Range**

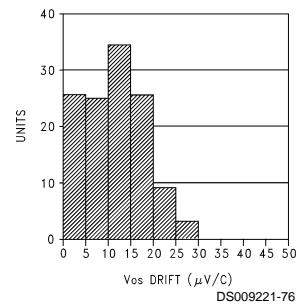

**Average  $I_{OS}$  Drift Military Temperature Range**

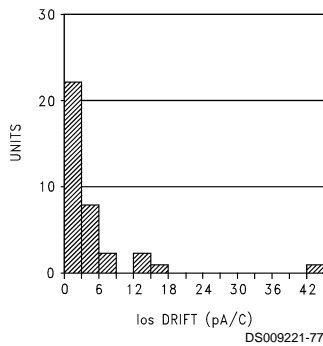

**Average  $I_{OS}$  Drift Industrial Temperature Range**

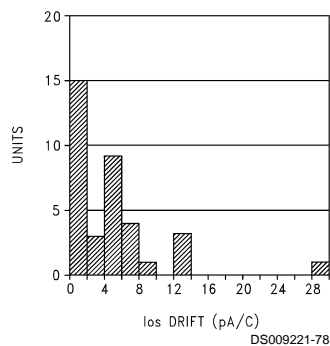

**Average  $I_{OS}$  Drift Commercial Temperature Range**

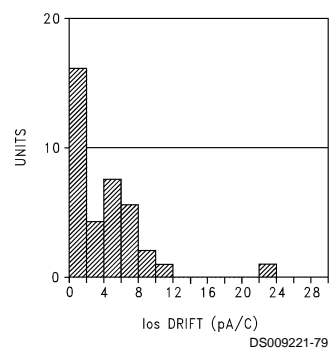

## Typical Performance Distributions (Continued)

**Voltage Reference Broad-Band Noise Distribution**

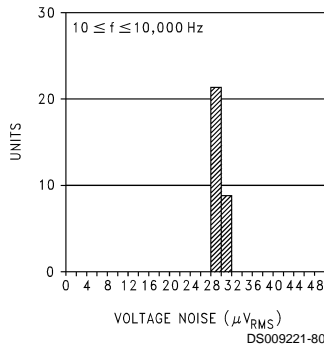

**Op Amp Voltage Noise Distribution**

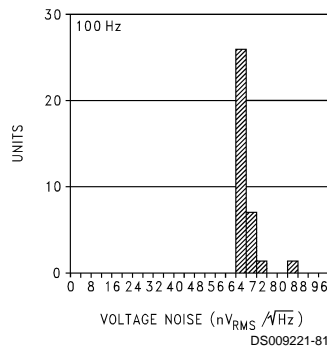

**Op Amp Current Noise Distribution**

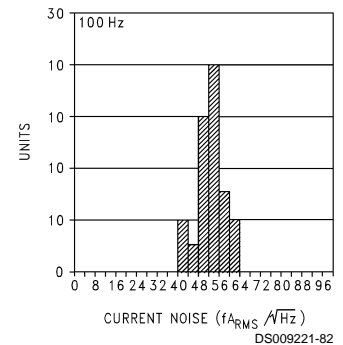

## Application Information

### VOLTAGE REFERENCE

#### Reference Biasing

The voltage reference is of a shunt regulator topology that models as a simple zener diode. With current  $I_r$  flowing in the 'forward' direction there is the familiar diode transfer function.  $I_r$  flowing in the reverse direction forces the reference voltage to be developed from cathode to anode. The applied voltage to the cathode may range from a diode drop below  $V^-$  to the reference voltage or to the avalanche voltage of the parallel protection diode, nominally 7V. A 6.3V reference with  $V^+ = 3V$  is allowed.

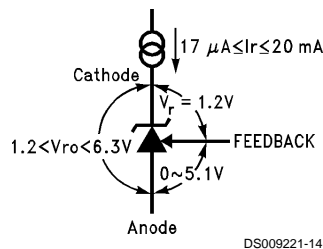

**FIGURE 1. Voltages Associated with Reference (Current Source  $I_r$  is External)**

The reference equivalent circuit reveals how  $V_r$  is held at the constant 1.2V by feedback, and how the FEEDBACK pin passes little current.

To generate the required reverse current, typically a resistor is connected from a supply voltage higher than the reference voltage. Varying that voltage, and so varying  $I_r$ , has small effect with the equivalent series resistance of less than an ohm at the higher currents. Alternatively, an active current source, such as the LM134 series, may generate  $I_r$ .

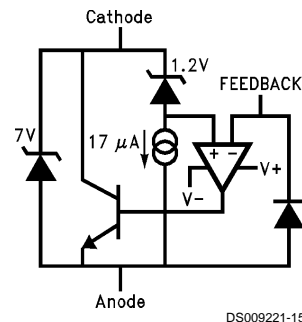

**FIGURE 2. Reference Equivalent Circuit**

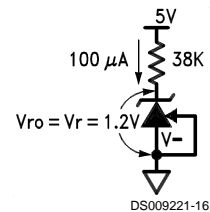

**FIGURE 3. 1.2V Reference**

Capacitors in parallel with the reference are allowed. See the Reference AC Stability Range curve for capacitance values—from 20  $\mu A$  to 3 mA any capacitor value is stable. With the reference's wide stability range with resistive and capacitive loads, a wide range of RC filter values will perform noise filtering.

#### Adjustable Reference

The FEEDBACK pin allows the reference output voltage,  $V_{ro}$ , to vary from 1.24V to 6.3V. The reference attempts to hold  $V_r$  at 1.24V. If  $V_r$  is above 1.24V, the reference will conduct current from Cathode to Anode; FEEDBACK current always remains low. If FEEDBACK is connected to Anode, then  $V_{ro} = V_r = 1.24V$ . For higher voltages FEEDBACK is held at a constant voltage above Anode—say 3.76V for  $V_{ro} = 5V$ . Connecting a resistor across the constant  $V_r$  generates a current  $I = R1/V_r$  flowing from Cathode into FEEDBACK node. A Thevenin equivalent 3.76V is generated from FEEDBACK to Anode with  $R2 = 3.76/I$ . Keep  $I$  greater than one thousand times larger than FEEDBACK bias current for

## Application Information (Continued)

<0.1% error —  $\geq 32 \mu\text{A}$  for the military grade over the military temperature range ( $\geq 5.5 \mu\text{A}$  for a 1% untrimmed error for a commercial part.)

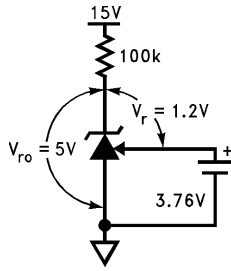

DS009221-17

**FIGURE 4. Thevenin Equivalent of Reference with 5V Output**

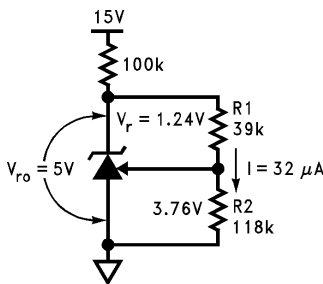

DS009221-18

$$R1 = Vr/I = 1.24/32\mu = 39k$$

$$R2 = R1 \{ (Vro/Vr) - 1 \} = 39k \{ (5/1.24) - 1 \} = 118k$$

**FIGURE 5. Resistors R1 and R2 Program Reference Output Voltage to be 5V**

Understanding that  $V_r$  is fixed and that voltage sources, resistors, and capacitors may be tied to the FEEDBACK pin, a range of  $V_r$  temperature coefficients may be synthesized.

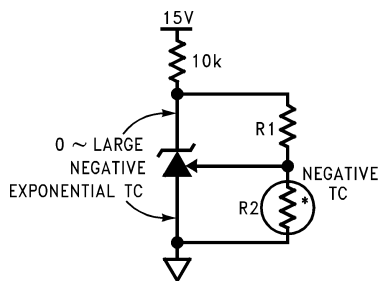

DS009221-19

**FIGURE 6. Output Voltage has Negative Temperature Coefficient (TC) if R2 has Negative TC**

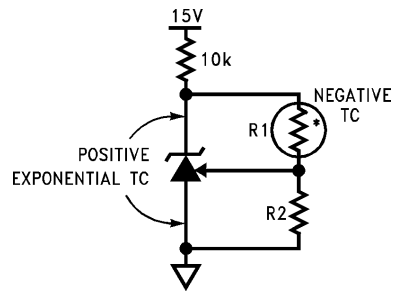

DS009221-20

**FIGURE 7. Output Voltage has Positive TC if R1 has Negative TC**

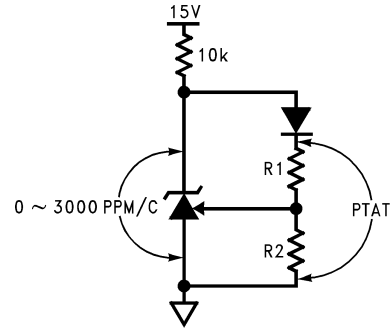

DS009221-21

**FIGURE 8. Diode in Series with R1 Causes Voltage Across R1 and R2 to be Proportional to Absolute Temperature (PTAT)**

Connecting a resistor across Cathode-to-FEEDBACK creates a 0 TC current source, but a range of TCs may be synthesized.

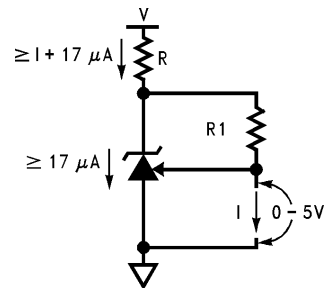

DS009221-22

$$I = Vr/R1 = 1.24/R1$$

**FIGURE 9. Current Source is Programmed by R1**

## Application Information (Continued)

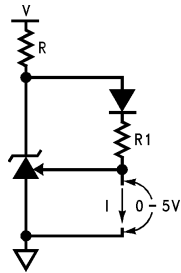

DS009221-23

**FIGURE 10. Proportional-to-Absolute-Temperature Current Source**

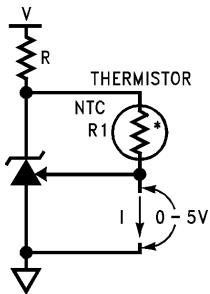

DS009221-24

**FIGURE 11. Negative -TC Current Source**

### Hysteresis

The reference voltage depends, slightly, on the thermal history of the die. Competitive micro-power products vary—always check the data sheet for any given device. Do not assume that no specification means no hysteresis.

### OPERATIONAL AMPLIFIER

The amp or the reference may be biased in any way with no effect on the other, except when a substrate diode conducts (see Guaranteed Electrical Characteristics Note 1). The amp may have inputs outside the common-mode range, may be operated as a comparator, or have all terminals floating with no effect on the reference (tying inverting input to output and non-inverting input to  $V^-$  on unused amp is preferred). Choosing operating points that cause oscillation, such as driving too large a capacitive load, is best avoided.

### Op Amp Output Stage

The op amp, like the LM124 series, has a flexible and relatively wide-swing output stage. There are simple rules to optimize output swing, reduce cross-over distortion, and optimize capacitive drive capability:

1. Output Swing: Unloaded, the 42  $\mu\text{A}$  pull-down will bring the output within 300 mV of  $V^-$  over the military temperature range. If more than 42  $\mu\text{A}$  is required, a resistor from output to  $V^-$  will help. Swing across any load may be im-

proved slightly if the load can be tied to  $V^+$ , at the cost of poorer sinking open-loop voltage gain.

2. Cross-over Distortion: The LM611 has lower cross-over distortion (a 1  $V_{BE}$  deadband versus 3  $V_{BE}$  for the LM124), and increased slew rate as shown in the characteristic curves. A resistor pull-up or pull-down will force class-A operation with only the PNP or NPN output transistor conducting, eliminating cross-over distortion.
3. Capacitive Drive: Limited by the output pole caused by the output resistance driving capacitive loads, a pull-down resistor conducting 1 mA or more reduces the output stage NPN  $r_e$  until the output resistance is that of the current limit 25 $\Omega$ . 200 pF may then be driven without oscillation.

### Op Amp Input Stage

The lateral PNP input transistors, unlike those of most op amps, have  $BV_{EBO}$  equal to the absolute maximum supply voltage. Also, they have no diode clamps to the positive supply nor across the inputs. These features make the inputs look like high impedances to input sources producing large differential and common-mode voltages.

## Typical Applications

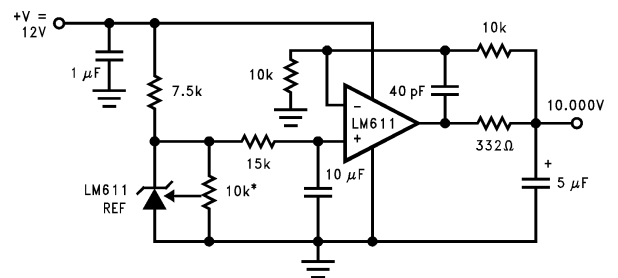

DS009221-28

\*10k must be low  
t.c. trim pot.

**FIGURE 12. Ultra Low Noise 10.000V Reference.**  
Total Output Noise is Typically 14  $\mu\text{V}_{RMS}$ .  
Adjust the 10k pot for 10.000V.

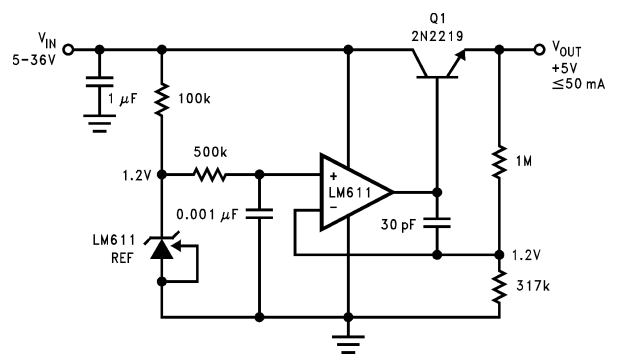

DS009221-30

**FIGURE 13. Simple Low Quiescent Drain Voltage Regulator.** Total Supply Current is approximately 320  $\mu\text{A}$  when  $V_{IN} = 5\text{V}$ , and output has no load.

## Typical Applications (Continued)

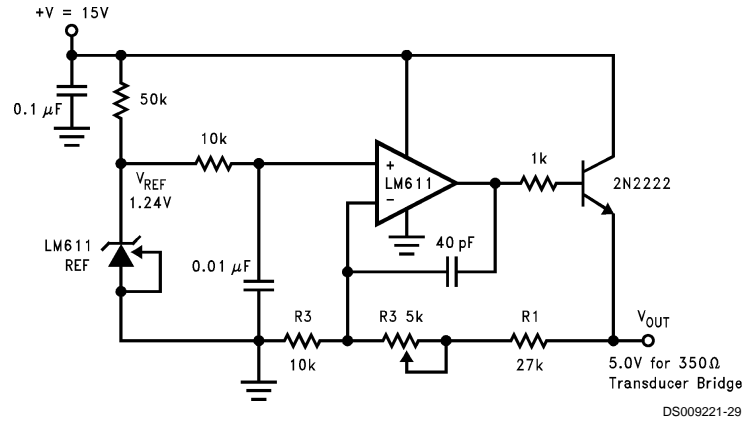

$V_{OUT} = (R1/R2 + 1) V_{REF}$ .  
 R1, R2 should be 1% metal film.  
 R3 should be low t.c. trim pot.

**FIGURE 14. Slow Rise-Time Upon Power-Up,  
 Adjustable Transducer Bridge Driver.**  
 Rise-time is approximately 0.5 ms.

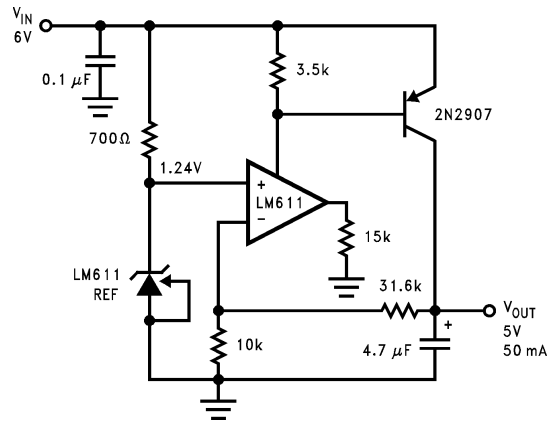

DS009221-31

**FIGURE 15. Low Drop-Out Voltage Regulator Circuit.** Drop out voltage is typically 0.2V.

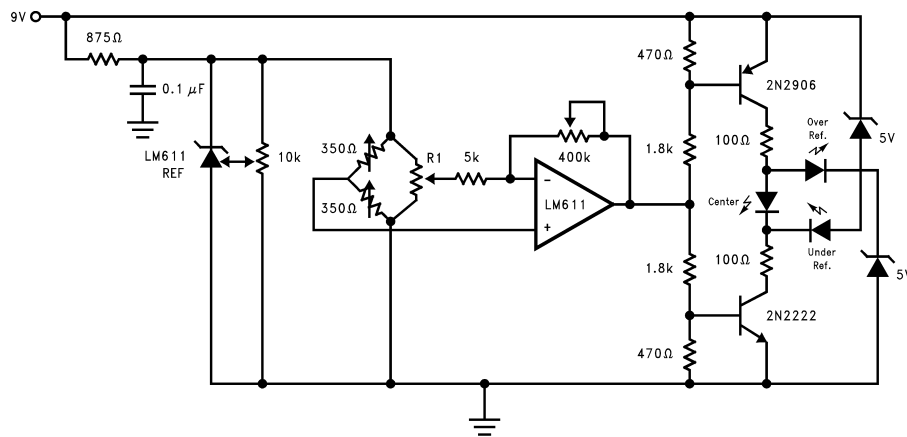

DS009221-32

**FIGURE 16. Nulling Bridge Detection System.** Adjust sensitivity via 400 kΩ pot.  
 Null offset with R1, and bridge drive with the 10k pot.

## Simplified Schematic Diagrams

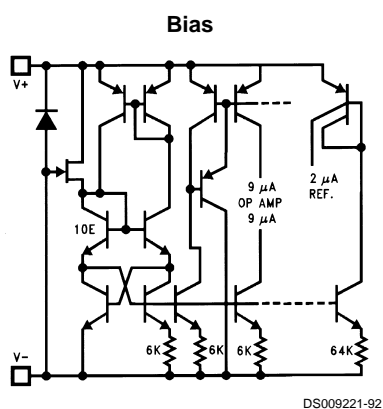
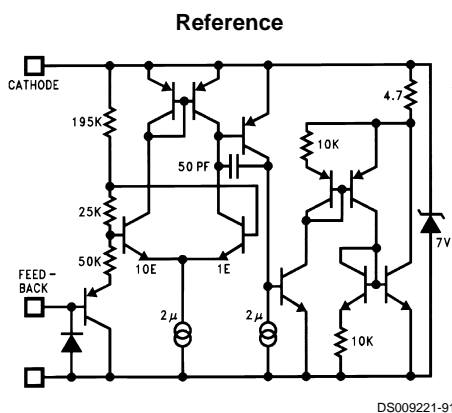
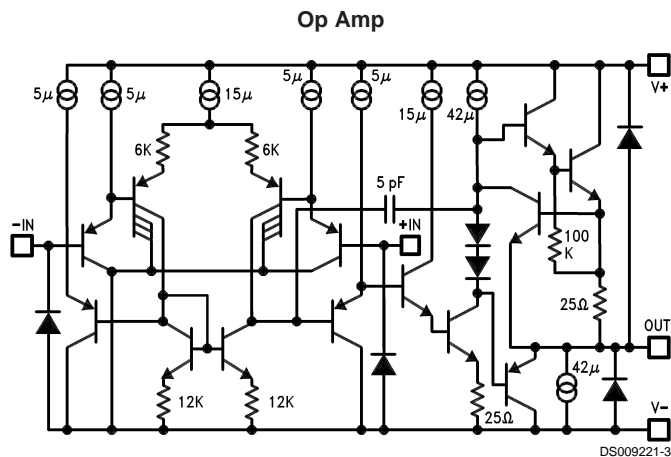

## Ordering Information

Reference Tolerance & V <sub>OS</sub>	Temperature Range			Package	NSC Drawing
	Military -55°C ≤ T <sub>A</sub> ≤ +125°C	Industrial -40°C ≤ T <sub>A</sub> ≤ +85°C	Commercial 0°C ≤ T <sub>A</sub> ≤ +70°C		
±0.6% @ 80 ppm/°C max V <sub>OS</sub> = 3.5 mV max	LM611AMJ/883 (Note 12)	—	—	8-pin ceramic DIP	J08A
±2.0% @ 150 ppm/°C max V <sub>OS</sub> = 5 mV max	—	LM611IM LM611IMX	LM611CM LM611CMX	14-pin Narrow Surface Mount	M14A

**Physical Dimensions** inches (millimeters) unless otherwise noted

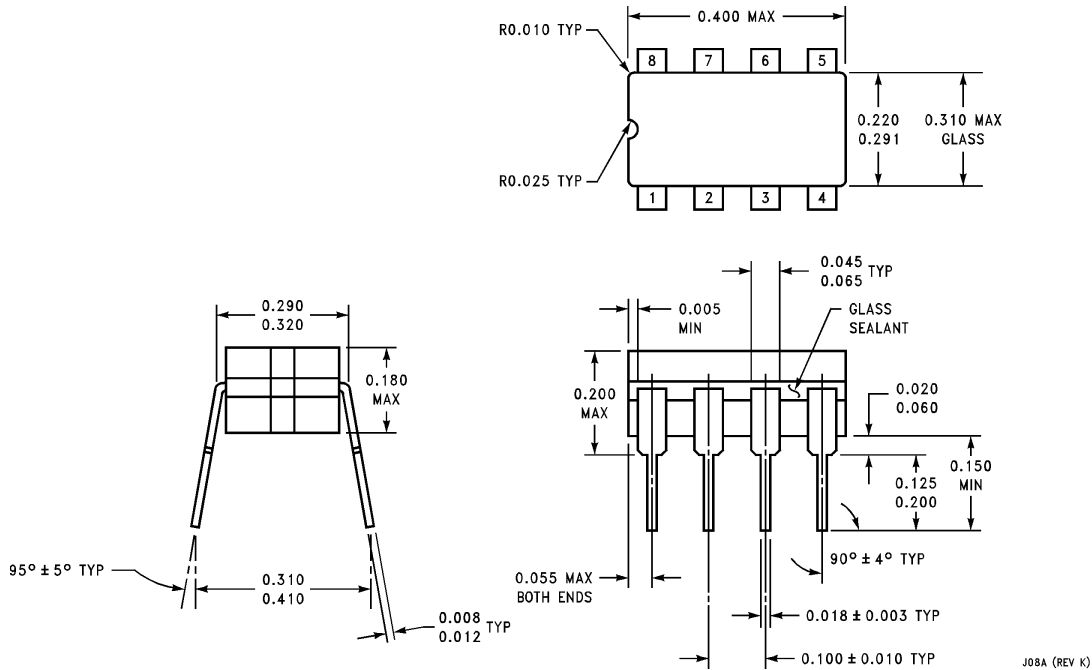

**Hermetic Dual-In-Line Package (J)**  
**Order Number LM611AMJ/883**  
**NS Package Number J08A**

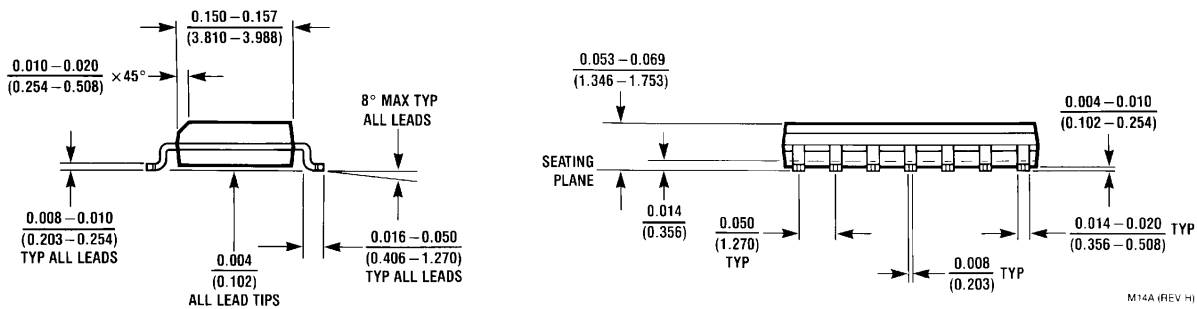
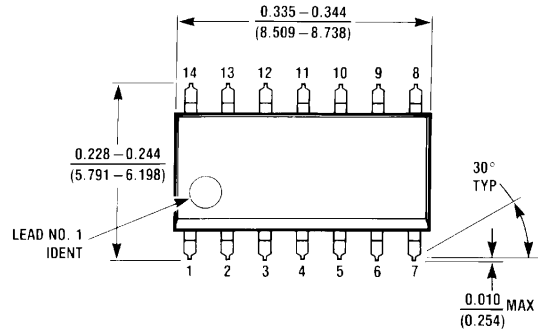

**Plastic Surface Mount Narrow Package (0.15) (M)**  
**Order Number LM611CM, LM611CMX, LM611IM or LM611IMX**  
**NS Package Number M14A**

Notes

**LIFE SUPPORT POLICY**

NATIONAL'S PRODUCTS ARE NOT AUTHORIZED FOR USE AS CRITICAL COMPONENTS IN LIFE SUPPORT DEVICES OR SYSTEMS WITHOUT THE EXPRESS WRITTEN APPROVAL OF THE PRESIDENT AND GENERAL COUNSEL OF NATIONAL SEMICONDUCTOR CORPORATION. As used herein:

1. Life support devices or systems are devices or systems which, (a) are intended for surgical implant into the body, or (b) support or sustain life, and whose failure to perform when properly used in accordance with instructions for use provided in the labeling, can be reasonably expected to result in a significant injury to the user.
2. A critical component is any component of a life support device or system whose failure to perform can be reasonably expected to cause the failure of the life support device or system, or to affect its safety or effectiveness.



**National Semiconductor Corporation**  
Americas  
Tel: 1-800-272-9959  
Fax: 1-800-737-7018  
Email: support@nsc.com  
www.national.com

**National Semiconductor Europe**  
Fax: +49 (0) 180-530 85 86  
Email: europe.support@nsc.com  
Deutsch Tel: +49 (0) 69 9508 6208  
English Tel: +44 (0) 870 24 0 2171  
Français Tel: +33 (0) 1 41 91 8790

**National Semiconductor Asia Pacific Customer Response Group**  
Tel: 65-2544466  
Fax: 65-2504466  
Email: ap.support@nsc.com

**National Semiconductor Japan Ltd.**  
Tel: 81-3-5639-7560  
Fax: 81-3-5639-7507