

LMC6462 Dual/LMC6464 Quad Micropower, Rail-to-Rail Input and Output CMOS Operational Amplifier

General Description

The LMC6462/4 is a micropower version of the popular LMC6482/4, combining Rail-to-Rail Input and Output Range with very low power consumption.

The LMC6462/4 provides an input common-mode voltage range that exceeds both rails. The rail-to-rail output swing of the amplifier, guaranteed for loads down to 25 k Ω , assures maximum dynamic signal range. This rail-to-rail performance of the amplifier, combined with its high voltage gain makes it unique among rail-to-rail amplifiers. The LMC6462/4 is an excellent upgrade for circuits using limited common-mode range amplifiers.

The LMC6462/4, with guaranteed specifications at 3V and 5V, is especially well-suited for low voltage applications. A quiescent power consumption of 60 μ W per amplifier (at $V_S = 3V$) can extend the useful life of battery operated systems. The amplifier's 150 fA input current, low offset voltage of 0.25 mV, and 85 dB CMRR maintain accuracy in battery-powered systems.

Features

(Typical unless otherwise noted)

- Ultra Low Supply Current 20 μ A/Amplifier
- Guaranteed Characteristics at 3V and 5V
- Rail-to-Rail Input Common-Mode Voltage Range
- Rail-to-Rail Output Swing
(within 10 mV of rail, $V_S = 5V$ and $R_L = 25 k\Omega$)
- Low Input Current 150 fA
- Low Input Offset Voltage 0.25 mV

Applications

- Battery Operated Circuits
- Transducer Interface Circuits
- Portable Communication Devices
- Medical Applications
- Battery Monitoring

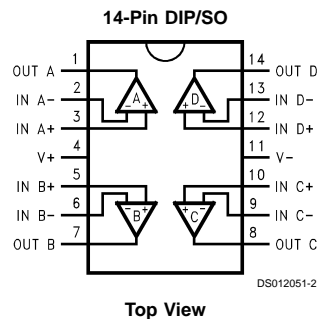
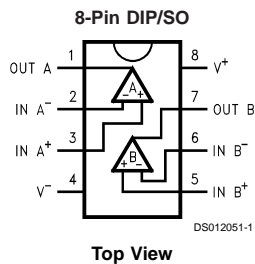

Ordering Information

Package	Temperature Range		NSC Drawing	Transport Media
	Military -55°C to +125°C	Industrial -40°C to +85°C		
8-Pin Molded DIP	LMC6462AMN	LMC6462AIN, LMC6462BIN	N08E	Rails
8-Pin SO-8		LMC6462AIM, LMC6462BIM LMC6462AIMX, LMC6462BIMX	M08A M08A	Rails Tape and Reel
14-Pin Molded DIP	LMC6464AMN	LMC6464AIN, LMC6464BIN	N14A	Rails
14-Pin SO-14		LMC6464AIM, LMC6464BIM LMC6464AIMX, LMC6464BIMX	M14A M14A	Rails Tape and Reel
8-Pin Ceramic DIP	LMC6462AMJ-QML		J08A	Rails
14-Pin Ceramic DIP	LMC6464AMJ-QML		J14A	Rails
14-Pin Ceramic SOIC	LMC6464AMWG-QML		WG14A	Trays

Absolute Maximum Ratings (Note 1)

If Military/Aerospace specified devices are required, please contact the National Semiconductor Sales Office/Distributors for availability and specifications.

ESD Tolerance (Note 2)	2.0 kV
Differential Input Voltage	±Supply Voltage
Voltage at Input/Output Pin	(V ⁺) + 0.3V, (V ⁻) - 0.3V
Supply Voltage (V ⁺ - V ⁻)	16V
Current at Input Pin (Note 12)	±5 mA
Current at Output Pin	
(Notes 3, 8)	±30 mA
Current at Power Supply Pin	40 mA
Lead Temp. (Soldering, 10 sec.)	260°C
Storage Temperature Range	-65°C to +150°C
Junction Temperature (Note 4)	150°C

Operating Ratings (Note 1)

Supply Voltage	3.0V ≤ V ⁺ ≤ 15.5V
Junction Temperature Range	
LMC6462AM, LMC6464AM	-55°C ≤ T _J ≤ +125°C
LMC6462AI, LMC6464AI	-40°C ≤ T _J ≤ +85°C
LMC6462BI, LMC6464BI	-40°C ≤ T _J ≤ +85°C
Thermal Resistance (θ _{JA})	
N Package, 8-Pin Molded DIP	115°C/W
M Package, 8-Pin Surface Mount	193°C/W
N Package, 14-Pin Molded DIP	81°C/W
M Package, 14-Pin Surface Mount	126°C/W

5V DC Electrical Characteristics

Unless otherwise specified, all limits guaranteed for T_J = 25°C, V⁺ = 5V, V⁻ = 0V, V_{CM} = V_O = V⁺/2 and R_L > 1M. **Boldface** limits apply at the temperature extremes.

Symbol	Parameter	Conditions	Typ (Note 5)	LMC6462AI	LMC6462BI	LMC6462AM	Units
				LMC6464AI Limit (Note 6)	LMC6464BI Limit (Note 6)	LMC6464AM Limit (Note 6)	
V _{OS}	Input Offset Voltage		0.25	0.5 1.2	3.0 3.7	0.5 1.5	mV max
TCV _{OS}	Input Offset Voltage Average Drift		1.5				µV/°C
I _B	Input Current	(Note 13)	0.15	10	10	200	pA max
I _{OS}	Input Offset Current	(Note 13)	0.075	5	5	100	pA max
C _{IN}	Common-Mode Input Capacitance		3				pF
R _{IN}	Input Resistance		>10				Tera Ω
CMRR	Common Mode Rejection Ratio	0V ≤ V _{CM} ≤ 15.0V, V ⁺ = 15V	85	70 67	65 62	70 65	dB min
		0V ≤ V _{CM} ≤ 5.0V V ⁺ = 5V	85	70 67	65 62	70 65	
+PSRR	Positive Power Supply Rejection Ratio	5V ≤ V ⁺ ≤ 15V, V ⁻ = 0V, V _O = 2.5V	85	70 67	65 62	70 65	dB min
-PSRR	Negative Power Supply Rejection Ratio	-5V ≤ V ⁻ ≤ -15V, V ⁺ = 0V, V _O = -2.5V	85	70 67	65 62	70 65	dB min
V _{CM}	Input Common-Mode Voltage Range	V ⁺ = 5V For CMRR ≥ 50 dB	-0.2	-0.10 0.00	-0.10 0.00	-0.10 0.00	V max
			5.30	5.25 5.00	5.25 5.00	5.25 5.00	V min
		V ⁺ = 15V For CMRR ≥ 50 dB	-0.2	-0.15 0.00	-0.15 0.00	-0.15 0.00	V max
			15.30	15.25 15.00	15.25 15.00	15.25 15.00	V min

5V DC Electrical Characteristics (Continued)

Unless otherwise specified, all limits guaranteed for $T_J = 25^\circ\text{C}$, $V^+ = 5\text{V}$, $V^- = 0\text{V}$, $V_{\text{CM}} = V_O = V^+/2$ and $R_L > 1\text{M}$. **Boldface** limits apply at the temperature extremes.

Symbol	Parameter	Conditions	Typ (Note 5)	LMC6462AI	LMC6462BI	LMC6462AM	Units		
				LMC6464AI Limit (Note 6)	LMC6464BI Limit (Note 6)	LMC6464AM Limit (Note 6)			
A_V	Large Signal Voltage Gain	$R_L = 100\text{ k}\Omega$ (Note 7)	Sourcing	3000			V/mV min		
			Sinking	400			V/mV min		
		$R_L = 25\text{ k}\Omega$ (Note 7)	Sourcing	2500			V/mV min		
			Sinking	200			V/mV min		
V_O	Output Swing	$V^+ = 5\text{V}$ $R_L = 100\text{ k}\Omega$ to $V^+/2$		4.995	4.990	4.950	4.990	V min	
				0.005	0.010	0.050	0.010	V max	
		$V^+ = 5\text{V}$ $R_L = 25\text{ k}\Omega$ to $V^+/2$		4.990	4.975	4.950	4.975	V min	
				0.010	0.020	0.050	0.020	V max	
		$V^+ = 15\text{V}$ $R_L = 100\text{ k}\Omega$ to $V^+/2$		14.990	14.975	14.950	14.975	V min	
				0.010	0.025	0.050	0.025	V max	
		$V^+ = 15\text{V}$ $R_L = 25\text{ k}\Omega$ to $V^+/2$		14.965	14.900	14.850	14.900	V min	
				0.025	0.050	0.100	0.050	V max	
		I_{SC}	Output Short Circuit Current $V^+ = 5\text{V}$	Sourcing, $V_O = 0\text{V}$	27	19	19	19	mA min
				Sinking, $V_O = 5\text{V}$	27	22	22	22	mA min
		I_{SC}	Output Short Circuit Current $V^+ = 15\text{V}$	Sourcing, $V_O = 0\text{V}$	38	24	24	24	mA min
				Sinking, $V_O = 12\text{V}$ (Note 8)	75	55	55	55	mA min
I_S	Supply Current	Dual, LMC6462 $V^+ = +5\text{V}$, $V_O = V^+/2$	40	55	55	55	μA max		
		Quad, LMC6464 $V^+ = +5\text{V}$, $V_O = V^+/2$	80	110	110	110	μA max		
		Dual, LMC6462 $V^+ = +15\text{V}$, $V_O = V^+/2$	50	60	60	60	μA max		
		Quad, LMC6464 $V^+ = +15\text{V}$, $V_O = V^+/2$	90	120	120	120	μA max		

5V AC Electrical Characteristics

Unless otherwise specified, all limits guaranteed for $T_J = 25^\circ\text{C}$, $V^+ = 5\text{V}$, $V^- = 0\text{V}$, $V_{\text{CM}} = V_O = V^+/2$ and $R_L > 1\text{M}$. **Boldface** limits apply at the temperature extremes.

Symbol	Parameter	Conditions	Typ (Note 5)	LMC6462AI LMC6464AI Limit (Note 6)	LMC6462BI LMC6464BI Limit (Note 6)	LMC6462AM LMC6464AM Limit (Note 6)	Units
SR	Slew Rate	(Note 9)	28	15 8	15 8	15 8	V/ms min
GBW	Gain-Bandwidth Product	$V^+ = 15\text{V}$	50				kHz
ϕ_m	Phase Margin		50				Deg
G_m	Gain Margin		15				dB
	Amp-to-Amp Isolation	(Note 10)	130				dB
e_n	Input-Referred Voltage Noise	$f = 1\text{ kHz}$ $V_{\text{CM}} = 1\text{V}$	80				$\text{nV}/\sqrt{\text{Hz}}$
i_n	Input-Referred Current Noise	$f = 1\text{ kHz}$	0.03				$\text{pA}/\sqrt{\text{Hz}}$

3V DC Electrical Characteristics

Unless otherwise specified, all limits guaranteed for $T_J = 25^\circ\text{C}$, $V^+ = 3\text{V}$, $V^- = 0\text{V}$, $V_{\text{CM}} = V_O = V^+/2$ and $R_L > 1\text{M}$. **Boldface** limits apply at the temperature extremes.

Symbol	Parameter	Conditions	Typ (Note 5)	LMC6462AI LMC6464AI Limit (Note 6)	LMC6462BI LMC6464BI Limit (Note 6)	LMC6462AM LMC6464AM Limit (Note 6)	Units
V_{OS}	Input Offset Voltage		0.9	2.0 2.7	3.0 3.7	2.0 3.0	mV max
TCV_{OS}	Input Offset Voltage Average Drift		2.0				$\mu\text{V}/^\circ\text{C}$
I_B	Input Current	(Note 13)	0.15	10	10	200	pA
I_{OS}	Input Offset Current	(Note 13)	0.075	5	5	100	pA
CMRR	Common Mode Rejection Ratio	$0\text{V} \leq V_{\text{CM}} \leq 3\text{V}$	74	60	60	60	dB min
PSRR	Power Supply Rejection Ratio	$3\text{V} \leq V^+ \leq 15\text{V}$, $V^- = 0\text{V}$	80	60	60	60	dB min
V_{CM}	Input Common-Mode Voltage Range	For CMRR $\geq 50\text{ dB}$	-0.10	0.0	0.0	0.0	V max
			3.0	3.0	3.0	3.0	V min
V_O	Output Swing	$R_L = 25\text{ k}\Omega$ to $V^+/2$	2.95	2.9	2.9	2.9	V min
			0.15	0.1	0.1	0.1	V max
I_S	Supply Current	Dual, LMC6462 $V_O = V^+/2$	40	55 70	55 70	55 70	μA
		Quad, LMC6464 $V_O = V^+/2$	80	110 140	110 140	110 140	μA max

3V AC Electrical Characteristics

Unless otherwise specified, $V^+ = 3V$, $V^- = 0V$, $V_{CM} = V_O = V^+/2$ and $R_L > 1M$. **Boldface limits** apply at the temperature extremes.

Symbol	Parameter	Conditions	Typ (Note 5)	LMC6462AI	LMC6462BI	LMC6462AM	Units
				LMC6464AI Limit (Note 6)	LMC6464BI Limit (Note 6)	LMC6464AM Limit (Note 6)	
SR	Slew Rate	(Note 11)	23				V/ms
GBW	Gain-Bandwidth Product		50				kHz

Note 1: Absolute Maximum Ratings indicate limits beyond which damage to the device may occur. Operating Ratings indicate conditions for which the device is intended to be functional, but specific performance is not guaranteed. For guaranteed specifications and the test conditions, see the Electrical Characteristics.

Note 2: Human body model, 1.5 k Ω in series with 100 pF. All pins rated per method 3015.6 of MIL-STD-883. This is a class 2 device rating.

Note 3: Applies to both single supply and split-supply operation. Continuous short circuit operation at elevated ambient temperature can result in exceeding the maximum allowed junction temperature of 150°C. Output currents in excess of ± 30 mA over long term may adversely affect reliability.

Note 4: The maximum power dissipation is a function of $T_{J(max)}$, θ_{JA} , and T_A . The maximum allowable power dissipation at any ambient temperature is $P_D = (T_{J(max)} - T_A)/\theta_{JA}$. All numbers apply for packages soldered directly into a PC board.

Note 5: Typical Values represent the most likely parametric norm.

Note 6: All limits are guaranteed by testing or statistical analysis.

Note 7: $V^+ = 15V$, $V_{CM} = 7.5V$ and R_L connected to 7.5V. For Sourcing tests, $7.5V \leq V_O \leq 11.5V$. For Sinking tests, $3.5V \leq V_O \leq 7.5V$.

Note 8: Do not short circuit output to V^+ , when V^+ is greater than 13V or reliability will be adversely affected.

Note 9: $V^+ = 15V$. Connected as Voltage Follower with 10V step input. Number specified is the slower of either the positive or negative slew rates.

Note 10: Input referred, $V^+ = 15V$ and $R_L = 100$ k Ω connected to 7.5V. Each amp excited in turn with 1 kHz to produce $V_O = 12$ V_{PP}.

Note 11: Connected as Voltage Follower with 2V step input. Number specified is the slower of either the positive or negative slew rates.

Note 12: Limiting input pin current is only necessary for input voltages that exceed absolute maximum input voltage ratings.

Note 13: Guaranteed limits are dictated by tester limitations and not device performance. Actual performance is reflected in the typical value.

Note 14: For guaranteed Military Temperature Range parameters see RETSMC6462/4X.

Typical Performance Characteristics $V_S = +5V$, Single Supply, $T_A = 25^\circ C$ unless otherwise specified

Supply Current vs Supply Voltage

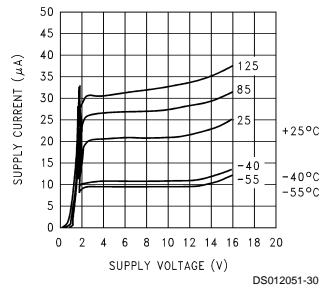

Sourcing Current vs Output Voltage

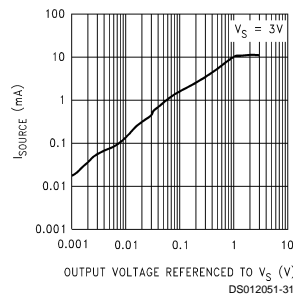

Sourcing Current vs Output Voltage

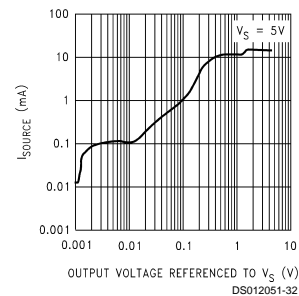

Sourcing Current vs Output Voltage

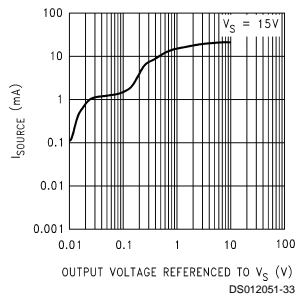

Sinking Current vs Output Voltage

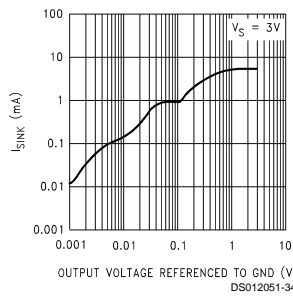

Sinking Current vs Output Voltage

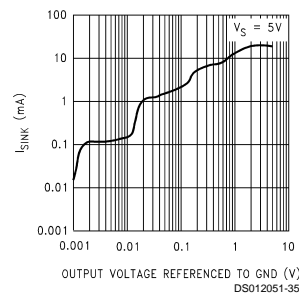

Typical Performance Characteristics $V_S = +5V$, Single Supply, $T_A = 25^\circ C$ unless otherwise specified (Continued)

Sinking Current vs Output Voltage

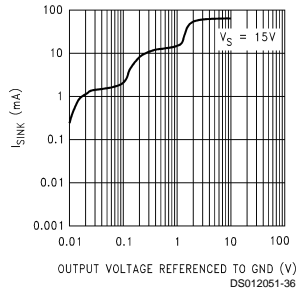

Input Voltage Noise vs Frequency

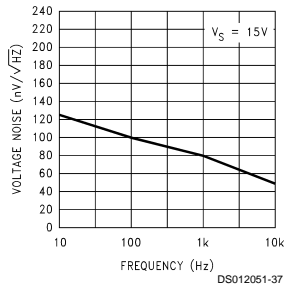

Input Voltage Noise vs Input Voltage

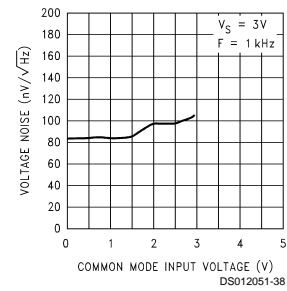

Input Voltage Noise vs Input Voltage

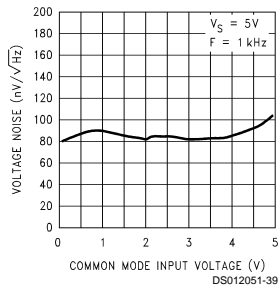

Input Voltage Noise vs Input Voltage

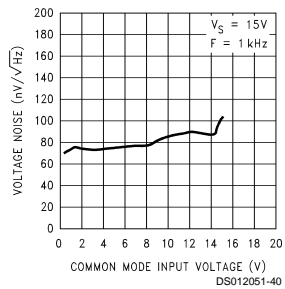

ΔV_{OS} vs CMR

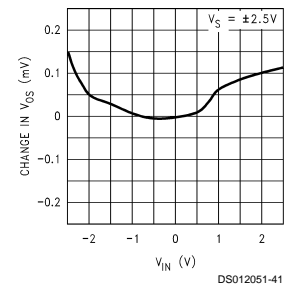

Input Voltage vs Output Voltage

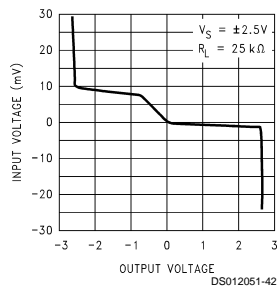

Open Loop Frequency Response

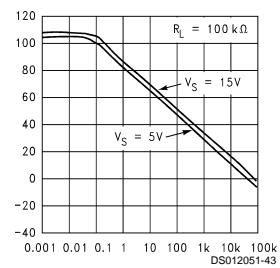

Open Loop Frequency Response vs Temperature

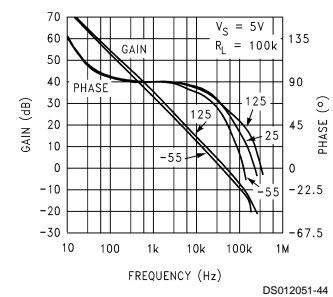

Typical Performance Characteristics $V_S = +5V$, Single Supply, $T_A = 25^\circ C$ unless otherwise specified (Continued)

Gain and Phase vs Capacitive Load

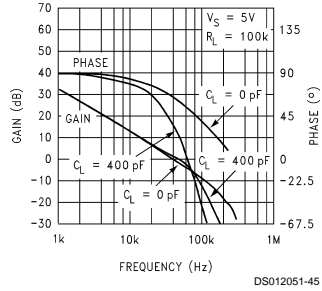

Slew Rate vs Supply Voltage

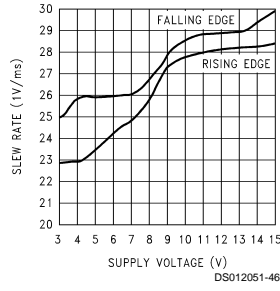

Non-Inverting Large Signal Pulse Response

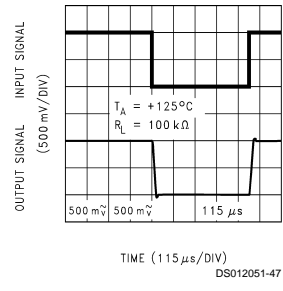

Non-Inverting Large Signal Pulse Response

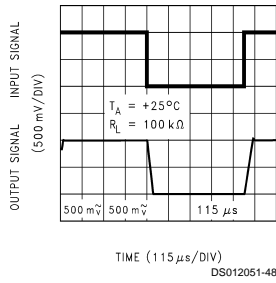

Non-Inverting Large Signal Pulse Response

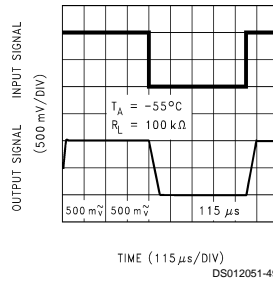

Non-Inverting Small Signal Pulse Response

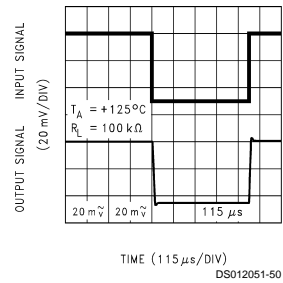

Non-Inverting Small Signal Pulse Response

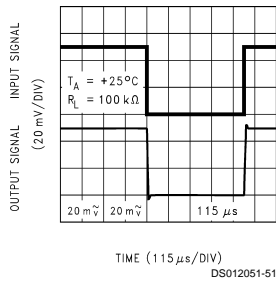

Non-Inverting Small Signal Pulse Response

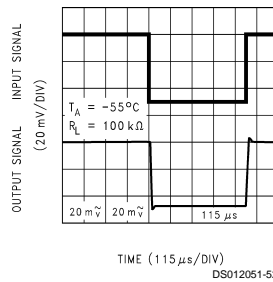

Inverting Large Signal Pulse Response

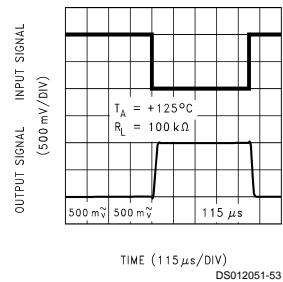

Typical Performance Characteristics $V_S = +5V$, Single Supply, $T_A = 25^\circ C$ unless otherwise specified (Continued)

Inverting Large Signal Pulse Response

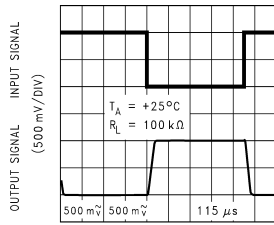

TIME (115 μs/DIV)
DS012051-54

Inverting Large Signal Pulse Response

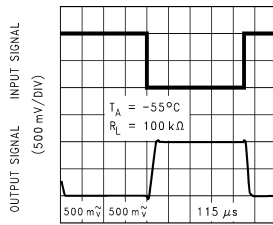

TIME (115 μs/DIV)
DS012051-55

Inverting Small Signal Pulse Response

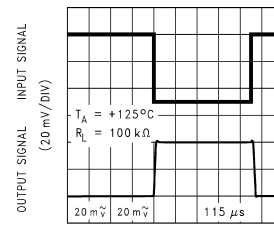

TIME (115 μs/DIV)
DS012051-56

Inverting Small Signal Pulse Response

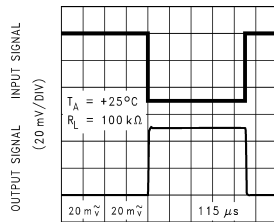

TIME (115 μs/DIV)
DS012051-57

Inverting Small Signal Pulse Response

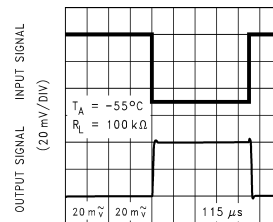

TIME (115 μs/DIV)
DS012051-58

Application Information

1.0 Input Common-Mode Voltage Range

The LMC6462/4 has a rail-to-rail input common-mode voltage range. *Figure 1* shows an input voltage exceeding both supplies with no resulting phase inversion on the output.

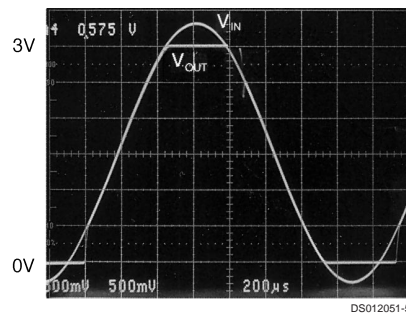

FIGURE 1. An Input Voltage Signal Exceeds the LMC6462/4 Power Supply Voltage with No Output Phase Inversion

The absolute maximum input voltage at $V^+ = 3V$ is 300 mV beyond either supply rail at room temperature. Voltages greatly exceeding this absolute maximum rating, as in *Figure 2*, can cause excessive current to flow in or out of the input

pins, possibly affecting reliability. The input current can be externally limited to ± 5 mA, with an input resistor, as shown in *Figure 3*.

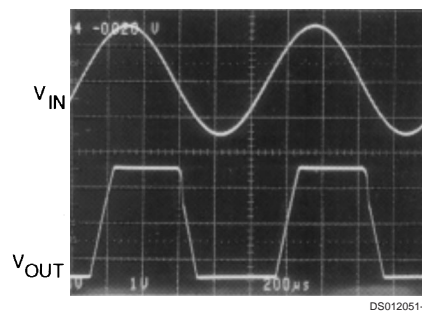

FIGURE 2. A $\pm 7.5V$ Input Signal Greatly Exceeds the 3V Supply in *Figure 3* Causing No Phase Inversion Due to R_I

Application Information (Continued)

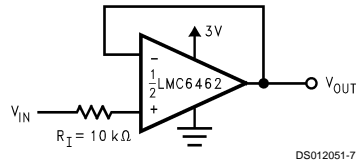

FIGURE 3. Input Current Protection for Voltages Exceeding the Supply Voltage

2.0 Rail-to-Rail Output

The approximated output resistance of the LMC6462/4 is 180Ω sourcing, and 130Ω sinking at $V_S = 3V$, and 110Ω sourcing and 83Ω sinking at $V_S = 5V$. The maximum output swing can be estimated as a function of load using the calculated output resistance.

3.0 Capacitive Load Tolerance

The LMC6462/4 can typically drive a 200 pF load with $V_S = 5V$ at unity gain without oscillating. The unity gain follower is the most sensitive configuration to capacitive load. Direct capacitive loading reduces the phase margin of op-amps. The combination of the op-amp's output impedance and the capacitive load induces phase lag. This results in either an underdamped pulse response or oscillation.

Capacitive load compensation can be accomplished using resistive isolation as shown in *Figure 4*. If there is a resistive component of the load in parallel to the capacitive component, the isolation resistor and the resistive load create a voltage divider at the output. This introduces a DC error at the output.

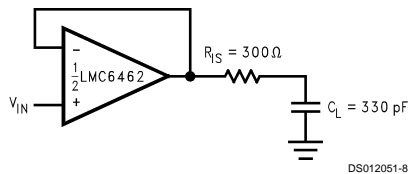

FIGURE 4. Resistive Isolation of a 300 pF Capacitive Load

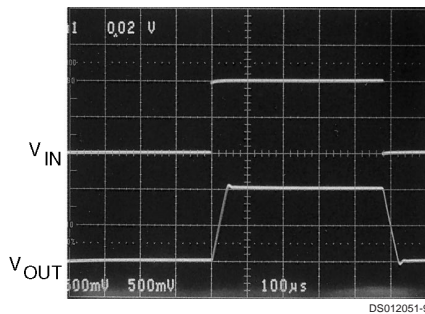

FIGURE 5. Pulse Response of the LMC6462 Circuit Shown in *Figure 4*

Figure 5 displays the pulse response of the LMC6462/4 circuit in *Figure 4*.

Another circuit, shown in *Figure 6*, is also used to indirectly drive capacitive loads. This circuit is an improvement to the circuit shown in *Figure 4* because it provides DC accuracy as well as AC stability. R_1 and C_1 serve to counteract the loss of phase margin by feeding the high frequency component of the output signal back to the amplifier's inverting input, thereby preserving phase margin in the overall feedback loop. The values of R_1 and C_1 should be experimentally determined by the system designer for the desired pulse response. Increased capacitive drive is possible by increasing the value of the capacitor in the feedback loop.

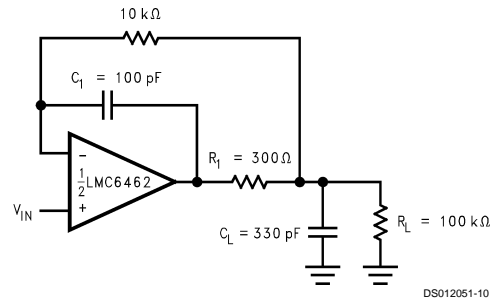

FIGURE 6. LMC6462 Non-Inverting Amplifier, Compensated to Handle a 300 pF Capacitive and $100\text{ k}\Omega$ Resistive Load

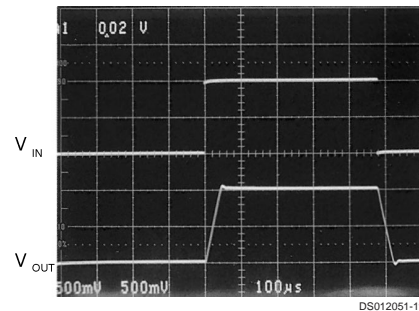

FIGURE 7. Pulse Response of LMC6462 Circuit in *Figure 6*

The pulse response of the circuit shown in *Figure 6* is shown in *Figure 7*.

4.0 Compensating for Input Capacitance

It is quite common to use large values of feedback resistance with amplifiers that have ultra-low input current, like the LMC6462/4. Large feedback resistors can react with small values of input capacitance due to transducers, photodiodes, and circuit board parasitics to reduce phase margins.

Application Information (Continued)

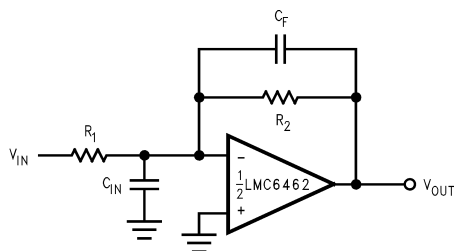

DS012051-12

FIGURE 8. Canceling the Effect of Input Capacitance

The effect of input capacitance can be compensated for by adding a feedback capacitor. The feedback capacitor (as in Figure 8), C_F , is first estimated by:

$$\frac{1}{2\pi R_1 C_{IN}} \geq \frac{1}{2\pi R_2 C_F}$$

or

$$R_1 C_{IN} \leq R_2 C_F$$

which typically provides significant overcompensation.

Printed circuit board stray capacitance may be larger or smaller than that of a breadboard, so the actual optimum value for C_F may be different. The values of C_F should be checked on the actual circuit. (Refer to the LMC660 quad CMOS amplifier data sheet for a more detailed discussion.)

5.0 Offset Voltage Adjustment

Offset voltage adjustment circuits are illustrated in Figure 9 and Figure 10. Large value resistances and potentiometers are used to reduce power consumption while providing typically ± 2.5 mV of adjustment range, referred to the input, for both configurations with $V_S = \pm 5$ V.

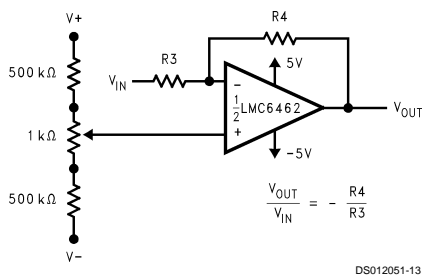

DS012051-13

FIGURE 9. Inverting Configuration Offset Voltage Adjustment

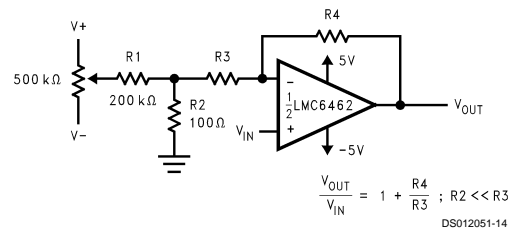

$$\frac{V_{OUT}}{V_{IN}} = 1 + \frac{R_4}{R_3}; R_2 \ll R_3$$

DS012051-14

FIGURE 10. Non-Inverting Configuration Offset Voltage Adjustment

6.0 Spice Macromodel

A Spice macromodel is available for the LMC6462/4. This model includes a simulation of:

- Input common-mode voltage range
- Frequency and transient response
- GBW dependence on loading conditions
- Quiescent and dynamic supply current
- Output swing dependence on loading conditions

and many more characteristics as listed on the macromodel disk.

Contact the National Semiconductor Customer Response Center to obtain an operational amplifier Spice model library disk.

7.0 Printed-Circuit-Board Layout for High-Impedance Work

It is generally recognized that any circuit which must operate with less than 1000 pA of leakage current requires special layout of the PC board. When one wishes to take advantage of the ultra-low input current of the LMC6462/4, typically 150 fA, it is essential to have an excellent layout. Fortunately, the techniques of obtaining low leakages are quite simple. First, the user must not ignore the surface leakage of the PC board, even though it may sometimes appear acceptably low, because under conditions of high humidity or dust or contamination, the surface leakage will be appreciable.

To minimize the effect of any surface leakage, lay out a ring of foil completely surrounding the LMC6462's inputs and the terminals of capacitors, diodes, conductors, resistors, relay terminals, etc. connected to the op-amp's inputs, as in Figure 11. To have a significant effect, guard rings should be placed in both the top and bottom of the PC board. This PC foil must then be connected to a voltage which is at the same voltage as the amplifier inputs, since no leakage current can flow between two points at the same potential. For example, a PC board trace-to-pad resistance of $10^{12}\Omega$, which is normally considered a very large resistance, could leak 5 pA if the trace were a 5V bus adjacent to the pad of the input. This would cause a 30 times degradation from the LMC6462/4's actual performance. However, if a guard ring is held within 5 mV of the inputs, then even a resistance of $10^{11}\Omega$ would cause only 0.05 pA of leakage current. See Figure 12 for typical connections of guard rings for standard op-amp configurations.

Application Information (Continued)

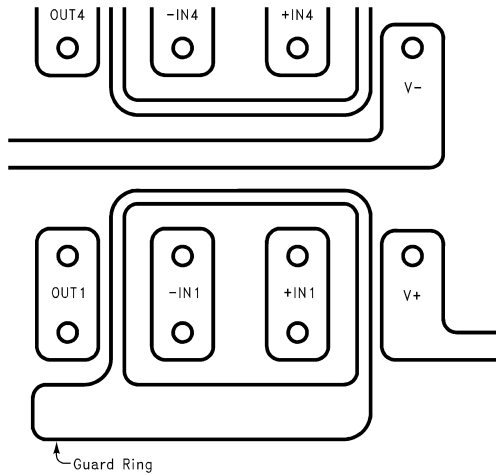
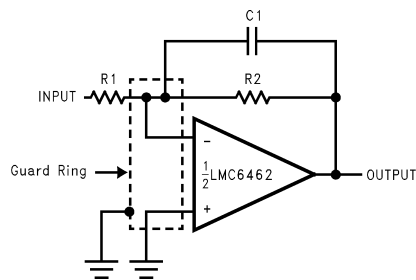
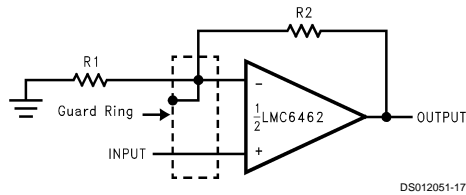

FIGURE 11. Example of Guard Ring in P.C. Board Layout



Inverting Amplifier



Non-Inverting Amplifier

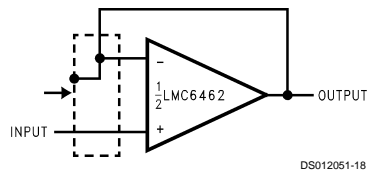

Follower

FIGURE 12. Typical Connections of Guard Rings

The designer should be aware that when it is inappropriate to lay out a PC board for the sake of just a few circuits, there is another technique which is even better than a guard ring on a PC board: Don't insert the amplifier's input pin into the

board at all, but bend it up in the air and use only air as an insulator. Air is an excellent insulator. In this case you may have to forego some of the advantages of PC board construction, but the advantages are sometimes well worth the effort of using point-to-point up-in-the-air wiring. See Figure 13.

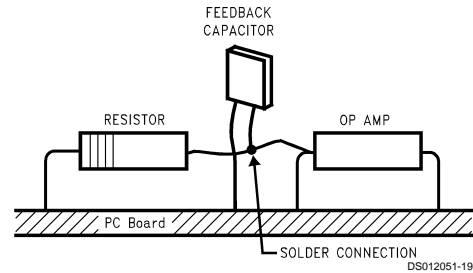

(Input pins are lifted out of PC board and soldered directly to components. All other pins connected to PC board.)

FIGURE 13. Air Wiring

Application Information (Continued)

8.0 Instrumentation Circuits

The LMC6464 has the high input impedance, large common-mode range and high CMRR needed for designing instrumentation circuits. Instrumentation circuits designed with the LMC6464 can reject a larger range of common-mode signals than most in-amps. This makes instrumentation circuits designed with the LMC6464 an excellent choice for noisy or industrial environments. Other appli-

cations that benefit from these features include analytic and medical instruments, magnetic field detectors, gas detectors, and silicon-based transducers.

A small valued potentiometer is used in series with R_G to set the differential gain of the three op-amp instrumentation circuit in *Figure 14*. This combination is used instead of one large valued potentiometer to increase gain trim accuracy and reduce error due to vibration.

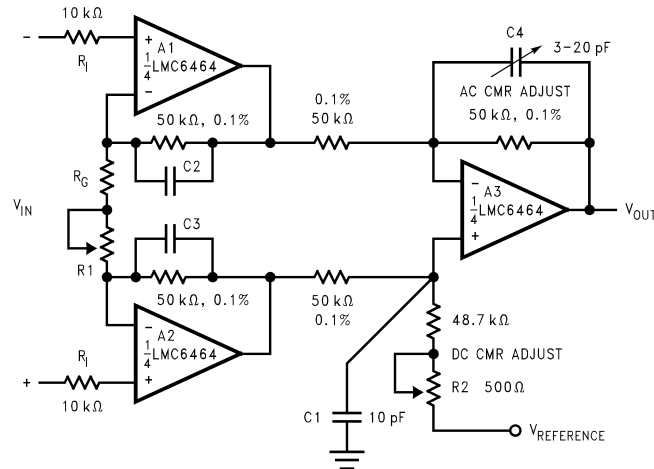

FIGURE 14. Low Power Three Op-Amp Instrumentation Amplifier

A two op-amp instrumentation amplifier designed for a gain of 100 is shown in *Figure 15*. Low sensitivity trimming is made for offset voltage, CMRR and gain. Low cost and low power consumption are the main advantages of this two op-amp circuit.

Higher frequency and larger common-mode range applications are best facilitated by a three op-amp instrumentation amplifier.

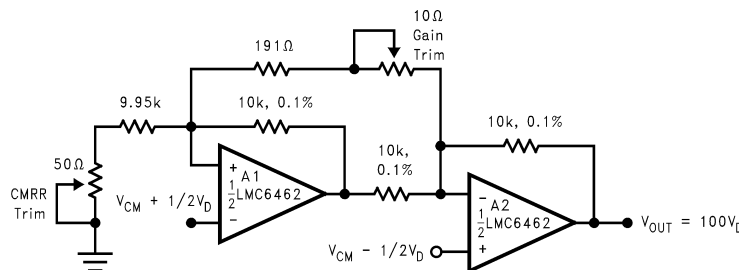
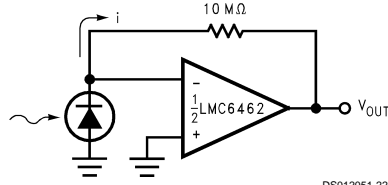

FIGURE 15. Low-Power Two-Op-Amp Instrumentation Amplifier

Typical Single-Supply Applications

TRANSDUCER INTERFACE CIRCUITS



DS012051-22

FIGURE 16. Photo Detector Circuit

Photocells can be used in portable light measuring instruments. The LMC6462, which can be operated off a battery, is an excellent choice for this circuit because of its very low input current and offset voltage.

LMC6462 AS A COMPARATOR

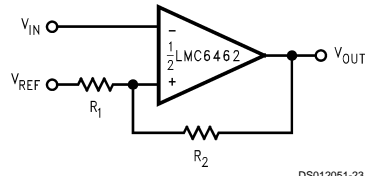

DS012051-23

FIGURE 17. Comparator with Hysteresis

Figure 17 shows the application of the LMC6462 as a comparator. The hysteresis is determined by the ratio of the two resistors. The LMC6462 can thus be used as a micropower comparator, in applications where the quiescent current is an important parameter.

HALF-WAVE AND FULL-WAVE RECTIFIERS

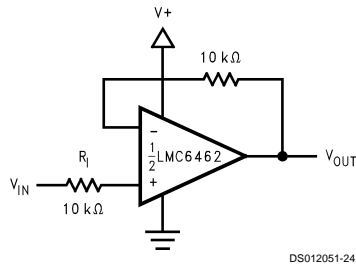

DS012051-24

FIGURE 18. Half-Wave Rectifier with Input Current Protection (R₁)

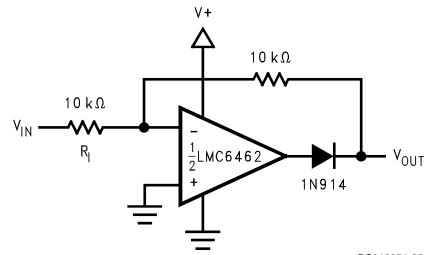

DS012051-25

FIGURE 19. Full-Wave Rectifier with Input Current Protection (R₁)

In Figure 18 Figure 19, R₁ limits current into the amplifier since excess current can be caused by the input voltage exceeding the supply voltage.

PRECISION CURRENT SOURCE

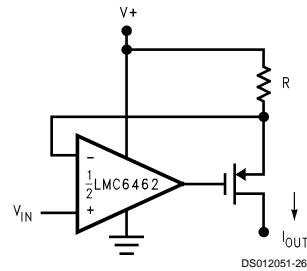

DS012051-26

FIGURE 20. Precision Current Source

The output current I_{OUT} is given by:

$$I_{OUT} = \left(\frac{V^+ - V_{IN}}{R} \right)$$

OSCILLATORS

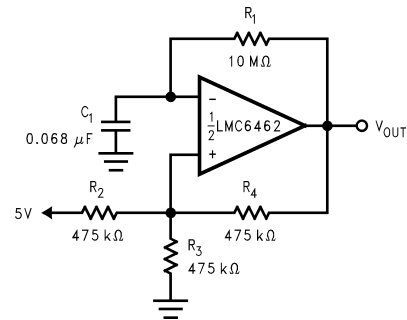

DS012051-27

FIGURE 21. 1 Hz Square-Wave Oscillator

For single supply 5V operation, the output of the circuit will swing from 0V to 5V. The voltage divider set up R₂, R₃ and R₄ will cause the non-inverting input of the LMC6462 to move from 1.67V (1/3 of 5V) to 3.33V (2/3 of 5V). This voltage behaves as the threshold voltage.

R₁ and C₁ determine the time constant of the circuit. The frequency of oscillation, f_{OSC} is

Typical Single-Supply Applications

(Continued)

$$\left(\frac{1}{2\Delta t} \right)$$

where Δt is the time the amplifier input takes to move from 1.67V to 3.33V. The calculations are shown below.

$$1.67 = 5 \left(1 - e^{-\frac{t}{\tau}} \right)$$

where $\tau = RC = 0.68$ seconds

$\rightarrow t_1 = 0.27$ seconds.

and

$$3.33 = 5 \left(1 - e^{-\frac{t}{\tau}} \right)$$

$\rightarrow t_2 = 0.75$ seconds

Then,

$$f_{\text{OSC}} = \left(\frac{1}{2\Delta t} \right)$$

$$= \frac{1}{2(0.75 - 0.27)}$$

= 1 Hz

LOW FREQUENCY NULL

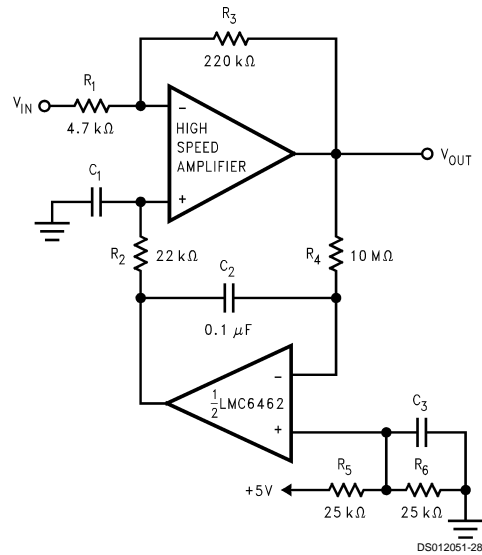

FIGURE 22. High Gain Amplifier with Low Frequency Null

Output offset voltage is the error introduced in the output voltage due to the inherent input offset voltage V_{OS} of an amplifier.

Output Offset Voltage = (Input Offset Voltage) (Gain)

In the above configuration, the resistors R_5 and R_6 determine the nominal voltage around which the input signal, V_{IN} should be symmetrical. The high frequency component of the input signal V_{IN} will be unaffected while the low frequency component will be nulled since the DC level of the output will be the input offset voltage of the LMC6462 plus the bias voltage. This implies that the output offset voltage due to the top amplifier will be eliminated.

Physical Dimensions inches (millimeters) unless otherwise noted

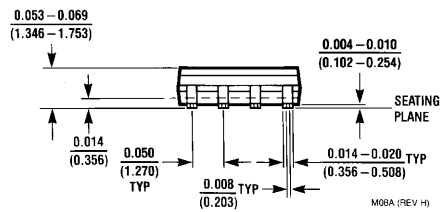
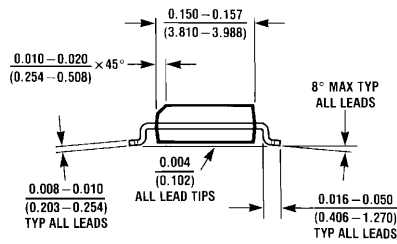
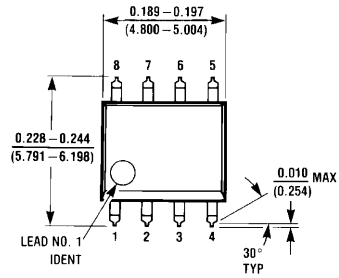

8-Pin Small Outline Package
Order Number LMC6462AIM or LMC6462BIM
NS Package Number M08A

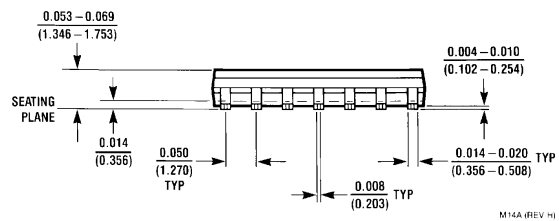
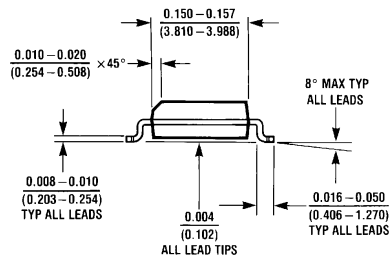
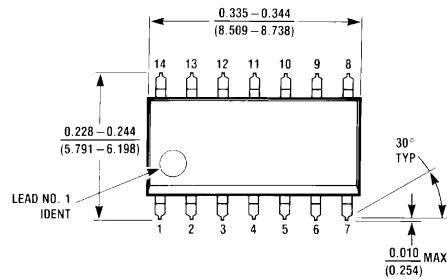

14-Pin Small Outline Package
Order Number LMC6464AIM or LMC6464BIM
NS Package Number M14A

Physical Dimensions inches (millimeters) unless otherwise noted (Continued)

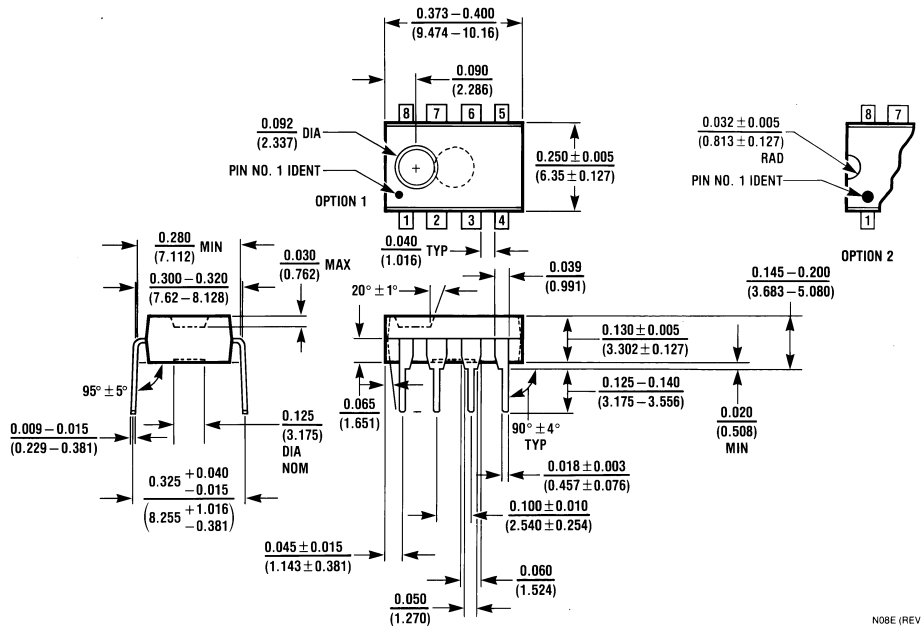

8-Pin Molded Dual-In-Line Package
 Order Number LMC6462AIN or LMC6462BIN
 NS Package Number N08E

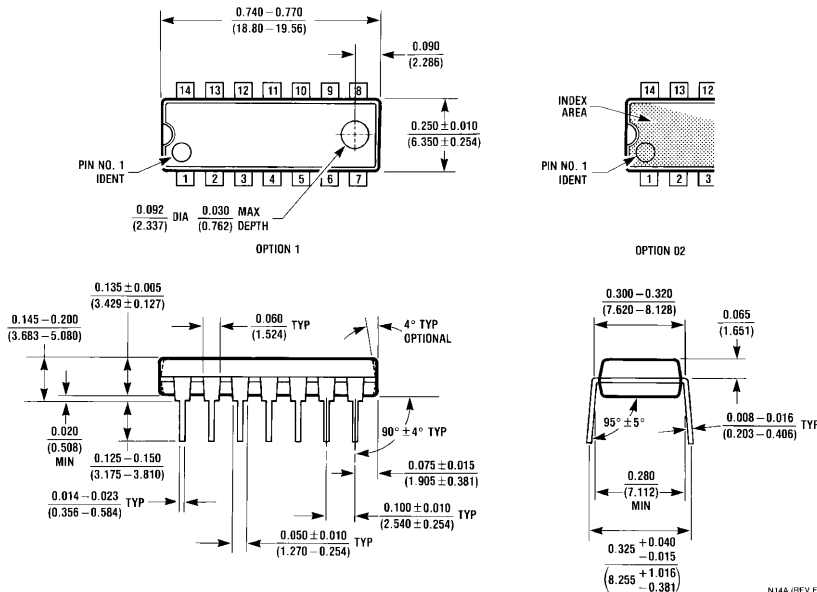

14-Pin Molded Dual-In-Line Package
 Order Number LMC6462AIN or LMC6464BIN
 NS Package Number N14A

Notes

LIFE SUPPORT POLICY

NATIONAL'S PRODUCTS ARE NOT AUTHORIZED FOR USE AS CRITICAL COMPONENTS IN LIFE SUPPORT DEVICES OR SYSTEMS WITHOUT THE EXPRESS WRITTEN APPROVAL OF THE PRESIDENT AND GENERAL COUNSEL OF NATIONAL SEMICONDUCTOR CORPORATION. As used herein:

1. Life support devices or systems are devices or systems which, (a) are intended for surgical implant into the body, or (b) support or sustain life, and whose failure to perform when properly used in accordance with instructions for use provided in the labeling, can be reasonably expected to result in a significant injury to the user.
2. A critical component is any component of a life support device or system whose failure to perform can be reasonably expected to cause the failure of the life support device or system, or to affect its safety or effectiveness.



National Semiconductor Corporation
Americas
Tel: 1-800-272-9959
Fax: 1-800-737-7018
Email: support@nsc.com

www.national.com

National Semiconductor Europe
Fax: +49 (0) 1 80-530 85 86
Email: europe.support@nsc.com
Deutsch Tel: +49 (0) 1 80-530 85 85
English Tel: +49 (0) 1 80-532 78 32
Français Tel: +49 (0) 1 80-532 93 58
Italiano Tel: +49 (0) 1 80-534 16 80

National Semiconductor Asia Pacific Customer Response Group
Tel: 65-2544466
Fax: 65-2504466
Email: sea.support@nsc.com

National Semiconductor Japan Ltd.
Tel: 81-3-5639-7560
Fax: 81-3-5639-7507