

# LMH6672

## Dual, High Output Current, High Speed Op Amp

### General Description

The LMH6672 is a low cost, dual high speed op amp capable of driving signals to within 1V of the power supply rails. It features the high output drive with low distortion required for the demanding application of a single supply xDSL line driver.

When connected as a differential output driver, the LMH6672 can drive a 50Ω load to 16.8V<sub>PP</sub> swing with only -93dBc distortion, fully supporting the peak upstream power levels for upstream full-rate ADSL. The LMH6672 is fully specified for operation with 5V and 12V supplies. Ideal for PCI modem cards and xDSL modems.

### Applications

- ADSL PCI modem cards
- xDSL external modems
- Line drivers

### Features

- **High Output Drive**  
19.2V<sub>PP</sub> differential output voltage, R<sub>L</sub> = 50Ω  
9.6V<sub>PP</sub> single-ended output voltage, R<sub>L</sub> = 25Ω
- **High Output Current**  
±200mA @ V<sub>O</sub> = 9V<sub>PP</sub>, V<sub>S</sub> = 12V
- **Low Distortion**  
93dB SFDR @ 100KHz, V<sub>O</sub> = 8.4V<sub>PP</sub>, R<sub>L</sub> = 25Ω  
92dB SFDR @ 1MHz, V<sub>O</sub> = 2V<sub>PP</sub>, R<sub>L</sub> = 100Ω
- **High Speed**  
130MHz 3dB bandwidth (G = 2)  
160V/μs slew rate
- **Low Noise**  
4.5nV/√Hz : input noise voltage  
1.7pA/√Hz : input noise current
- Low supply current: 6.2mA/amp
- Single-supply operation: 5V to 12V
- Available in 8-pin SOIC, PSOP and LLP

### Connection Diagram

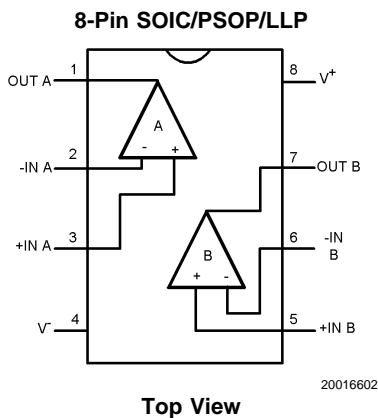

### Typical Application

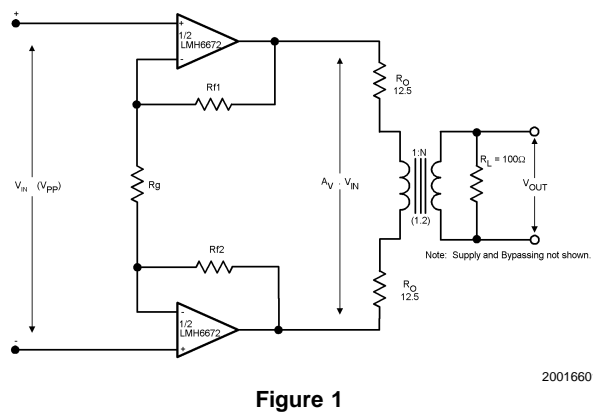

### Ordering Information

Package	Part Number	Package Marking	Transport Media	NSC Drawing
8-Pin SOIC	LMH6672MA	LMH6672MA	Rails	M08A
	LMH6672MAX	LMH6672MA	2.5k Units Tape and Reel	
8-Pin PSOP	LMH6672MR	LMH6672MR	Rails	MRA08A
	LMH6672MRX	LMH6672MR	2.5k Units Tape and Reel	
8-Pin LLP	LMH6672LD	L6672LD	1k Units Tape and Reel	LDC08A
	LMH6672LDX	L6672LD	4.5k Units Tape and Reel	

**Absolute Maximum Ratings** (Note 1)

If Military/Aerospace specified devices are required, please contact the National Semiconductor Sales Office/Distributors for availability and specifications.

ESD Tolerance	(Note 2)
Human Body Model	2kV
Machine Model	200V
$V_{IN}$ Differential	$\pm 1.2V$
Output Short Circuit Duration	(Note 2)
Supply Voltage ( $V^+ - V^-$ )	13.2V
Voltage at Input/Output pins	$V^+ +0.8V, V^- -0.8V$
Storage Temperature Range	$-65^\circ C$ to $+150^\circ C$
Junction Temperature	$+150^\circ C$ (Note 4)

## Soldering Information

Infrared or Convection (20 sec)	$235^\circ C$
Wave Soldering (10 sec)	$260^\circ C$

**Operating Ratings** (Note 1)

Supply Voltage ( $V^+ - V^-$ )	$\pm 2.5V$ to $\pm 6.5V$
Junction Temperature Range	$-40^\circ C$ to $150^\circ C$
Package Thermal Resistance ( $\theta_{JA}$ )	
8-pin SOIC	$172^\circ C/W$
8-pin PSOP	$58.6^\circ C/W$
8-pin LLP	$40^\circ C/W$

**Electrical Characteristics**

$T_J = 25^\circ C, G = +2, V_S = \pm 2.5$  to  $\pm 6V, R_f = R_{IN} = 470\Omega, R_L = 100\Omega$ ; Unless otherwise specified.

Symbol	Parameter	Conditions	Min (Note 6)	Typ (Note 5)	Max (Note 6)	Units
<b>Dynamic Performance</b>						
	-3dB Bandwidth			130		MHz
	0.1dB Bandwidth	$V_S = \pm 6V$		22		MHz
	Slew Rate	$V_S = \pm 6V, 4V$ Step, 10-90%		170		V/ $\mu s$
	Rise and Fall Time	$V_S = 6V, 4V$ Step, 10-90%		18.5		ns
<b>Distortion and Noise Response</b>						
	2 <sup>nd</sup> Harmonic Distortion	$V_O = 8.4V_{PP}, f = 100KHz, R_L = 25\Omega$		-95		dBc
		$V_O = 8.4V_{PP}, f = 1MHz, R_L = 100\Omega$		-92		dBc
	3 <sup>rd</sup> Harmonic Distortion	$V_O = 8.4V_{PP}, f = 100KHz, R_L = 25\Omega$		-93		dBc
		$V_O = 2V_{PP}, f = 1MHz, R_L = 100\Omega$		-95		dBc
	Input Noise Voltage	$f = 100KHz$		4.5		nV/ $\sqrt{Hz}$
	Input Noise Current	$f = 100KHz$		1.7		pA/ $\sqrt{Hz}$
<b>Input Characteristics</b>						
$V_{OS}$	Input Offset Voltage	$T_J = -40^\circ C$ to $150^\circ C$	-5.5	-0.2	5.5	mV
			-4	-0.2	4	
$I_B$	Input Bias Current	$T_J = -40^\circ C$ to $150^\circ C$		8	14	$\mu A$
$I_{OS}$	Input Offset Current	$T_J = -40^\circ C$ to $150^\circ C$	-2.1	0	2.1	$\mu A$
CMVR	Common Voltage Range	$V_S = \pm 6V$	-6.0		4.5	V
CMRR	Common-Mode Rejection Ratio	$V_S = \pm 6V, T_J = -40^\circ C$ to $150^\circ C$	150	9.5		$\mu V/V$
<b>Transfer Characteristics</b>						
$A_{VOL}$	Voltage Gain	$R_L = 1k, T_J = -40^\circ C$ to $150^\circ C$	1.0	2.5		V/mV
		$R_L = 25\Omega, T_J = -40^\circ C$ to $150^\circ C$	0.67	1.7		V/mV
	Output Swing	$R_L = 25\Omega, V_S = \pm 6V$	-4.5	$\pm 4.8$	4.5	V
		$R_L = 25\Omega, T_J = -40^\circ C$ to $150^\circ C, V_S = \pm 6V$	-4.4	$\pm 4.8$	4.4	
	Output Swing	$R_L = 1k, V_S = \pm 6V$	-4.8	$\pm 4.8$	4.8	V
		$R_L = 1k, T_J = -40^\circ C$ to $150^\circ C, V_S = \pm 6V$	-4.7	$\pm 4.8$	4.7	
$I_{SC}$	Output Current (Note 3)	$V_O = 0, V_S = \pm 6V$	400	788		mA
		$V_O = 0, V_S = \pm 6V, T_J = -40^\circ C$ to $150^\circ C$	260	600		mA
<b>Power Supply</b>						

## Electrical Characteristics (Continued)

$T_J = 25^\circ\text{C}$ ,  $G = +2$ ,  $V_S = \pm 2.5$  to  $\pm 6\text{V}$ ,  $R_f = R_{IN} = 470\Omega$ ,  $R_L = 100\Omega$ ; Unless otherwise specified.

Symbol	Parameter	Conditions	Min (Note 6)	Typ (Note 5)	Max (Note 6)	Units
$I_S$	Supply Current/Amp	$V_S = \pm 6\text{V}$			8	mA
		$V_S = \pm 6\text{V}$ , $T_J = -40^\circ\text{C}$ to $150^\circ\text{C}$		6.2	9	
PSRR	Power Supply Rejection Ratio	$V_S = \pm 2.5\text{V}$ to $\pm 6\text{V}$ , $T_J = -40^\circ\text{C}$ to $150^\circ\text{C}$	72	78		dB

## $\pm 2.5\text{V}$ Electrical Characteristics

$T_J = 25^\circ\text{C}$ ,  $G = +2$ ,  $V_S = \pm 2.5$  to  $\pm 6\text{V}$ ,  $R_f = R_{IN} = 470\Omega$ ,  $R_L = 100\Omega$ ; Unless otherwise specified.

Symbol	Parameter	Conditions	Min (Note 6)	Typ (Note 5)	Max (Note 6)	Units
--------	-----------	------------	-----------------	-----------------	-----------------	-------

### Dynamic Performance

	-3dB Bandwidth			125		MHz
	0.1dB Bandwidth			32		MHz
	Slew Rate	0.4V Step, 10-90%		115		V/ $\mu\text{s}$
	Rise and Fall Time	0.4V Step, 10-90%		2.75		ns

### Distortion and Noise Response

	2 <sup>nd</sup> Harmonic Distortion	$V_O = 2V_{PP}$ , $f = 100\text{KHz}$ , $R_L = 25\Omega$		-85		dBc
		$V_O = 2V_{PP}$ , $f = 1\text{MHz}$ , $R_L = 100\Omega$		-87		dBc
	3 <sup>rd</sup> Harmonic Distortion	$V_O = 2V_{PP}$ , $f = 100\text{KHz}$ , $R_L = 25\Omega$		-90		dBc
		$V_O = 2V_{PP}$ , $f = 1\text{MHz}$ , $R_L = 100\Omega$		-88		dBc

### Input Characteristics

$V_{OS}$	Input Offset Voltage	$T_J = -40^\circ\text{C}$ to $150^\circ\text{C}$	-5.5		5.5	mV
			-4.0	1.1	4.0	
$I_B$	Input Bias Current	$T_J = -40^\circ\text{C}$ to $150^\circ\text{C}$		8.0	14	$\mu\text{A}$
CMVR	Common-Mode Voltage Range		-2.5		1.0	V
CMRR	Common-Mode Rejection Ratio	$T_J = -40^\circ\text{C}$ to $150^\circ\text{C}$	150	57		$\mu\text{V/V}$

### Transfer Characteristics

$A_{VOL}$	Voltage Gain	$R_L = 25\Omega$ , $T_J = -40^\circ\text{C}$ to $150^\circ\text{C}$	0.67	1.54		V/mV
		$R_L = 1\text{k}$ , $T_J = -40^\circ\text{C}$ to $150^\circ\text{C}$	1.0	2.0		

### Output Characteristics

$V_O$	Output Voltage Swing	$R_L = 25\Omega$	1.20	1.45		V
		$R_L = 25\Omega$ , $T_J = -40^\circ\text{C}$ to $150^\circ\text{C}$	1.10	1.35		
		$R_L = 1\text{k}$	1.30	1.60		
		$R_L = 1\text{k}$ , $T_J = -40^\circ\text{C}$ to $150^\circ\text{C}$	1.25	1.50		

### Power Supply

$I_S$	Supply Current/Amp				8.0	mA
		$T_J = -40^\circ\text{C}$ to $150^\circ\text{C}$		5.6	9.0	

**Note 1:** Absolute Maximum Ratings indicate limits beyond which damage to the device may occur. Operating Ratings indicate conditions for which the device is intended to be functional, but specific performance is not guaranteed. For guaranteed specifications and the test conditions, see the Electrical Characteristics.

**Note 2:** Human body model, 1.5k $\Omega$  in series with 100pF. Machine model, 200 $\Omega$  in series with 100pF.

**Note 3:** Shorting the output to either supply or ground will exceed the absolute maximum  $T_J$  and can result in failure.

**Note 4:** The maximum power dissipation is a function of  $T_{J(MAX)}$ ,  $\theta_{JA}$  and  $T_A$ . The maximum allowable power dissipation at any ambient temperature is  $P_D = (T_{J(MAX)} - T_A)/\theta_{JA}$ . All numbers apply for packages soldered directly onto a PC board.

**Note 5:** Typical values represent the most likely parametric norm.

**Note 6:** All limits are guaranteed by testing, characterization or statistical analysis.

**Typical Performance Characteristics** At  $T_J = 25^\circ\text{C}$ ,  $R_F = 470\Omega$  gain = +2,  $R_L = 100\Omega$ . Unless otherwise specified.

**Output Swing  $R_L = 25\Omega, 1k\Omega$  @  $-40^\circ\text{C}, 25^\circ\text{C}, 85^\circ\text{C}$**

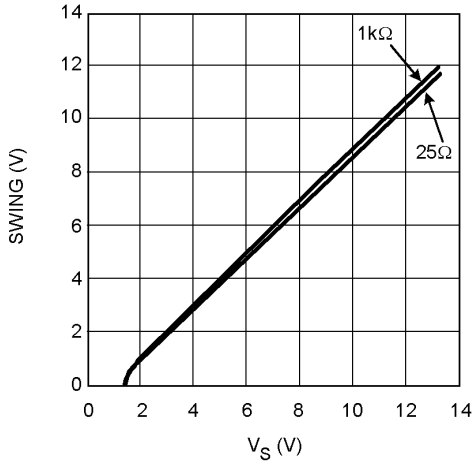

20016635

**Positive Output Swing into  $1k\Omega$**

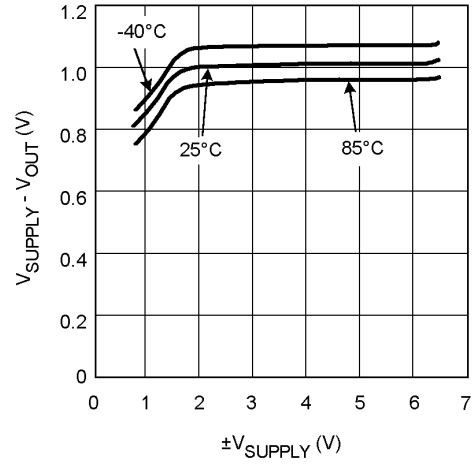

20016645

**Negative Output Swing into  $1k\Omega$**

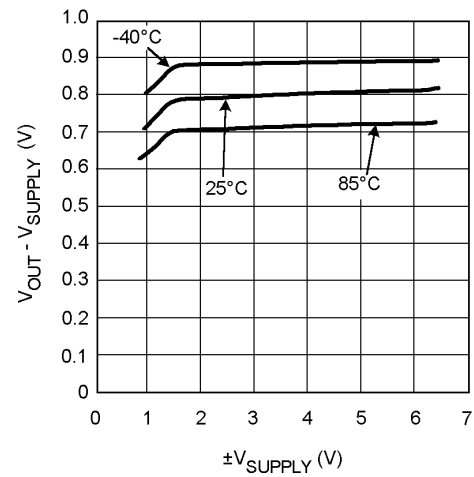

20016646

**Positive Output Swing into  $25\Omega$**

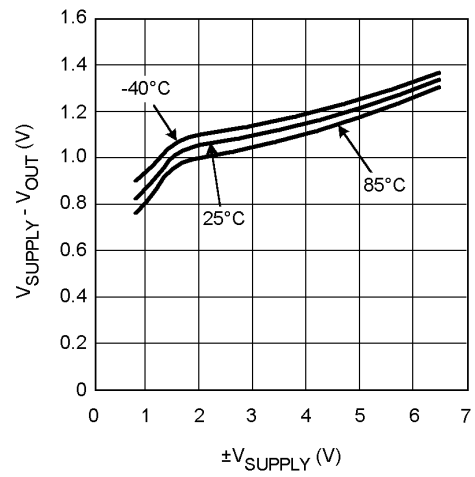

20016644

**Negative Output Swing into  $25\Omega$**

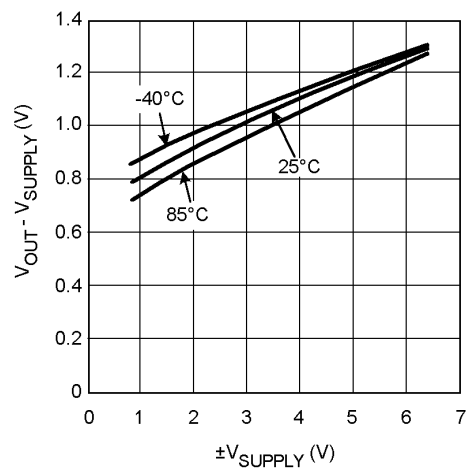

20016647

**+ $V_{\text{OUT}}$  vs.  $I_{\text{LOAD}}$**

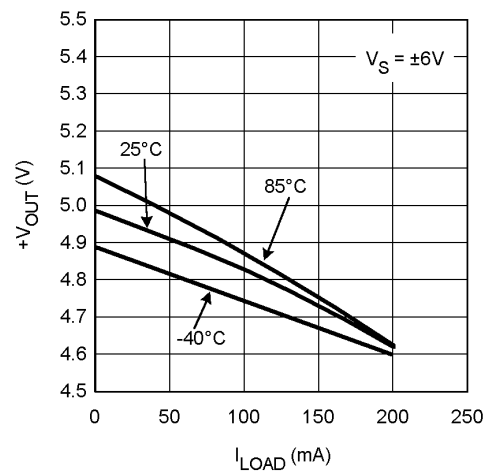

20016640

**Typical Performance Characteristics** At  $T_J = 25^\circ\text{C}$ ,  $R_F = 470\Omega$  gain = +2,  $R_L = 100\Omega$ . Unless otherwise specified. (Continued)

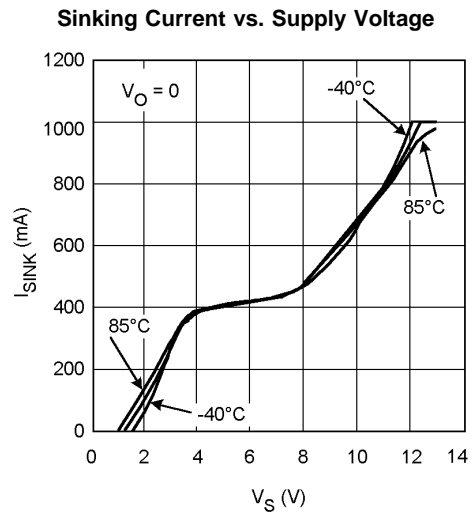
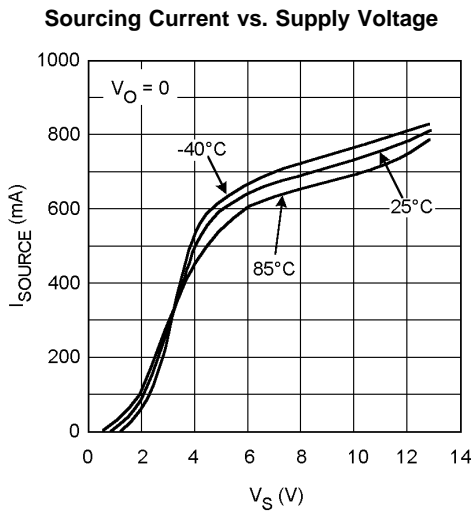
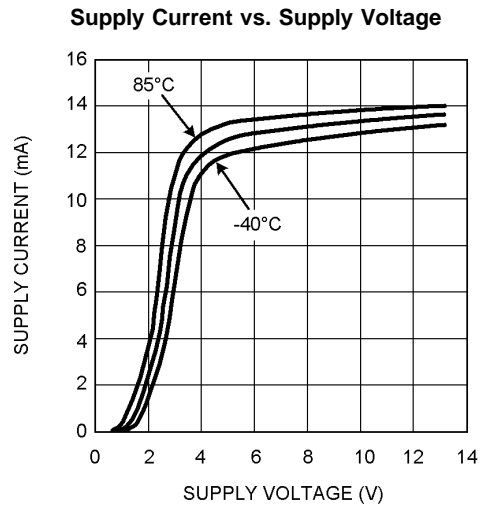
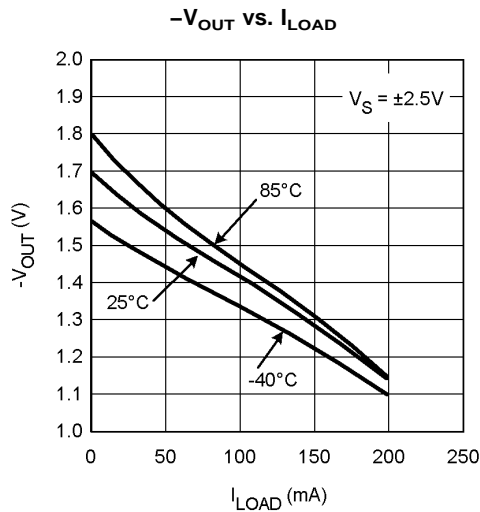
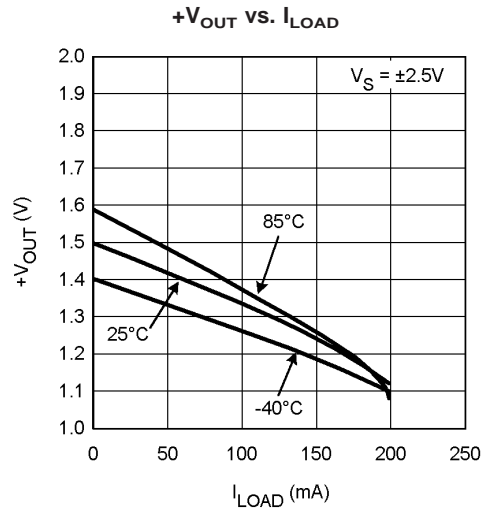
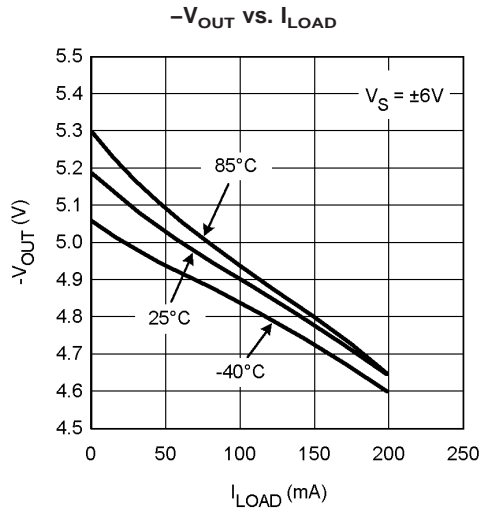

**Typical Performance Characteristics** At  $T_J = 25^\circ\text{C}$ ,  $R_F = 470\Omega$  gain = +2,  $R_L = 100\Omega$ . Unless otherwise specified. (Continued)

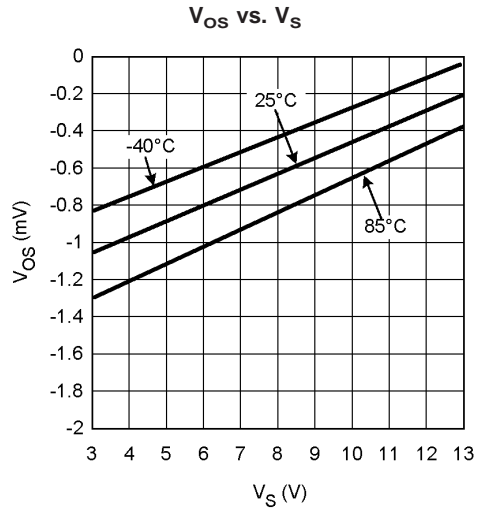

20016629

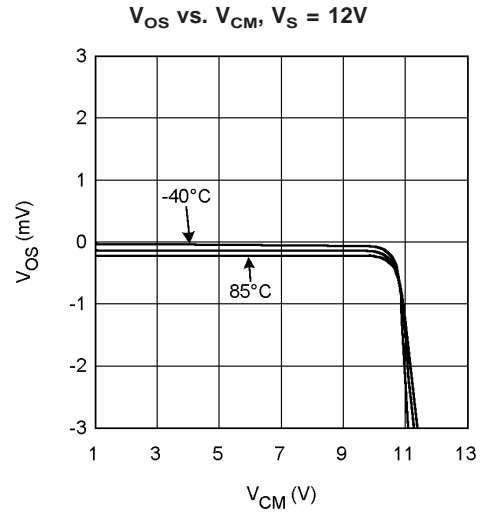

20016631

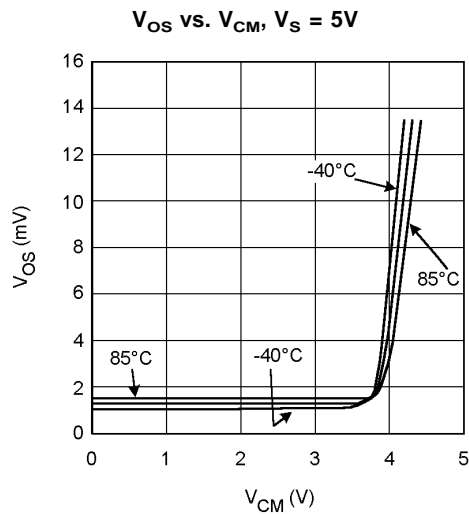

20016630

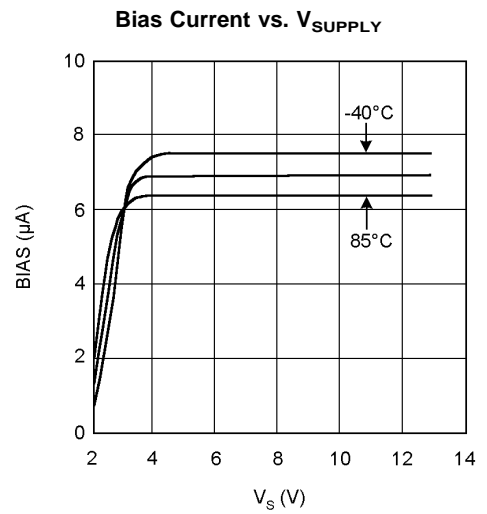

20016636

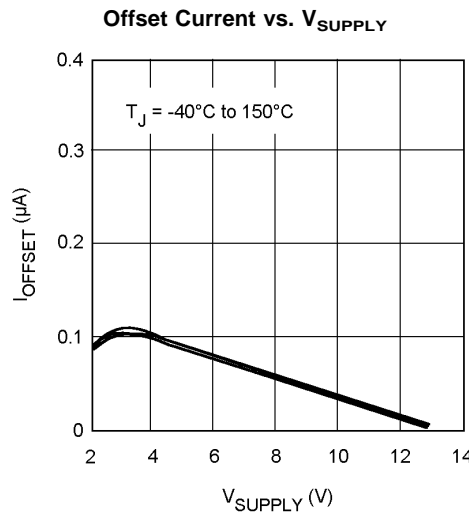

20016637

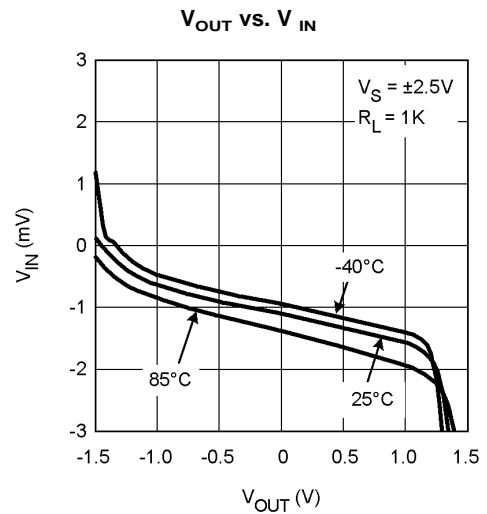

20016639

**Typical Performance Characteristics** At  $T_J = 25^\circ\text{C}$ ,  $R_F = 470\Omega$  gain = +2,  $R_L = 100\Omega$ . Unless otherwise specified. (Continued)

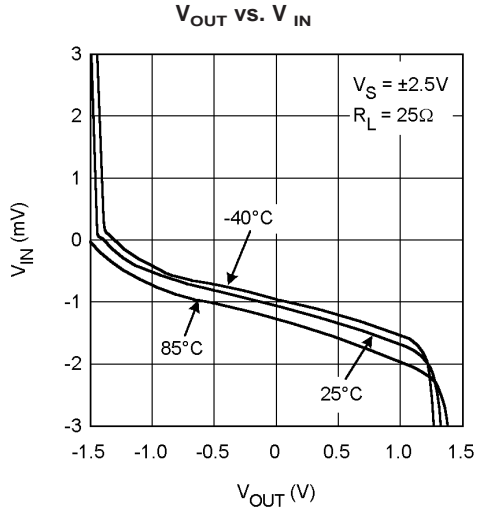

20016638

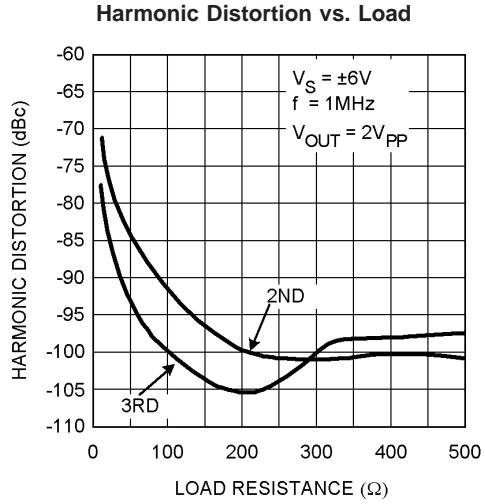

20016620

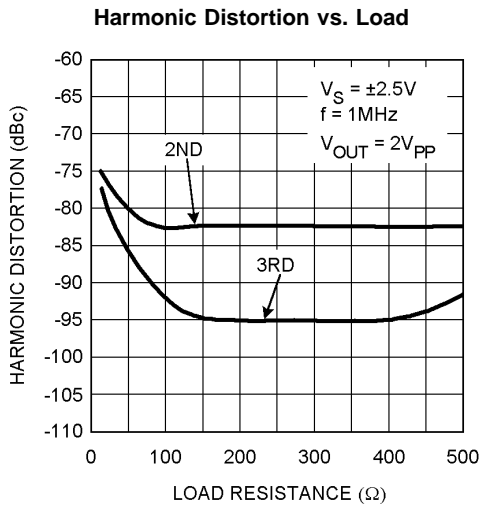

20016619

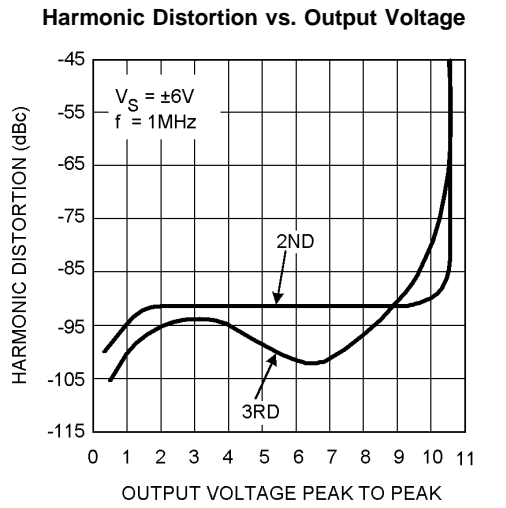

20016614

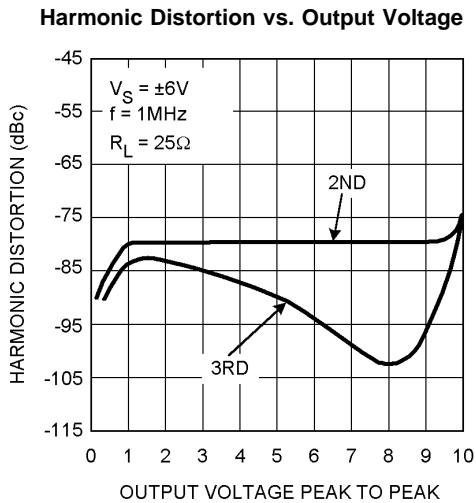

20016613

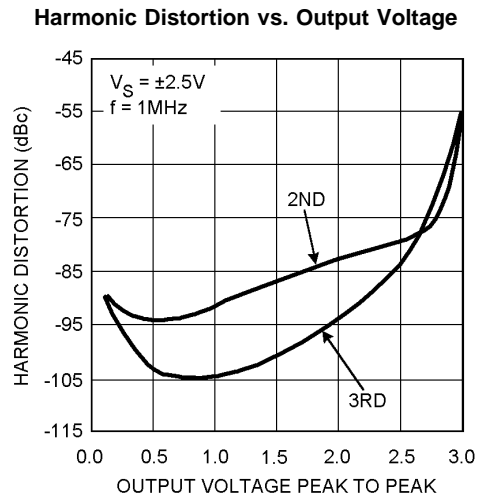

20016612

**Typical Performance Characteristics** At  $T_J = 25^\circ\text{C}$ ,  $R_F = 470\Omega$  gain = +2,  $R_L = 100\Omega$ . Unless otherwise specified. (Continued)

**Harmonic Distortion vs. Output Voltage**

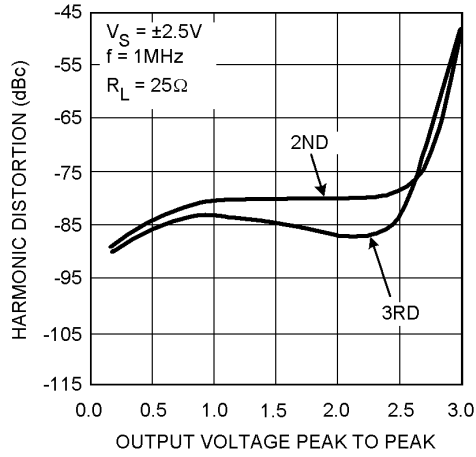

20016611

**Harmonic Distortion vs. Output Voltage**

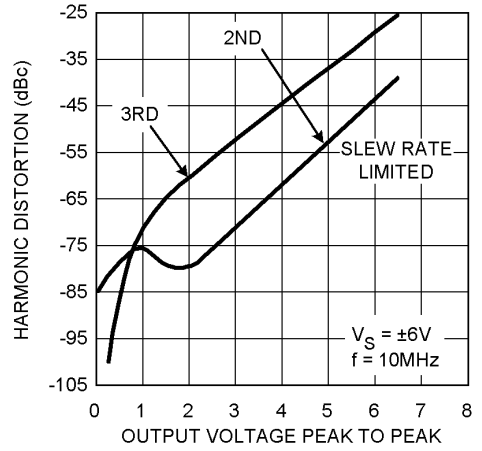

20016615

**Harmonic Distortion vs. Output Voltage**

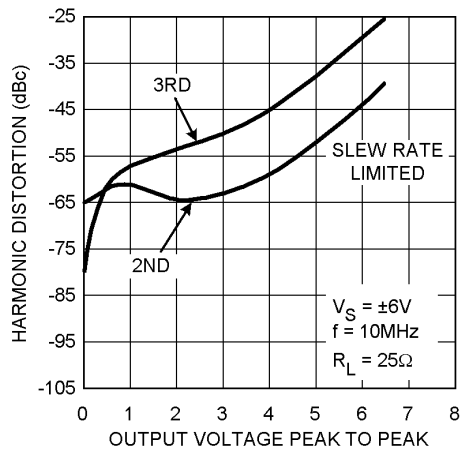

20016617

**Harmonic Distortion vs. Output Voltage**

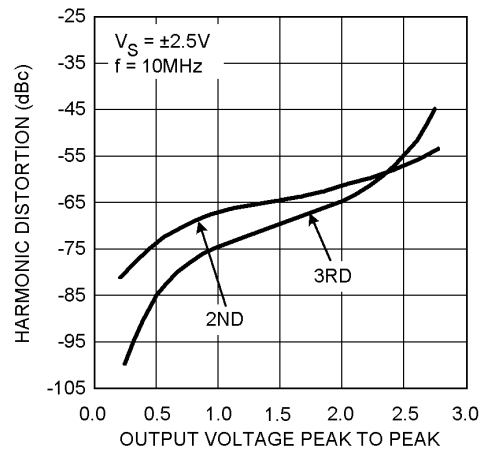

20016616

**Harmonic Distortion vs. Output Voltage**

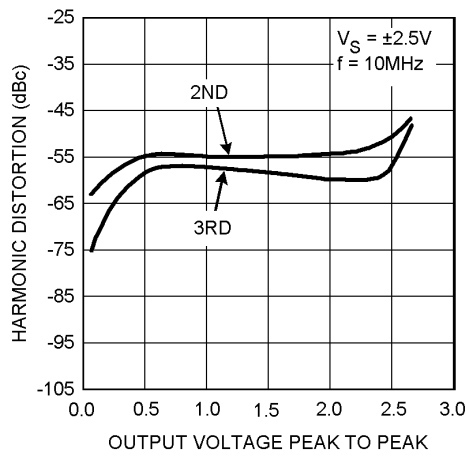

20016618

**Harmonic Distortion vs. Frequency**

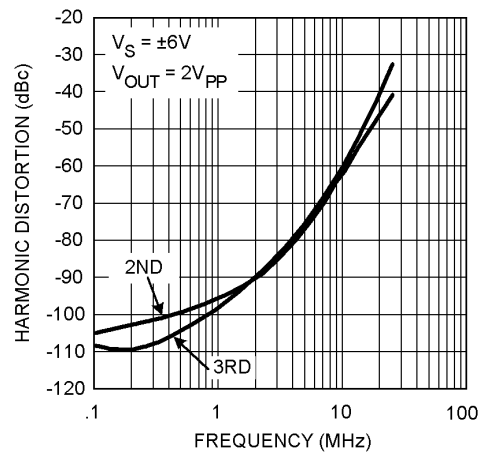

20016622



**Typical Performance Characteristics** At  $T_J = 25^\circ\text{C}$ ,  $R_F = 470\Omega$  gain = +2,  $R_L = 100\Omega$ . Unless otherwise specified. (Continued)

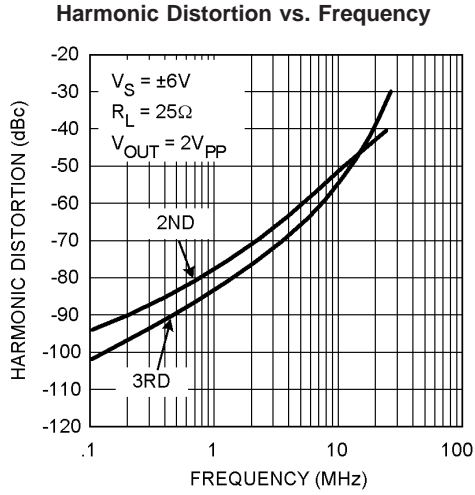

20016621

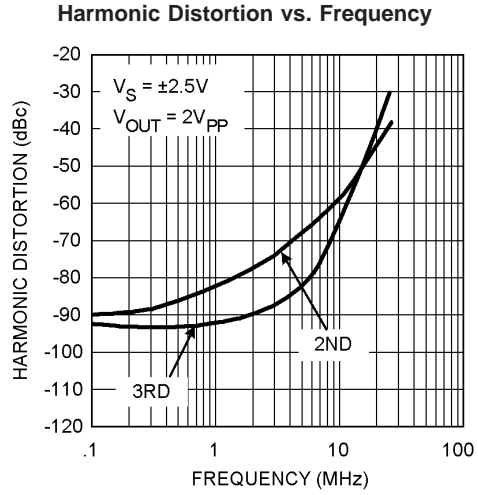

20016623

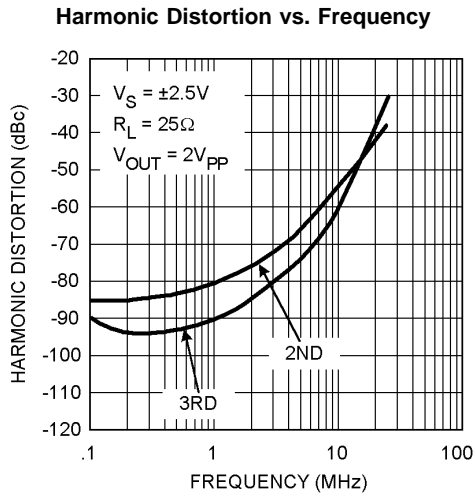

20016624

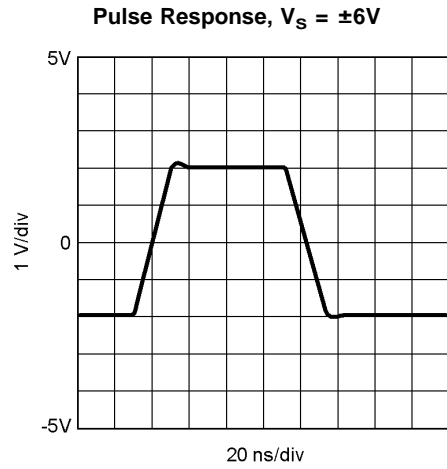

20016627

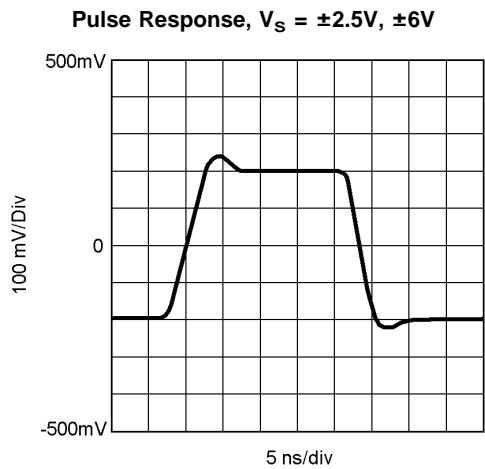

20016628

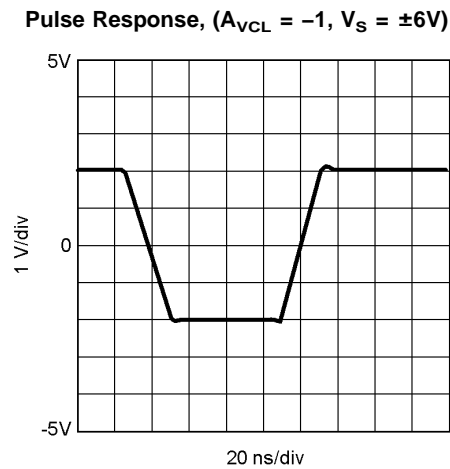

20016626

**Typical Performance Characteristics** At  $T_J = 25^\circ\text{C}$ ,  $R_F = 470\Omega$  gain = +2,  $R_L = 100\Omega$ . Unless otherwise specified. (Continued)

**Pulse Response, ( $A_{VCL} = -1$ ,  $V_S = \pm 2.5\text{V}, \pm 6\text{V}$ )**

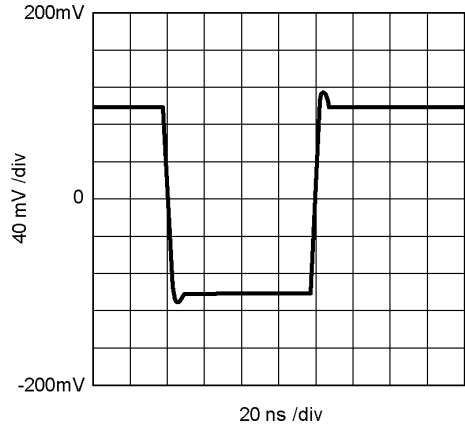

20016625

**Frequency Response**

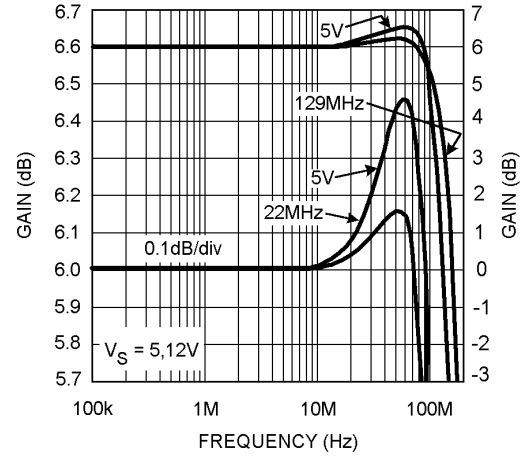

20016650

**Frequency Response,  $A_{VCL} = +5\text{V}$**

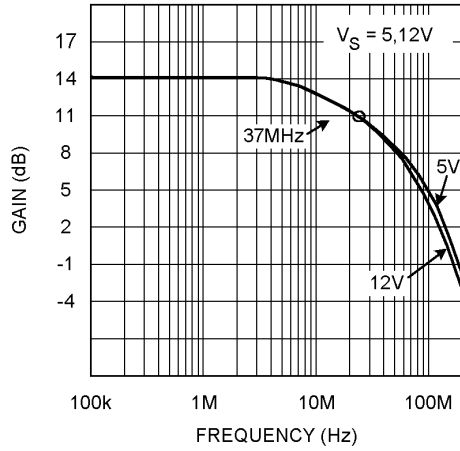

20016649

**Frequency Response,  $A_{VCL} = +10$**

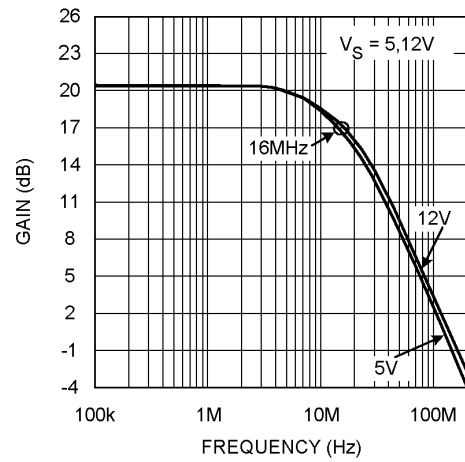

20016648

**CMRR vs. Frequency @ 12V**

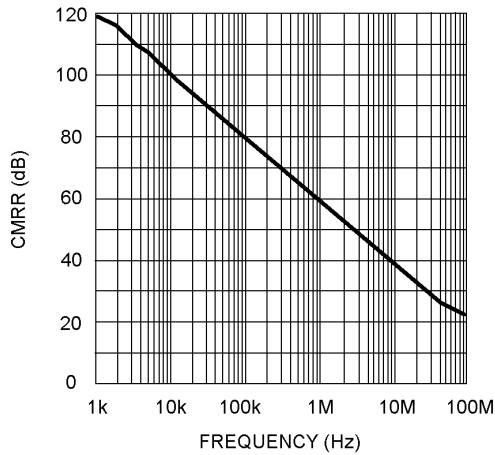

20016606

**CMRR vs. Frequency @ 5V**

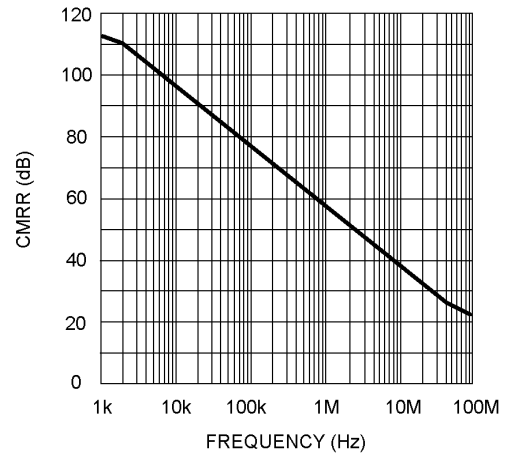

20016605

**Typical Performance Characteristics** At  $T_J = 25^\circ\text{C}$ ,  $R_F = 470\Omega$  gain = +2,  $R_L = 100\Omega$ . Unless otherwise specified. (Continued)

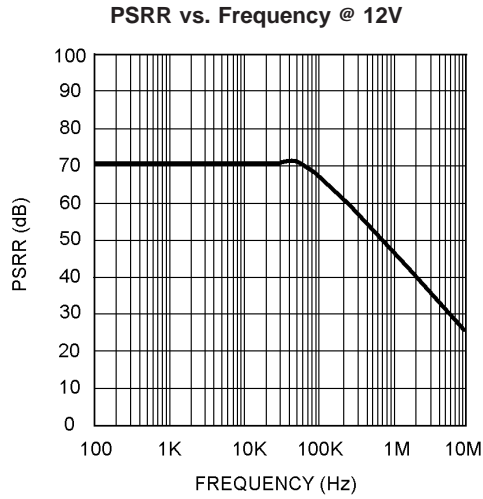

20016608

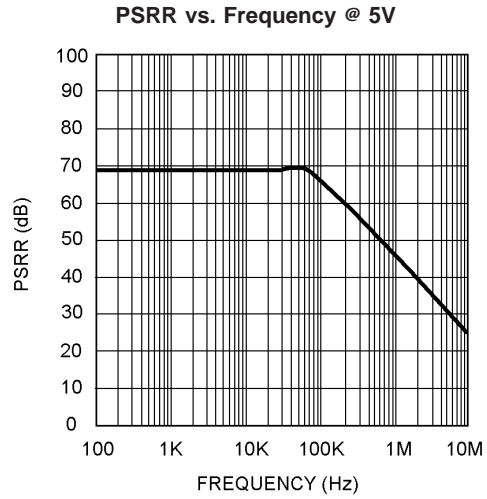

20016607

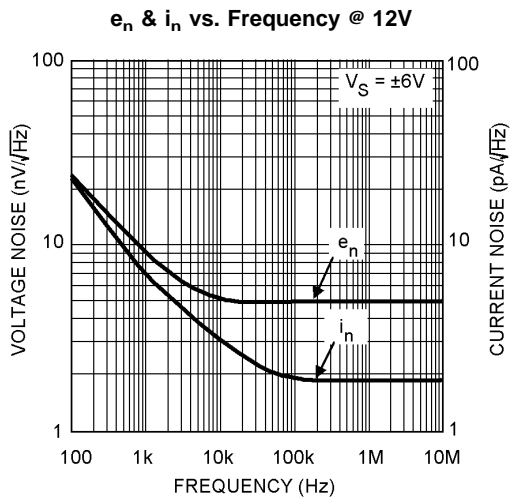

20016610

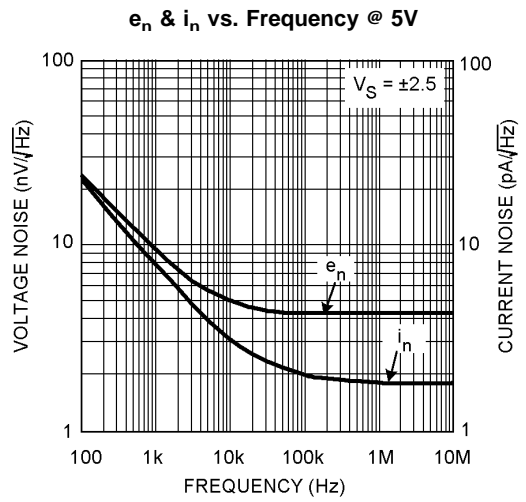

20016609

## Application Notes

### Thermal Management

The LMH6672 is a high-speed, high power, dual operational amplifier with a very high slew rate and very low distortion. For ease of use, it uses conventional voltage feedback. These characteristics make the LMH6672 ideal for applications where driving low impedances of 25-100Ω such as xDSL and active filters.

A class AB output stage allows the LMH6672 to deliver high currents to low impedance loads with low distortion while consuming low quiescent supply current. For most op-amps, class AB topology means that internal power dissipation is rarely an issue, even with the trend to smaller surface mount packages. However, the LMH6672 has been designed for applications where high levels of power dissipation may be encountered.

Several factors contribute to power dissipation and consequently higher junction temperatures. These factors need to be well understood if the LMH6672 is to perform to specifications in all applications. This section will examine the typical application that is shown on the front page of this data sheet as an example. (Figure 1) Because both amplifiers are in a single package, the calculations will for the total power dissipated by both amplifiers.

There are two separate contributors to the internal power dissipation:

1. The product of the supply voltage and the quiescent current when no signal is being delivered to the external load.

2. The additional power dissipated while delivering power to the external load.

The first of these components appears easy to calculate simply by inspecting the data sheet. The typical quiescent supply current for this part is 6.2mA per amplifier, therefore, with a (6 volt supply, the total power dissipation is:

$$P_D = V_S \times 2 \times I_Q = 12 \times (12.4 \times 10^{-3}) = 149 \text{ mW}$$

$$(V_S = V_{CC} + V_{EE})$$

With a thermal resistance of 172°C/W for the SOIC package, this level of internal power dissipation will result in a junction temperature ( $T_J$ ) of 26°C above ambient.

Using the worst-case maximum supply current of 18mA and an ambient of 85°C, a similar calculation results in a power dissipation of 216 mW, or a  $T_J$  of 122°C.

This is approaching the maximum allowed  $T_J$  of 150°C before a signal is applied. Fortunately, in normal operation, this term is reduced, for reasons that will soon be explained.

The second contributor to high  $T_J$  is the power dissipated internally when power is delivered to the external load. This cause of temperature rise is more difficult to calculate, even when the actual operating conditions are known.

To maintain low distortion, in a Class AB output stage, an idle current,  $I_Q$ , is maintained through the output transistors when there is little or no output signal. In the LMH6672, about 4.8 mA of the total quiescent supply current of 12.4 mA flows through the output stages.

Under normal large signal conditions, as the output voltage swings positive, one transistor of the output pair will conduct the load current, while the other transistor shuts off, and dissipates no power. During the negative signal swing this situation is reversed, with the lower transistor sinking the load current while the upper transistor is cut off. The current in each transistor will approximate a half wave rectified version of the total load current.

Because the output stage idle current is now routed into the load, 4.8mA can be subtracted from the quiescent supply current when calculating the quiescent power when the output is driving a load.

The power dissipation caused by driving a load in a DSL application, using a 1:2 turns ratio transformer driving 20 mW into the subscriber line and 20mW into the back termination resistors, can be calculated as follows:

$$P_{DRIVER} = P_{TOT} - (P_{TERM} + P_{LINE}) \text{ where}$$

$P_{DRIVER}$  is the LMH6672 power dissipation

$P_{TOT}$  is the total power drawn from the power supply

$P_{TERM}$  is the power dissipated in the back termination resistors

$P_{LINE}$  is the power sent into the subscriber line

At full specified power,  $P_{TERM} = P_{LINE} = 20\text{mW}$ ,  $P_{TOT} = V_S \times I_S$ .

In this application,  $V_S = 12\text{V}$ .

$$I_S = I_Q + A_{VG} |I_{OUT}|.$$

$I_Q$  = the LMH6672 quiescent current minus the output stage idle current.

$$I_Q = 12.4 - 4.8 = 7.6\text{mA}$$

$A_{VG} |I_{OUT}|$  for a full-rate ADSL CPE application, using a 1:2 turns ratio transformer, is  $\sqrt{(40 \text{ mW}/50\Omega)} = 28.28\text{mA RMS}$ .

For a Gaussian signal, which the DMT ADSL signal approximates,  $A_{VG} |I_{OUT}| = \sqrt{2/\pi} \times I_{RMS} = 22.6\text{mA}$ . Therefore,  $P_{TOT} = (22.6\text{mA} + 7.6\text{mA}) \times 12\text{V} = 362\text{mW}$  and  $P_{DRIVER}$  is  $362 - 40 = 322\text{mW}$ .

In the SOIC package, with a  $\theta_{JA}$  of 172°C/W, this causes a temperature rise of 55°C. With an ambient temperature at the maximum recommended 85°C, the  $T_J$  is at 140°C, well below the specified 150°C maximum.

Even if we assume the absolute maximum  $I_S$  over temperature of 18mA, when we scale up the  $I_Q$  proportionally to 7mA, the  $P_{DRIVER}$  only goes up by 41mW causing a 62°C rise to 147°C.

Although very few CPE applications will ever operate in an environment as hot as 85°C, if a lower  $T_J$  is desired or the LMH6672 is to be used in an application where the power dissipation is higher, the PSOP package provides a much lower  $\theta_{JA}$  of only 58.6°C/W.

Using the same  $P_{DRIVER}$  as above, we find that the temperature rise is only 19° and 21°C, resulting in  $T_J$ 's in an 85°C ambient of 104°C and 106°C respectively.

### Circuit Layout Considerations

National Semiconductor suggests the following evaluation boards as a guide for high frequency layout and as an aid in device testing and characterization. Since the exposed PAD (or DAP) of the PSOP and LLP package is internally floating, the footprint for DAP could be connected to ground plane in PCB for better heat dissipation.

Device	Package	Evaluation Board PN
LMH6672MA	8-Pin SOIC	CLC730036
LMH6672LD	8-Pin LLP	CLC730114
LMH6672MR	8-Pin PSOP	CLC730121

These free evaluation boards are shipped when a device sample request is placed with National Semiconductor.

**Physical Dimensions** inches (millimeters)

unless otherwise noted

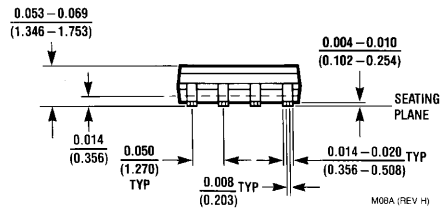
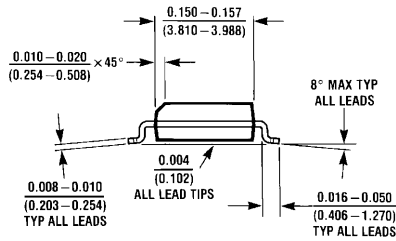
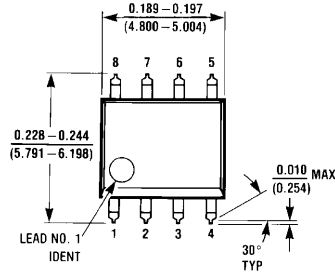

**8-Pin SOIC**  
**NS Package Number M08A**

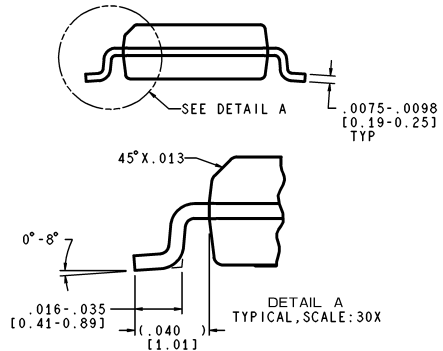
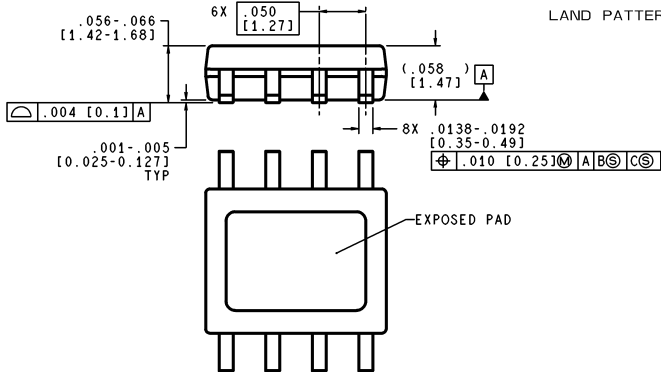
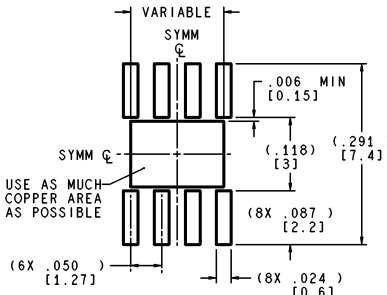
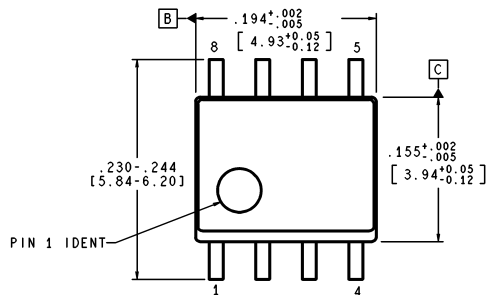

CONTROLLING DIMENSION IS INCH  
VALUES IN [ ] ARE MILLIMETERS

MRA08A (REV A)

**8-Pin PSOP**  
**NS Package Number MRA08A**

**Physical Dimensions** inches (millimeters) unless otherwise noted (Continued)

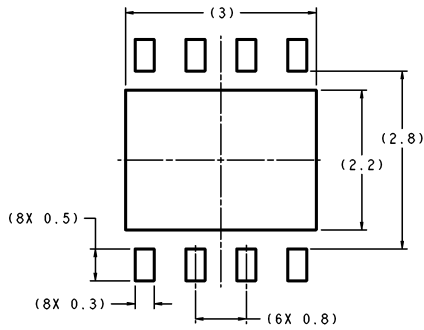

RECOMMENDED LAND PATTERN  
1:1 RATION WITH PKG SOLDER PADS

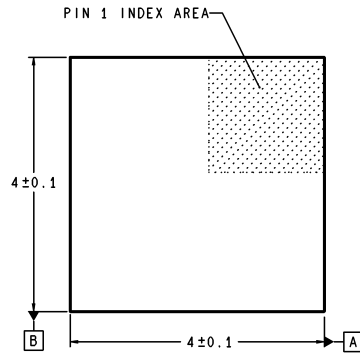

DIMENSIONS ARE IN MILLIMETERS

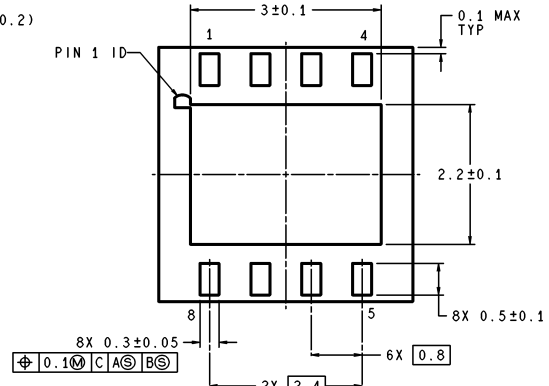
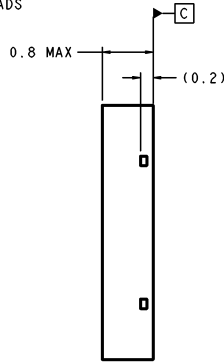

LDC08A (Rev A)

**8-Pin LLP**  
**NS Package Number LDC08A**

**LIFE SUPPORT POLICY**

NATIONAL'S PRODUCTS ARE NOT AUTHORIZED FOR USE AS CRITICAL COMPONENTS IN LIFE SUPPORT DEVICES OR SYSTEMS WITHOUT THE EXPRESS WRITTEN APPROVAL OF THE PRESIDENT AND GENERAL COUNSEL OF NATIONAL SEMICONDUCTOR CORPORATION. As used herein:

1. Life support devices or systems are devices or systems which, (a) are intended for surgical implant into the body, or (b) support or sustain life, and whose failure to perform when properly used in accordance with instructions for use provided in the labeling, can be reasonably expected to result in a significant injury to the user.
2. A critical component is any component of a life support device or system whose failure to perform can be reasonably expected to cause the failure of the life support device or system, or to affect its safety or effectiveness.



**National Semiconductor Corporation**  
Americas  
Email: support@nsc.com

www.national.com

**National Semiconductor Europe**  
Fax: +49 (0) 180-530 85 86  
Email: europe.support@nsc.com  
Deutsch Tel: +49 (0) 69 9508 6208  
English Tel: +44 (0) 870 24 0 2171  
Français Tel: +33 (0) 1 41 91 8790

**National Semiconductor Asia Pacific Customer Response Group**  
Tel: 65-2544466  
Fax: 65-2504466  
Email: ap.support@nsc.com

**National Semiconductor Japan Ltd.**  
Tel: 81-3-5639-7560  
Fax: 81-3-5639-7507