

# LMP7701/LMP7702/LMP7704

## Precision, CMOS Input, RRIO, Wide Supply Range Amplifiers

### General Description

The LMP7701/LMP7702/LMP7704 are single, dual, and quad low offset voltage, rail-to-rail input and output precision amplifiers each with CMOS input stage and wide supply voltage range. The LMP7701/LMP7702/LMP7704 are part of the LMP™ precision amplifier family and are ideal for sensor interface and other instrumentation applications.

The guaranteed low offset voltage of less than  $\pm 200 \mu\text{V}$  along with the guaranteed low input bias current of less than  $\pm 1 \text{ pA}$  make the LMP7701 ideal for precision applications. The LMP7701/LMP7702/LMP7704 are built utilizing VIP50 technology, which allows the combination of a CMOS input stage and a 12V common mode and supply voltage range. This makes the LMP7701/LMP7702/LMP7704 great choices in many applications where conventional CMOS parts cannot operate under the desired voltage conditions.

The LMP7701/LMP7702/LMP7704 have a rail-to-rail input stage that significantly reduces the CMRR glitch commonly associated with rail-to-rail input amplifiers. This is achieved by trimming both sides of the complimentary input stage, thereby reducing the difference between the NMOS and PMOS offsets. The output of the LMP7701/LMP7702/LMP7704 swings within 40 mV of either rail to maximize the signal dynamic range in applications requiring low supply voltage.

The LMP7701 is offered in the space saving 5-Pin SOT23 package, the LMP7702 is offered in the 8-Pin MSOP, and the quad LMP7704 is offered in the 14-Pin TSSOP package. These small packages are ideal solutions for area constrained PC boards and portable electronics.

### Features

Unless otherwise noted, typical values at  $V_S = 5\text{V}$

- Input offset voltage (LMP7701)  $\pm 200 \mu\text{V}$  (max)
- Input offset voltage (LMP7702/LMP7704)  $\pm 220 \mu\text{V}$  (max)
- Input bias current  $\pm 200 \text{ fA}$
- Input voltage noise  $9 \text{ nV}/\sqrt{\text{Hz}}$
- CMRR 130 dB
- Open loop gain 130 dB
- Temperature range  $-40^\circ\text{C}$  to  $125^\circ\text{C}$
- Unity gain bandwidth 2.5 MHz
- Supply current (LMP7701) 715  $\mu\text{A}$
- Supply current (LMP7702) 1.5 mA
- Supply current (LMP7704) 2.9 mA
- Supply voltage range 2.7V to 12V
- Rail-to-rail input and output

### Applications

- High impedance sensor interface
- Battery powered instrumentation
- High gain amplifiers
- DAC buffer
- Instrumentation amplifier
- Active filters

### Typical Application

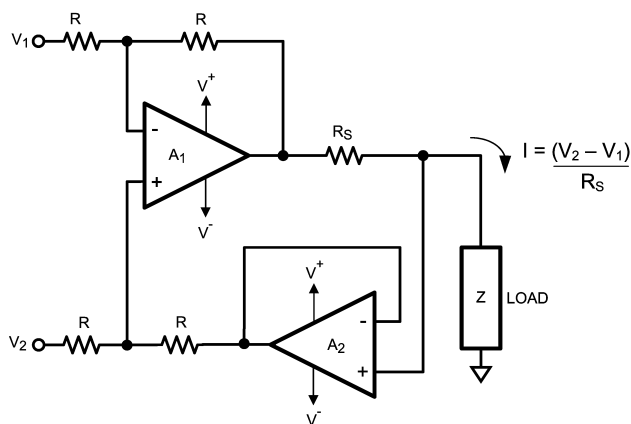

Precision Current Source

20127305

LMP™ is a trademark of National Semiconductor Corporation.

**Absolute Maximum Ratings** (Note 1)

If Military/Aerospace specified devices are required, please contact the National Semiconductor Sales Office/Distributors for availability and specifications.

ESD Tolerance (Note 2)	
Human Body Model	2000V
Machine Model	200V
$V_{IN}$ Differential	$\pm 300$ mV
Supply Voltage ( $V_S = V^+ - V^-$ )	13.2V
Voltage at Input/Output Pins	$V^+ + 0.3V, V^- - 0.3V$
Input Current	10 mA
Storage Temperature Range	$-65^\circ\text{C}$ to $+150^\circ\text{C}$
Junction Temperature (Note 3)	$+150^\circ\text{C}$

## Soldering Information

Infrared or Convection (20 sec)	$235^\circ\text{C}$
Wave Soldering Lead Temp. (10 sec)	$260^\circ\text{C}$

**Operating Ratings** (Note 1)

Temperature Range (Note 3)	$-40^\circ\text{C}$ to $+125^\circ\text{C}$
Supply Voltage ( $V_S = V^+ - V^-$ )	2.7V to 12V
Package Thermal Resistance ( $\theta_{JA}$ (Note 3))	
5-Pin SOT23	$265^\circ\text{C}/\text{W}$
8-Pin MSOP	$235^\circ\text{C}/\text{W}$
14-Pin TSSOP	$122^\circ\text{C}/\text{W}$

**3V Electrical Characteristics** (Note 4)

Unless otherwise specified, all limits are guaranteed for  $T_A = 25^\circ\text{C}$ ,  $V^+ = 3V$ ,  $V^- = 0V$ ,  $V_{CM} = V^+/2$ , and  $R_L > 10\text{ k}\Omega$  to  $V^+/2$ . **Boldface** limits apply at the temperature extremes.

Symbol	Parameter	Conditions	Min (Note 6)	Typ (Note 5)	Max (Note 6)	Units
$V_{OS}$	Input Offset Voltage	LMP7701		$\pm 37$	$\pm 200$ <b><math>\pm 500</math></b>	$\mu\text{V}$
		LMP7702/LMP7704		$\pm 56$	$\pm 220$ <b><math>\pm 520</math></b>	
$TCV_{OS}$	Input Offset Voltage Drift	(Note 7)		$\pm 1$	<b><math>\pm 5</math></b>	$\mu\text{V}/^\circ\text{C}$
$I_B$	Input Bias Current	(Notes 7, 8) $-40^\circ\text{C} \leq T_A \leq 85^\circ\text{C}$		$\pm 0.2$	$\pm 1$ <b><math>\pm 50</math></b>	pA
		(Notes 7, 8) $-40^\circ\text{C} \leq T_A \leq 125^\circ\text{C}$		$\pm 0.2$	$\pm 1$ <b><math>\pm 400</math></b>	
$I_{OS}$	Input Offset Current			40		fA
CMRR	Common Mode Rejection Ratio	$0V \leq V_{CM} \leq 3V$ LMP7701	86 <b>80</b>	130		dB
		$0V \leq V_{CM} \leq 3V$ LMP7702/LMP7704	84 <b>78</b>	130		
PSRR	Power Supply Rejection Ratio	$2.7V \leq V^+ \leq 12V, V_O = V^+/2$	86 <b>82</b>	98		dB
CMVR	Input Common-Mode Voltage Range	CMRR $\geq 80$ dB CMRR $\geq 77$ dB	$-0.2$ <b><math>-0.2</math></b>		3.2 <b>3.2</b>	V
$A_{VOL}$	Large Signal Voltage Gain	$R_L = 2\text{ k}\Omega$ (LMP7701) $V_O = 0.3V$ to $2.7V$	100 <b>96</b>	114		dB
		$R_L = 2\text{ k}\Omega$ (LMP7702/LMP7704) $V_O = 0.3V$ to $2.7V$	100 <b>94</b>	114		
		$R_L = 10\text{ k}\Omega$ $V_O = 0.2V$ to $2.8V$	100 <b>96</b>	124		

### 3V Electrical Characteristics (Note 4) (Continued)

Unless otherwise specified, all limits are guaranteed for  $T_A = 25^\circ\text{C}$ ,  $V^+ = 3\text{V}$ ,  $V^- = 0\text{V}$ ,  $V_{CM} = V^+/2$ , and  $R_L > 10\text{ k}\Omega$  to  $V^+/2$ .

**Boldface** limits apply at the temperature extremes.

Symbol	Parameter	Conditions	Min (Note 6)	Typ (Note 5)	Max (Note 6)	Units
$V_O$	Output Swing High	$R_L = 2\text{ k}\Omega$ to $V^+/2$ LMP7701		40	80 <b>120</b>	mV from $V^+$
		$R_L = 2\text{ k}\Omega$ to $V^+/2$ LMP7702/LMP7704		40	80 <b>150</b>	
		$R_L = 10\text{ k}\Omega$ to $V^+/2$ LMP7701		30	40 <b>60</b>	
		$R_L = 10\text{ k}\Omega$ to $V^+/2$ LMP7702/LMP7704		35	50 <b>100</b>	
	Output Swing Low	$R_L = 2\text{ k}\Omega$ to $V^+/2$ LMP7701		40	60 <b>80</b>	mV
		$R_L = 2\text{ k}\Omega$ to $V^+/2$ LMP7702/LMP7704		45	100 <b>170</b>	
		$R_L = 10\text{ k}\Omega$ to $V^+/2$ LMP7701		20	40 <b>50</b>	
		$R_L = 10\text{ k}\Omega$ to $V^+/2$ LMP7702/LMP7704		20	50 <b>90</b>	
$I_O$	Output Short Circuit Current (Notes 3, 9)	Sourcing $V_O = V^+/2$ $V_{IN} = 100\text{ mV}$	25 <b>15</b>	42		mA
		Sinking $V_O = V^+/2$ $V_{IN} = -100\text{ mV}$ (LMP7701)	25 <b>20</b>	42		
		Sinking $V_O = V^+/2$ $V_{IN} = -100\text{ mV}$ (LMP7702/LMP7704)	25 <b>15</b>	42		
$I_S$	Supply Current	LMP7701		0.670	1.0 <b>1.2</b>	mA
		LMP7702		1.4	1.8 <b>2.1</b>	
		LMP7704		2.9	3.5 <b>4.5</b>	
SR	Slew Rate (Note 10)	$A_V = +1$ , $V_O = 2\text{ V}_{PP}$ 10% to 90%		0.9		V/ $\mu\text{s}$
GBW	Gain Bandwidth Product			2.5		MHz
THD+N	Total Harmonic Distortion + Noise	$f = 1\text{ kHz}$ , $A_V = 1$ , $R_L = 10\text{ k}\Omega$		0.02		%
$e_n$	Input-Referred Voltage Noise	$f = 1\text{ kHz}$		9		nV/ $\sqrt{\text{Hz}}$
$i_n$	Input-Referred Current Noise	$f = 100\text{ kHz}$		1		fA/ $\sqrt{\text{Hz}}$

### 5V Electrical Characteristics (Note 4)

Unless otherwise specified, all limits are guaranteed for  $T_A = 25^\circ\text{C}$ ,  $V^+ = 5\text{V}$ ,  $V^- = 0\text{V}$ ,  $V_{CM} = V^+/2$ , and  $R_L > 10\text{ k}\Omega$  to  $V^+/2$ .

**Boldface** limits apply at the temperature extremes.

Symbol	Parameter	Conditions	Min (Note 6)	Typ (Note 5)	Max (Note 6)	Units
$V_{OS}$	Input Offset Voltage	LMP7701		$\pm 37$	$\pm 200$ <b><math>\pm 500</math></b>	$\mu\text{V}$
		LMP7702/LMP7704		$\pm 32$	$\pm 220$ <b><math>\pm 520</math></b>	
$TCV_{OS}$	Input Offset Voltage Drift	(Note 7)		$\pm 1$	<b><math>\pm 5</math></b>	$\mu\text{V}/^\circ\text{C}$

## 5V Electrical Characteristics (Note 4) (Continued)

Unless otherwise specified, all limits are guaranteed for  $T_A = 25^\circ\text{C}$ ,  $V^+ = 5\text{V}$ ,  $V^- = 0\text{V}$ ,  $V_{\text{CM}} = V^+/2$ , and  $R_L > 10\text{ k}\Omega$  to  $V^+/2$ . **Boldface** limits apply at the temperature extremes.

Symbol	Parameter	Conditions	Min (Note 6)	Typ (Note 5)	Max (Note 6)	Units	
$I_B$	Input Bias Current	(Notes 7, 8) $-40^\circ\text{C} \leq T_A \leq 85^\circ\text{C}$		$\pm 0.2$	$\pm 1$ <b><math>\pm 50</math></b>	$\mu\text{A}$	
		(Notes 7, 8) $-40^\circ\text{C} \leq T_A \leq 125^\circ\text{C}$		$\pm 0.2$	$\pm 1$ <b><math>\pm 400</math></b>		
$I_{\text{OS}}$	Input Offset Current			40		fA	
CMRR	Common Mode Rejection Ratio	$0\text{V} \leq V_{\text{CM}} \leq 5\text{V}$ LMP7701	88 <b>83</b>	130		dB	
		$0\text{V} \leq V_{\text{CM}} \leq 5\text{V}$ LMP7702/LMP7704	86 <b>81</b>	130			
PSRR	Power Supply Rejection Ratio	$2.7\text{V} \leq V^+ \leq 12\text{V}$ , $V_O = V^+/2$	86 <b>82</b>	100		dB	
CMVR	Input Common-Mode Voltage Range	CMRR $\geq 80$ dB CMRR $\geq 78$ dB	-0.2 <b>-0.2</b>		5.2 <b>5.2</b>	V	
$A_{\text{VOL}}$	Large Signal Voltage Gain	$R_L = 2\text{ k}\Omega$ (LMP7701) $V_O = 0.3\text{V}$ to $4.7\text{V}$	100 <b>96</b>	119		dB	
		$R_L = 2\text{ k}\Omega$ (LMP7702/LMP7704) $V_O = 0.3\text{V}$ to $4.7\text{V}$	100 <b>94</b>	119			
		$R_L = 10\text{ k}\Omega$ $V_O = 0.2\text{V}$ to $4.8\text{V}$	100 <b>96</b>	130			
$V_O$	Output Swing High	$R_L = 2\text{ k}\Omega$ to $V^+/2$ LMP7701		60	110 <b>130</b>	mV from $V^+$	
		$R_L = 2\text{ k}\Omega$ to $V^+/2$ LMP7702/LMP7704		60	120 <b>200</b>		
		$R_L = 10\text{ k}\Omega$ to $V^+/2$ LMP7701		40	50 <b>70</b>		
		$R_L = 10\text{ k}\Omega$ to $V^+/2$ LMP7702/LMP7704		40	60 <b>120</b>		
	Output Swing Low	$R_L = 2\text{ k}\Omega$ to $V^+/2$ LMP7701			50	80 <b>90</b>	mV
		$R_L = 2\text{ k}\Omega$ to $V^+/2$ LMP7702/LMP7704			50	120 <b>190</b>	
		$R_L = 10\text{ k}\Omega$ to $V^+/2$ LMP7701			30	40 <b>50</b>	
		$R_L = 10\text{ k}\Omega$ to $V^+/2$ LMP7702/LMP7704			30	50 <b>100</b>	
$I_O$	Output Short Circuit Current (Notes 3, 9)	Sourcing $V_O = V^+/2$ $V_{\text{IN}} = 100\text{ mV}$ (LMP7701)	40 <b>28</b>	66		mA	
		Sourcing $V_O = V^+/2$ $V_{\text{IN}} = 100\text{ mV}$ (LMP7702/LMP7704)	38 <b>25</b>	66			
		Sinking $V_O = V^+/2$ $V_{\text{IN}} = -100\text{ mV}$ (LMP7701)	40 <b>28</b>	76			
		Sinking $V_O = V^+/2$ $V_{\text{IN}} = -100\text{ mV}$ (LMP7702/LMP7704)	40 <b>23</b>	76			

**5V Electrical Characteristics** (Note 4) (Continued)

Unless otherwise specified, all limits are guaranteed for  $T_A = 25^\circ\text{C}$ ,  $V^+ = 5\text{V}$ ,  $V^- = 0\text{V}$ ,  $V_{CM} = V^+/2$ , and  $R_L > 10\text{ k}\Omega$  to  $V^+/2$ .

**Boldface** limits apply at the temperature extremes.

Symbol	Parameter	Conditions	Min (Note 6)	Typ (Note 5)	Max (Note 6)	Units
$I_S$	Supply Current	LMP7701		0.715	1.0 <b>1.2</b>	mA
		LMP7702		1.5	1.9 <b>2.2</b>	
		LMP7704		2.9	3.7 <b>4.6</b>	
SR	Slew Rate (Note 10)	$A_V = +1$ , $V_O = 4 V_{PP}$ 10% to 90%		1.0		V/ $\mu\text{s}$
GBW	Gain Bandwidth Product			2.5		MHz
THD+N	Total Harmonic Distortion + Noise	$f = 1\text{ kHz}$ , $A_V = 1$ , $R_L = 10\text{ k}\Omega$		0.02		%
$e_n$	Input-Referred Voltage Noise	$f = 1\text{ kHz}$		9		nV/ $\sqrt{\text{Hz}}$
$i_n$	Input-Referred Current Noise	$f = 100\text{ kHz}$		1		fA/ $\sqrt{\text{Hz}}$

 **$\pm 5\text{V}$  Electrical Characteristics** (Note 4)

Unless otherwise specified, all limits are guaranteed for  $T_A = 25^\circ\text{C}$ ,  $V^+ = 5\text{V}$ ,  $V^- = -5\text{V}$ ,  $V_{CM} = 0\text{V}$ , and  $R_L > 10\text{ k}\Omega$  to  $0\text{V}$ .

**Boldface** limits apply at the temperature extremes.

Symbol	Parameter	Conditions	Min (Note 6)	Typ (Note 5)	Max (Note 6)	Units
$V_{OS}$	Input Offset Voltage	LMP7701		$\pm 37$	$\pm 200$ <b><math>\pm 500</math></b>	$\mu\text{V}$
		LMP7702/LMP7704		$\pm 37$	$\pm 220$ <b><math>\pm 520</math></b>	
$TCV_{OS}$	Input Offset Voltage Drift	(Note 7)		$\pm 1$	<b><math>\pm 5</math></b>	$\mu\text{V}/^\circ\text{C}$
$I_B$	Input Bias Current	(Notes 7, 8) $-40^\circ\text{C} \leq T_A \leq 85^\circ\text{C}$		$\pm 0.2$	1 <b><math>\pm 50</math></b>	pA
		(Notes 7, 8) $-40^\circ\text{C} \leq T_A \leq 125^\circ\text{C}$		$\pm 0.2$	1 <b><math>\pm 400</math></b>	
$I_{OS}$	Input Offset Current			40		fA
CMRR	Common Mode Rejection Ratio	$-5\text{V} \leq V_{CM} \leq 5\text{V}$ LMP7701	92 <b>88</b>	138		dB
		$-5\text{V} \leq V_{CM} \leq 5\text{V}$ LMP7702/LMP7704	90 <b>86</b>	138		
PSRR	Power Supply Rejection Ratio	$2.7\text{V} \leq V^+ \leq 12\text{V}$ , $V_O = 0\text{V}$	86 <b>82</b>	98		dB
CMVR	Input Common-Mode Voltage Range	CMRR $\geq 80\text{ dB}$ CMRR $\geq 78\text{ dB}$	-5.2 <b>-5.2</b>		5.2 <b>5.2</b>	V
$A_{VOL}$	Large Signal Voltage Gain	$R_L = 2\text{ k}\Omega$ (LMP7701) $V_O = -4.7\text{V}$ to $4.7\text{V}$	100 <b>98</b>	121		dB
		$R_L = 2\text{ k}\Omega$ (LMP7702/LMP7704) $V_O = -4.7\text{V}$ to $4.7\text{V}$	100 <b>94</b>	121		
		$R_L = 10\text{ k}\Omega$ (LMP7701) $V_O = -4.8\text{V}$ to $4.8\text{V}$	100 <b>98</b>	134		
		$R_L = 10\text{ k}\Omega$ (LMP7702/LMP7704) $V_O = -4.8\text{V}$ to $4.8\text{V}$	100 <b>97</b>	134		

**±5V Electrical Characteristics** (Note 4) (Continued)

Unless otherwise specified, all limits are guaranteed for  $T_A = 25^\circ\text{C}$ ,  $V^+ = 5\text{V}$ ,  $V^- = -5\text{V}$ ,  $V_{CM} = 0\text{V}$ , and  $R_L > 10\text{ k}\Omega$  to  $0\text{V}$ . **Boldface** limits apply at the temperature extremes.

Symbol	Parameter	Conditions	Min (Note 6)	Typ (Note 5)	Max (Note 6)	Units	
$V_O$	Output Swing High	$R_L = 2\text{ k}\Omega$ to $0\text{V}$ LMP7701		90	150 <b>170</b>	mV from $V^+$	
		$R_L = 2\text{ k}\Omega$ to $0\text{V}$ LMP7702/LMP7704		90	180 <b>290</b>		
		$R_L = 10\text{ k}\Omega$ to $0\text{V}$ LMP7701		40	80 <b>100</b>		
		$R_L = 10\text{ k}\Omega$ to $0\text{V}$ LMP7702/LMP7704		40	80 <b>150</b>		
	Output Swing Low	$R_L = 2\text{ k}\Omega$ to $0\text{V}$ LMP7701			90	130 <b>150</b>	mV from $V^-$
		$R_L = 2\text{ k}\Omega$ to $0\text{V}$ LMP7702/LMP7704			90	180 <b>290</b>	
		$R_L = 10\text{ k}\Omega$ to $0\text{V}$ LMP7701			40	50 <b>60</b>	
		$R_L = 10\text{ k}\Omega$ to $0\text{V}$ LMP7702/LMP7704			40	60 <b>110</b>	
$I_O$	Output Short Circuit Current (Notes 3, 9)	Sourcing $V_O = 0\text{V}$ $V_{IN} = 100\text{ mV}$ (LMP7701)	50 <b>35</b>	86		mA	
		Sourcing $V_O = 0\text{V}$ $V_{IN} = 100\text{ mV}$ (LMP7702/LMP7704)	48 <b>33</b>	86			
		Sinking $V_O = 0\text{V}$ $V_{IN} = -100\text{ mV}$	50 <b>35</b>	84			
$I_S$	Supply Current	LMP7701		0.790	1.1 <b>1.3</b>	mA	
		LMP7702		1.7	2.1 <b>2.5</b>		
		LMP7704		3.2	4.2 <b>5.0</b>		
SR	Slew Rate (Note 10)	$A_V = +1$ , $V_O = 9\text{ V}_{PP}$ 10% to 90%		1.1		V/ $\mu\text{s}$	
GBW	Gain Bandwidth Product			2.5		MHz	
THD+N	Total Harmonic Distortion + Noise	$f = 1\text{ kHz}$ , $A_V = 1$ , $R_L = 10\text{ k}\Omega$		0.02		%	
$e_n$	Input-Referred Voltage Noise	$f = 1\text{ kHz}$		9		nV/ $\sqrt{\text{Hz}}$	
$i_n$	Input-Referred Current Noise	$f = 100\text{ kHz}$		1		fA/ $\sqrt{\text{Hz}}$	

**Note 1:** Absolute Maximum Ratings indicate limits beyond which damage to the device may occur. Operating Ratings indicate conditions for which the device is intended to be functional, but specific performance is not guaranteed. For guaranteed specifications and the test conditions, see the Electrical Characteristics Tables.

**Note 2:** Human Body Model is  $1.5\text{ k}\Omega$  in series with  $100\text{ pF}$ . Machine Model is  $0\Omega$  in series with  $200\text{ pF}$ .

**Note 3:** The maximum power dissipation is a function of  $T_{J(\text{MAX})}$ ,  $\theta_{JA}$ , and  $T_A$ . The maximum allowable power dissipation at any ambient temperature is  $P_D = (T_{J(\text{MAX})} - T_A) / \theta_{JA}$ . All numbers apply for packages soldered directly onto a PC board.

**Note 4:** Electrical table values apply only for factory testing conditions at the temperature indicated. Factory testing conditions result in very limited self-heating of the device.

**Note 5:** Typical values represent the parametric norm at the time of characterization.

**Note 6:** Limits are 100% production tested at  $25^\circ\text{C}$ . Limits over the operating temperature range are guaranteed through correlations using the Statistical Quality Control (SQC) method.

**Note 7:** Guaranteed by design.

**Note 8:** Positive current corresponds to current flowing into the device.

**Note 9:** The short circuit test is a momentary test.

**Note 10:** The number specified is the slower of positive and negative slew rates.

## Connection Diagrams

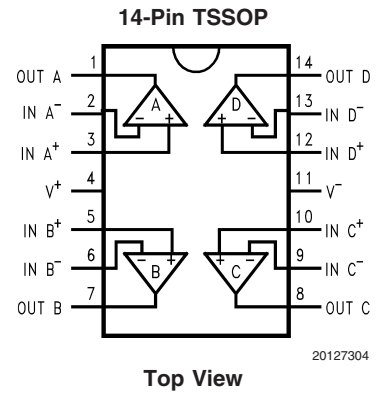
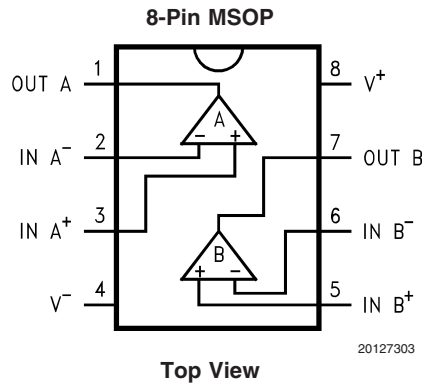
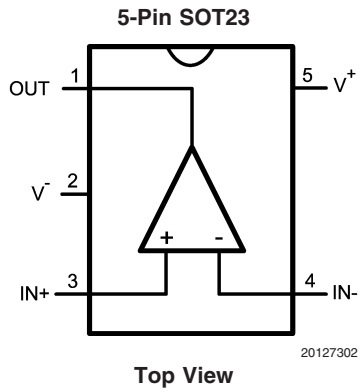

## Ordering Information

Package	Part Number	Package Marking	Transport Media	NSC Drawing
5-Pin SOT23	LMP7701MF	AC2A	1k Units Tape and Reel	MF05A
	LMP7701MFX		3k Units Tape and Reel	
8-Pin MSOP	LMP7702MM	AA3A	1k Units Tape and Reel	MUA08A
	LMP7702MMX		3.5k Units Tape and Reel	
14-Pin TSSOP	LMP7704MT	LMP7704MT	94 Units/Rail	MTC14
	LMP7704MTX		2.5k Units Tape and Reel	

**Typical Performance Characteristics** Unless otherwise noted:  $T_A = 25^\circ\text{C}$ ,  $V_{CM} = V_S/2$ ,  $R_L > 10\text{ k}\Omega$ .

**Offset Voltage Distribution**

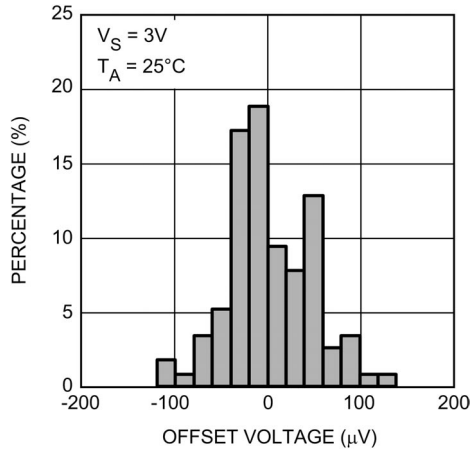

20127336

**TCV<sub>OS</sub> Distribution**

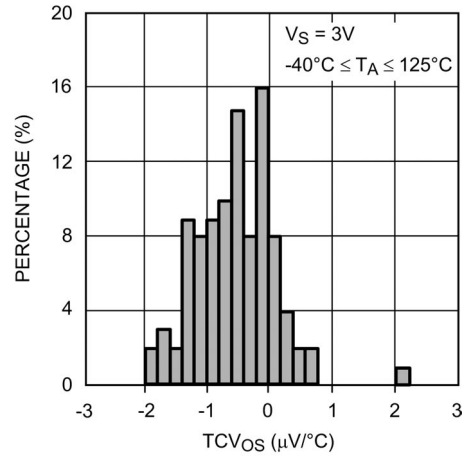

20127341

**Offset Voltage Distribution**

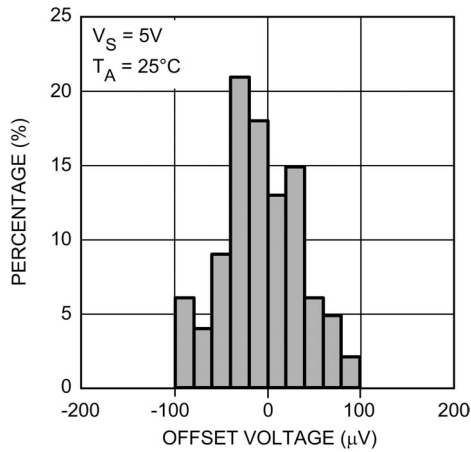

20127337

**TCV<sub>OS</sub> Distribution**

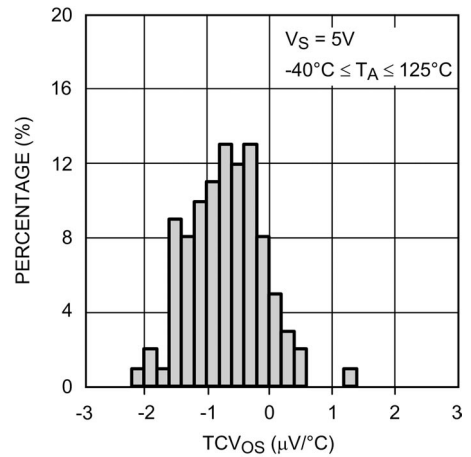

20127342

**Offset Voltage Distribution**

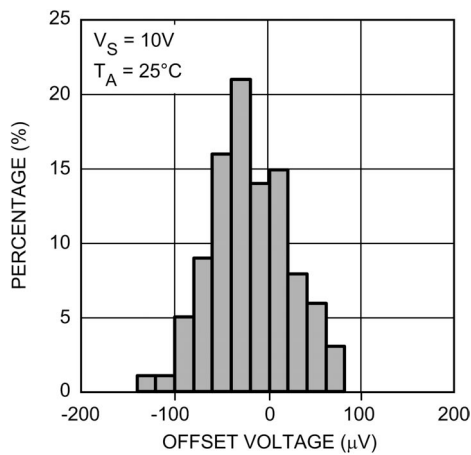

20127338

**TCV<sub>OS</sub> Distribution**

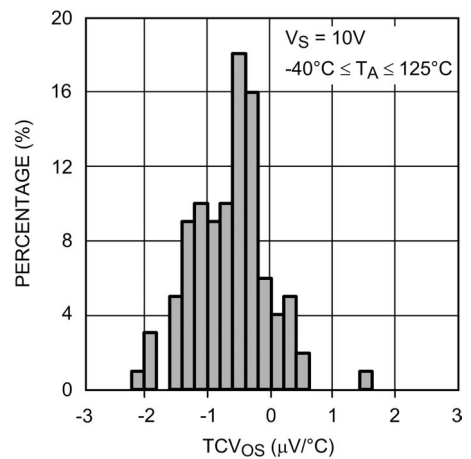

20127343



# Typical Performance Characteristics

Unless otherwise noted:  $T_A = 25^\circ\text{C}$ ,  $V_{CM} = V_S/2$ ,  $R_L > 10\text{ k}\Omega$ .

(Continued)

**Offset Voltage vs. Temperature**

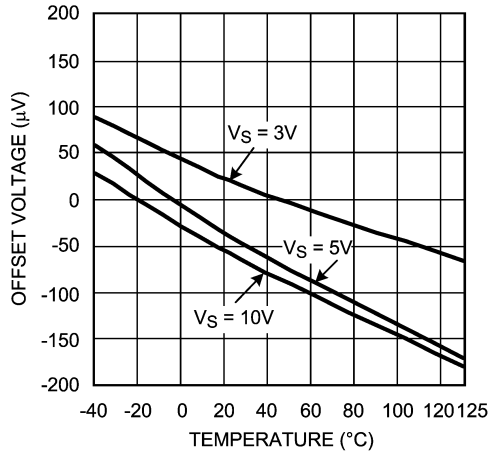

20127306

**CMRR vs Frequency**

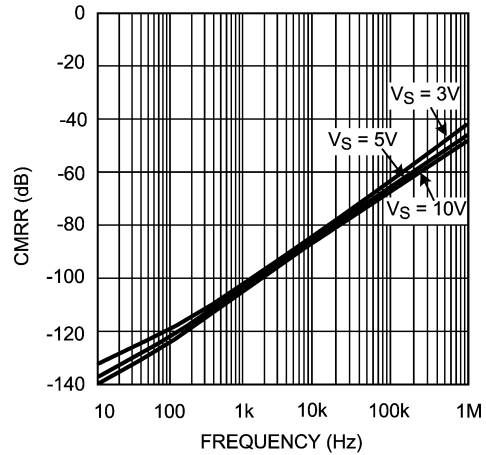

20127350

**Offset Voltage vs. Supply Voltage**

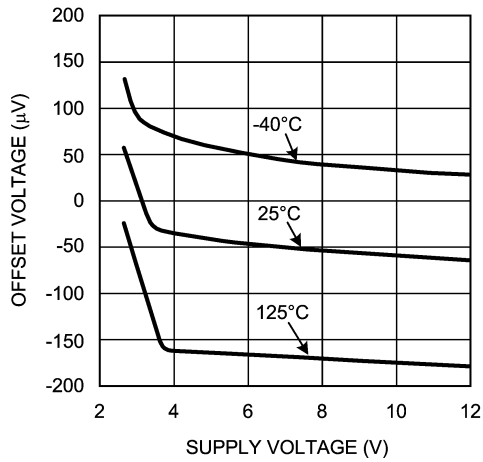

20127310

**Offset Voltage vs.  $V_{CM}$**

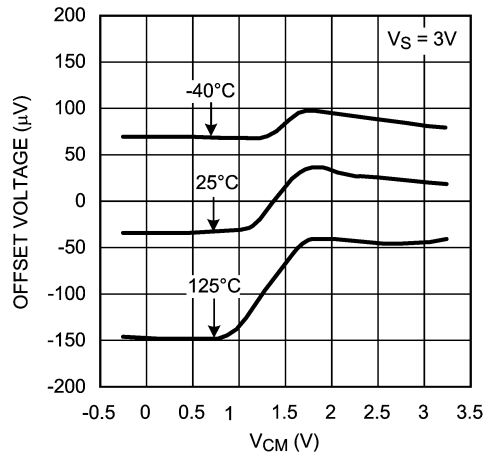

20127307

**Offset Voltage vs.  $V_{CM}$**

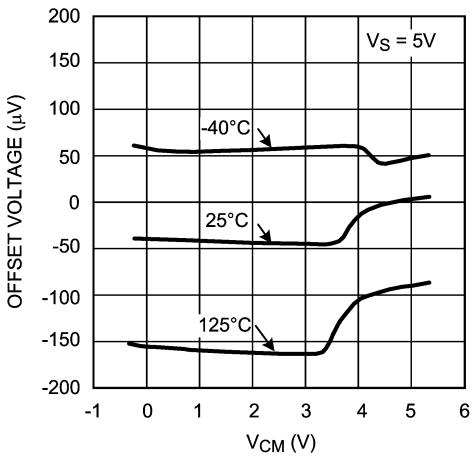

20127308

**Offset Voltage vs.  $V_{CM}$**

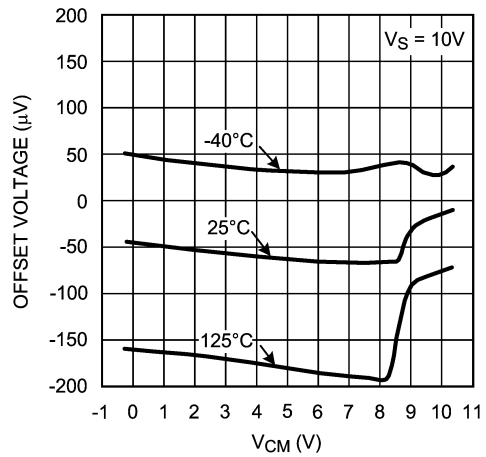

20127309

**Typical Performance Characteristics** Unless otherwise noted:  $T_A = 25^\circ\text{C}$ ,  $V_{CM} = V_S/2$ ,  $R_L > 10\text{ k}\Omega$ .

(Continued)

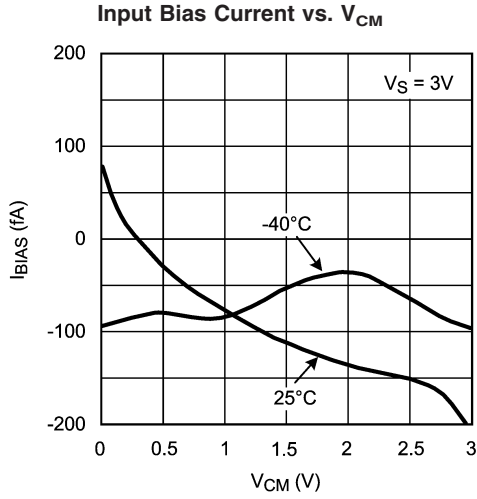

20127346

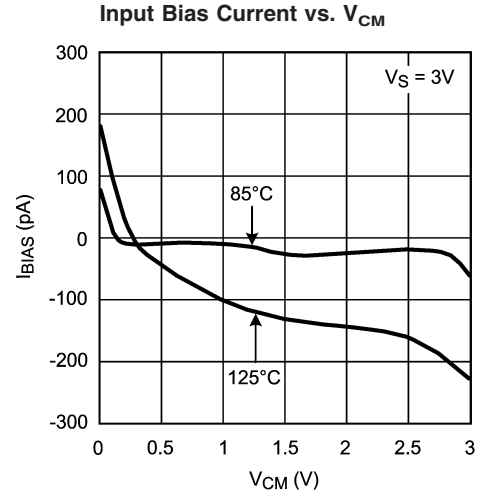

20127330

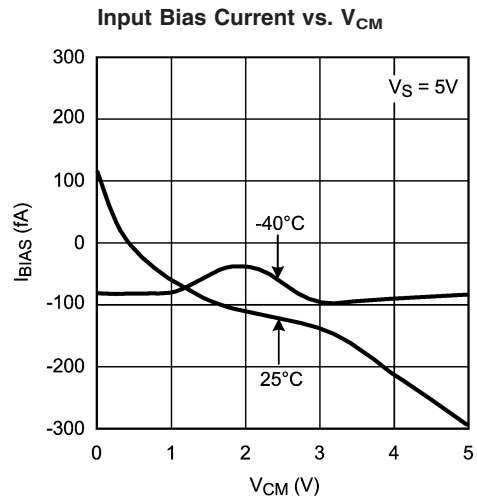

20127347

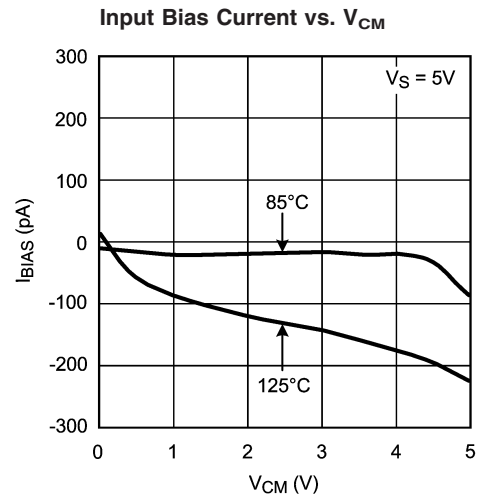

20127331

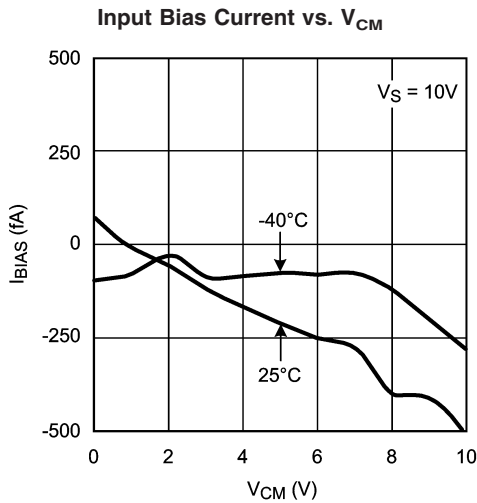

20127348

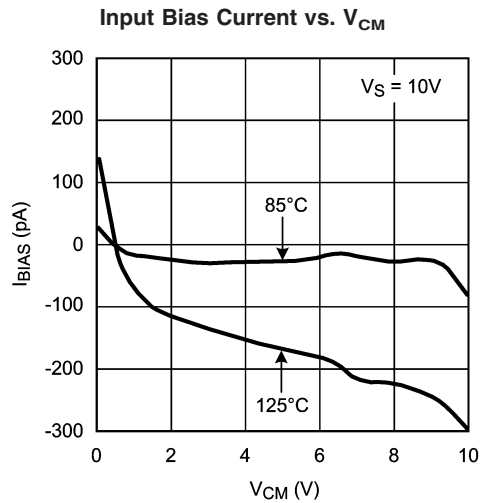

20127349

**Typical Performance Characteristics** Unless otherwise noted:  $T_A = 25^\circ\text{C}$ ,  $V_{CM} = V_S/2$ ,  $R_L > 10\text{ k}\Omega$ .  
 (Continued)

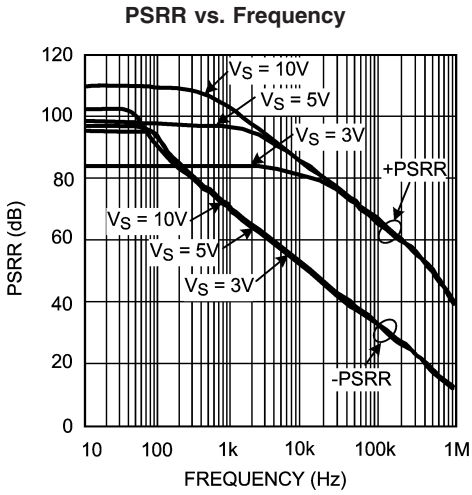

20127345

**Supply Current vs. Supply Voltage (Per Channel)**

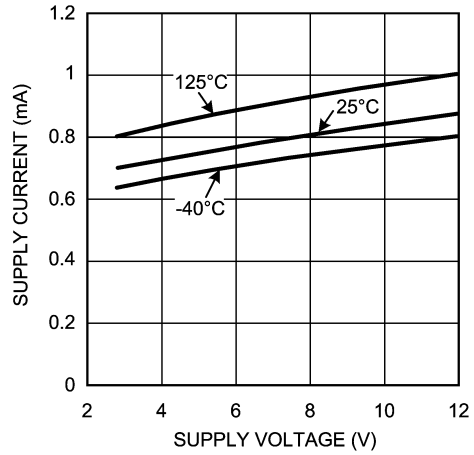

20127311

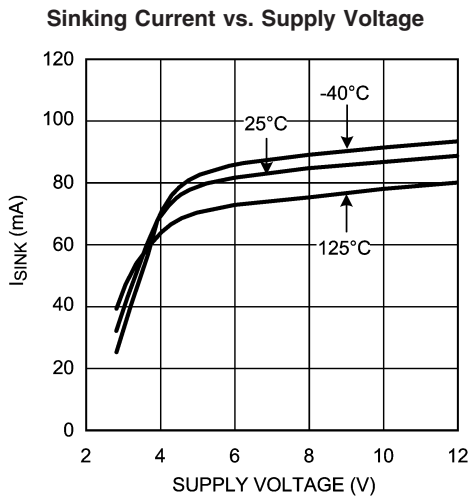

20127313

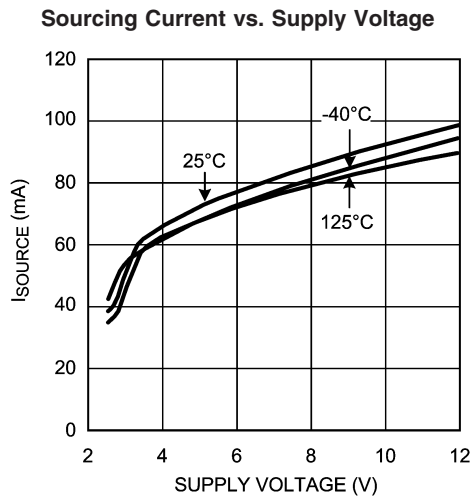

20127312

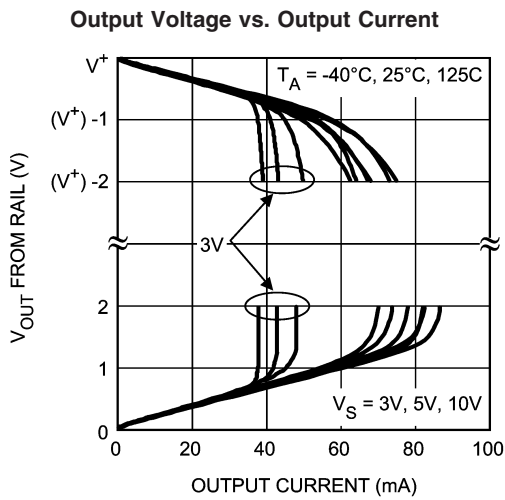

20127316

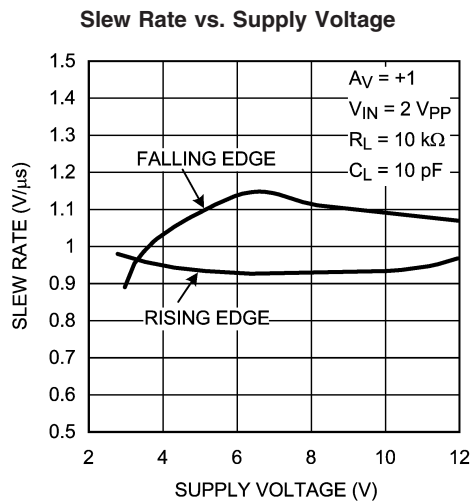

20127317

# Typical Performance Characteristics

(Continued)

Unless otherwise noted:  $T_A = 25^\circ\text{C}$ ,  $V_{CM} = V_S/2$ ,  $R_L > 10\text{ k}\Omega$ .

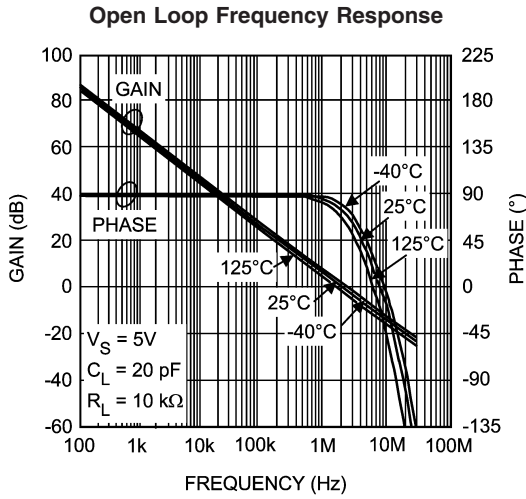

20127315

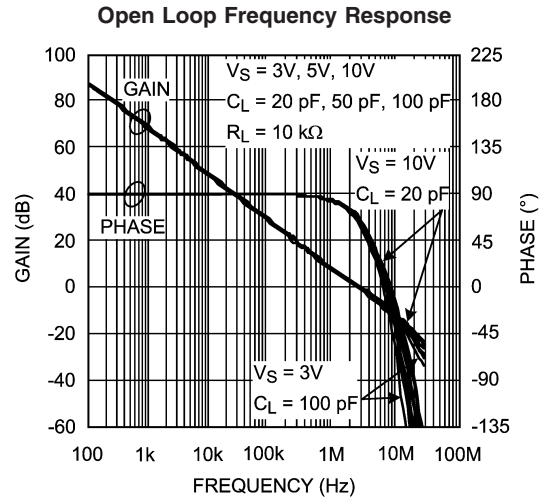

20127314

### Large Signal Step Response

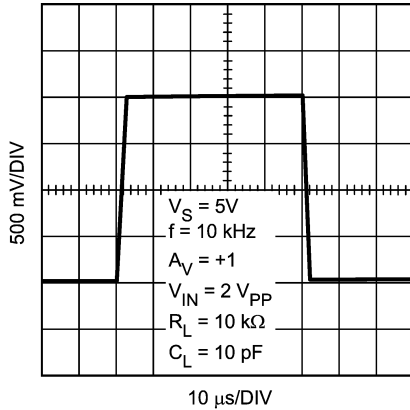

20127318

### Small Signal Step Response

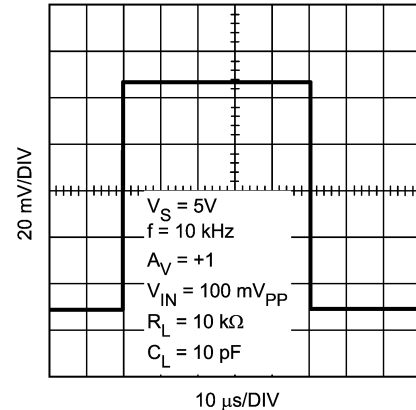

20127320

### Large Signal Step Response

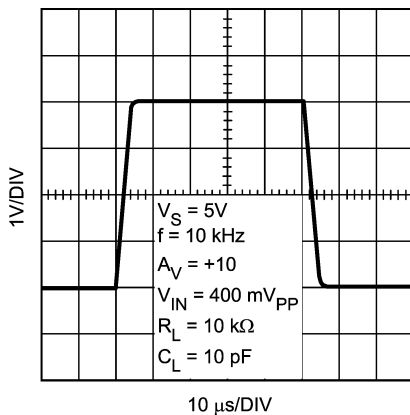

20127319

### Small Signal Step Response

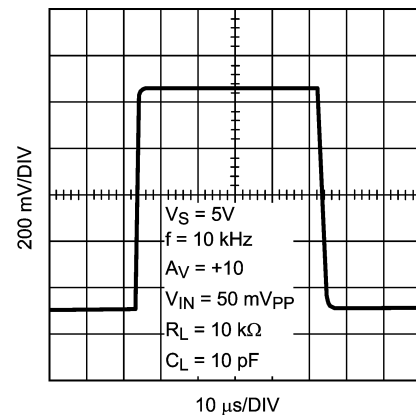

20127326

# Typical Performance Characteristics

Unless otherwise noted:  $T_A = 25^\circ\text{C}$ ,  $V_{CM} = V_S/2$ ,  $R_L > 10\text{ k}\Omega$ .

(Continued)

**Input Voltage Noise vs. Frequency**

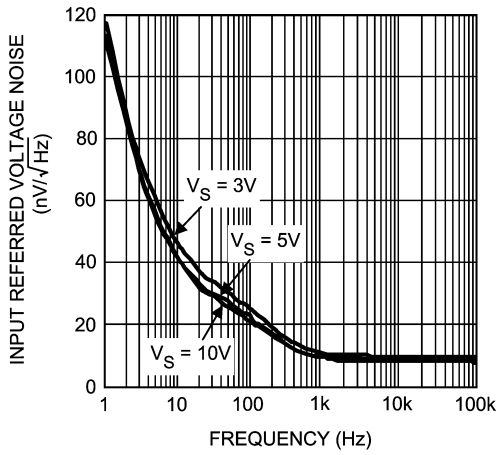

20127327

**Open Loop Gain vs. Output Voltage Swing**

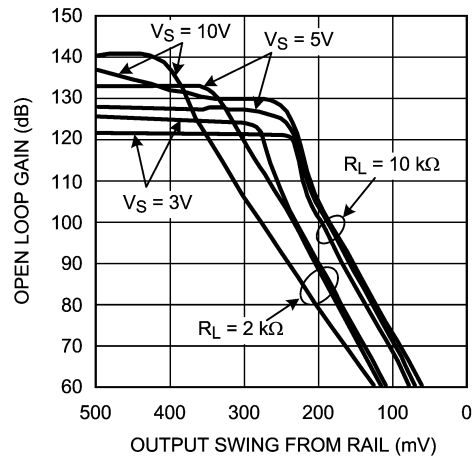

20127352

**Output Swing High vs. Supply Voltage**

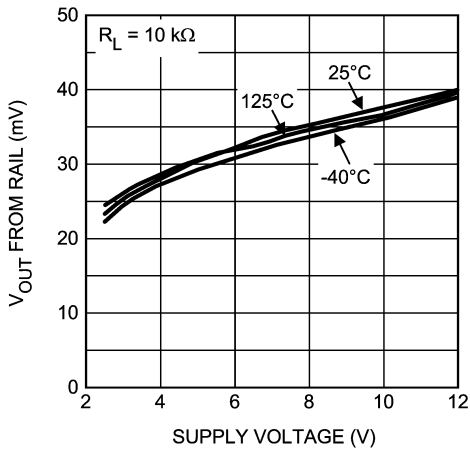

20127333

**Output Swing Low vs. Supply Voltage**

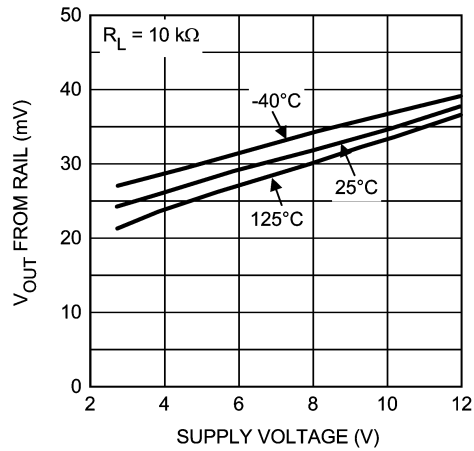

20127335

**Output Swing High vs. Supply Voltage**

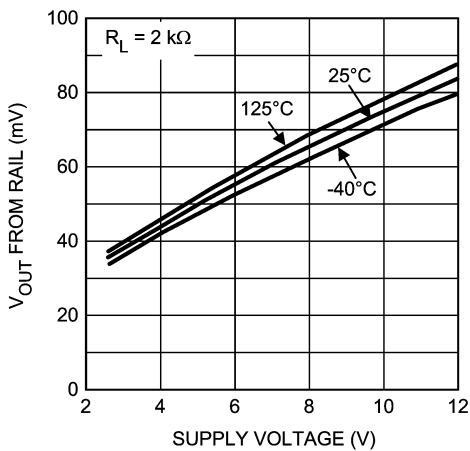

20127332

**Output Swing Low vs. Supply Voltage**

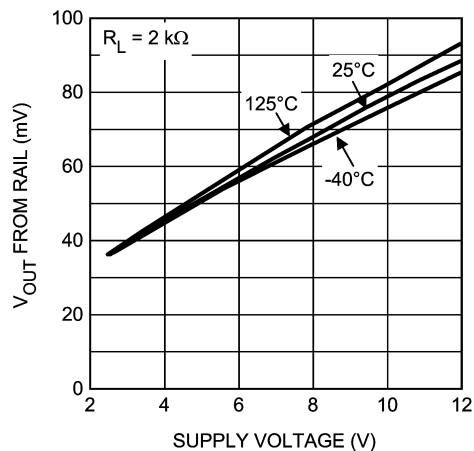

20127334

# Typical Performance Characteristics

Unless otherwise noted:  $T_A = 25^\circ\text{C}$ ,  $V_{CM} = V_S/2$ ,  $R_L > 10\text{ k}\Omega$ .

(Continued)

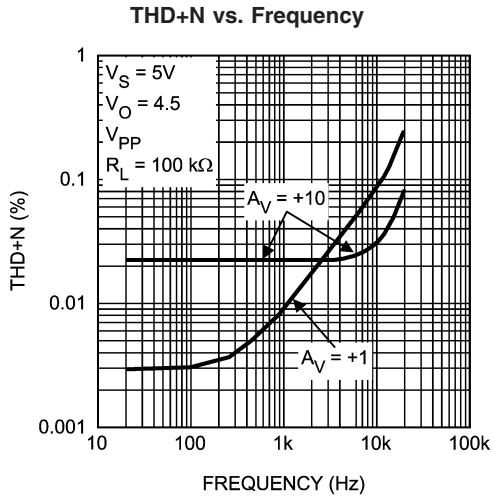

20127328

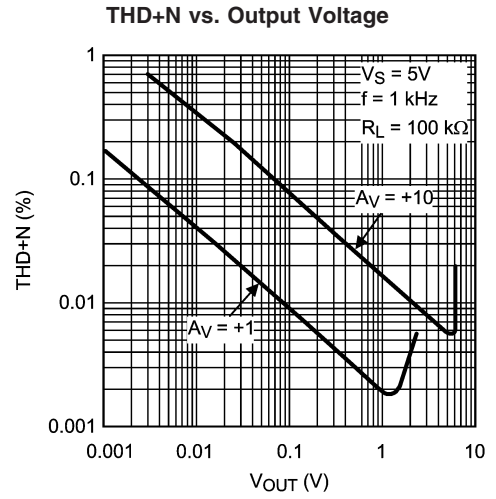

20127329

### Crosstalk Rejection Ratio vs. Frequency (LMP7702/LMP7704)

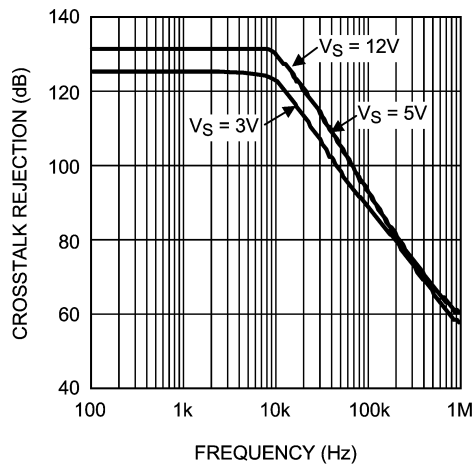

20127353

## Application Information

### LMP7701/LMP7702/LMP7704

The LMP7701/LMP7702/LMP7704 are single, dual, and quad low offset voltage, rail-to-rail input and output precision amplifiers each with CMOS input stage and wide supply voltage range of 2.7V to 12V. The LMP7701/LMP7702/LMP7704 have a very low input bias current of only  $\pm 200$  fA at room temperature.

The wide supply voltage range of 2.7V to 12V over the extensive temperature range of  $-40^{\circ}\text{C}$  to  $125^{\circ}\text{C}$  makes the LMP7701/LMP7702/LMP7704 excellent choices for low voltage precision applications with extensive temperature requirements.

The LMP7701/LMP7702/LMP7704 have only  $\pm 37$   $\mu\text{V}$  of typical input referred offset voltage and this offset is guaranteed to be less than  $\pm 500$   $\mu\text{V}$  for the single and  $\pm 520$   $\mu\text{V}$  for the dual and quad, over temperature. This minimal offset voltage allows more accurate signal detection and amplification in precision applications.

The low input bias current of only  $\pm 200$  fA along with the low input referred voltage noise of  $9$   $\text{nV}/\sqrt{\text{Hz}}$  give the LMP7701/LMP7702/LMP7704 superiority for use in sensor applications. Lower levels of noise introduced by the amplifier mean better signal fidelity and a higher signal-to-noise ratio.

National Semiconductor is heavily committed to precision amplifiers and the market segment they serve. Technical support and extensive characterization data is available for sensitive applications or applications with a constrained error budget.

The LMP7701 is offered in the space saving 5-Pin SOT23 package, the LMP7702 comes in the 8-pin MSOP, and the LMP7704 is offered in the 14-Pin TSSOP package. These small packages are ideal solutions for area constrained PC boards and portable electronics.

### CAPACITIVE LOAD

The LMP7701/LMP7702/LMP7704 can each be connected as a non-inverting unity gain follower. This configuration is the most sensitive to capacitive loading.

The combination of a capacitive load placed on the output of an amplifier along with the amplifier's output impedance creates a phase lag which in turn reduces the phase margin of the amplifier. If the phase margin is significantly reduced, the response will be either underdamped or it will oscillate.

In order to drive heavier capacitive loads, an isolation resistor,  $R_{\text{ISO}}$ , in *Figure 1* should be used. By using this isolation resistor, the capacitive load is isolated from the amplifier's output, and hence, the pole caused by  $C_L$  is no longer in the feedback loop. The larger the value of  $R_{\text{ISO}}$ , the more stable the output voltage will be. If values of  $R_{\text{ISO}}$  are sufficiently large, the feedback loop will be stable, independent of the value of  $C_L$ . However, larger values of  $R_{\text{ISO}}$  result in reduced output swing and reduced output current drive.

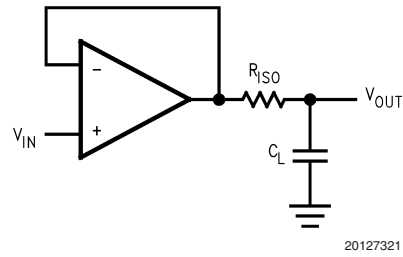

20127321

FIGURE 1. Isolating Capacitive Load

### INPUT CAPACITANCE

CMOS input stages inherently have low input bias current and higher input referred voltage noise. The LMP7701/LMP7702/LMP7704 enhance this performance by having the low input bias current of only  $\pm 200$  fA, as well as, a very low input referred voltage noise of  $9$   $\text{nV}/\sqrt{\text{Hz}}$ . In order to achieve this a larger input stage has been used. This larger input stage increases the input capacitance of the LMP7701/LMP7702/LMP7704. The typical value of this input capacitance,  $C_{\text{IN}}$ , for the LMP7701/LMP7702/LMP7704 is 25 pF. The input capacitance will interact with other impedances such as gain and feedback resistors, which are seen on the inputs of the amplifier, to form a pole. This pole will have little or no effect on the output of the amplifier at low frequencies and DC conditions, but will play a bigger role as the frequency increases. At higher frequencies, the presence of this pole will decrease phase margin and will also cause gain peaking. In order to compensate for the input capacitance, care must be taken in choosing the feedback resistors. In addition to being selective in picking values for the feedback resistor, a capacitor can be added to the feedback path to increase stability.

The DC gain of the circuit shown in *Figure 2* is simply  $-R_2/R_1$ .

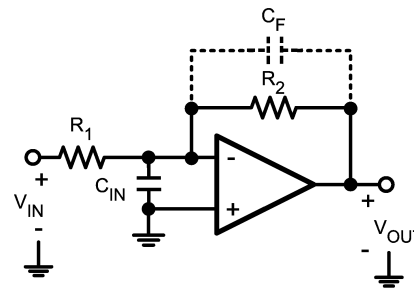

20127344

FIGURE 2. Compensating for Input Capacitance

For the time being, ignore  $C_F$ . The AC gain of the circuit in *Figure 2* can be calculated as follows:

$$A_V = - \frac{V_{\text{OUT}}}{V_{\text{IN}}} = - \frac{R_2}{R_1}$$

## Application Information (Continued)

$$\frac{V_{OUT}}{V_{IN}}(s) = \frac{-R_2/R_1}{\left[ 1 + \frac{s}{\left( \frac{A_0 R_1}{R_1 + R_2} \right)} + \frac{s^2}{\left( \frac{A_0}{C_{IN} R_2} \right)} \right]}$$

This equation is rearranged to find the location of the two poles:

$$P_{1,2} = \frac{-1}{2C_{IN}} \left[ \frac{1}{R_1} + \frac{1}{R_2} \pm \sqrt{\left( \frac{1}{R_1} + \frac{1}{R_2} \right)^2 - \frac{4 A_0 C_{IN}}{R_2}} \right] \quad (1)$$

As shown in *Equation (1)*, as values of  $R_1$  and  $R_2$  are increased, the magnitude of the poles is reduced, which in turn decreases the bandwidth of the amplifier. Whenever possible, it is best to choose smaller feedback resistors. *Figure 3* shows the effect of feedback resistor on the LMP7701/LMP7702/LMP7704 bandwidth.

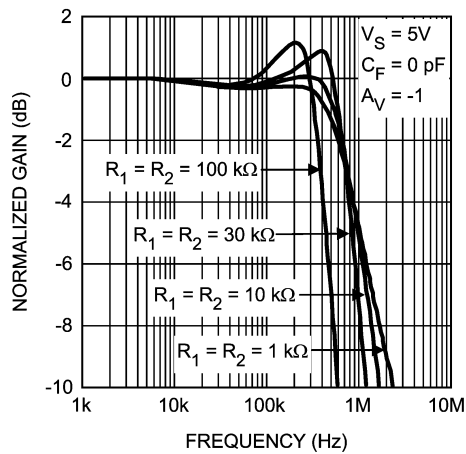

FIGURE 3. Closed Loop Gain vs. Frequency

*Equation (1)* has two poles. In most cases, it is the presence of pairs of poles that causes gain peaking. In order to eliminate this effect, the poles should be placed in Butterworth position, since poles in Butterworth position do not cause gain peaking. To achieve a Butterworth pair, the quantity under the square root in *Equation (1)* should be set to equal  $-1$ . Using this fact and the relation between  $R_1$  and  $R_2$ ,  $R_2 = -A_V R_1$ , the optimum value for  $R_1$  can be found. This is shown in *Equation (2)*. If  $R_1$  is chosen to be larger than this optimum value, gain peaking will occur.

$$R_1 < \frac{(1 - A_V)^2}{2A_0 A_V C_{IN}} \quad (2)$$

In *Figure 2*,  $C_F$  is added to compensate for input capacitance and to increase stability. Additionally,  $C_F$  reduces or elimi-

nates the gain peaking that can be caused by having a larger feedback resistor. *Figure 4* shows how  $C_F$  reduces gain peaking.

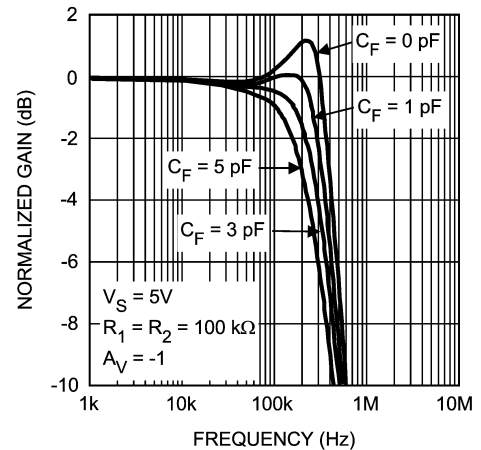

FIGURE 4. Closed Loop Gain vs. Frequency with Compensation

### DIODES BETWEEN THE INPUTS

The LMP7701/LMP7702/LMP7704 have a set of anti-parallel diodes between the input pins, as shown in *Figure 5*. These diodes are present to protect the input stage of the amplifier. At the same time, they limit the amount of differential input voltage that is allowed on the input pins. A differential signal larger than one diode voltage drop might damage the diodes. The differential signal between the inputs needs to be limited to  $\pm 300$  mV or the input current needs to be limited to  $\pm 10$  mA.

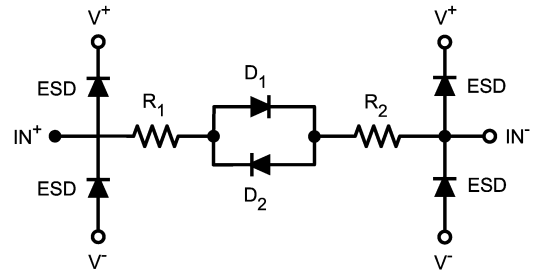

FIGURE 5. Input of LMP7701



## Application Information (Continued)

### PRECISION CURRENT SOURCE

The LMP7701/LMP7702/LMP7704 can each be used as a precision current source in many different applications. *Figure 6* shows a typical precision current source. This circuit implements a precision voltage controlled current source. Amplifier A1 is a differential amplifier that uses the voltage drop across  $R_S$  as the feedback signal. Amplifier A2 is a buffer that eliminates the error current from the load side of the  $R_S$  resistor that would flow in the feedback resistor if it were connected to the load side of the  $R_S$  resistor. In general, the circuit is stable as long as the closed loop bandwidth of amplifier A2 is greater than the closed loop bandwidth of amplifier A1. Note that if A1 and A2 are the same type of amplifiers, then the feedback around A1 will reduce its bandwidth compared to A2.

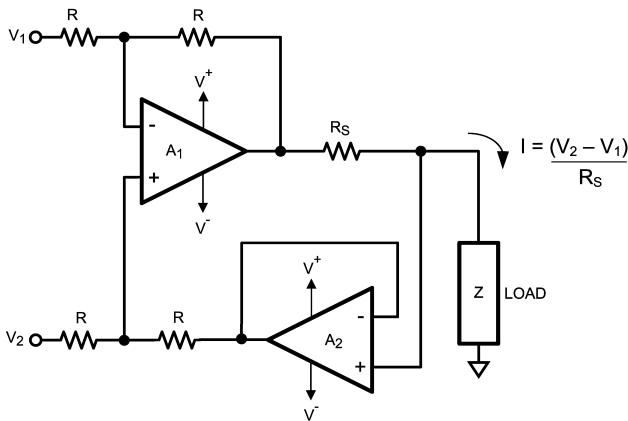

20127305

**FIGURE 6. Precision Current Source**

The equation for output current can be derived as follows:

$$\frac{V_2 R}{R + R} + \frac{(V_0 - I R_S) R}{R + R} = \frac{V_1 R}{R + R} + \frac{V_0 R}{R + R}$$

Solving for the current I results in the following equation:

$$I = \frac{V_2 - V_1}{R_S}$$

### LOW INPUT VOLTAGE NOISE

The LMP7701/LMP7702/LMP7704 have very low input voltage noise of  $9 \text{ nV} / \sqrt{\text{Hz}}$ . This input voltage noise can be further reduced by placing N amplifiers in parallel as shown in *Figure 7*. The total voltage noise on the output of this

circuit is divided by the square root of the number of amplifiers used in this parallel combination. This is because each individual amplifier acts as an independent noise source, and the average noise of independent sources is the quadrature sum of the independent sources divided by the number of sources. For N identical amplifiers, this means:

$$\begin{aligned} \text{REDUCED INPUT VOLTAGE NOISE} &= \frac{1}{N} \sqrt{e_{n1}^2 + e_{n2}^2 + \dots + e_{nN}^2} \\ &= \frac{1}{N} \sqrt{N e_n^2} = \frac{\sqrt{N}}{N} e_n \\ &= \frac{1}{\sqrt{N}} e_n \end{aligned}$$

*Figure 7* shows a schematic of this input voltage noise reduction circuit. Typical resistor values are:

$R_G = 10 \Omega$ ,  $R_F = 1 \text{ k}\Omega$ , and  $R_O = 1 \text{ k}\Omega$ .

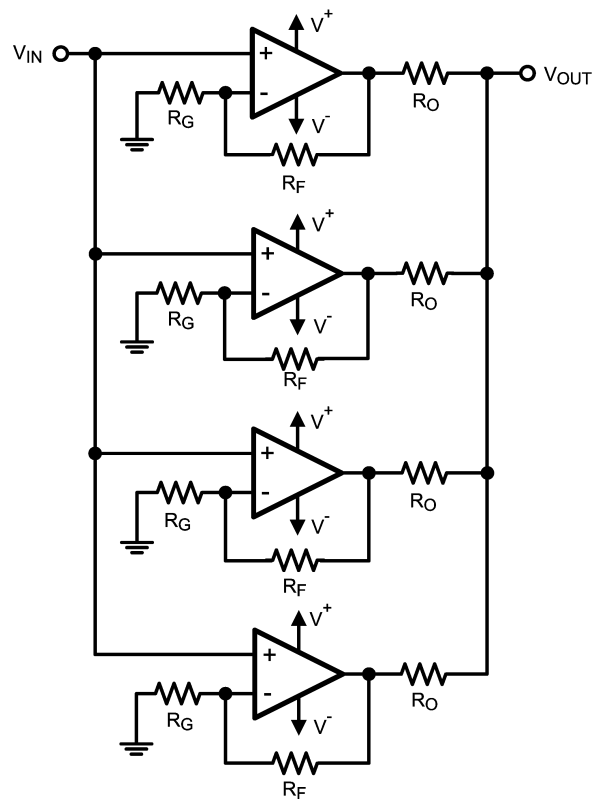

20127356

**FIGURE 7. Noise Reduction circuit**

## Application Information (Continued)

### TOTAL NOISE CONTRIBUTION

The LMP7701/LMP7702/LMP7704 have very low input bias current, very low input current noise, and very low input voltage noise. As a result, these amplifiers are ideal choices for circuits with high impedance sensor applications.

Figure 8 shows the typical input noise of the LMP7701/LMP7702/LMP7704 as a function of source resistance where:

$e_n$  denotes the input referred voltage noise

$e_i$  is the voltage drop across source resistance due to input referred current noise or  $e_i = R_S * i_n$

$e_t$  shows the thermal noise of the source resistance

$e_{ni}$  shows the total noise on the input.

Where:

$$e_{ni} = \sqrt{e_n^2 + e_i^2 + e_t^2}$$

The input current noise of the LMP7701/LMP7702/LMP7704 is so low that it will not become the dominant factor in the total noise unless source resistance exceeds 300 MΩ, which is an unrealistically high value.

As is evident in Figure 8, at lower  $R_S$  values, total noise is dominated by the amplifier's input voltage noise. Once  $R_S$  is larger than a few kilo-Ohms, then the dominant noise factor becomes the thermal noise of  $R_S$ . As mentioned before, the current noise will not be the dominant noise factor for any practical application.

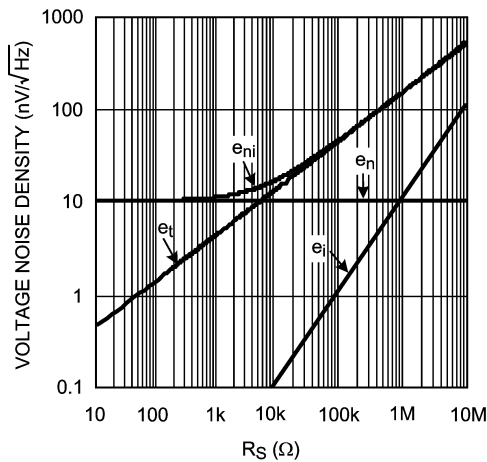
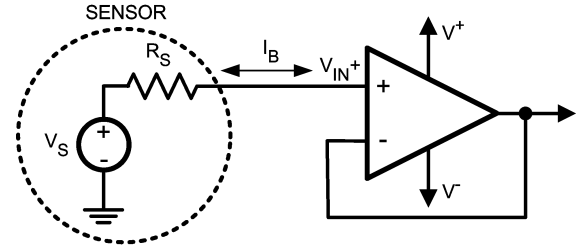

FIGURE 8. Total Input Noise

### HIGH IMPEDANCE SENSOR INTERFACE

Many sensors have high source impedances that may range up to 10 MΩ. The output signal of sensors often needs to be amplified or otherwise conditioned by means of an amplifier. The input bias current of this amplifier can load the sensor's output and cause a voltage drop across the source resistance as shown in Figure 9, where  $V_{IN+} = V_S - I_{BIAS} * R_S$

The last term,  $I_{BIAS} * R_S$ , shows the voltage drop across  $R_S$ . To prevent errors introduced to the system due to this voltage, an op amp with very low input bias current must be used with high impedance sensors. This is to keep the error contribution by  $I_{BIAS} * R_S$  less than the input voltage noise of the amplifier, so that it will not become the dominant noise factor.



20127359

FIGURE 9. Noise Due to  $I_{BIAS}$

pH electrodes are very high impedance sensors. As their name indicates, they are used to measure the pH of a solution. They usually do this by generating an output voltage which is proportional to the pH of the solution. pH electrodes are calibrated so that they have zero output for a neutral solution, pH = 7, and positive and negative voltages for acidic or alkaline solutions. This means that the output of a pH electrode is bipolar and has to be level shifted to be used in a single supply system. The rate of change of this voltage is usually shown in mV/pH and is different for different pH sensors. Temperature is also an important factor in a pH electrode reading. The output voltage of the sensor will change with temperature.

Figure 10 shows a typical output voltage spectrum of a pH electrode. Note that the exact values of output voltage will be different for different sensors. In this example, the pH electrode has an output voltage of 59.15 mV/pH at 25°C.

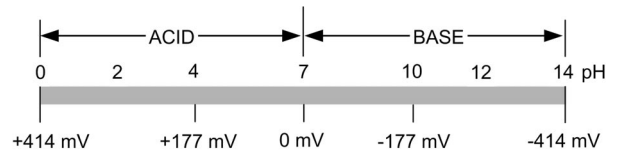

20127360

FIGURE 10. Output Voltage of a pH Electrode

The temperature dependence of a typical pH electrode is shown in Figure 11. As is evident, the output voltage changes with changes in temperature.

## Application Information (Continued)

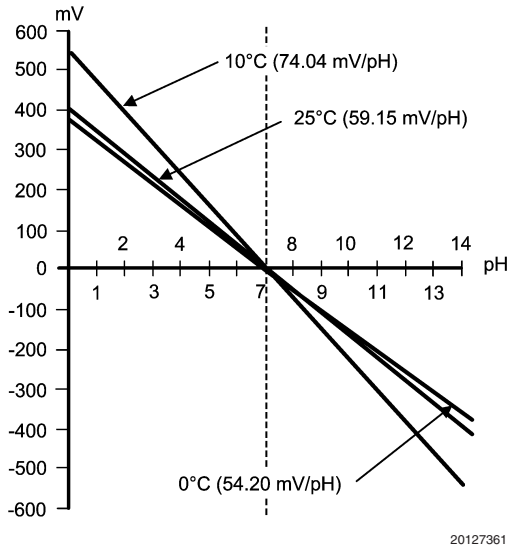

FIGURE 11. Temperature Dependence of a pH Electrode

The schematic shown in Figure 12 is a typical circuit which can be used for pH measurement. The LM35 is a precision integrated circuit temperature sensor. This sensor is differentiated from similar products because it has an output voltage linearly proportional to Celsius measurement, without the need to convert the temperature to Kelvin. The LM35

is used to measure the temperature of the solution and feeds this reading to the Analog to Digital Converter, ADC. This information is used by the ADC to calculate the temperature effects on the pH readings. The LM35 needs to have a resistor,  $R_T$  in Figure 12, to  $-V^+$  in order to be able to read temperatures below  $0^\circ\text{C}$ .  $R_T$  is not needed if temperatures are not expected to go below zero.

The output of pH electrodes are usually large enough that they don't require much amplification; however, due to the very high impedance, the output of a pH electrode needs to be buffered before it can go to an ADC. Since most ADCs are operated on single supply, the output of the pH electrode also needs to be level shifted. Amplifier A1 buffers the output of the pH electrode with a moderate gain of +2, while A2 provides the level shifting.  $V_{OUT}$  at the output of A2 is given by:  $V_{OUT} = -2V_{pH} + 1.024V$ .

LM4140A is a precision, low noise, voltage reference used to provide the level shift needed. The ADC used in this application is the ADC12032 which is a 12-bit, 2 channel converter with multiplexers on the inputs and a serial output. The 12-bit ADC enables users to measure pH with an accuracy of 0.003 of a pH unit. Adequate power supply bypassing and grounding is extremely important for ADCs. Recommended bypass capacitors are shown in Figure 12. It is common to share power supplies between different components in a circuit. To minimize the effects of power supply ripples caused by other components, the op amps need to have bypass capacitors on the supply pins. Using the same value capacitors as those used with the ADC are ideal. The combination of these three values of capacitors ensures that AC noise present on the power supply line is grounded and does not interfere with the amplifiers' signal.

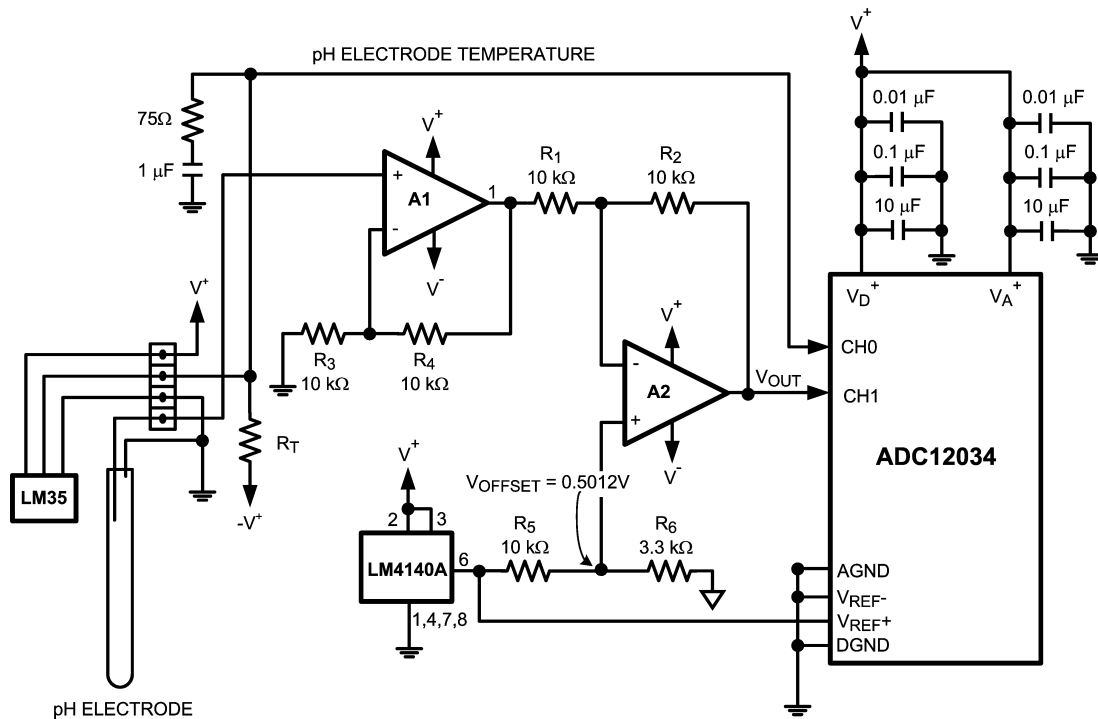
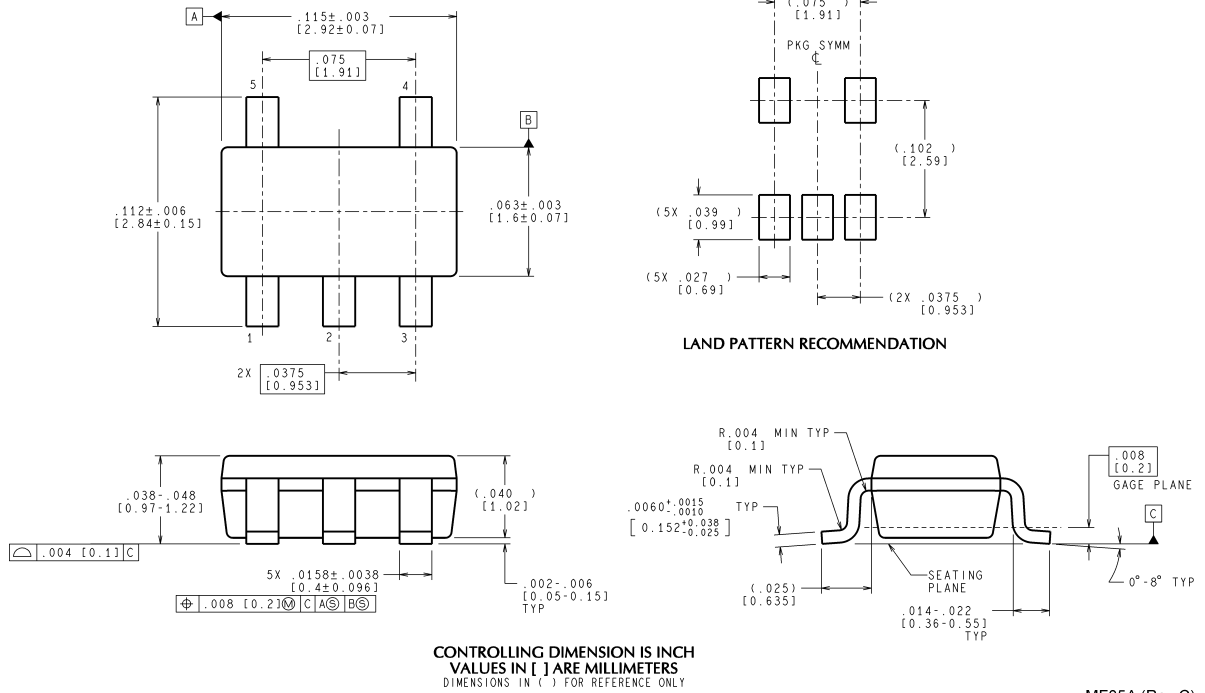
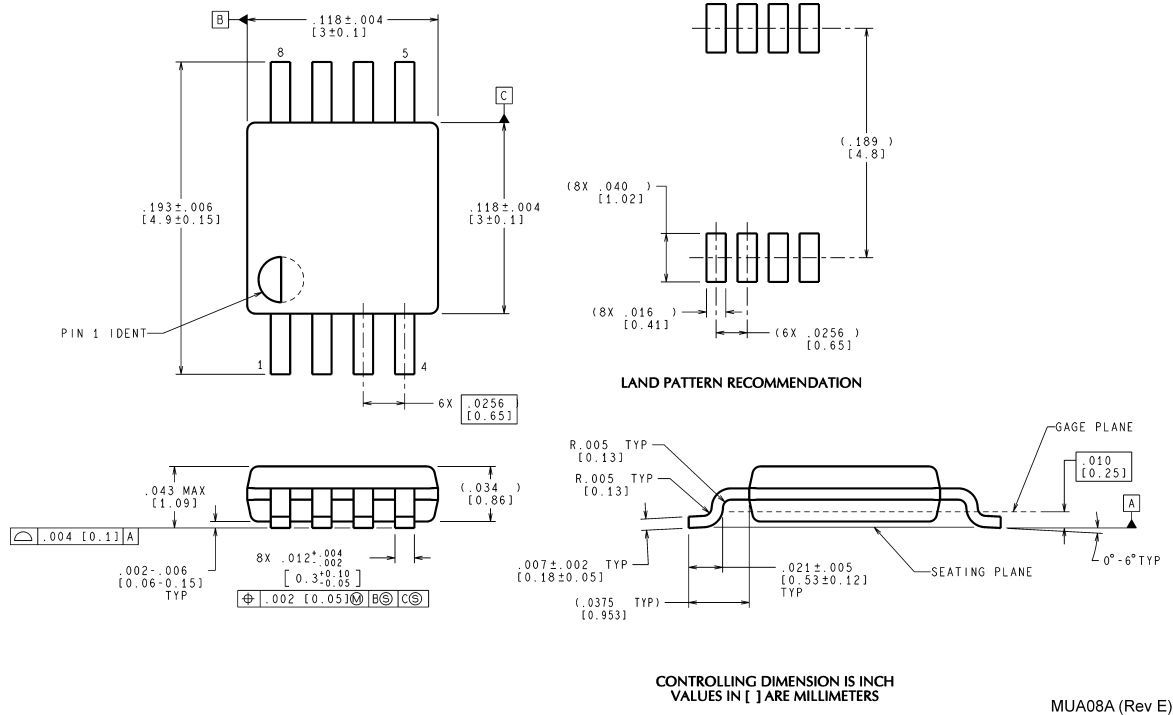

FIGURE 12. pH Measurement Circuit

**Physical Dimensions** inches (millimeters) unless otherwise noted



**5-Pin SOT23**  
**NS Package Number MF05A**



**8-Pin MSOP**  
**NS Package Number MUA08A**

**Physical Dimensions** inches (millimeters) unless otherwise noted (Continued)

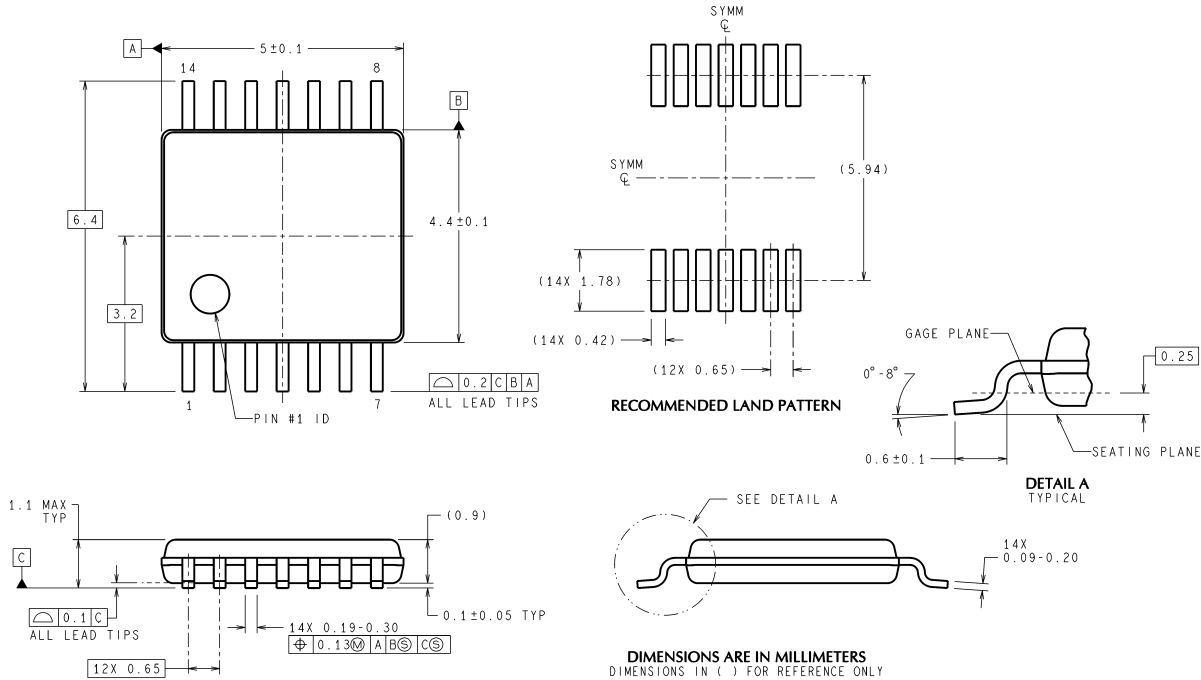

MTC14 (Rev D)

**14-Pin TSSOP  
NS Package Number MTC14**

National does not assume any responsibility for use of any circuitry described, no circuit patent licenses are implied and National reserves the right at any time without notice to change said circuitry and specifications.  
For the most current product information visit us at [www.national.com](http://www.national.com).

**LIFE SUPPORT POLICY**

NATIONAL'S PRODUCTS ARE NOT AUTHORIZED FOR USE AS CRITICAL COMPONENTS IN LIFE SUPPORT DEVICES OR SYSTEMS WITHOUT THE EXPRESS WRITTEN APPROVAL OF THE PRESIDENT AND GENERAL COUNSEL OF NATIONAL SEMICONDUCTOR CORPORATION. As used herein:

1. Life support devices or systems are devices or systems which, (a) are intended for surgical implant into the body, or (b) support or sustain life, and whose failure to perform when properly used in accordance with instructions for use provided in the labeling, can be reasonably expected to result in a significant injury to the user.
2. A critical component is any component of a life support device or system whose failure to perform can be reasonably expected to cause the failure of the life support device or system, or to affect its safety or effectiveness.

**BANNED SUBSTANCE COMPLIANCE**

National Semiconductor manufactures products and uses packing materials that meet the provisions of the Customer Products Stewardship Specification (CSP-9-111C2) and the Banned Substances and Materials of Interest Specification (CSP-9-111S2) and contain no "Banned Substances" as defined in CSP-9-111S2.

Leadfree products are RoHS compliant.



**National Semiconductor**  
Americas Customer  
Support Center  
Email: [new.feedback@nsc.com](mailto:new.feedback@nsc.com)  
Tel: 1-800-272-9959

**National Semiconductor**  
Europe Customer Support Center  
Fax: +49 (0) 180-530 85 86  
Email: [europe.support@nsc.com](mailto:europe.support@nsc.com)  
Deutsch Tel: +49 (0) 69 9508 6208  
English Tel: +44 (0) 870 24 0 2171  
Français Tel: +33 (0) 1 41 91 8790

**National Semiconductor**  
Asia Pacific Customer  
Support Center  
Email: [ap.support@nsc.com](mailto:ap.support@nsc.com)

**National Semiconductor**  
Japan Customer Support Center  
Fax: 81-3-5639-7507  
Email: [jpn.feedback@nsc.com](mailto:jpn.feedback@nsc.com)  
Tel: 81-3-5639-7560