

LMP7715/LMP7716

Single and Dual Precision, 17 MHz, Low Noise, CMOS Input Amplifiers

General Description

The LMP7715/LMP7716 are single and dual low noise, low offset, CMOS input, rail-to-rail output precision amplifiers with high gain bandwidth products. The LMP7715/LMP7716 are part of the LMP™ precision amplifier family and are ideal for a variety of instrumentation applications.

Utilizing a CMOS input stage, the LMP7715/LMP7716 achieve an input bias current of 100 fA, an input referred voltage noise of $5.8 \text{ nV}/\sqrt{\text{Hz}}$, and an input offset voltage of less than $\pm 150 \mu\text{V}$. These features make the LMP7715/LMP7716 superior choices for precision applications.

Consuming only 1.15 mA of supply current, the LMP7715 offers a high gain bandwidth product of 17 MHz, enabling accurate amplification at high closed loop gains.

The LMP7715/LMP7716 have a supply voltage range of 1.8V to 5.5V, which makes these ideal choices for portable low power applications with low supply voltage requirements.

The LMP7715/LMP7716 are built with National's advanced VIP50 process technology. The LMP7715 is offered in a 5-pin SOT23 package and the LMP7716 is offered in an 8-pin MSOP.

Features

Unless otherwise noted, typical values at $V_S = 5\text{V}$.

- Input offset voltage $\pm 150 \mu\text{V}$ (max)
- Input bias current 100 fA
- Input voltage noise $5.8 \text{ nV}/\sqrt{\text{Hz}}$
- Gain bandwidth product 17 MHz
- Supply current (LMP7715) 1.15 mA
- Supply current (LMP7716) 1.30 mA
- Supply voltage range 1.8V to 5.5V
- THD+N @ $f = 1 \text{ kHz}$ 0.001%
- Operating temperature range -40°C to 125°C
- Rail-to-rail output swing
- Space saving SOT23 package (LMP7715)
- MSOP-8 package (LMP7716)

Applications

- Active filters and buffers
- Sensor interface applications
- Transimpedance amplifiers

Typical Performance

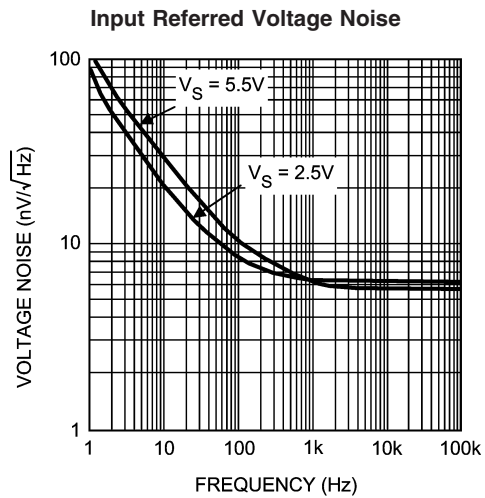
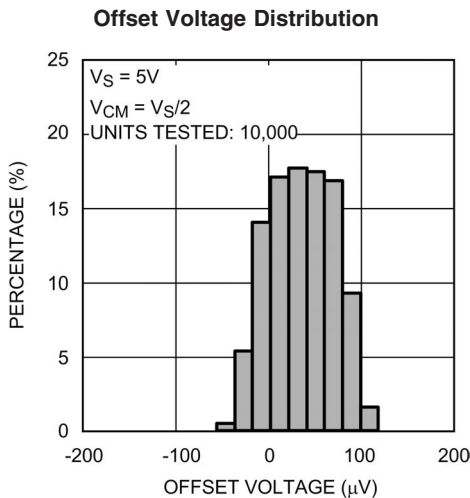

LMP™ is a trademark of National Semiconductor Corporation.

Absolute Maximum Ratings (Note 1)

If Military/Aerospace specified devices are required, please contact the National Semiconductor Sales Office/Distributors for availability and specifications.

ESD Tolerance (Note 2)	
Human Body Model	2000V
Machine Model	200V
V_{IN} Differential	$\pm 0.3V$
Supply Voltage ($V_S = V^+ - V^-$)	6.0V
Voltage on Input/Output Pins	$V^+ +0.3V, V^- -0.3V$
Storage Temperature Range	$-65^\circ C$ to $150^\circ C$
Junction Temperature (Note 3)	$+150^\circ C$

Soldering Information

Infrared or Convection (20 sec)	$235^\circ C$
Wave Soldering Lead Temp. (10 sec)	$260^\circ C$

Operating Ratings (Note 1)

Temperature Range (Note 3)	$-40^\circ C$ to $125^\circ C$
Supply Voltage ($V_S = V^+ - V^-$)	1.8V to 5.5V
$0^\circ C \leq T_A \leq 125^\circ C$	1.8V to 5.5V
$-40^\circ C \leq T_A \leq 125^\circ C$	2.0V to 5.5V
Package Thermal Resistance (θ_{JA} (Note 3))	
5-Pin SOT23	$180^\circ C/W$
8-Pin MSOP	$236^\circ C/W$

2.5V Electrical Characteristics

Unless otherwise specified, all limits are guaranteed for $T_A = 25^\circ C$, $V^+ = 2.5V$, $V^- = 0V$, $V_O = V_{CM} = V^+/2$. **Boldface** limits apply at the temperature extremes.

Symbol	Parameter	Conditions	Min (Note 5)	Typ (Note 4)	Max (Note 5)	Units
V_{OS}	Input Offset Voltage			± 20	± 180 ± 480	μV
TC V_{OS}	Input Offset Voltage Drift (Note 6)	LMP7715		-1	± 4	$\mu V/^\circ C$
		LMP7716		-1.75		
I_B	Input Bias Current	$V_{CM} = 1V$ (Notes 7, 8)		0.05	50 100	pA
I_{OS}	Input Offset Current	$V_{CM} = 1V$ (Note 8)		0.006	25 50	pA
CMRR	Common Mode Rejection Ratio	$0V \leq V_{CM} \leq 1.4V$	83 80	100		dB
PSRR	Power Supply Rejection Ratio	$2.0V \leq V^+ \leq 5.5V$ $V^- = 0V, V_{CM} = 0$	85 80	100		dB
		$1.8V \leq V^+ \leq 5.5V$ $V^- = 0V, V_{CM} = 0$	85	98		
CMVR	Input Common-Mode Voltage Range	CMRR ≥ 80 dB CMRR ≥ 78 dB	-0.3 -0.3		1.5 1.5	V
A_{VOL}	Large Signal Voltage Gain	LMP7715, $V_O = 0.15$ to $2.2V$ $R_L = 2$ k Ω to $V^+/2$	88 82	98		dB
		LMP7716, $V_O = 0.15$ to $2.2V$ $R_L = 2$ k Ω to $V^+/2$	84 80	92		
		LMP7715, $V_O = 0.15$ to $2.2V$ $R_L = 10$ k Ω to $V^+/2$	92 88	110		
		LMP7716, $V_O = 0.15$ to $2.2V$ $R_L = 10$ k Ω to $V^+/2$	90 86	95		
V_O	Output Swing High	$R_L = 2$ k Ω to $V^+/2$	70 77	25		mV from V^+
		$R_L = 10$ k Ω to $V^+/2$	60 66	20		
	Output Swing Low	$R_L = 2$ k Ω to $V^+/2$		30	70 73	mV
		$R_L = 10$ k Ω to $V^+/2$		15	60 62	

2.5V Electrical Characteristics (Continued)

Unless otherwise specified, all limits are guaranteed for $T_A = 25^\circ\text{C}$, $V^+ = 2.5\text{V}$, $V^- = 0\text{V}$, $V_O = V_{CM} = V^+/2$. **Boldface** limits apply at the temperature extremes.

Symbol	Parameter	Conditions	Min (Note 5)	Typ (Note 4)	Max (Note 5)	Units
I_O	Output Short Circuit Current	Sourcing to V^- $V_{IN} = 200\text{ mV}$ (Note 9)	36 30	52		mA
		Sinking to V^+ $V_{IN} = -200\text{ mV}$ (Note 9)	7.5 5.0	15		
I_S	Supply Current	LMP7715		0.95	1.30 1.65	mA
		LMP7716 (per channel)		1.10	1.50 1.85	
SR	Slew Rate	$A_V = +1$, Rising (10% to 90%)		8.3		V/ μs
		$A_V = +1$, Falling (90% to 10%)		10.3		
GBW	Gain Bandwidth Product			14		MHz
e_n	Input-Referred Voltage Noise	$f = 400\text{ Hz}$		6.8		nV/ $\sqrt{\text{Hz}}$
		$f = 1\text{ kHz}$		5.8		
i_n	Input-Referred Current Noise	$f = 1\text{ kHz}$		0.01		pA/ $\sqrt{\text{Hz}}$
THD+N	Total Harmonic Distortion + Noise	$f = 1\text{ kHz}$, $A_V = 1$, $R_L = 100\text{ k}\Omega$ $V_O = 0.9 V_{PP}$		0.003		%
		$f = 1\text{ kHz}$, $A_V = 1$, $R_L = 600\Omega$ $V_O = 0.9 V_{PP}$		0.004		

5V Electrical Characteristics

Unless otherwise specified, all limits are guaranteed for $T_A = 25^\circ\text{C}$, $V^+ = 5\text{V}$, $V^- = 0\text{V}$, $V_{CM} = V^+/2$. **Boldface** limits apply at the temperature extremes.

Symbol	Parameter	Conditions	Min (Note 5)	Typ (Note 4)	Max (Note 5)	Units
V_{OS}	Input Offset Voltage			± 10	± 150 ± 450	μV
TC V_{OS}	Input Offset Average Drift (Note 6)	LMP7715		-1	± 4	$\mu\text{V}/^\circ\text{C}$
		LMP7716		-1.75		
I_B	Input Bias Current	(Notes 7, 8)		0.1	50 100	pA
I_{OS}	Input Offset Current	(Note 8)		0.01	25 50	pA
CMRR	Common Mode Rejection Ratio	$0\text{V} \leq V_{CM} \leq 3.7\text{V}$	85 82	100		dB
PSRR	Power Supply Rejection Ratio	$2.0\text{V} \leq V^+ \leq 5.5\text{V}$ $V^- = 0\text{V}$, $V_{CM} = 0$	85 80	100		dB
		$1.8\text{V} \leq V^+ \leq 5.5\text{V}$ $V^- = 0\text{V}$, $V_{CM} = 0$	85	98		
CMVR	Input Common-Mode Voltage Range	CMRR $\geq 80\text{ dB}$ CMRR $\geq 78\text{ dB}$	-0.3 -0.3		4 4	V
A_{VOL}	Large Signal Voltage Gain	LMP7715, $V_O = 0.3\text{ to }4.7\text{V}$ $R_L = 2\text{ k}\Omega$ to $V^+/2$	88 82	107		dB
		LMP7716, $V_O = 0.3\text{ to }4.7\text{V}$ $R_L = 2\text{ k}\Omega$ to $V^+/2$	84 80	90		
		LMP7715, $V_O = 0.3\text{ to }4.7\text{V}$ $R_L = 10\text{ k}\Omega$ to $V^+/2$	92 88	110		
		LMP7716, $V_O = 0.3\text{ to }4.7\text{V}$ $R_L = 10\text{ k}\Omega$ to $V^+/2$	90 86	95		

5V Electrical Characteristics (Continued)

V _O	Output Swing High	R _L = 2 kΩ to V ⁺ /2	70 77	32		mV from V ⁺	
		R _L = 10 kΩ to V ⁺ /2	60 66	22			
	Output Swing Low	R _L = 2 kΩ to V ⁺ /2 (LMP7715)			42	70 73	mV
		R _L = 2 kΩ to V ⁺ /2 (LMP7716)			50	75 78	
		R _L = 10 kΩ to V ⁺ /2			20	60 62	
I _O	Output Short Circuit Current	Sourcing to V ⁻ V _{IN} = 200 mV (Note 9)	46 38	66		mA	
		Sinking to V ⁺ V _{IN} = -200 mV (Note 9)	10.5 6.5	23			
I _S	Supply Current	LMP7715		1.15	1.40 1.75	mA	
		LMP7716 (per channel)		1.30	1.70 2.05		
SR	Slew Rate	A _V = +1, Rising (10% to 90%)	6.0	9.5		V/μs	
		A _V = +1, Falling (90% to 10%)	7.5	11.5			
GBW	Gain Bandwidth Product			17		MHz	
e _n	Input-Referred Voltage Noise	f = 400 Hz		7.0		nV/√Hz	
		f = 1 kHz		5.8			
i _n	Input-Referred Current Noise	f = 1 kHz		0.01		pA/√Hz	
THD+N	Total Harmonic Distortion + Noise	f = 1 kHz, A _V = 1, R _L = 100 kΩ V _O = 4 V _{PP}		0.001		%	
		f = 1 kHz, A _V = 1, R _L = 600Ω V _O = 4 V _{PP}		0.004			

Note 1: Absolute Maximum Ratings indicate limits beyond which damage to the device may occur. Operating Ratings indicate conditions for which the device is intended to be functional, but specific performance is not guaranteed. For guaranteed specifications and the test conditions, see the Electrical Characteristics Tables.

Note 2: Human Body Model is 1.5 kΩ in series with 100 pF. Machine Model is 0Ω in series with 200 pF.

Note 3: The maximum power dissipation is a function of $T_{J(MAX)}$, θ_{JA} . The maximum allowable power dissipation at any ambient temperature is $P_D = (T_{J(MAX)} - T_A)/\theta_{JA}$. All numbers apply for packages soldered directly onto a PC Board.

Note 4: Typical values represent the most likely parametric norm at the time of characterization.

Note 5: Limits are 100% production tested at 25°C. Limits over the operating temperature range are guaranteed through correlations using the Statistical Quality Control (SQC) method.

Note 6: Offset voltage average drift is determined by dividing the change in V_{OS} at the temperature extremes by the total temperature change.

Note 7: Positive current corresponds to current flowing into the device.

Note 8: Guaranteed by design.

Note 9: The short circuit test is a momentary open loop test.

Connection Diagrams

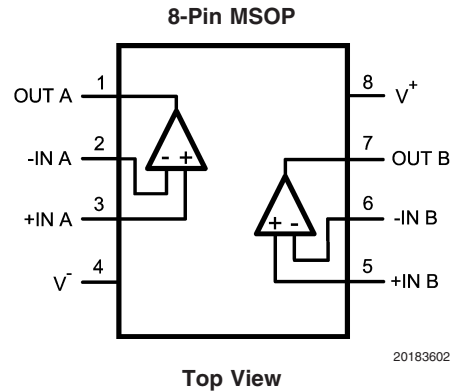
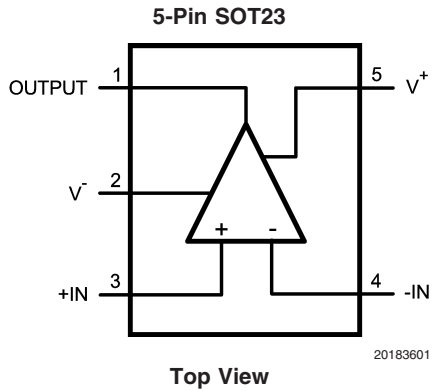

Ordering Information

Package	Part Number	Package Marking	Transport Media	NSC Drawing
5-Pin SOT23	LMP7715MF	AV3A	1k Units Tape and Reel	MF05A
	LMP7715MFX		3k Units Tape and Reel	
8-Pin MSOP	LMP7716MM	AX3A	1k Units Tape and Reel	MUA08A
	LMP7716MMX		3.5k Units Tape and Reel	

Typical Performance Characteristics Unless otherwise noted: $T_A = 25^\circ\text{C}$, $V_S = 5\text{V}$, $V_{CM} = V_S/2$.

Offset Voltage Distribution

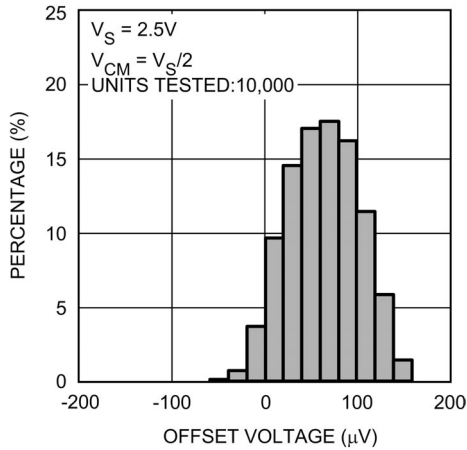

20183681

TCV_{OS} Distribution (LMP7715)

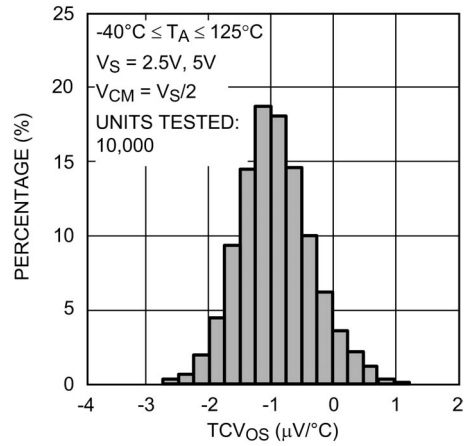

20183603

Offset Voltage Distribution

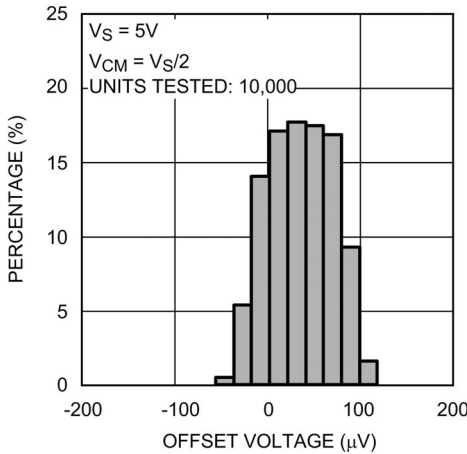

20183622

TCV_{OS} Distribution (LMP7716)

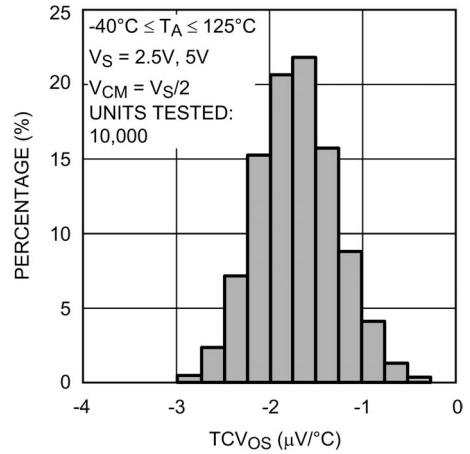

20183680

Offset Voltage vs. V_{CM}

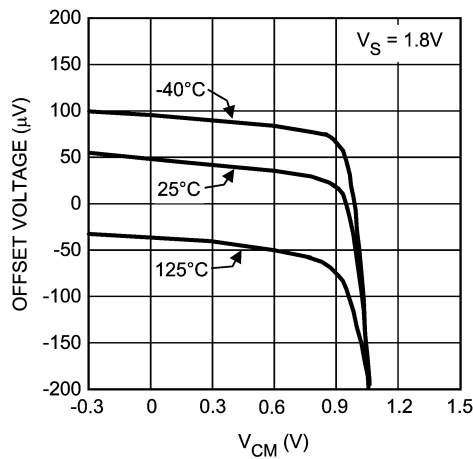

20183610

Offset Voltage vs. V_{CM}

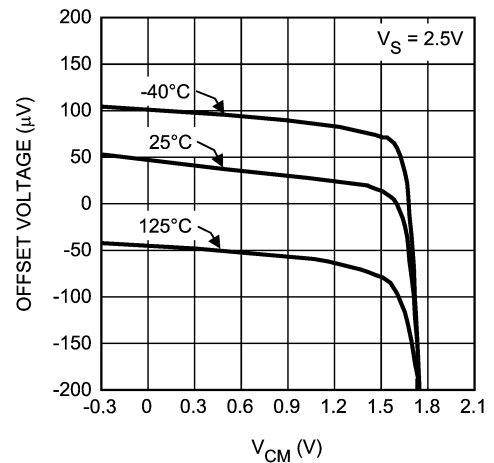

20183611

Typical Performance Characteristics Unless otherwise noted: $T_A = 25^\circ\text{C}$, $V_S = 5\text{V}$, $V_{CM} = V_S/2$. (Continued)

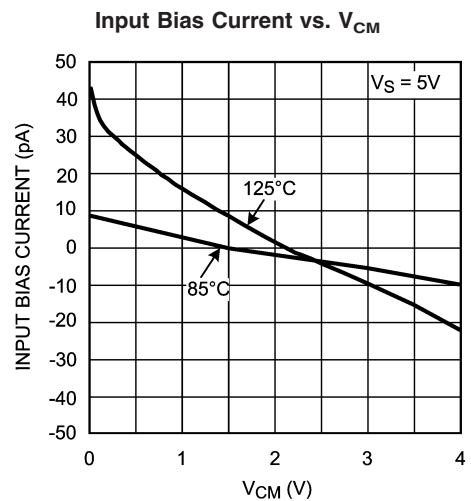
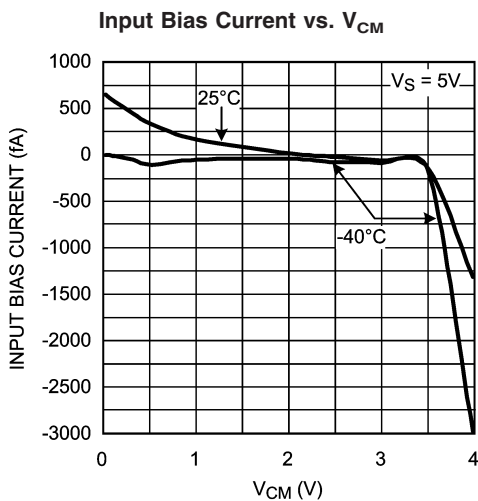
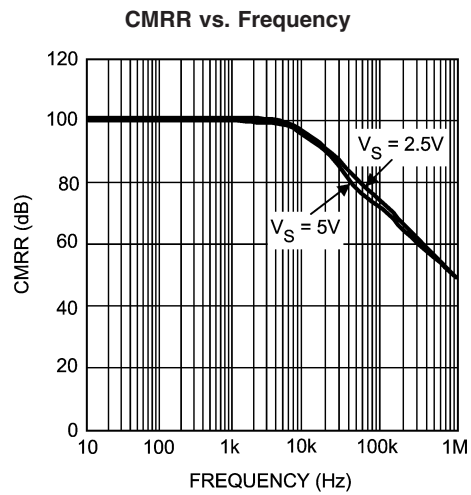
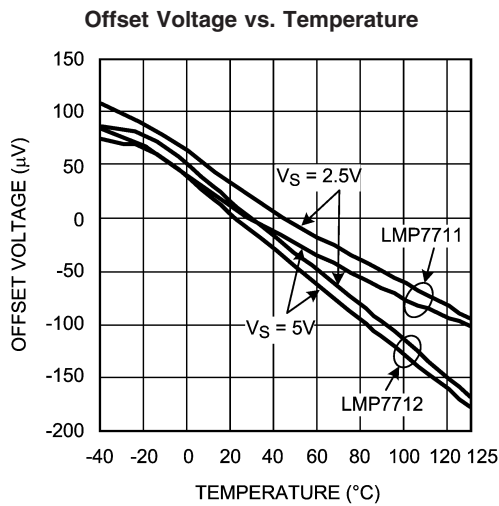
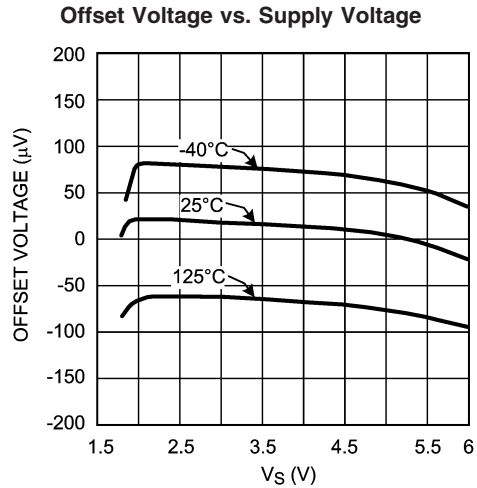
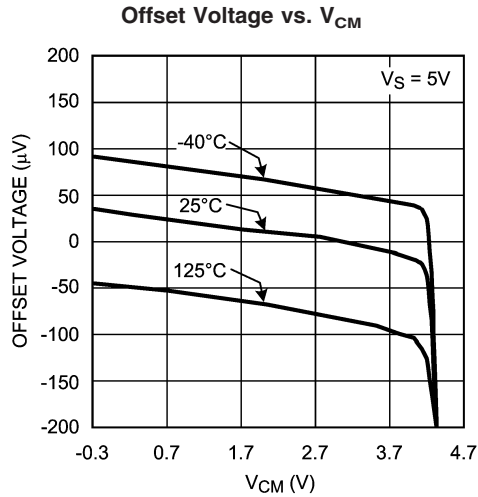

Typical Performance Characteristics Unless otherwise noted: $T_A = 25^\circ\text{C}$, $V_S = 5\text{V}$, $V_{CM} = V_S/2$. (Continued)

Supply Current vs. Supply Voltage (LMP7715)

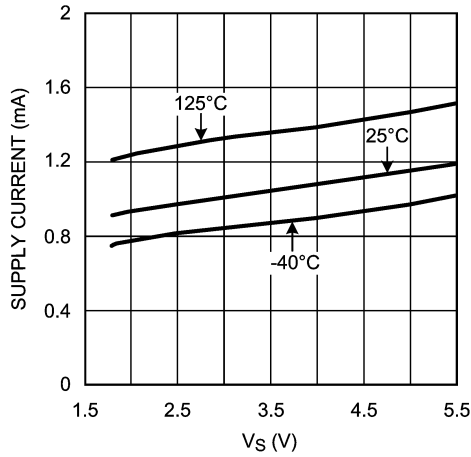

20183605

Supply Current vs. Supply Voltage (LMP7716)

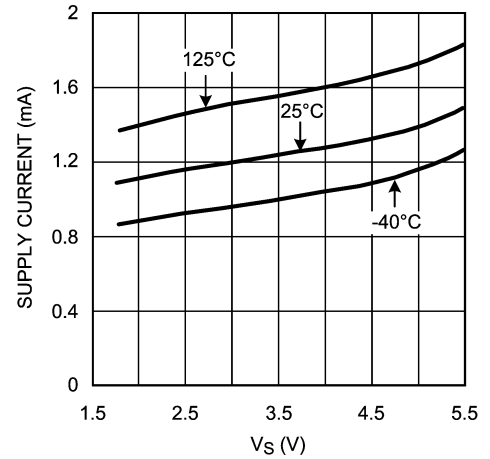

20183677

Crosstalk Rejection Ratio (LMP7716)

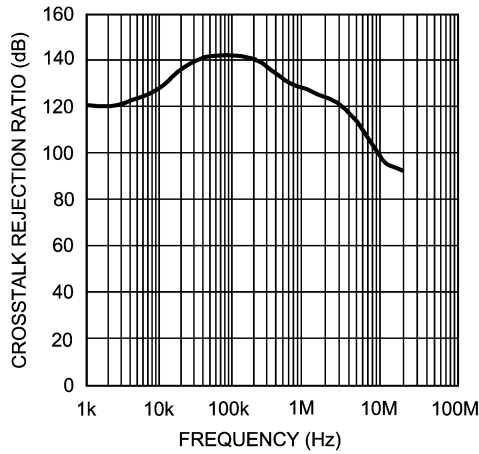

20183676

Sourcing Current vs. Supply Voltage

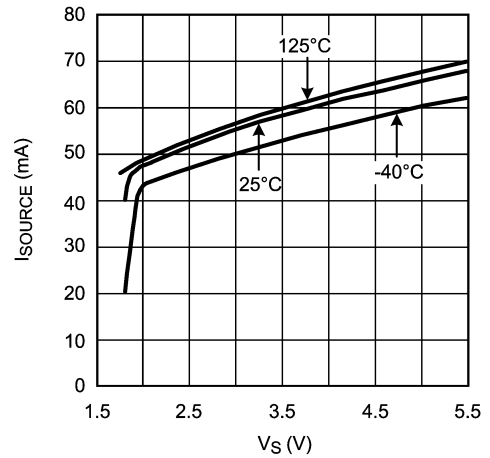

20183620

Sinking Current vs. Supply Voltage

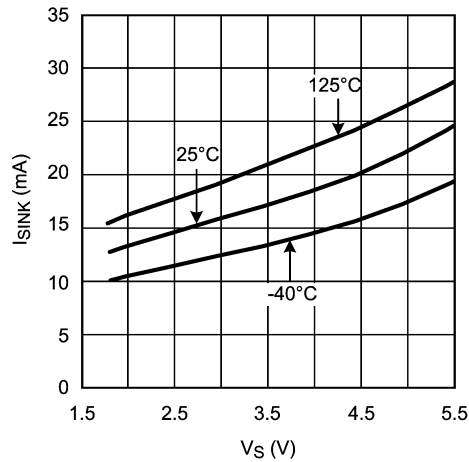

20183619

Sourcing Current vs. Output Voltage

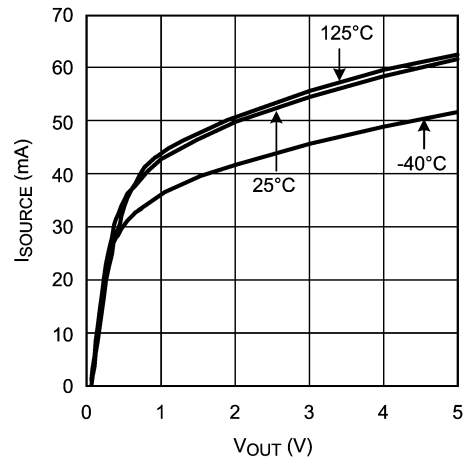

20183650

Typical Performance Characteristics Unless otherwise noted: $T_A = 25^\circ\text{C}$, $V_S = 5\text{V}$, $V_{CM} = V_S/2$. (Continued)

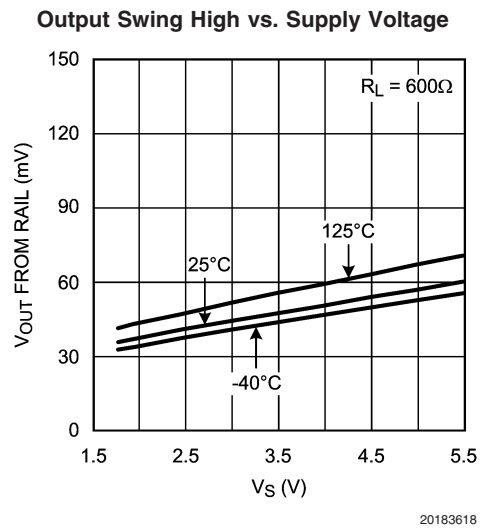
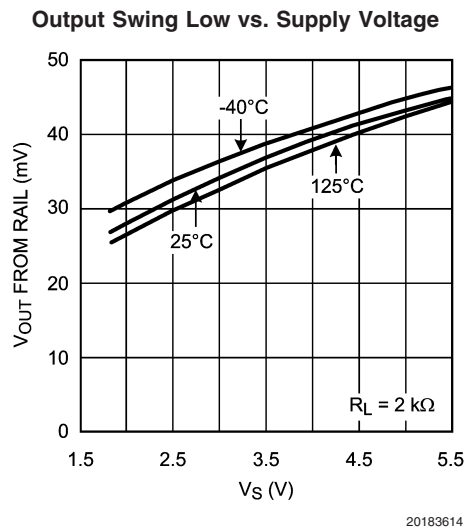
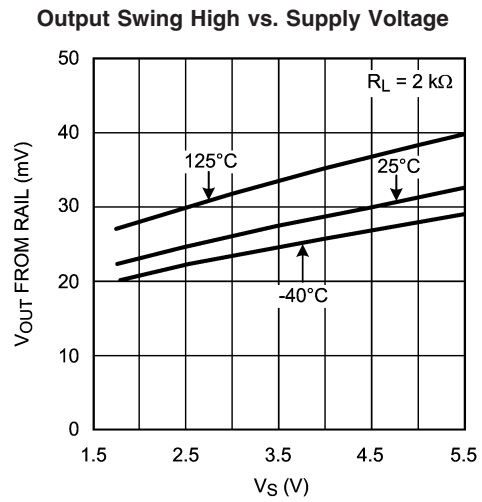
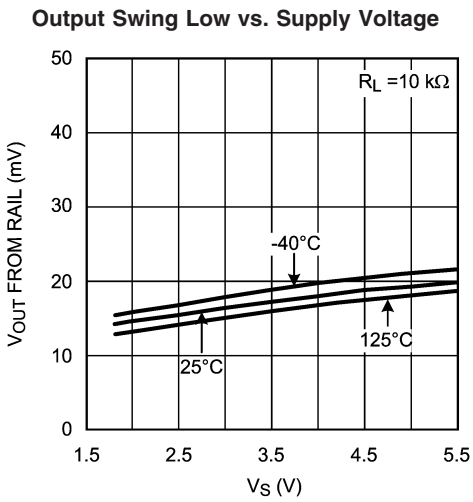
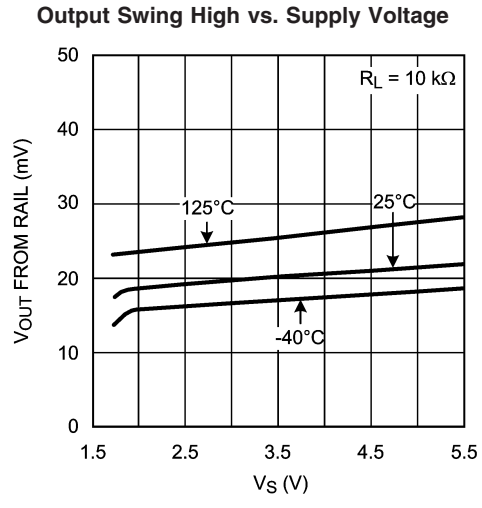
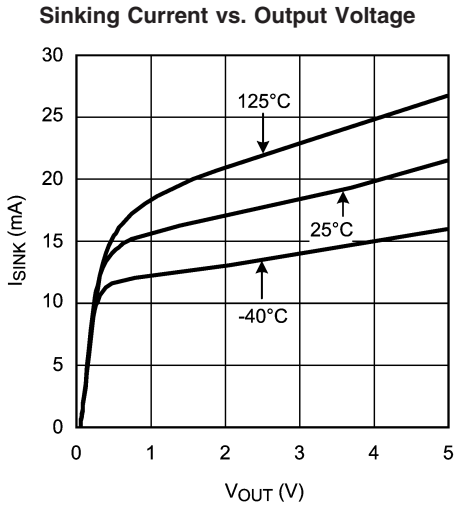

Typical Performance Characteristics Unless otherwise noted: $T_A = 25^\circ\text{C}$, $V_S = 5\text{V}$, $V_{\text{CM}} = V_S/2$. (Continued)

Output Swing Low vs. Supply Voltage

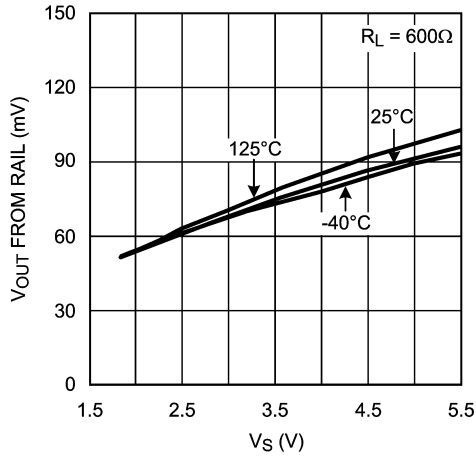

20183613

Open Loop Frequency Response

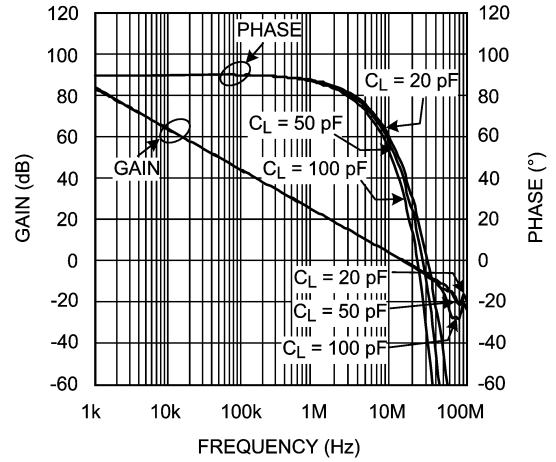

20183641

Open Loop Frequency Response

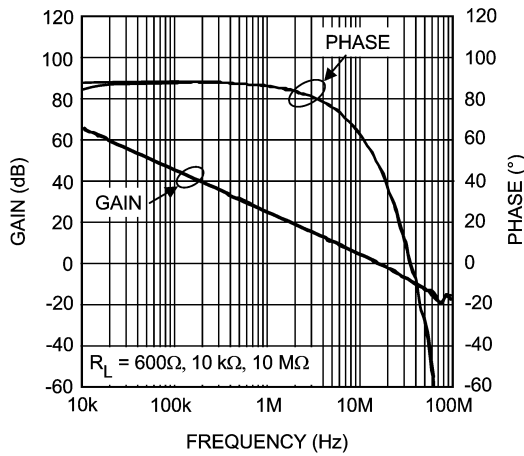

20183673

Phase Margin vs. Capacitive Load

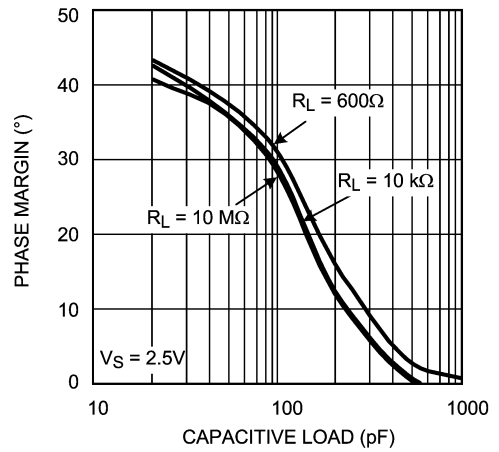

20183645

Phase Margin vs. Capacitive Load

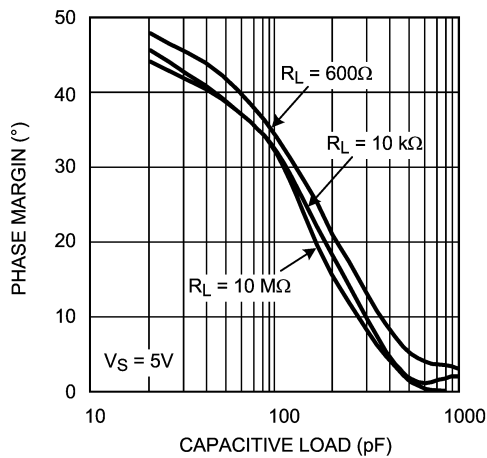

20183646

Overshoot and Undershoot vs. Capacitive Load

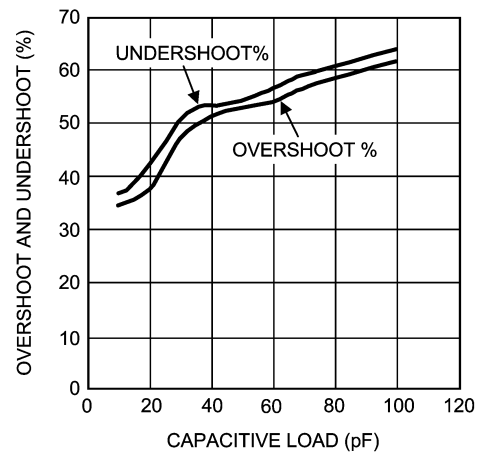

20183630

Typical Performance Characteristics Unless otherwise noted: $T_A = 25^\circ\text{C}$, $V_S = 5\text{V}$, $V_{CM} = V_S/2$. (Continued)

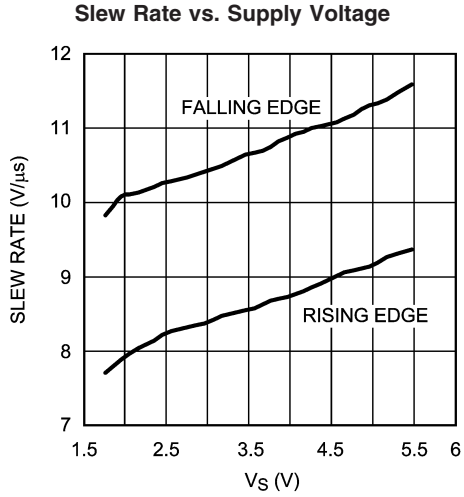

20183629

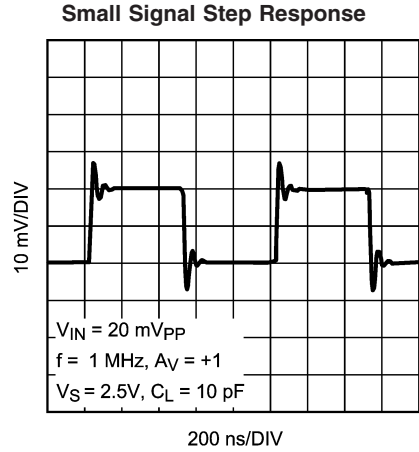

20183638

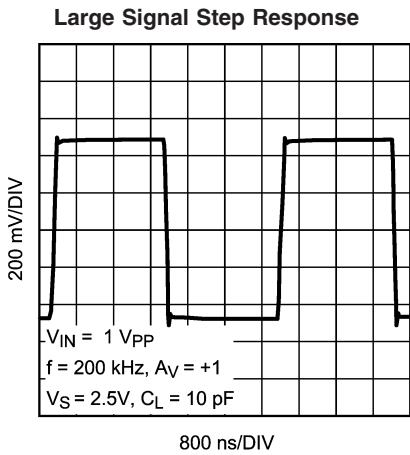

20183637

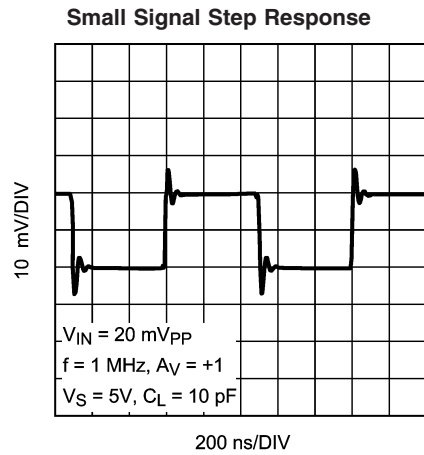

20183633

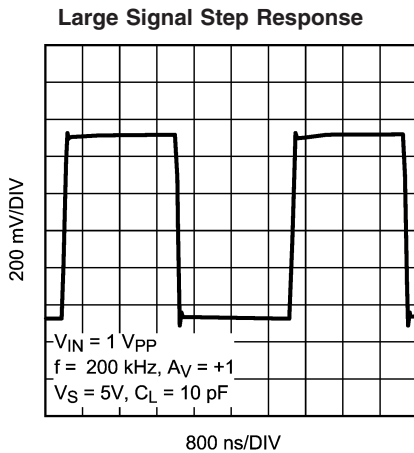

20183634

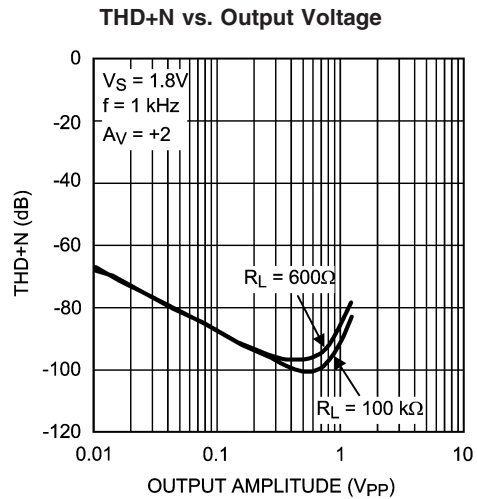

20183626

Typical Performance Characteristics Unless otherwise noted: $T_A = 25^\circ\text{C}$, $V_S = 5\text{V}$, $V_{\text{CM}} = V_S/2$. (Continued)

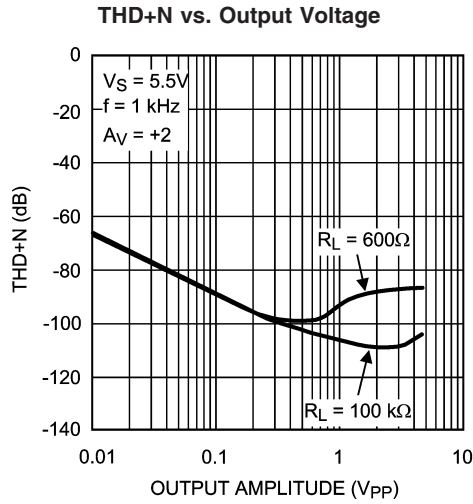

20183604

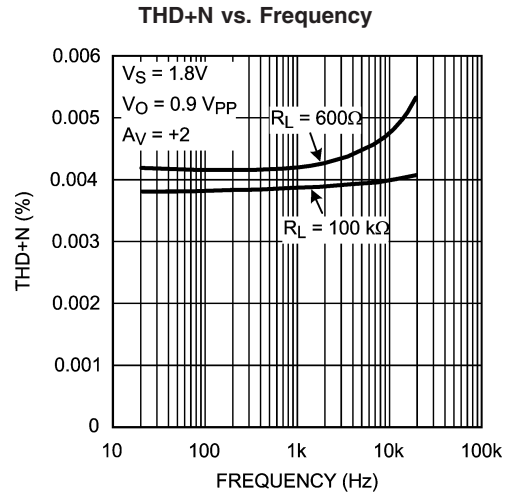

20183657

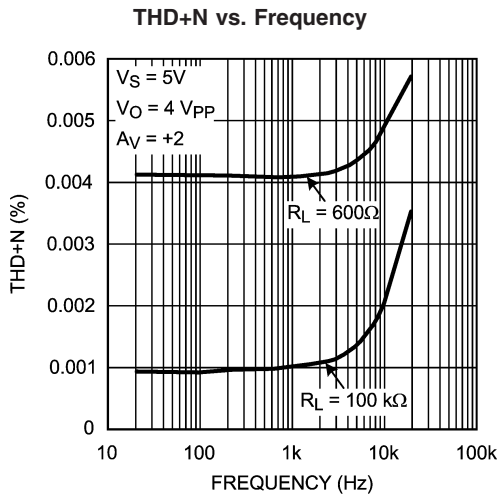

20183655

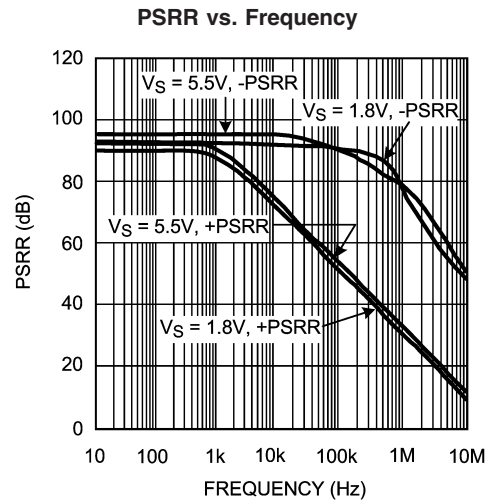

20183628

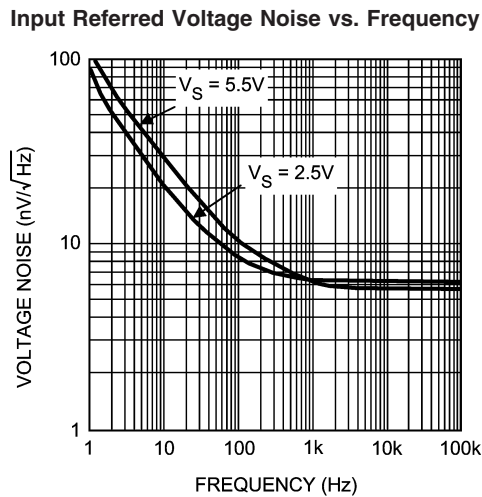

20183639

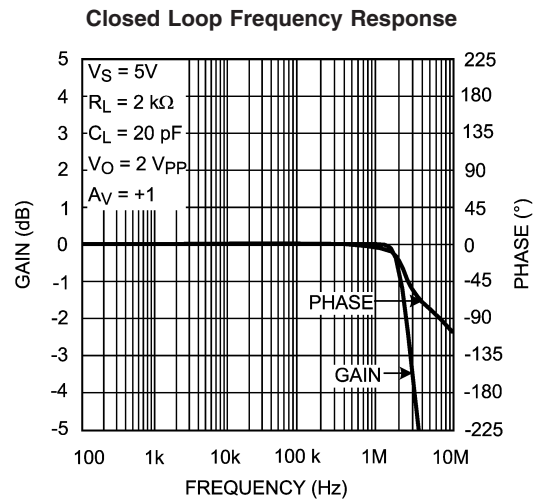

20183636

Typical Performance Characteristics

Unless otherwise noted: $T_A = 25^\circ\text{C}$, $V_S = 5\text{V}$, $V_{CM} =$

$V_S/2$. (Continued)

Closed Loop Output Impedance vs. Frequency

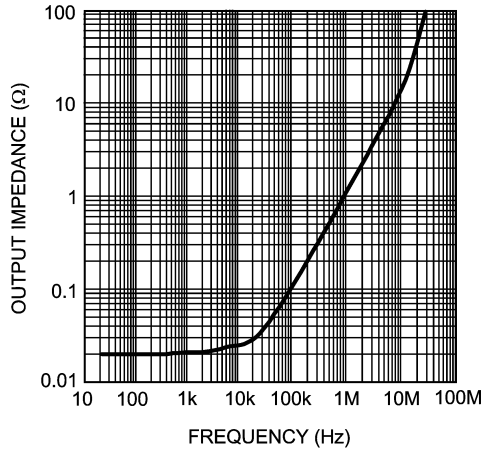

20183632

Application Information

LMP7715/LMP7716

The LMP7715/LMP7716 are single and dual, low noise, low offset, rail-to-rail output precision amplifiers with a wide gain bandwidth product of 17 MHz and low supply current. The wide bandwidth makes the LMP7715/LMP7716 ideal choices for wide-band amplification in portable applications.

The LMP7715/LMP7716 are superior for sensor applications. The very low input referred voltage noise of only 5.8 nV/√Hz at 1 kHz and very low input referred current noise of only 10 fA/√Hz mean more signal fidelity and higher signal-to-noise ratio.

The LMP7715/LMP7716 have a supply voltage range of 1.8V to 5.5V over a wide temperature range of 0°C to 125°C. This is optimal for low voltage commercial applications. For applications where the ambient temperature might be less than 0°C, the LMP7715/LMP7716 are fully operational at supply voltages of 2.0V to 5.5V over the temperature range of -40°C to 125°C.

The outputs of the LMP7715/LMP7716 swing within 25 mV of either rail providing maximum dynamic range in applications requiring low supply voltage. The input common mode range of the LMP7715/LMP7716 extends to 300 mV below ground. This feature enables users to utilize this device in single supply applications.

The use of a very innovative feedback topology has enhanced the current drive capability of the LMP7715/LMP7716, resulting in sourcing currents of as much as 47 mA with a supply voltage of only 1.8V.

The LMP7715 is offered in the space saving SOT23 package and the LMP7716 is offered in an 8-pin MSOP. These small packages are ideal solutions for applications requiring minimum PC board footprint.

CAPACITIVE LOAD

The unity gain follower is the most sensitive configuration to capacitive loading. The combination of a capacitive load placed directly on the output of an amplifier along with the output impedance of the amplifier creates a phase lag which in turn reduces the phase margin of the amplifier. If phase margin is significantly reduced, the response will be either underdamped or the amplifier will oscillate.

The LMP7715/LMP7716 can directly drive capacitive loads of up to 120 pF without oscillating. To drive heavier capacitive loads, an isolation resistor, R_{ISO} as shown in *Figure 1*, should be used. This resistor and C_L form a pole and hence delay the phase lag or increase the phase margin of the overall system. The larger the value of R_{ISO} , the more stable the output voltage will be. However, larger values of R_{ISO} result in reduced output swing and reduced output current drive.

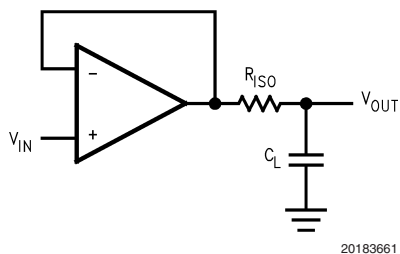

20183661

FIGURE 1. Isolating Capacitive Load

INPUT CAPACITANCE

CMOS input stages inherently have low input bias current and higher input referred voltage noise. The LMP7715/LMP7716 enhance this performance by having the low input bias current of only 50 fA, as well as, a very low input referred voltage noise of 5.8 nV/√Hz. In order to achieve this a larger input stage has been used. This larger input stage increases the input capacitance of the LMP7715/LMP7716. *Figure 2* shows typical input common mode capacitance of the LMP7715/LMP7716.

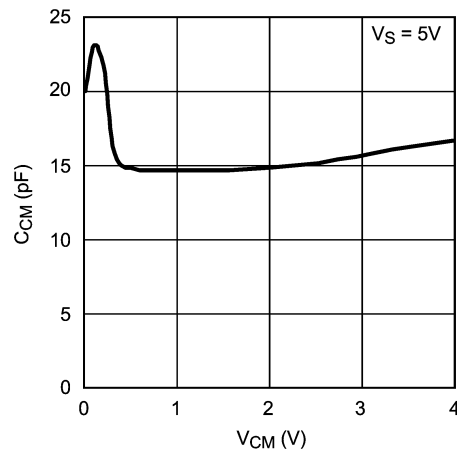

20183675

FIGURE 2. Input Common Mode Capacitance

This input capacitance will interact with other impedances, such as gain and feedback resistors which are seen on the inputs of the amplifier, to form a pole. This pole will have little or no effect on the output of the amplifier at low frequencies and under DC conditions, but will play a bigger role as the frequency increases. At higher frequencies, the presence of this pole will decrease phase margin and also cause gain peaking. In order to compensate for the input capacitance, care must be taken in choosing feedback resistors. In addition to being selective in picking values for the feedback resistor, a capacitor can be added to the feedback path to increase stability.

The DC gain of the circuit shown in *Figure 3* is simply $-R_2/R_1$.

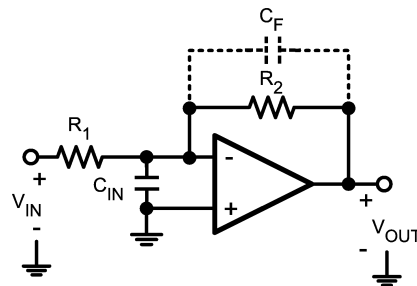

$$A_V = - \frac{V_{OUT}}{V_{IN}} = - \frac{R_2}{R_1}$$

20183664

FIGURE 3. Compensating for Input Capacitance

Application Information (Continued)

For the time being, ignore C_F . The AC gain of the circuit in *Figure 3* can be calculated as follows:

$$\frac{V_{OUT}}{V_{IN}}(s) = \frac{-R_2/R_1}{1 + \frac{s}{\left(\frac{A_0 R_1}{R_1 + R_2}\right)} + \frac{s^2}{\left(\frac{A_0}{C_{IN} R_2}\right)}} \quad (1)$$

This equation is rearranged to find the location of the two poles:

$$P_{1,2} = \frac{-1}{2C_{IN}} \left[\frac{1}{R_1} + \frac{1}{R_2} \pm \sqrt{\left(\frac{1}{R_1} + \frac{1}{R_2}\right)^2 - \frac{4 A_0 C_{IN}}{R_2}} \right] \quad (2)$$

As shown in *Equation (2)*, as the values of R_1 and R_2 are increased, the magnitude of the poles are reduced, which in turn decreases the bandwidth of the amplifier. *Figure 4* shows the frequency response with different value resistors for R_1 and R_2 . Whenever possible, it is best to chose smaller feedback resistors.

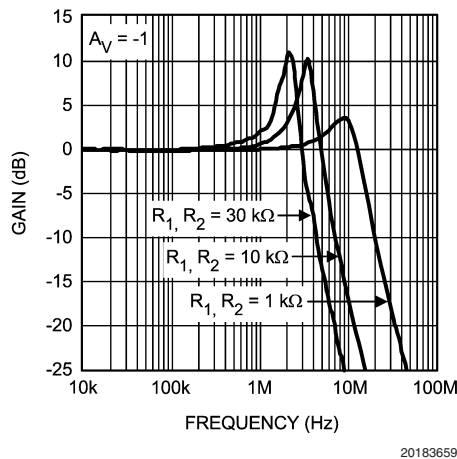

FIGURE 4. Closed Loop Frequency Response

As mentioned before, adding a capacitor to the feedback path will decrease the peaking. This is because C_F will form yet another pole in the system and will prevent pairs of poles, or complex conjugates from forming. It is the presence of pairs of poles that cause the peaking of gain. *Figure 5* shows the frequency response of the schematic presented in *Figure 3* with different values of C_F . As can be seen, using a small value capacitor significantly reduces or eliminates the peaking.

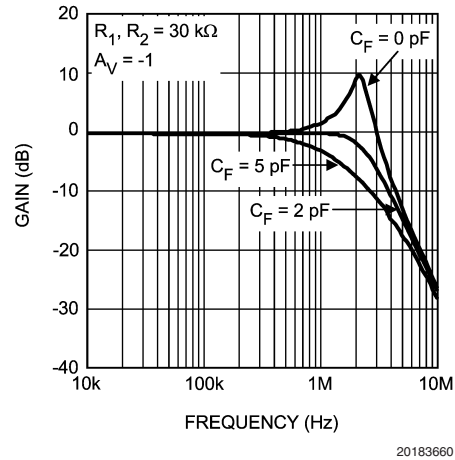

FIGURE 5. Closed Loop Frequency Response

TRANSIMPEDANCE AMPLIFIER

In many applications the signal of interest is a very small amount of current that needs to be detected. Current that is transmitted through a photodiode is a good example. Barcode scanners, light meters, fiber optic receivers, and industrial sensors are some typical applications utilizing photodiodes for current detection. This current needs to be amplified before it can be further processed. This amplification is performed using a current-to-voltage converter configuration or transimpedance amplifier. The signal of interest is fed to the inverting input of an op amp with a feedback resistor in the current path. The voltage at the output of this amplifier will be equal to the negative of the input current times the value of the feedback resistor. *Figure 6* shows a transimpedance amplifier configuration. C_D represents the photodiode parasitic capacitance and C_{CM} denotes the common-mode capacitance of the amplifier. The presence of all of these capacitances at higher frequencies might lead to less stable topologies at higher frequencies. Care must be taken when designing a transimpedance amplifier to prevent the circuit from oscillating.

With a wide gain bandwidth product, low input bias current and low input voltage and current noise, the LMP7715/LMP7716 are ideal for wideband transimpedance applications.

Application Information (Continued)

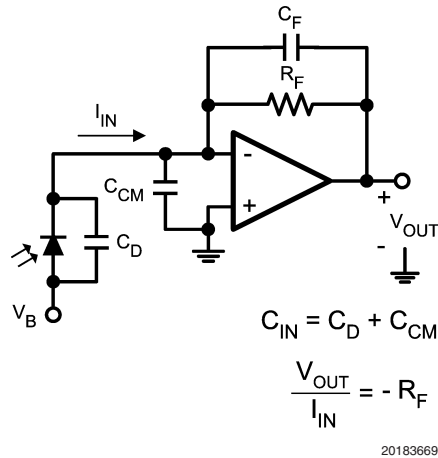

FIGURE 6. Transimpedance Amplifier

A feedback capacitance C_F is usually added in parallel with R_F to maintain circuit stability and to control the frequency response. To achieve a maximally flat, 2nd order response, R_F and C_F should be chosen by using Equation (3)

$$C_F = \sqrt{\frac{C_{IN}}{GBWP * 2 \pi R_F}} \quad (3)$$

Calculating C_F from Equation (3) can sometimes result in capacitor values which are less than 2 pF. This is especially the case for high speed applications. In these instances, it is often more practical to use the circuit shown in Figure 7 in order to allow more sensible choices for C_F . The new feedback capacitor, C_F' , is $(1 + R_B/R_A) C_F$. This relationship holds as long as $R_A \ll R_F$.

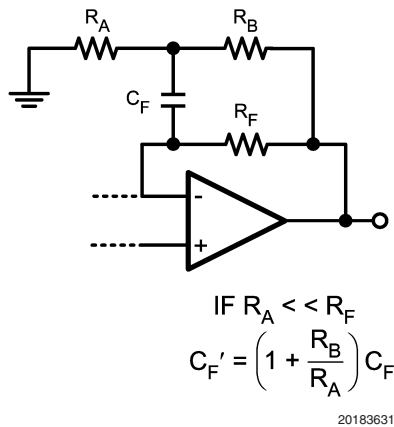

FIGURE 7. Modified Transimpedance Amplifier

SENSOR INTERFACE

The LMP7715/LMP7716 have low input bias current and low input referred noise, which make them ideal choices for sensor interfaces such as thermopiles, Infra Red (IR) thermometry, thermocouple amplifiers, and pH electrode buffers.

Thermopiles generate voltage in response to receiving radiation. These voltages are often only a few microvolts. As a result, the operational amplifier used for this application needs to have low offset voltage, low input voltage noise, and low input bias current. Figure 8 shows a thermopile application where the sensor detects radiation from a distance and generates a voltage that is proportional to the intensity of the radiation. The two resistors, R_A and R_B , are selected to provide high gain to amplify this signal, while C_F removes the high frequency noise.

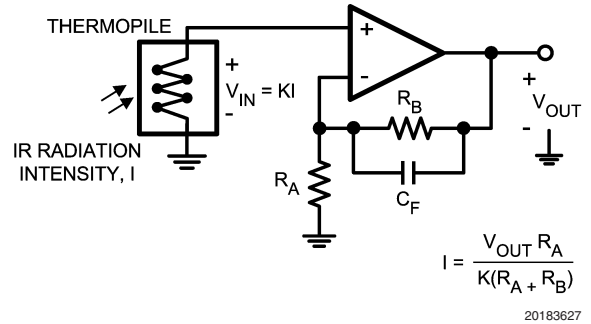

FIGURE 8. Thermopile Sensor Interface

PRECISION RECTIFIER

Rectifiers are electrical circuits used for converting AC signals to DC signals. Figure 9 shows a full-wave precision rectifier. Each operational amplifier used in this circuit has a diode on its output. This means for the diodes to conduct, the output of the amplifier needs to be positive with respect to ground. If V_{IN} is in its positive half cycle then only the output of the bottom amplifier will be positive. As a result, the diode on the output of the bottom amplifier will conduct and the signal will show at the output of the circuit. If V_{IN} is in its negative half cycle then the output of the top amplifier will be positive, resulting in the diode on the output of the top amplifier conducting and delivering the signal from the amplifier's output to the circuit's output.

For $R_2/R_1 \geq 2$, the resistor values can be found by using the equation shown in Figure 9. If $R_2/R_1 = 1$, then R_3 should be left open, no resistor needed, and R_4 should simply be shorted.

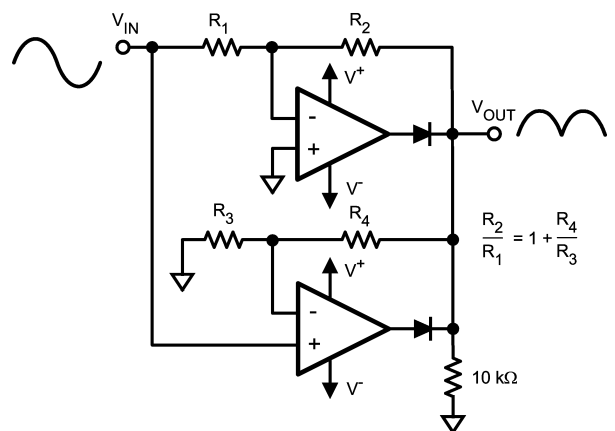
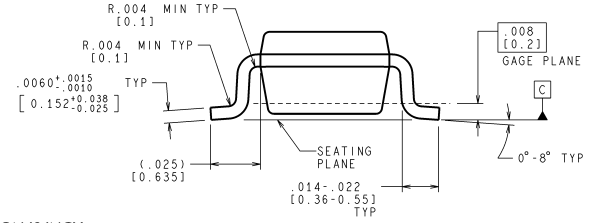
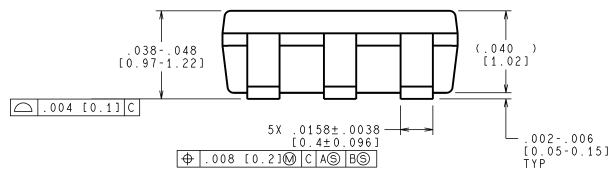
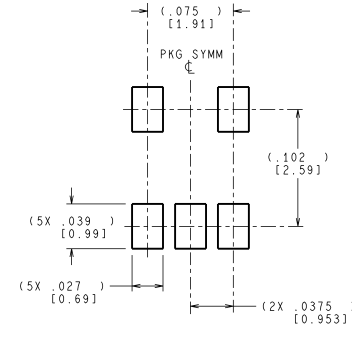
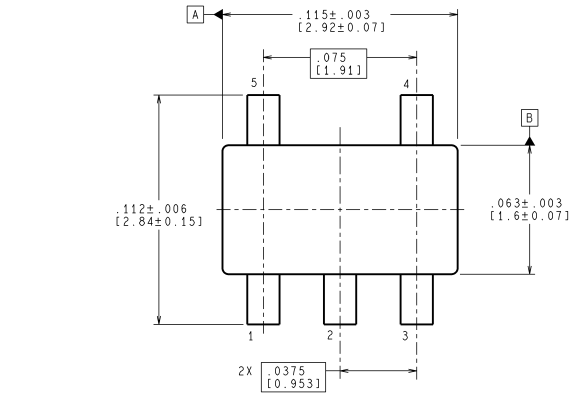

FIGURE 9. Precision Rectifier

Physical Dimensions inches (millimeters) unless otherwise noted



CONTROLLING DIMENSION IS INCH
VALUES IN [] ARE MILLIMETERS
DIMENSIONS IN () FOR REFERENCE ONLY

MF05A (Rev C)

5-Pin SOT23
NS Package Number MF05A

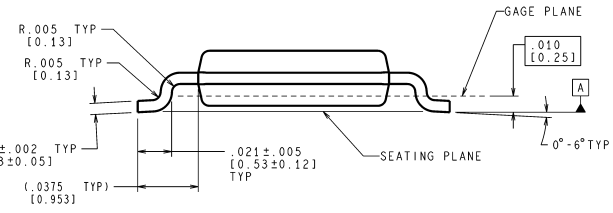
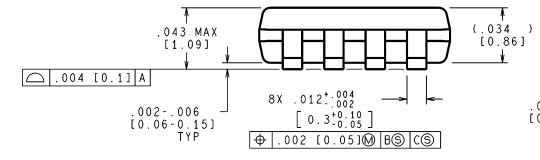
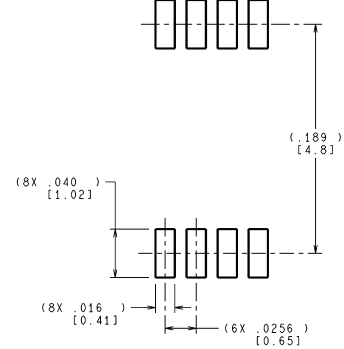
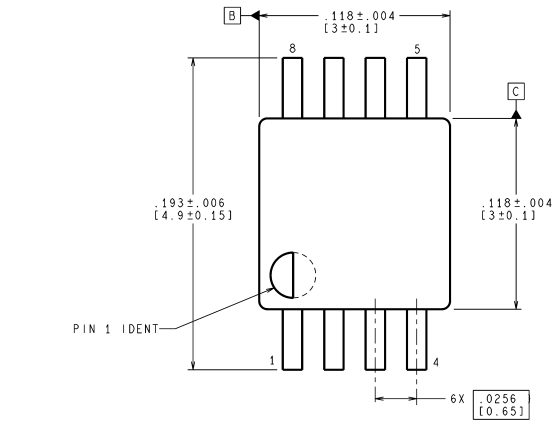

CONTROLLING DIMENSION IS INCH
VALUES IN [] ARE MILLIMETERS

MUA08A (Rev E)

8-Pin MSOP
NS Package Number MUA08A

Notes

National does not assume any responsibility for use of any circuitry described, no circuit patent licenses are implied and National reserves the right at any time without notice to change said circuitry and specifications.

For the most current product information visit us at www.national.com.

LIFE SUPPORT POLICY

NATIONAL'S PRODUCTS ARE NOT AUTHORIZED FOR USE AS CRITICAL COMPONENTS IN LIFE SUPPORT DEVICES OR SYSTEMS WITHOUT THE EXPRESS WRITTEN APPROVAL OF THE PRESIDENT AND GENERAL COUNSEL OF NATIONAL SEMICONDUCTOR CORPORATION. As used herein:

1. Life support devices or systems are devices or systems which, (a) are intended for surgical implant into the body, or (b) support or sustain life, and whose failure to perform when properly used in accordance with instructions for use provided in the labeling, can be reasonably expected to result in a significant injury to the user.
2. A critical component is any component of a life support device or system whose failure to perform can be reasonably expected to cause the failure of the life support device or system, or to affect its safety or effectiveness.

BANNED SUBSTANCE COMPLIANCE

National Semiconductor manufactures products and uses packing materials that meet the provisions of the Customer Products Stewardship Specification (CSP-9-111C2) and the Banned Substances and Materials of Interest Specification (CSP-9-111S2) and contain no "Banned Substances" as defined in CSP-9-111S2.

Leadfree products are RoHS compliant.



National Semiconductor
Americas Customer
Support Center
Email: new.feedback@nsc.com
Tel: 1-800-272-9959

www.national.com

National Semiconductor
Europe Customer Support Center
Fax: +49 (0) 180-530 85 86
Email: europe.support@nsc.com
Deutsch Tel: +49 (0) 69 9508 6208
English Tel: +44 (0) 870 24 0 2171
Français Tel: +33 (0) 1 41 91 8790

National Semiconductor
Asia Pacific Customer
Support Center
Email: ap.support@nsc.com

National Semiconductor
Japan Customer Support Center
Fax: 81-3-5639-7507
Email: jpn.feedback@nsc.com
Tel: 81-3-5639-7560