

LP2983

Micropower 150 mA Voltage Regulator in SOT-23 Package For Output Voltages $\leq 1.2V$

Designed for Use with Very Low ESR Output Capacitors

General Description

The LP2983 is a 150 mA, fixed-output voltage regulator designed to provide tight voltage regulation in applications with output voltages $\leq 1.2V$.

Using an optimized VIP™ (Vertically Integrated PNP) process, the LP2983 delivers unequalled performance in all critical specifications:

Ground Pin Current: Typically 825 μA @ 150 mA load, and 75 μA @ 1 mA load.

Enhanced Stability: The LP2983 is stable with output capacitor ESR down to zero, which allows the use of ceramic capacitors on the output.

Smallest Possible Size: SOT-23 package uses absolute minimum board space.

Precision Output: 1% tolerance output voltages available (A grade).

Features

- Guaranteed 150 mA output current
- Smallest possible size (SOT-23 package)
- Requires minimum external components
- Stable with low-ESR output capacitor
- Low ground pin current at all loads
- Output voltage accuracy 1% (A Grade)
- High peak current capability
- Wide supply voltage range (16V max)
- Low Z_{OUT} : 0.3 Ω typical (10 Hz to 1 MHz)
- Overtemperature/overcurrent protection
- $-40^{\circ}C$ to $+125^{\circ}C$ junction temperature range

Applications

- Cellular Phone
- Palmtop/Laptop Computer
- Personal Digital Assistant (PDA)
- Camcorder, Personal Stereo, Camera

Block Diagram

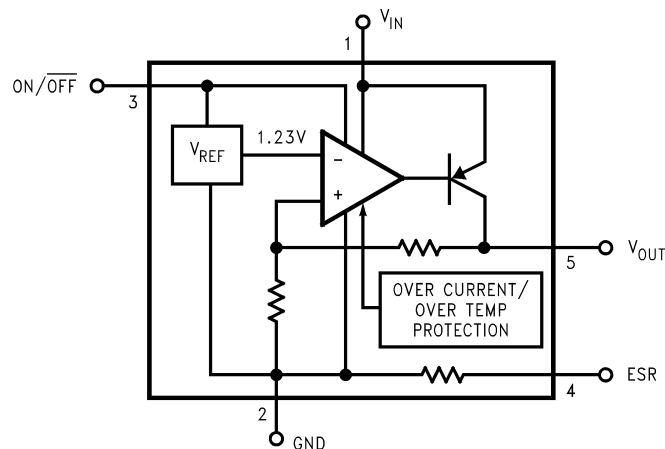

20029101

Basic Application Circuit

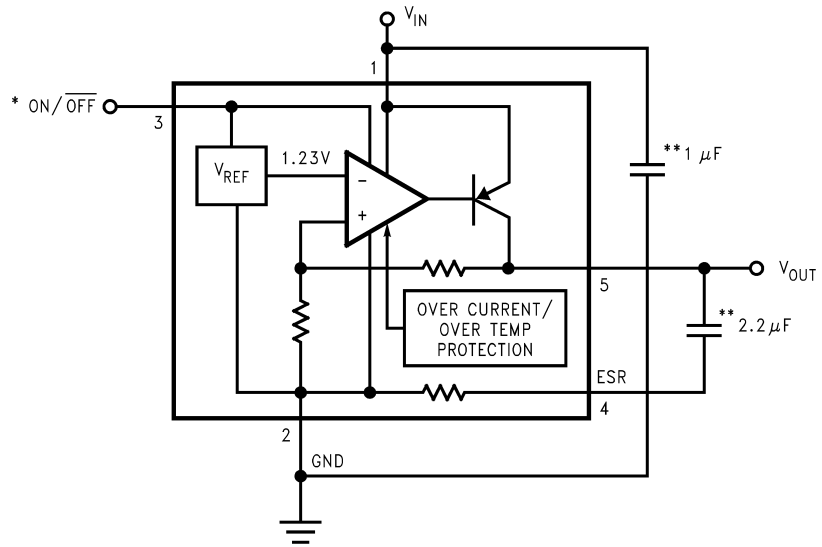

20029102

*ON/OFF input must be actively terminated. Tie to V_{IN} if this function is not to be used.

**Minimum capacitance is shown to ensure stability (may be increased without limit). Ceramic capacitor required for output (see Application Hints).

Connection Diagram

5-Lead Small Outline Package (M5)

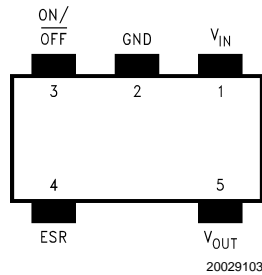

20029103

Top View
See NS Package Number MF05A
For ordering information see Table 1

Ordering Information

TABLE 1. Package Marking and Ordering Information

Output Voltage (V)	Grade	Order Information	Package Marking	Supplied as:
0.9	A	LP2983AIM5X-0.9	LEJA	3000 Units on Tape and Reel
0.9	A	LP2983AIM5-0.9	LEJA	1000 Units on Tape and Reel
0.9	STD	LP2983IM5X-0.9	LEJB	3000 Units on Tape and Reel
0.9	STD	LP2983IM5-0.9	LEJB	1000 Units on Tape and Reel
1.0	A	LP2983AIM5X-1.0	LENA	3000 Units on Tape and Reel
1.0	A	LP2983AIM5-1.0	LENA	1000 Units on Tape and Reel
1.0	STD	LP2983IM5X-1.0	LENB	3000 Units on Tape and Reel
1.0	STD	LP2983IM5-1.0	LENB	1000 Units on Tape and Reel
1.2	A	LP2983AIM5X-1.2	LELA	3000 Units on Tape and Reel
1.2	A	LP2983AIM5-1.2	LELA	1000 Units on Tape and Reel
1.2	STD	LP2983IM5X-1.2	LELB	3000 Units on Tape and Reel
1.2	STD	LP2983IM5-1.2	LELB	1000 Units on Tape and Reel

Absolute Maximum Ratings (Note 1)

If Military/Aerospace specified devices are required, please contact the National Semiconductor Sales Office/Distributors for availability and specifications.

Storage Temperature Range	-65°C to +150°C
Operating Junction Temperature Range	-40°C to +125°C
Lead Temp. (Soldering, 5 sec.)	260°C
ESD Rating (Note 2)	2 kV

Power Dissipation (Note 3)

Input Supply Voltage (Survival)	-0.3V to +16V	Internally Limited
Input Supply Voltage (Operating)	2.2V to +16V	
Shutdown Input Voltage (Survival)	-0.3V to +16V	
Output Voltage Survival, (Note 4)	-0.3V to +9V	
I _{OUT} (Survival)	Short Circuit Protected	
Input-Output Voltage Survival, (Note 5)	-0.3V to +16V	

Electrical Characteristics

Limits in standard typeface are for T_J = 25°C. and limits in **boldface type** apply over the full operating temperature range. Unless otherwise specified: V_{IN} = V_O(NOM) + 1V, I_L = 1 mA, C_{IN} = 1 μF, C_{OUT} = 2.2 μF, V_{ON/OFF} = 2V.

Symbol	Parameter	Conditions	Typ	LP2983AI-X.X (Note 6)		LP2983I-X.X (Note 6)		Units
				Min	Max	Min	Max	
ΔV _O	Output Voltage Tolerance			-1.0	1.0	-1.5	1.5	%
		1 mA ≤ I _L ≤ 50 mA		-2.0	2.0	-2.5	2.5	
		1 mA ≤ I _L ≤ 150 mA		-2.5	2.5	-3.0	3.0	
				-2.5	2.5	-3.5	3.5	
				-3.5	3.5	-4.0	4.0	
$\frac{\Delta V_O}{\Delta V_{IN}}$	Output Voltage Line Regulation	V _O (NOM)+1V ≤ V _{IN} ≤ 16V	0.01		0.016		0.016	%/V
					0.032		0.032	
I _{GND}	Ground Pin Current	I _L = 0	65		95		95	μA
					125		125	
		I _L = 1 mA	75		110		110	
					170		170	
		I _L = 10 mA	120		220		220	
					400		400	
		I _L = 50 mA	300		500		500	
			900		900			
		I _L = 150 mA	825		1200		1500	
					2000		2000	
		V _{ON/OFF} < 0.15V	6		12		12	
		V _{ON/OFF} < 0.05V	0.2		2		2	
V _{IN} (min)	Minimum V _{IN} required to maintain Output Regulation		2.05		2.20		2.20	V
V _{ON/OFF}	ON/OFF Input Voltage (Note 7)	High = O/P ON	1.4	1.6		1.6		
		Low = O/P OFF	0.1		0.05		0.05	
I _{ON/OFF}	ON/OFF Input Current	V _{ON/OFF} = 0	0.01		-2		-2	μA
		V _{ON/OFF} = 5V	5		15		15	
e _n	Output Noise Voltage (RMS)	BW = 10 Hz to 100 kHz, C _{OUT} = 10 μF V _{OUT} = 1.2V	60					μV
$\frac{\Delta V_{OUT}}{\Delta V_{IN}}$	Ripple Rejection	f = 1 kHz C _{OUT} = 2.2 μF	65					dB
I _O (SC)	Short Circuit Current	R _L = 0 (Steady State) (Note 8)	400					mA
I _O (PK)	Peak Output Current	V _{OUT} ≥ V _O (NOM) -5%	250					

Electrical Characteristics (Continued)

Note 1: "Absolute Maximum Ratings" indicate limits beyond which damage to the component may occur. Electrical specifications do not apply when operating the device outside of its rated operating conditions.

Note 2: The ESD rating of pin 3 is 1 kV.

Note 3: The maximum allowable power dissipation is a function of the maximum junction temperature, $T_J(\text{MAX})$, the junction-to-ambient thermal resistance, θ_{J-A} , and the ambient temperature, T_A . The maximum allowable power dissipation at any ambient temperature is calculated using:

$$P(\text{MAX}) = \frac{T_J(\text{MAX}) - T_A}{\theta_{J-A}}$$

Where the value of θ_{J-A} for the SOT-23 package is 240°C/W in a typical PC board mounting. Exceeding the maximum allowable dissipation will cause excessive die temperature, and the regulator will go into thermal shutdown.

Note 4: If used in a dual-supply system where the regulator load is returned to a negative supply, the LP2983 output must be diode-clamped to ground.

Note 5: The output PNP structure contains a diode between the V_{IN} to V_{OUT} terminals that is normally reverse-biased. Reversing the polarity from V_{IN} to V_{OUT} will turn on this diode and possibly cause a destructive latch-up condition (see Application Hints).

Note 6: Limits are 100% production tested at 25°C. Limits over the operating temperature range are guaranteed through correlation using Statistical Quality Control (SQC) methods. The limits are used to calculate National's Average Outgoing Quality Level (AOQL).

Note 7: The ON/OFF input must be properly driven to prevent possible misoperation. For details, refer to Application Hints.

Note 8: The LP2983 has foldback current limiting which allows a high peak current when $V_{OUT} > 0.5V$, and then reduces the maximum output current as V_{OUT} is forced down to ground (see Typical Performance Characteristics curves).

Typical Performance Characteristics Unless otherwise specified: $C_{IN} = 1\mu F$, $C_{OUT} = 2.2\mu F$, $V_{IN} = V_{OUT(NOM)} + 1$, $T_A = 25^\circ C$, ON/OFF pin is tied to V_{IN} .

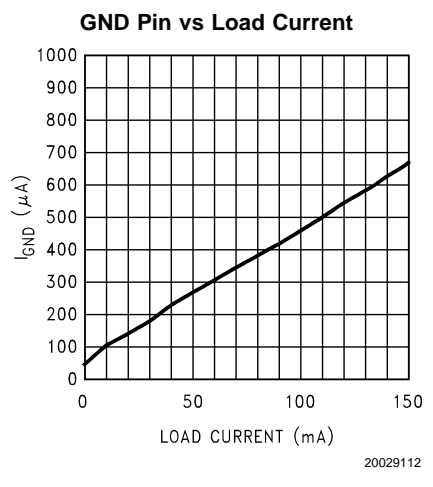
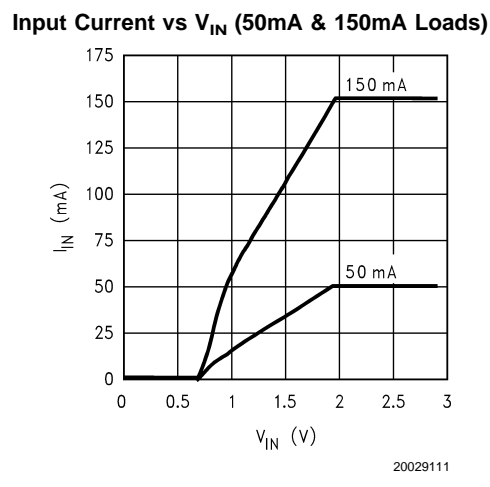
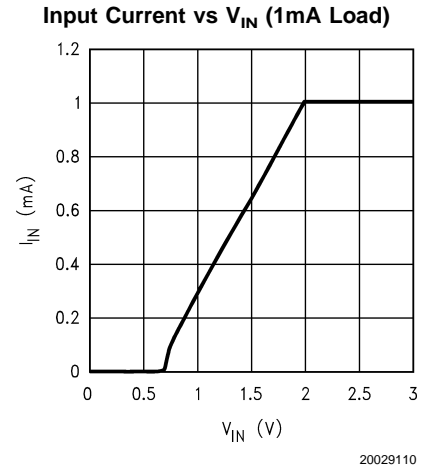
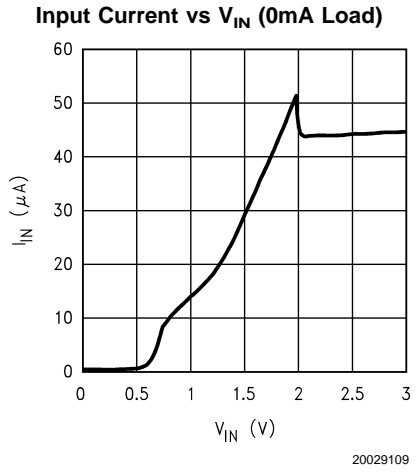
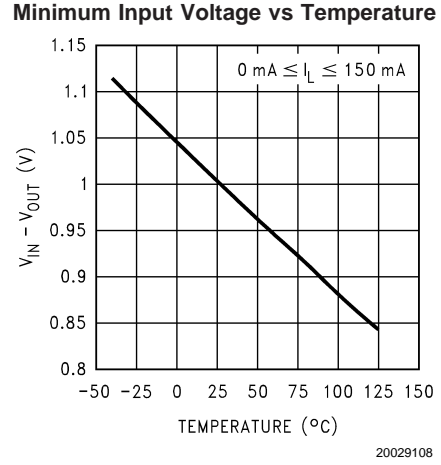
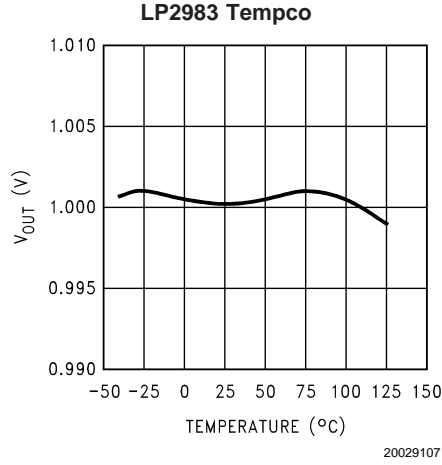

Typical Performance Characteristics Unless otherwise specified: $C_{IN} = 1\mu F$, $C_{OUT} = 2.2\mu F$, $V_{IN} = V_{OUT(NOM)} + 1$, $T_A = 25^\circ C$, ON/OFF pin is tied to V_{IN} . (Continued)

GND Pin vs Temperature and Load

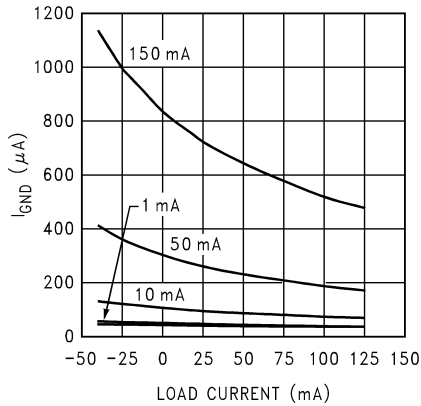

Line Transient Response

$\Delta V_{IN} = 1V$, Load = 1mA

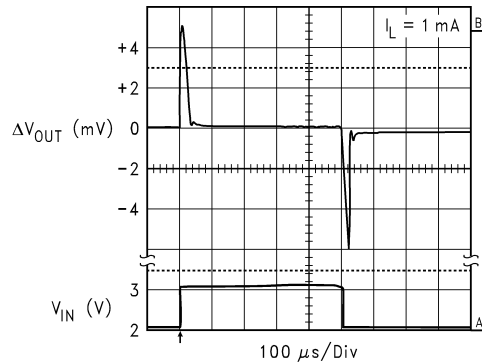

Line Transient Response

$\Delta V_{IN} = 1V$, Load = 150mA

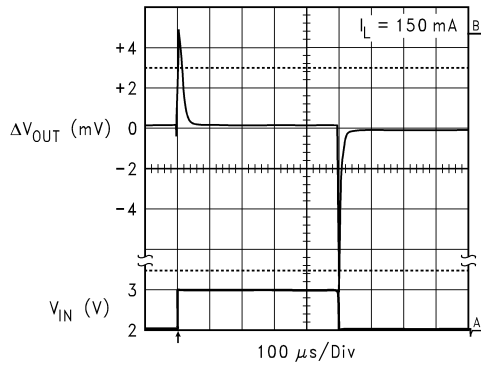

Line Transient Response

$\Delta V_{IN} = 13.8V$, Load = 1mA

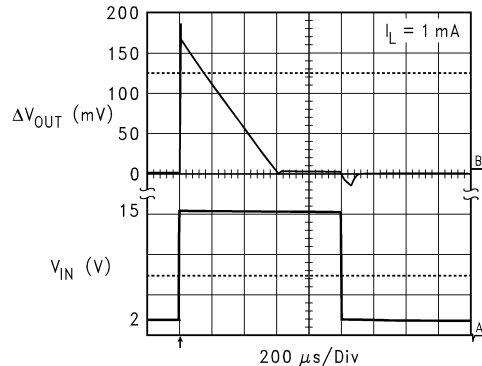

Line Transient Response

$\Delta V_{IN} = 13.8V$, Load = 150mA

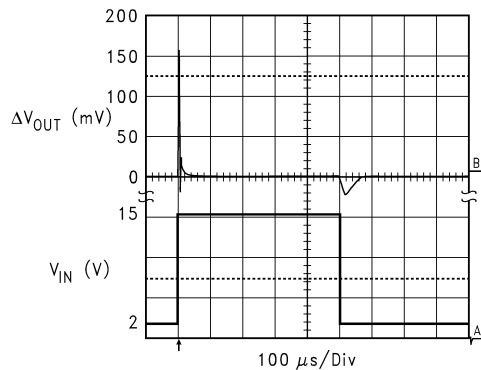

Noise Density

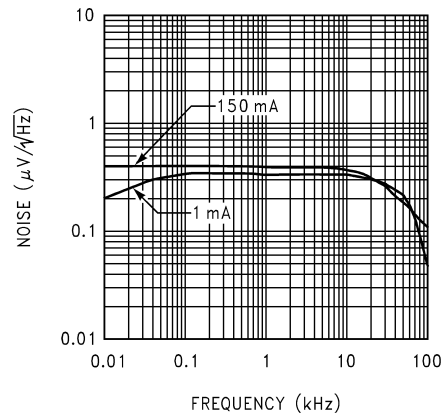

Typical Performance Characteristics Unless otherwise specified: $C_{IN} = 1\mu F$, $C_{OUT} = 2.2\mu F$, $V_{IN} = V_{OUT(NOM)} + 1$, $T_A = 25^\circ C$, ON/OFF pin is tied to V_{IN} . (Continued)

Ripple Rejection $C_{OUT} = 2.2\mu F$

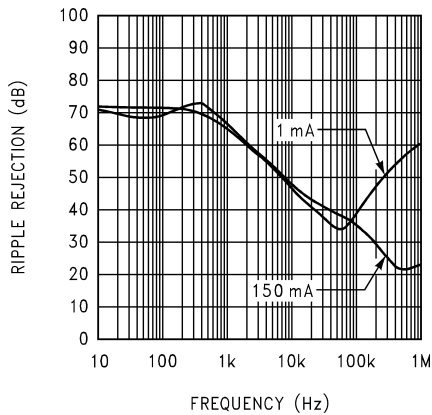

20029119

Turn-On Time

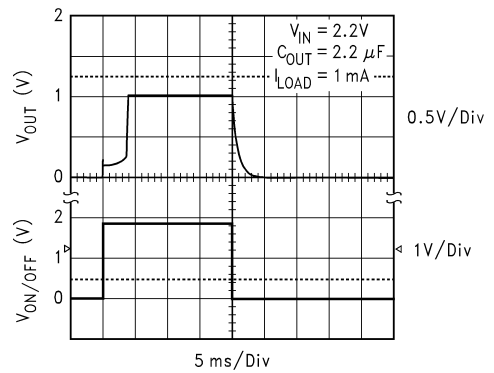

20029121

Short Circuit Current vs Temperature

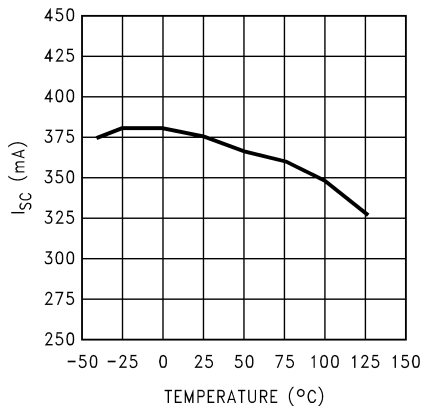

20029127

Short Circuit Current, $V_{IN} = 16V$

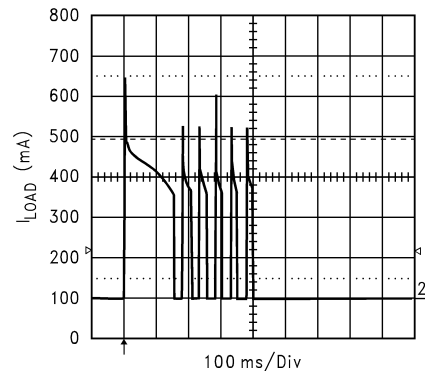

20029122

Short Circuit Current, $V_{IN} = 2.8V$

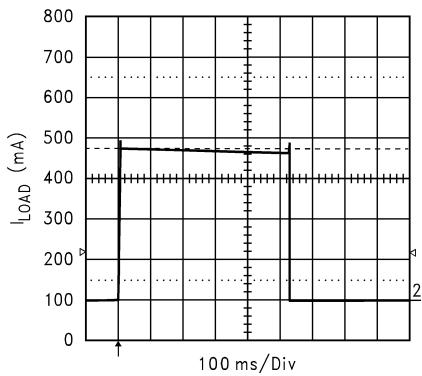

20029123

Short Circuit Current, $V_{IN} = 6V$

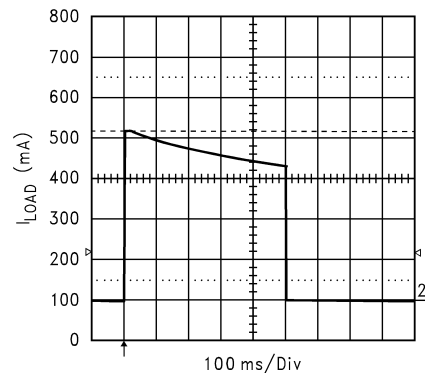

20029124

Typical Performance Characteristics Unless otherwise specified: $C_{IN} = 1\mu F$, $C_{OUT} = 2.2\mu F$, $V_{IN} = V_{OUT(NOM)} + 1$, $T_A = 25^\circ C$, ON/OFF pin is tied to V_{IN} . (Continued)

Load Transient Response
 $C_{OUT} = 4.7\mu F$

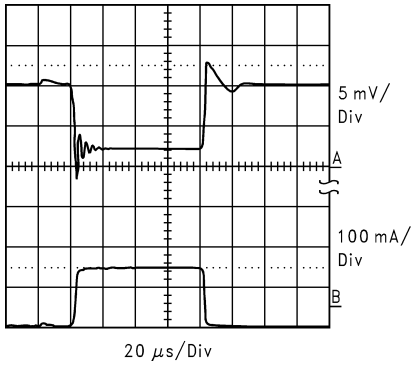

20029125

Load Transient Response
 $C_{OUT} = 2.2\mu F$

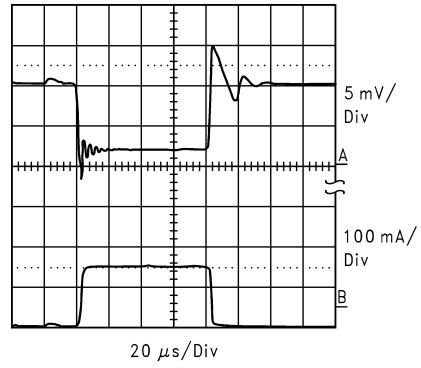

20029126

Application Hints

EXTERNAL CAPACITORS

Like any low-dropout regulator, the LP2983 requires external capacitors for regulator stability. These capacitors must be correctly selected for good performance.

Input Capacitor

An input capacitor whose capacitance is $\geq 1 \mu\text{F}$ is required between the LP2983 input and ground (the amount of capacitance may be increased without limit).

This capacitor must be located a distance of not more than 1 cm from the input pin and returned to a clean analog ground. Any good quality ceramic, tantalum, or film capacitor may be used at the input.

Important: Tantalum capacitors can suffer catastrophic failure due to surge current when connected to a low-impedance source of power (like a battery or very large capacitor). If a Tantalum capacitor is used at the input, it must be guaranteed by the manufacturer to have a surge current rating sufficient for the application.

There are no requirements for ESR on the input capacitor, but tolerance and temperature coefficient must be considered when selecting the capacitor to ensure the capacitance will be $\geq 1 \mu\text{F}$ over the entire operating temperature range.

Output Capacitor

The LP2983 is designed specifically to work with ceramic output capacitors, utilizing circuitry which allows the regulator to be stable across the entire range of output current with an output capacitor whose ESR is as low as zero ohms. See Figure 1 below.

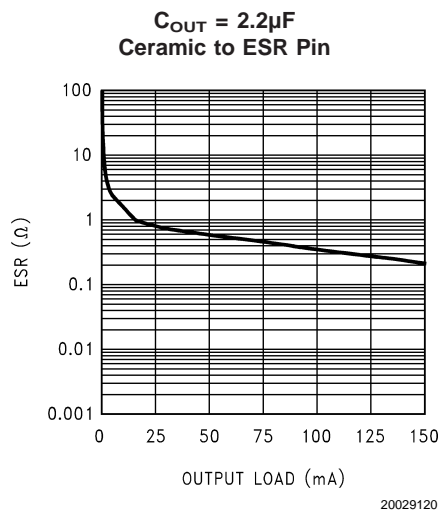

FIGURE 1.

The LP2983 requires a minimum of $2.2 \mu\text{F}$ on the output (output capacitor size can be increased without limit).

It is important to remember that capacitor tolerance and variation with temperature must be taken into consideration when selecting an output capacitor so that the minimum required amount of output capacitance is provided over the full operating temperature range. It should be noted that

ceramic capacitors can exhibit large changes in capacitance with temperature (see next section, *Capacitor Characteristics*).

The output capacitor must be located not more than 1 cm from the output pin and returned to a clean analog ground.

CAPACITOR CHARACTERISTICS

The LP2983 was designed to work with ceramic capacitors on the output to take advantage of the benefits they offer: for capacitance values in the $2.2 \mu\text{F}$ to $4.7 \mu\text{F}$ range, ceramics are the least expensive and also have the lowest ESR values (which makes them best for eliminating high-frequency noise).

One disadvantage of ceramic capacitors is that their capacitance can vary with temperature. Most large value ceramic capacitors ($\geq 2.2 \mu\text{F}$) are manufactured with the Z5U or Y5V temperature characteristic, which results in the capacitance dropping by more than 50% as the temperature goes from 25°C to 85°C .

This could cause problems if a $2.2 \mu\text{F}$ capacitor were used on the output since it will drop down to approximately $1 \mu\text{F}$ at high ambient temperatures (which could cause the LP2983 to oscillate). If Z5U or Y5V capacitors are used on the output, a minimum capacitance value of $4.7 \mu\text{F}$ must be observed.

A better choice for temperature coefficient in ceramic capacitors is X7R, which holds the capacitance within $\pm 15\%$. Unfortunately, the larger values of capacitance are not offered by all manufacturers in the X7R dielectric.

ON/OFF INPUT OPERATION

The LP2983 is shut off by driving the ON/OFF input low, and turned on by pulling it high. If this feature is not to be used, the ON/OFF input should be tied to V_{IN} to keep the regulator output on at all times.

To assure proper operation, the signal source used to drive the ON/OFF input must be able to swing above and below the specified turn-on/turn-off voltage thresholds listed in the Electrical Characteristics section under $V_{\text{ON/OFF}}$. To prevent mis-operation, the turn-on (and turn-off) voltage signals applied to the ON/OFF input must have a slew rate which is $\geq 40 \text{ mV}/\mu\text{s}$.

Caution: the regulator output voltage can not be guaranteed if a slow-moving AC (or DC) signal is applied that is in the range between the specified turn-on and turn-off voltages listed under the electrical specification $V_{\text{ON/OFF}}$ (see Electrical Characteristics).

REVERSE INPUT-OUTPUT VOLTAGE

The PNP power transistor used as the pass element in the LP2983 has an inherent diode connected between the regulator output and input. During normal operation (where the input voltage is higher than the output) this diode is reverse-biased.

However, if the output is pulled above the input, this diode will turn ON and current will flow into the regulator output. In such cases, a parasitic SCR can latch which will allow a high current to flow into V_{IN} (and out the ground pin), which can damage the part.

In any application where the output may be pulled above the input, an external Schottky diode must be connected from V_{IN} to V_{OUT} (cathode on V_{IN} , anode on V_{OUT}), to limit the reverse voltage across the LP2983 to 0.3V (see Absolute Maximum Ratings).

Physical Dimensions inches (millimeters)

unless otherwise noted

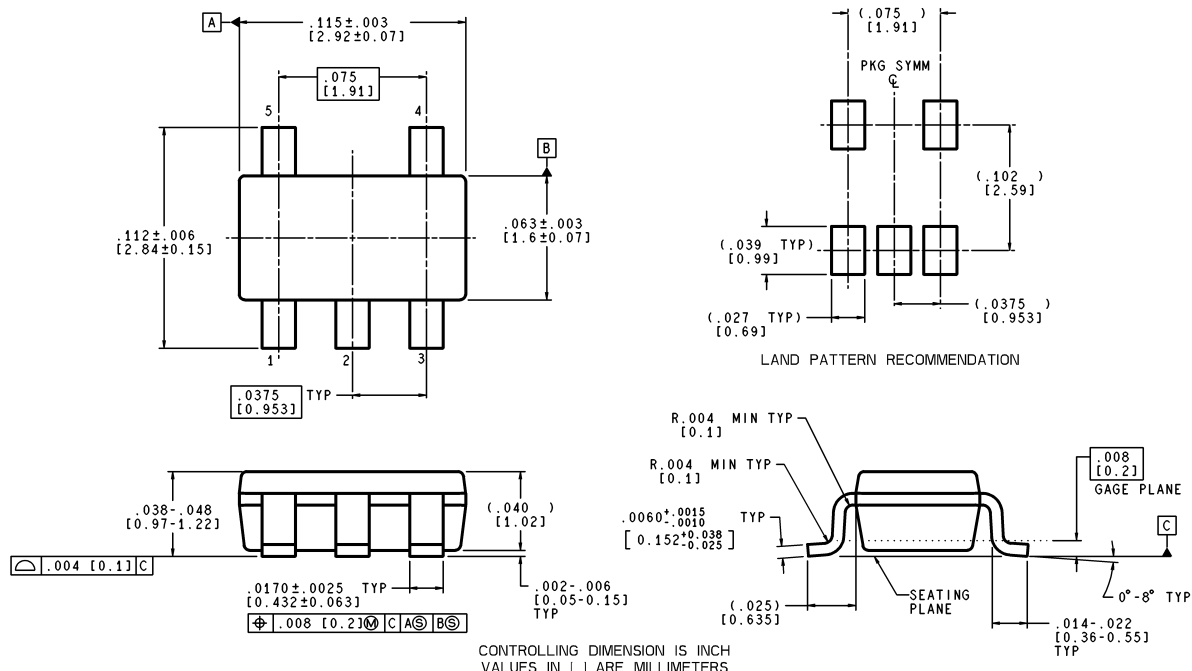

MF05A (Rev A)

5-Lead Small Outline Package (M5)

NS Package Number MF05A

For Order Numbers, refer to *Table 1* in the "Ordering Information" section of this document.

LIFE SUPPORT POLICY

NATIONAL'S PRODUCTS ARE NOT AUTHORIZED FOR USE AS CRITICAL COMPONENTS IN LIFE SUPPORT DEVICES OR SYSTEMS WITHOUT THE EXPRESS WRITTEN APPROVAL OF THE PRESIDENT AND GENERAL COUNSEL OF NATIONAL SEMICONDUCTOR CORPORATION. As used herein:

- Life support devices or systems are devices or systems which, (a) are intended for surgical implant into the body, or (b) support or sustain life, and whose failure to perform when properly used in accordance with instructions for use provided in the labeling, can be reasonably expected to result in a significant injury to the user.
- A critical component is any component of a life support device or system whose failure to perform can be reasonably expected to cause the failure of the life support device or system, or to affect its safety or effectiveness.



National Semiconductor Corporation
Americas
Email: support@nsc.com

National Semiconductor Europe
Fax: +49 (0) 180-530 85 86
Email: europe.support@nsc.com
Deutsch Tel: +49 (0) 69 9508 6208
English Tel: +44 (0) 870 24 0 2171
Français Tel: +33 (0) 1 41 91 8790

National Semiconductor Asia Pacific Customer Response Group
Tel: 65-2544466
Fax: 65-2504466
Email: ap.support@nsc.com

National Semiconductor Japan Ltd.
Tel: 81-3-5639-7560
Fax: 81-3-5639-7507

www.national.com