

LP2986

Micropower, 200 mA Ultra Low-Dropout Fixed or Adjustable Voltage Regulator

General Description

The LP2986 is a 200 mA precision LDO voltage regulator which offers the designer a higher performance version of the industry standard LP2951.

Using an optimized VIP™ (Vertically Integrated PNP) process, the LP2986 delivers superior performance:

Dropout Voltage: Typically 180 mV @ 200 mA load, and 1 mV @ 1 mA load.

Ground Pin Current: Typically 1 mA @ 200 mA load, and 200 μ A @ 10 mA load.

Sleep Mode: The LP2986 draws less than 1 μ A quiescent current when shutdown pin is pulled low.

Error Flag: The built-in error flag goes low when the output drops approximately 5% below nominal.

Precision Output: The standard product versions available can be pin-strapped (using the internal resistive divider) to provide output voltages of 5.0V, 3.3V, or 3.0V with guaranteed accuracy of 0.5% ("A" grade) and 1% (standard grade) at room temperature.

Features

- Ultra low dropout voltage
- Guaranteed 200 mA output current
- SO-8 and mini-SO8 surface mount packages
- <1 μ A quiescent current when shutdown
- Low ground pin current at all loads
- 0.5% output voltage accuracy ("A" grade)
- High peak current capability (400 mA typical)
- Wide supply voltage range (16V max)
- Overtemperature/overcurrent protection
- -40°C to +125°C junction temperature range

Applications

- Cellular Phone
- Palmtop/Laptop Computer
- Camcorder, Personal Stereo, Camera

Block Diagram

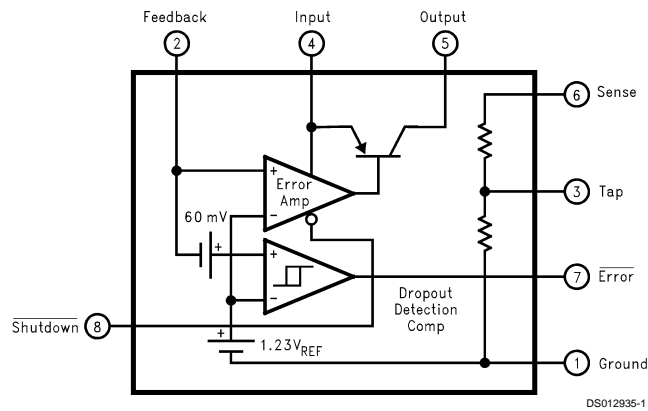

VIP™ is a trademark of National Semiconductor Corporation.

Connection Diagram and Ordering Information

Surface Mount Packages:
 Mini SO-8 Package Type MM: See NS Package Drawing Number MUA08A
 SO-8 Package Type M: See NS Package Drawing Number M08A

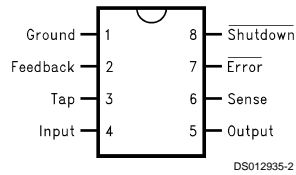

Top View

For ordering information, refer to Table 1 of this document.

Basic Application Circuits

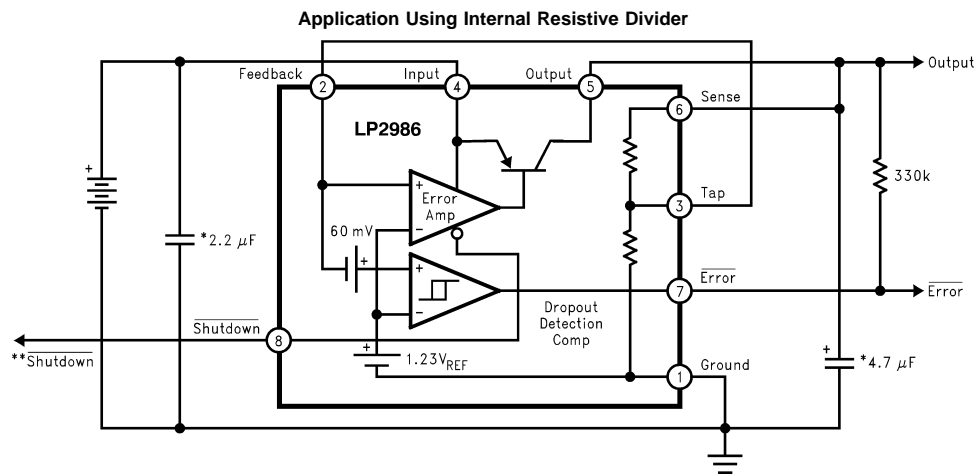

* Minimum capacitance shown to assure stability, but may be increased without limit. Larger output capacitor provides improved dynamic response.

** Shutdown input must be actively terminated. Tie to V_{IN} if not used.

Basic Application Circuits (Continued)

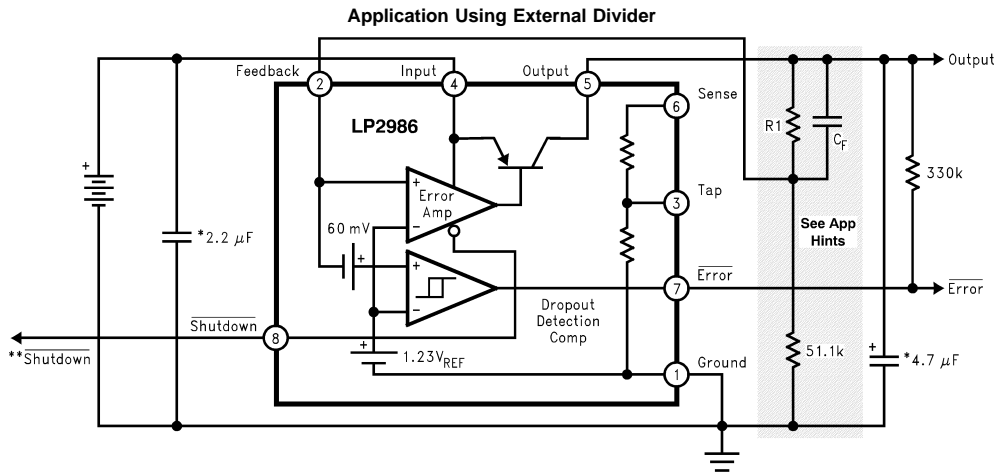

* Minimum capacitance shown to assure stability, but may be increased without limit. Larger output capacitor provides improved dynamic response.

** Shutdown input must be actively terminated. Tie to V_{IN} if not used.

DS012935-4

Ordering Information

TABLE 1. Package Marking and Ordering Information

Output Voltage	Grade	Order Information	Package Marking	Supplied as:
5	A	LP2986AIMMX-5.0	L41A	3.5k Units on Tape and Reel
5	A	LP2986AIMMX-5.0	L41A	250 Units on Tape and Reel
5	STD	LP2986IMMX-5.0	L41B	3.5k Units on Tape and Reel
5	STD	LP2986IMMX-5.0	L41B	250 Units on Tape and Reel
3.3	A	LP2986AIMMX-3.3	L40A	3.5k Units on Tape and Reel
3.3	A	LP2986AIMMX-3.3	L40A	250 Units on Tape and Reel
3.3	STD	LP2986IMMX-3.3	L40B	3.5k Units on Tape and Reel
3.3	STD	LP2986IMMX-3.3	L40B	250 Units on Tape and Reel
3.0	A	LP2986AIMMX-3.0	L39A	3.5k Units on Tape and Reel
3.0	A	LP2986AIMMX-3.0	L39A	250 Units on Tape and Reel
3.0	STD	LP2986IMMX-3.0	L39B	3.5k Units on Tape and Reel
3.0	STD	LP2986IMMX-3.0	L39B	250 Units on Tape and Reel
5	A	LP2986AIMX-5.0	2986AIM5.0	2.5k Units on Tape and Reel
5	A	LP2986AIMX-5.0	2986AIM5.0	Shipped in Anti-Static Rails
5	STD	LP2986IMX-5.0	2986IM5.0	2.5k Units on Tape and Reel
5	STD	LP2986IMX-5.0	2986IM5.0	Shipped in Anti-Static Rails
3.3	A	LP2986AIMX-3.3	2986AIM3.3	2.5k Units on Tape and Reel
3.3	A	LP2986AIMX-3.3	2986AIM3.3	Shipped in Anti-Static Rails
3.3	STD	LP2986IMX-3.3	2986IM3.3	2.5k Units on Tape and Reel
3.3	STD	LP2986IMX-3.3	2986IM3.3	Shipped in Anti-Static Rails
3.0	A	LP2986AIMX-3.0	2986AIM3.0	2.5k Units on Tape and Reel
3.0	A	LP2986AIMX-3.0	2986AIM3.0	Shipped in Anti-Static Rails
3.0	STD	LP2986IMX-3.0	2986IM3.0	2.5k Units on Tape and Reel
3.0	STD	LP2986IMX-3.0	2986IM3.0	Shipped in Anti-Static Rails

Absolute Maximum Ratings (Note 1)

If Military/Aerospace specified devices are required, please contact the National Semiconductor Sales Office/Distributors for availability and specifications.

Storage Temperature Range	-65°C to +150°C
Operating Junction Temperature Range	-40°C to +125°C
Lead Temperature (Soldering, 5 seconds)	260°C
ESD Rating (Note 2)	2 kV
Power Dissipation (Note 3)	Internally Limited
Input Supply Voltage (Survival)	-0.3V to +16V

Input Supply Voltage (Operating)	2.1V to +16V
Shutdown Pin	-0.3V to +16V
Feedback Pin	-0.3V to +5V
Output Voltage (Survival) (Note 4)	-0.3V to +16V
I _{OUT} (Survival)	Short Circuit Protected
Input-Output Voltage (Survival) (Note 5)	-0.3V to +16V

Electrical Characteristics

Limits in standard typeface are for T_J = 25°C, and limits in **boldface type** apply over the full operating temperature range. Unless otherwise specified: V_{IN} = V_{O(NOM)} + 1V, I_L = 1 mA, C_{OUT} = 4.7 μF, C_{IN} = 2.2 μF, V_{S/D} = 2V.

Symbol	Parameter	Conditions	Typical	LM2986AI-X.X (Note 6)		LM2986I-X.X (Note 6)		Units
				Min	Max	Min	Max	
V _O	Output Voltage (5.0V Versions)		5.0	4.975	5.025	4.950	5.050	V
		0.1 mA < I _L < 200 mA	5.0	4.960	5.040	4.920	5.080	
	Output Voltage (3.3V Versions)		3.3	3.283	3.317	3.267	3.333	
		0.1 mA < I _L < 200 mA	3.3	3.274	3.326	3.247	3.353	
	Output Voltage (3.0V Versions)		3.0	2.985	3.015	2.970	3.030	
		0.1 mA < I _L < 200 mA	3.0	2.976	3.024	2.952	3.048	
				2.946	3.054	2.916	3.084	
$\frac{V_O}{\Delta V_{IN}}$	Output Voltage Line Regulation	V _{O(NOM)} + 1V ≤ V _{IN} ≤ 16V	0.007		0.014		0.014	%/V
V _{IN} -V _O	Dropout Voltage (Note 7)	I _L = 100 μA	1		2.0		2.0	mV
		I _L = 75 mA	90		120		120	
					170		170	
		I _L = 200 mA	180		230		230	
					350		350	
I _{GND}	Ground Pin Current	I _L = 100 μA	100		120		120	μA
					150		150	
		I _L = 75 mA	500		800		800	mA
					1400		1400	
		I _L = 200 mA	1		2.1		2.1	
					3.7		3.7	
		V _{S/D} < 0.3V	0.05		1.5		1.5	μA
I _{O(PK)}	Peak Output Current	V _{OUT} ≥ V _{O(NOM)} - 5%	400	250		250		mA
I _{O(MAX)}	Short Circuit Current	R _L = 0 (Steady State) (Note 11)	400					mA
e _n	Output Noise Voltage (RMS)	BW = 300 Hz to 50 kHz, C _{OUT} = 10 μF	160					μV(RMS)
$\frac{\Delta V_{OUT}}{\Delta V_{IN}}$	Ripple Rejection	f = 1 kHz, C _{OUT} = 10 μF	65					dB

Electrical Characteristics (Continued)

Limits in standard typeface are for $T_J = 25^\circ\text{C}$, and limits in **boldface type** apply over the full operating temperature range. Unless otherwise specified: $V_{IN} = V_O(\text{NOM}) + 1\text{V}$, $I_L = 1\text{ mA}$, $C_{OUT} = 4.7\ \mu\text{F}$, $C_{IN} = 2.2\ \mu\text{F}$, $V_{S/D} = 2\text{V}$.

Symbol	Parameter	Conditions	Typical	LM2986AI-X.X (Note 6)		LM2986I-X.X (Note 6)		Units
				Min	Max	Min	Max	
$\frac{\Delta V_{OUT}}{\Delta T}$	Output Voltage Temperature Coefficient	(Note 9)	20					ppm/ $^\circ\text{C}$
FEEDBACK PIN								
V_{FB}	Feedback Pin Voltage		1.23	1.21 1.20	1.25 1.26	1.20 1.19	1.26 1.27	V
		(Note 10)	1.23	1.19	1.28	1.18	1.29	
$\frac{\Delta V_{FB}}{\Delta T}$	FB Pin Voltage Temperature Coefficient	(Note 9)	20					ppm/ $^\circ\text{C}$
I_{FB}	Feedback Pin Bias Current	$I_L = 200\text{ mA}$	150		330 760		330 760	nA
$\frac{I_{FB}}{\Delta T}$	FB Pin Bias Current Temperature Coefficient	(Note 9)	0.1					nA/ $^\circ\text{C}$
SHUTDOWN INPUT								
$V_{S/D}$	S/D Input Voltage (Note 8)	$V_H = \text{O/P ON}$ $V_L = \text{O/P OFF}$	1.4 0.55	1.6		1.6	0.18	V
$I_{S/D}$	S/D Input Current	$V_{S/D} = 0$ $V_{S/D} = 5\text{V}$	0 5		-1 15		-1 15	μA
ERROR COMPARATOR								
I_{OH}	Output "HIGH" Leakage	$V_{OH} = 16\text{V}$	0.01		1 2		1 2	μA
V_{OL}	Output "LOW" Voltage	$V_{IN} = V_O(\text{NOM}) - 0.5\text{V}$, $I_O(\text{COMP}) = 300\ \mu\text{A}$	150		220 350		220 350	mV
$V_{THR}(\text{MAX})$	Upper Threshold Voltage		-4.6	-5.5 -7.7	-3.5 -2.5	-5.5 -7.7	-3.5 -2.5	% V_{OUT}
$V_{THR}(\text{MIN})$	Lower Threshold Voltage		-6.6	-8.9 -13.0	-4.9 -3.3	-8.9 -13.0	-4.9 -3.3	
HYST	Hysteresis		2.0					

Note 1: Absolute Maximum Ratings indicate limits beyond which damage to the component may occur. Electrical specifications do not apply when operating the device outside of its rated operating conditions.

Note 2: The ESD rating of the Feedback pin is 500V and the Tap pin is 1.5 kV.

Note 3: The maximum allowable power dissipation is a function of the maximum junction temperature, $T_J(\text{MAX})$, the junction-to-ambient thermal resistance, θ_{J-A} , and the ambient temperature, T_A . The maximum allowable power dissipation at any ambient temperature is calculated using:

$$P(\text{MAX}) = \frac{T_J(\text{MAX}) - T_A}{\theta_{J-A}}$$

The value of θ_{J-A} for the SO-8 (M) package is 160 $^\circ\text{C/W}$, and the mini SO-8 (MM) package is 200 $^\circ\text{C/W}$. Exceeding the maximum allowable power dissipation will cause excessive die temperature, and the regulator will go into thermal shutdown.

Note 4: If used in a dual-supply system where the regulator load is returned to a negative supply, the LM2986 output must be diode-clamped to ground.

Note 5: The output PNP structure contains a diode between the V_{IN} and V_{OUT} terminals that is normally reverse-biased. Forcing the output above the input will turn on this diode and may induce a latch-up mode which can damage the part (see Application Hints).

Note 6: Limits are 100% production tested at 25 $^\circ\text{C}$. Limits over the operating temperature range are guaranteed through correlation using Statistical Quality Control (SQC) methods. The limits are used to calculate National's Average Outgoing Quality Level (AOQL).

Note 7: Dropout voltage is defined as the input to output differential at which the output voltage drops 100 mV below the value measured with a 1V differential.

Note 8: To prevent mis-operation, the Shutdown input must be driven by a signal that swings above V_H and below V_L with a slew rate not less than 40 mV/ μs (see Application Hints).

Note 9: Temperature coefficient is defined as the maximum (worst-case) change divided by the total temperature range.

Note 10: $V_{FB} \leq V_{OUT} \leq (V_{IN} - 1)$, $2.5\text{V} \leq V_{IN} \leq 16\text{V}$, $100\ \mu\text{A} \leq I_L \leq 200\text{ mA}$, $T_J \leq 125^\circ\text{C}$.

Note 11: See Typical Performance Characteristics curves.

Typical Performance Characteristics Unless otherwise specified: $T_A = 25^\circ\text{C}$, $C_{OUT} = 4.7 \mu\text{F}$, $C_{IN} = 2.2 \mu\text{F}$, S/D is tied to V_{IN} , $V_{IN} = V_O(\text{NOM}) + 1\text{V}$, $I_L = 1 \text{mA}$.

V_{OUT} vs Temperature

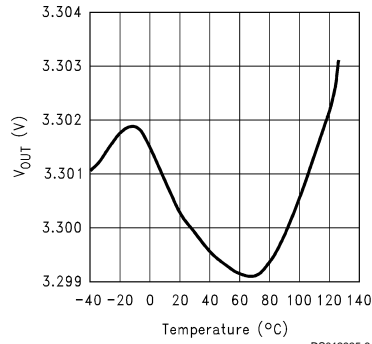

Dropout Voltage vs Temperature

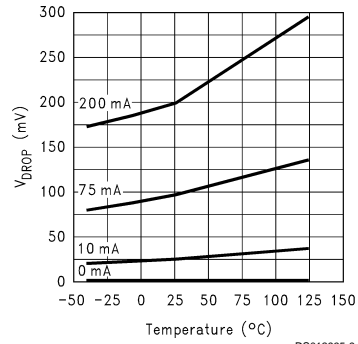

Dropout Voltage vs Load Current

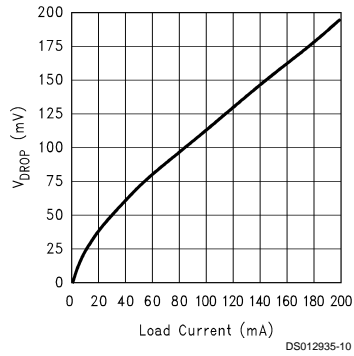

Dropout Characteristics

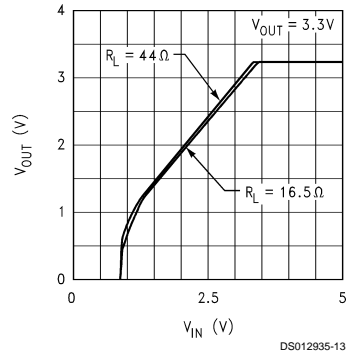

Ground Pin Current vs Temperature and Load

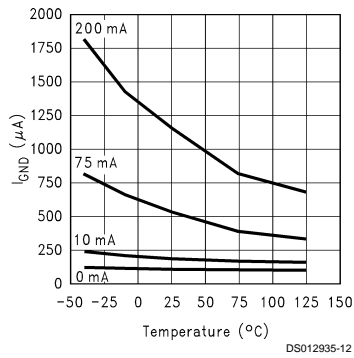

Ground Pin Current vs Load Current

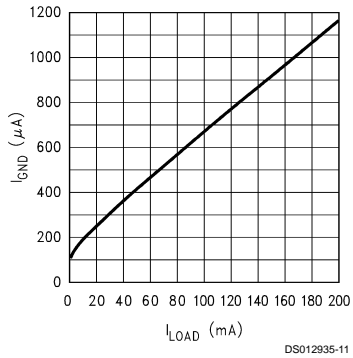

Typical Performance Characteristics Unless otherwise specified: $T_A = 25^\circ\text{C}$, $C_{OUT} = 4.7\ \mu\text{F}$, $C_{IN} = 2.2\ \mu\text{F}$, S/D is tied to V_{IN} , $V_{IN} = V_{O(NOM)} + 1\text{V}$, $I_L = 1\ \text{mA}$. (Continued)

Input Current vs V_{IN}

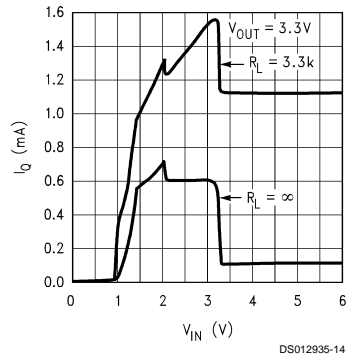

DS012935-14

Input Current vs V_{IN}

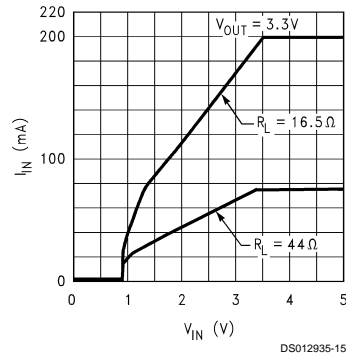

DS012935-15

Load Transient Response

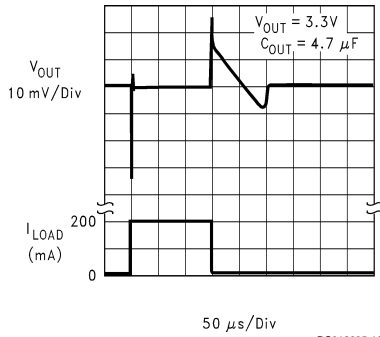

DS012935-16

Load Transient Response

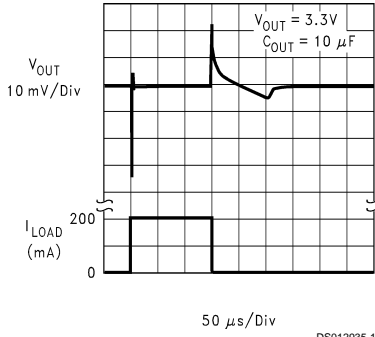

DS012935-17

Line Transient Response

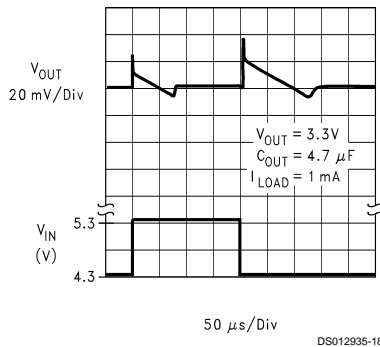

DS012935-18

Line Transient Response

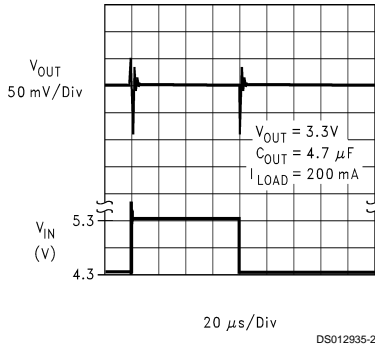

DS012935-20

Typical Performance Characteristics Unless otherwise specified: $T_A = 25^\circ\text{C}$, $C_{OUT} = 4.7 \mu\text{F}$, $C_{IN} = 2.2 \mu\text{F}$, S/D is tied to V_{IN} , $V_{IN} = V_{O(NOM)} + 1\text{V}$, $I_L = 1 \text{mA}$. (Continued)

Turn-On Waveform

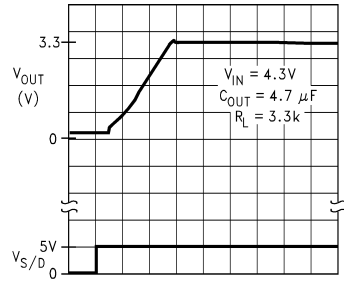

20 $\mu\text{s}/\text{Div}$ DS012935-21

Turn-Off Waveform

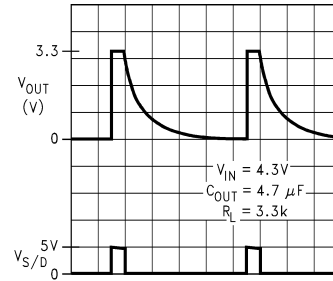

20 ms/Div DS012935-23

Short Circuit Current

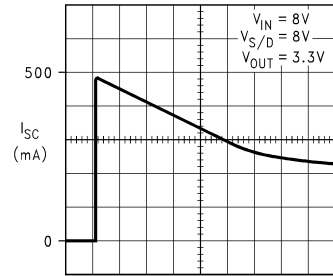

500 ms/Div DS012935-24

Short Circuit Current

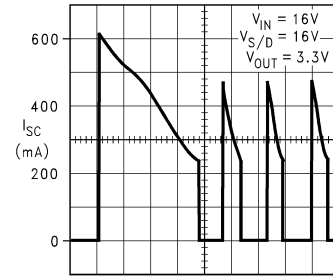

200 ms/Div DS012935-25

Short Circuit Current vs Output Voltage

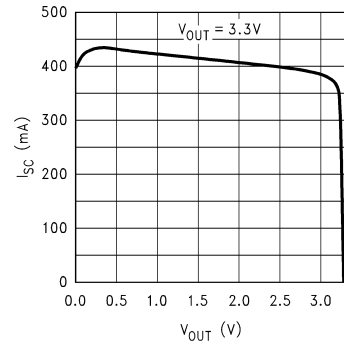

DS012935-26

Instantaneous Short Circuit Current vs Temperature

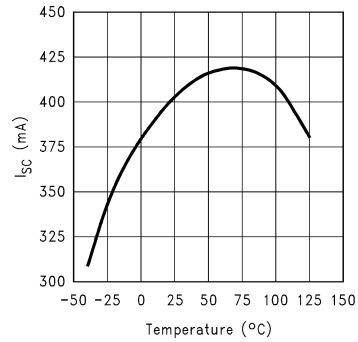

DS012935-27

Typical Performance Characteristics Unless otherwise specified: $T_A = 25^\circ\text{C}$, $C_{OUT} = 4.7 \mu\text{F}$, $C_{IN} = 2.2 \mu\text{F}$, S/D is tied to V_{IN} , $V_{IN} = V_{O(NOM)} + 1\text{V}$, $I_L = 1 \text{mA}$. (Continued)

DC Load Regulation

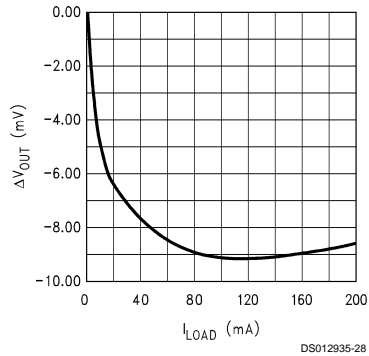

Feedback Bias Current vs Load

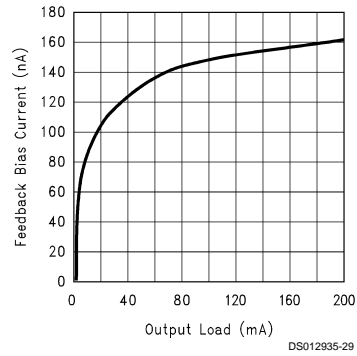

Feedback Bias Current vs Temperature

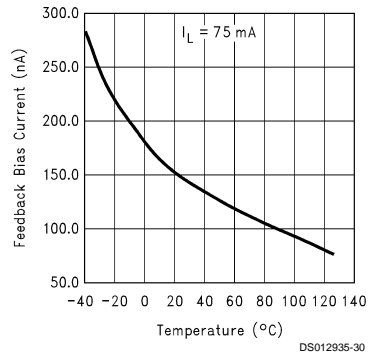

Shutdown Pin Current vs Shutdown Pin Voltage

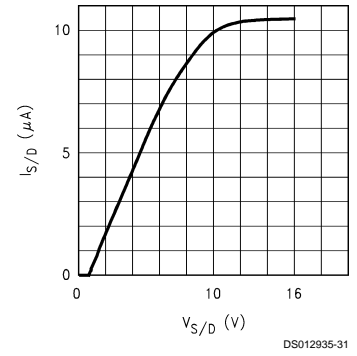

Shutdown Voltage vs Temperature

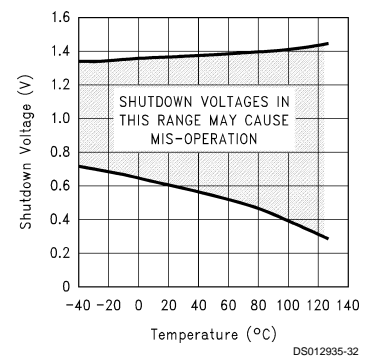

Input to Output Leakage vs Temperature

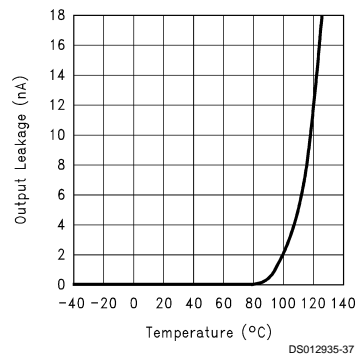

Typical Performance Characteristics Unless otherwise specified: $T_A = 25^\circ\text{C}$, $C_{\text{OUT}} = 4.7 \mu\text{F}$, $C_{\text{IN}} = 2.2 \mu\text{F}$, S/D is tied to V_{IN} , $V_{\text{IN}} = V_{\text{O(NOM)}} + 1\text{V}$, $I_L = 1 \text{ mA}$. (Continued)

Output Noise Density

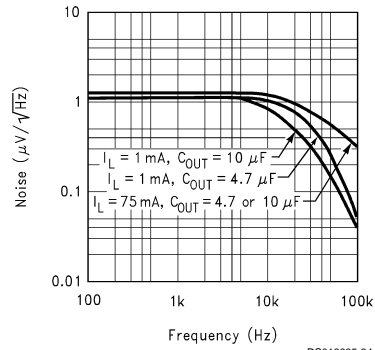

Output Impedance vs Frequency

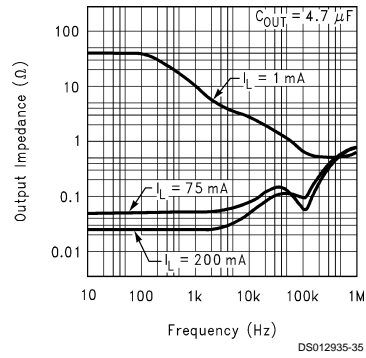

Output Impedance vs Frequency

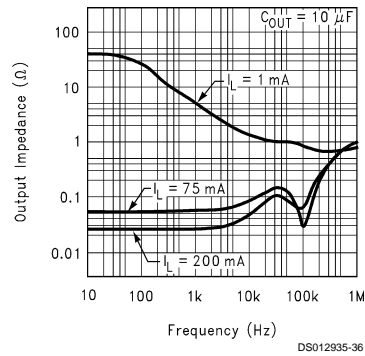

Ripple Rejection

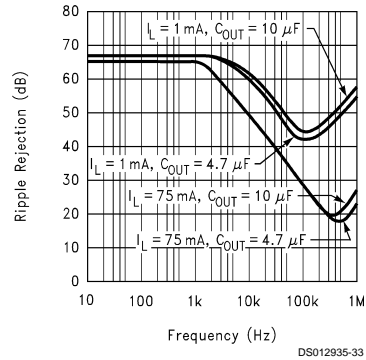

Application Hints

EXTERNAL CAPACITORS

Like any low-dropout regulator, external capacitors are required to assure stability. These capacitors must be correctly selected for proper performance.

INPUT CAPACITOR: An input capacitor ($\geq 2.2 \mu\text{F}$) is required between the LP2986 input and ground (amount of capacitance may be increased without limit).

This capacitor must be located a distance of not more than 0.5" from the input pin and returned to a clean analog ground. Any good quality ceramic or tantalum may be used for this capacitor.

OUTPUT CAPACITOR: The output capacitor must meet the requirement for minimum amount of capacitance and also have an appropriate E.S.R. (equivalent series resistance) value.

Curves are provided which show the allowable ESR range as a function of load current for various output voltages and capacitor values (see ESR curves below).

ESR Curves For 5V Output

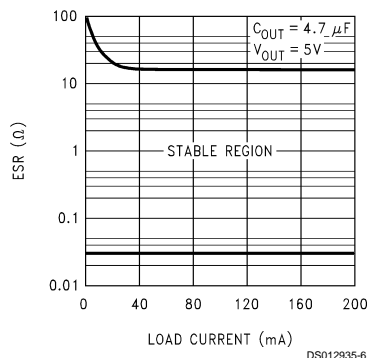

ESR Curves For 2.5V Output

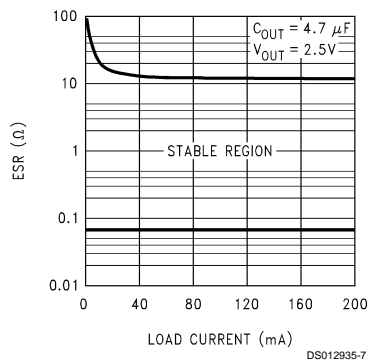

IMPORTANT: The output capacitor must maintain its ESR in the stable region over the full operating temperature range of the application to assure stability.

The minimum required amount of output capacitance is $4.7 \mu\text{F}$. Output capacitor size can be increased without limit.

It is important to remember that capacitor tolerance and variation with temperature must be taken into consideration

when selecting an output capacitor so that the minimum required amount of output capacitance is provided over the full operating temperature range. A good Tantalum capacitor will show very little variation with temperature, but a ceramic may not be as good (see next section).

CAPACITOR CHARACTERISTICS

TANTALUM: The best choice for size, cost, and performance are solid tantalum capacitors. Available from many sources, their typical ESR is very close to the ideal value required on the output of many LDO regulators.

Tantalums also have good temperature stability: a $4.7 \mu\text{F}$ was tested and showed only a 10% decline in capacitance as the temperature was decreased from $+125^\circ\text{C}$ to -40°C . The ESR increased only about 2:1 over the same range of temperature.

However, it should be noted that the increasing ESR at lower temperatures present in all tantalums can cause oscillations when marginal quality capacitors are used (where the ESR of the capacitor is near the upper limit of the stability range at room temperature).

CERAMIC: For a given amount of a capacitance, ceramics are usually larger and more costly than tantalums.

Be warned that the ESR of a ceramic capacitor can be low enough to cause instability: a $2.2 \mu\text{F}$ ceramic was measured and found to have an ESR of about $15 \text{ m}\Omega$.

If a ceramic capacitor is to be used on the LP2986 output, a 1Ω resistor should be placed in series with the capacitor to provide a minimum ESR for the regulator.

Another disadvantage of ceramic capacitors is that their capacitance varies a lot with temperature:

Large ceramic capacitors are typically manufactured with the Z5U temperature characteristic, which results in the capacitance dropping by a 50% as the temperature goes from 25°C to 80°C .

This means you have to buy a capacitor with twice the minimum C_{OUT} to assure stable operation up to 80°C .

ALUMINUM: The large physical size of aluminum electrolytics makes them unattractive for use with the LP2986. Their ESR characteristics are also not well suited to the requirements of LDO regulators.

The ESR of an aluminum electrolytic is higher than a tantalum, and it also varies greatly with temperature.

A typical aluminum electrolytic can exhibit an ESR increase of 50X when going from 20°C to -40°C . Also, some aluminum electrolytics can not be used below -25°C because the electrolyte will freeze.

USING AN EXTERNAL RESISTIVE DIVIDER

The LP2986 output voltage can be programmed using an external resistive divider (see Basic Application Circuits).

The resistor connected between the Feedback pin and ground should be 51.1k . The value for the other resistor (R_1) connected between the Feedback pin and the regulated output is found using the formula:

$$V_{\text{OUT}} = 1.23 \times (1 + R_1/51.1\text{k})$$

It should be noted that the $25 \mu\text{A}$ of current flowing through the external divider is approximately equal to the current saved by not connecting the internal divider, which means the quiescent current is not increased by using external resistors.

Application Hints (Continued)

A lead compensation capacitor (C_F) must also be used to place a zero in the loop response at about 50 kHz. The value for C_F can be found using:

$$C_F = 1/(2\pi \times R1 \times 50k)$$

A good quality capacitor must be used for C_F to ensure that the value is accurate and does not change significantly over temperature. Mica or ceramic capacitors can be used, assuming a tolerance of $\pm 20\%$ or better is selected.

If a ceramic is used, select one with a temperature coefficient of NPO, COG, Y5P, or X7R. Capacitor types Z5U, Y5V, and Z4V can not be used because their value varies more than 50% over the -25°C to $+85^\circ\text{C}$ temperature range.

SHUTDOWN INPUT OPERATION

The LP2986 is shut off by driving the Shutdown input low, and turned on by pulling it high. If this feature is not to be used, the Shutdown input should be tied to V_{IN} to keep the regulator output on at all times.

To assure proper operation, the signal source used to drive the Shutdown input must be able to swing above and below the specified turn-on/turn-off voltage thresholds listed as V_H and V_L , respectively (see Electrical Characteristics).

It is also important that the turn-on (and turn-off) voltage signals applied to the Shutdown input have a slew rate which is not less than 40 mV/ μs .

CAUTION: the regulator output state can not be guaranteed if a slow-moving AC (or DC) signal is applied that is in the range between V_H and V_L .

REVERSE INPUT-OUTPUT VOLTAGE

The PNP power transistor used as the pass element in the LP2986 has an inherent diode connected between the regulator output and input.

During normal operation (where the input voltage is higher than the output) this diode is reverse-biased.

However, if the output is pulled above the input, this diode will turn ON and current will flow into the regulator output.

In such cases, a parasitic SCR can latch which will allow a high current to flow into V_{IN} (and out the ground pin), which can damage the part.

In any application where the output may be pulled above the input, an external Schottky diode must be connected from V_{IN} to V_{OUT} (cathode on V_{IN} , anode on V_{OUT}), to limit the reverse voltage across the LP2986 to 0.3V (see Absolute Maximum Ratings).

Physical Dimensions inches (millimeters) unless otherwise noted

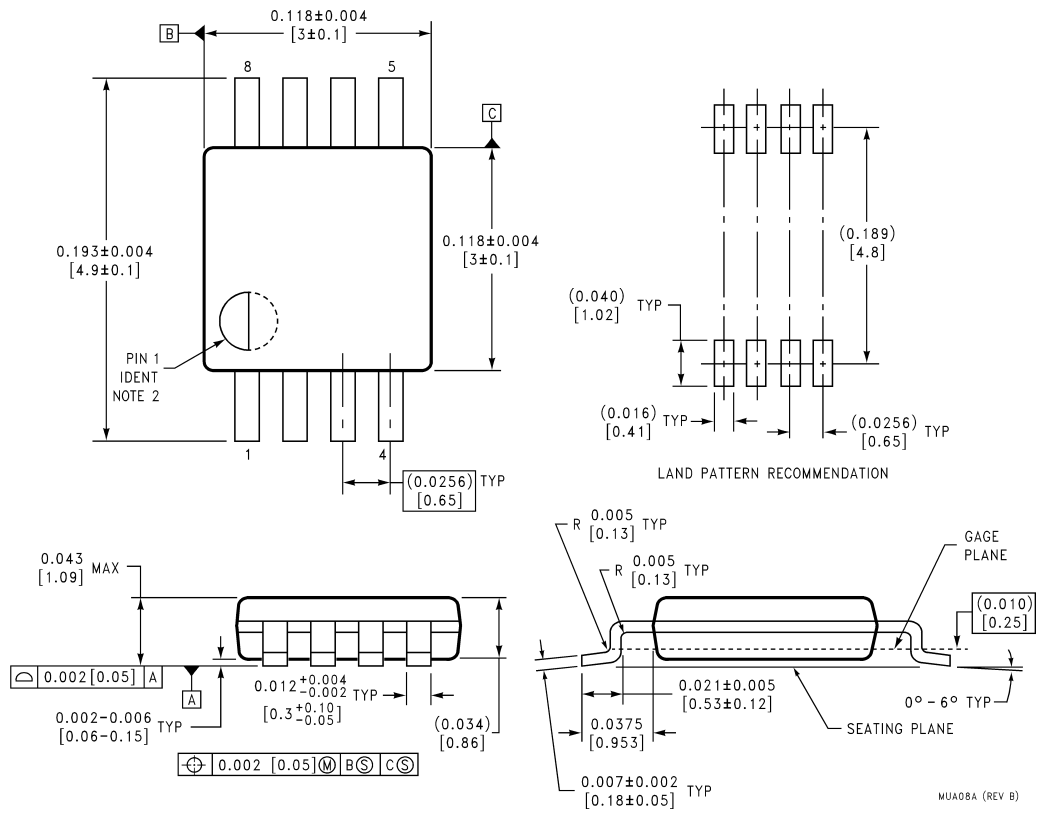

**8-Lead Mini-Small Outline Molded Package, JEDEC
NS Package Number MUA08A**

Physical Dimensions inches (millimeters) unless otherwise noted (Continued)

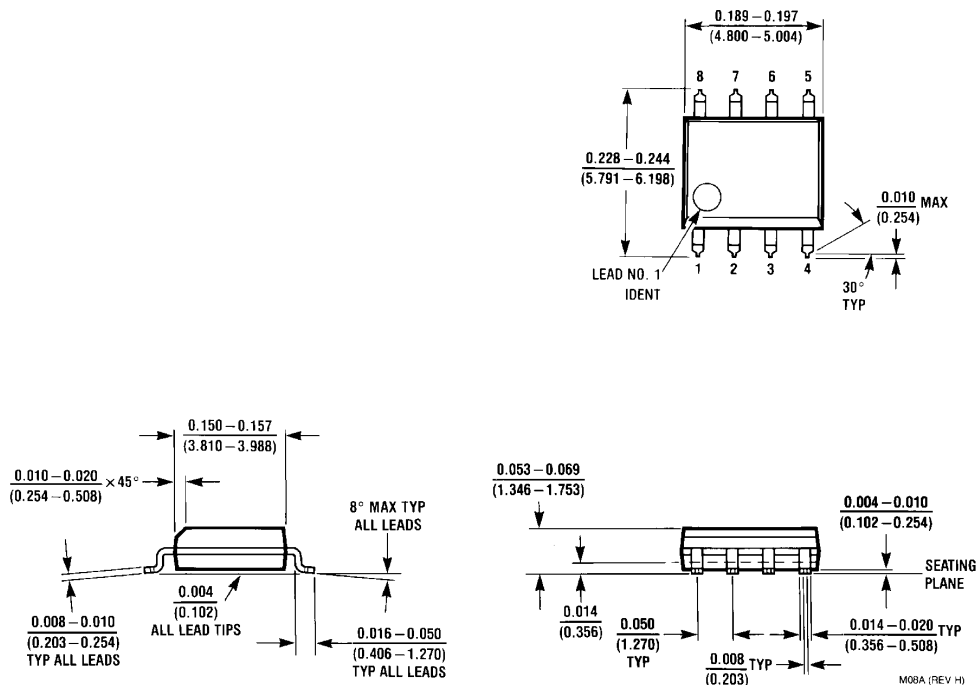

8-Lead (0.150" Wide) Molded Small Outline Package, JEDEC NS Package Number M08A

LIFE SUPPORT POLICY

NATIONAL'S PRODUCTS ARE NOT AUTHORIZED FOR USE AS CRITICAL COMPONENTS IN LIFE SUPPORT DEVICES OR SYSTEMS WITHOUT THE EXPRESS WRITTEN APPROVAL OF THE PRESIDENT OF NATIONAL SEMICONDUCTOR CORPORATION. As used herein:

1. Life support devices or systems are devices or systems which, (a) are intended for surgical implant into the body, or (b) support or sustain life, and whose failure to perform when properly used in accordance with instructions for use provided in the labeling, can be reasonably expected to result in a significant injury to the user.
2. A critical component is any component of a life support device or system whose failure to perform can be reasonably expected to cause the failure of the life support device or system, or to affect its safety or effectiveness.



National Semiconductor Corporation
Americas
Tel: 1-800-272-9959
Fax: 1-800-737-7018
Email: support@nsc.com

National Semiconductor Europe
Fax: +49 (0) 1 80-530 85 86
Email: europe.support@nsc.com
Deutsch Tel: +49 (0) 1 80-530 85 85
English Tel: +49 (0) 1 80-532 78 32
Français Tel: +49 (0) 1 80-532 93 58
Italiano Tel: +49 (0) 1 80-534 16 80

National Semiconductor Asia Pacific Customer Response Group
Tel: 65-2544466
Fax: 65-2504466
Email: sea.support@nsc.com

National Semiconductor Japan Ltd.
Tel: 81-3-5639-7560
Fax: 81-3-5639-7507

www.national.com