

Series PVT322

Microelectronic Power IC
HEXFET® Power MOSFET Photovoltaic Relay
Dual Pole, Normally Open
0-250V, 170mA AC/DC

General Description

The PVT322 Series Photovoltaic Relay is a dual-pole, normally open solid-state relay that can replace electromechanical relays in many applications. It utilizes International Rectifier's HEXFET power MOSFET as the output switch, driven by an integrated circuit photovoltaic generator of novel construction. The output switch is controlled by radiation from a GaAlAs light emitting diode (LED) which is optically isolated from the photovoltaic generator. Series PVT322 Relays are packaged in an 8-pin, molded DIP package with either through-hole or surface mount (gull-wing) terminals. It is available in standard plastic shipping tubes or on tape-and-reel. Please refer to Part Identification information opposite.

Applications

- On/Off Hook switch
- Tip and Ring Line switching
- General switching

Features

- HEXFET Power MOSFET output
- Bounce-free operation
- 4,000 V_{RMS} I/O isolation
- Linear AC/DC operation
- Solid-State Reliability
- UL recognized and BABT certified

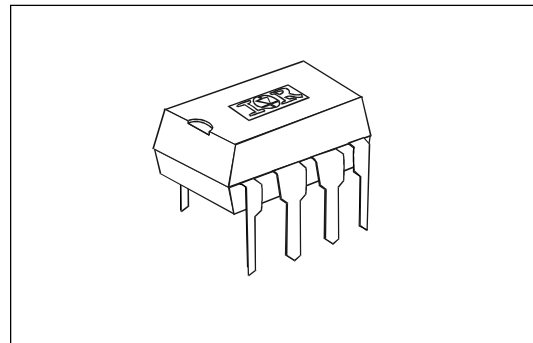

Part Identification

PVT322	thru-hole
PVT322S	SMT
PVT322S-T	SMT, T&R

Series PVT322

International
IR Rectifier

Electrical Specifications (-40°C ≤ T_A ≤ +85°C unless otherwise specified)

INPUT CHARACTERISTICS	Limits	Units
Minimum Control Current (See figure 1)	2.0	mA
Maximum Control Current for Off-State Resistance @T _A =+25°C	0.4	mA
Control Current Range (Caution: current limit input LED, see figure 5)	2.0 to 25	mA
Maximum Reverse Voltage	7.0	V

OUTPUT CHARACTERISTICS	Limits	Units
Operating Voltage Range	0 to ±250	V _(DC or AC peak)
Maximum Load Current @ T _A =+40°C 5mA Control (See figure 1) (single and dual channel operation)	170	mA
Maximum Peak Load Current (10ms maximum duration) (single and dual channel operation)	500	mA
Maximum On-State Resistance @T _A =+25°C For 50mA Pulsed load, 5mA Control (see figure 3)	10	Ω
Maximum Off-State Leakage @T _A =+25°C, ±250V (see figure 4)	1.0	μA
Maximum Turn-On Time @T _A =+25°C (see figure 6) For 50mA, 100 V _{DC} load, 5mA Control	3.0	ms
Maximum Turn-Off Time @T _A =+25°C (see figure 6) For 50mA, 100 V _{DC} load, 5mA Control	0.5	ms
Maximum Output Capacitance @ 50V _{DC}	50	pF

GENERAL CHARACTERISTICS	Limits	Units	
Minimum Dielectric Strength, Input-Output	4000	V _{RMS}	
Minimum Dielectric Strength, Pole-to-Pole	1000	V _{DC}	
Minimum Insulation Resistance, Input-Output, @T _A =+25°C, 50%RH, 100V _{DC}	10 ¹²	Ω	
Maximum Capacitance, Input-Output	1.0	pF	
Maximum Pin Soldering Temperature (10 seconds maximum)	+260	°C	
Ambient Temperature Range:	Operating		-40 to +85
	Storage		-40 to +100

Connection Diagram

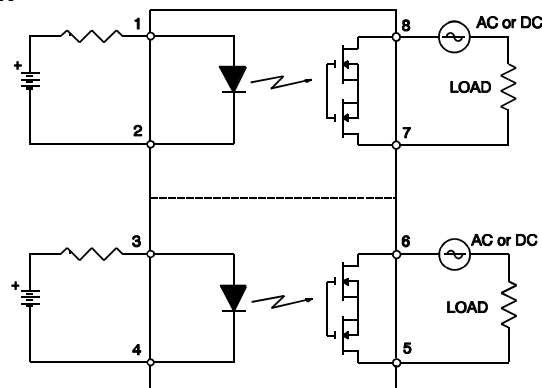

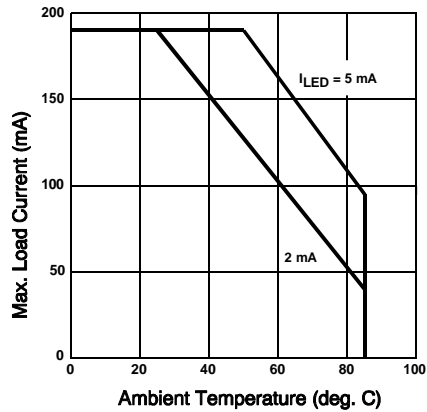

Figure 1. Typical Current Derating Curve

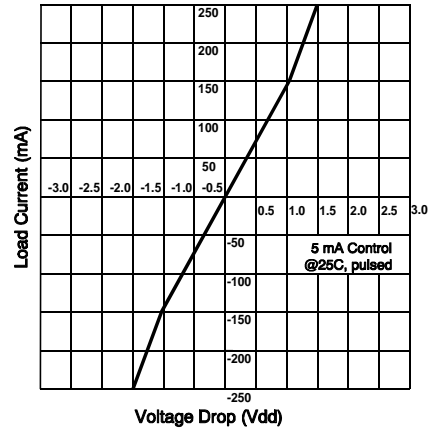

Figure 2. Linearity Characteristics

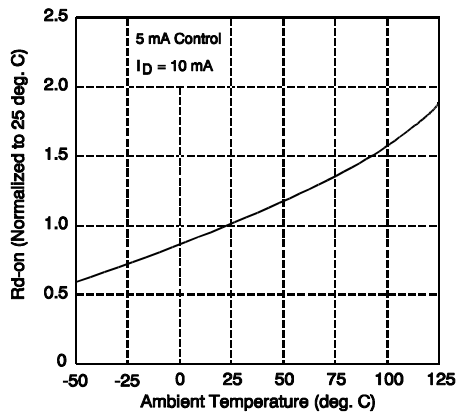

Figure 3. Typical Normalized On-Resistance

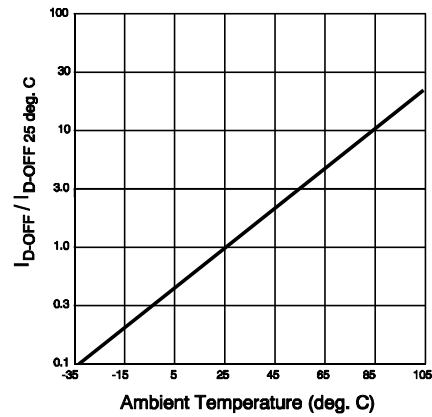

Figure 4. Typical Normalized Off-State Leakage

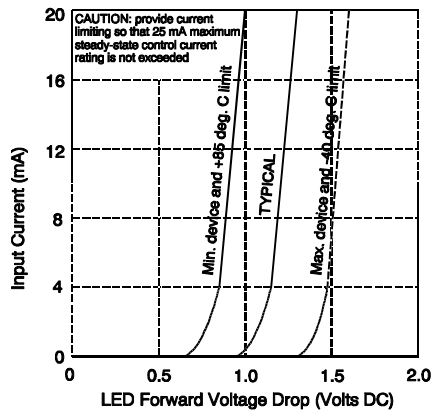

Figure 5. Input Characteristics (Current Controlled)

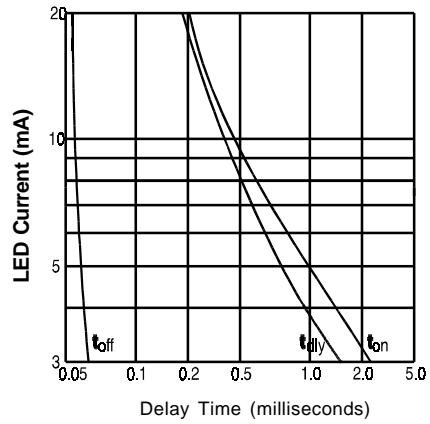

Figure 6. Typical Delay Times

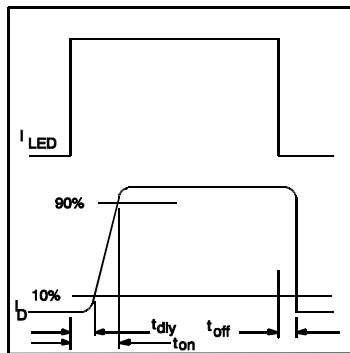

Figure 7. Delay Time Definitions

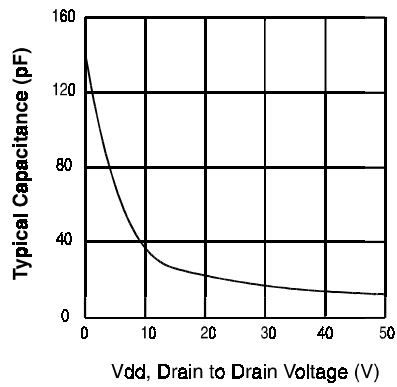
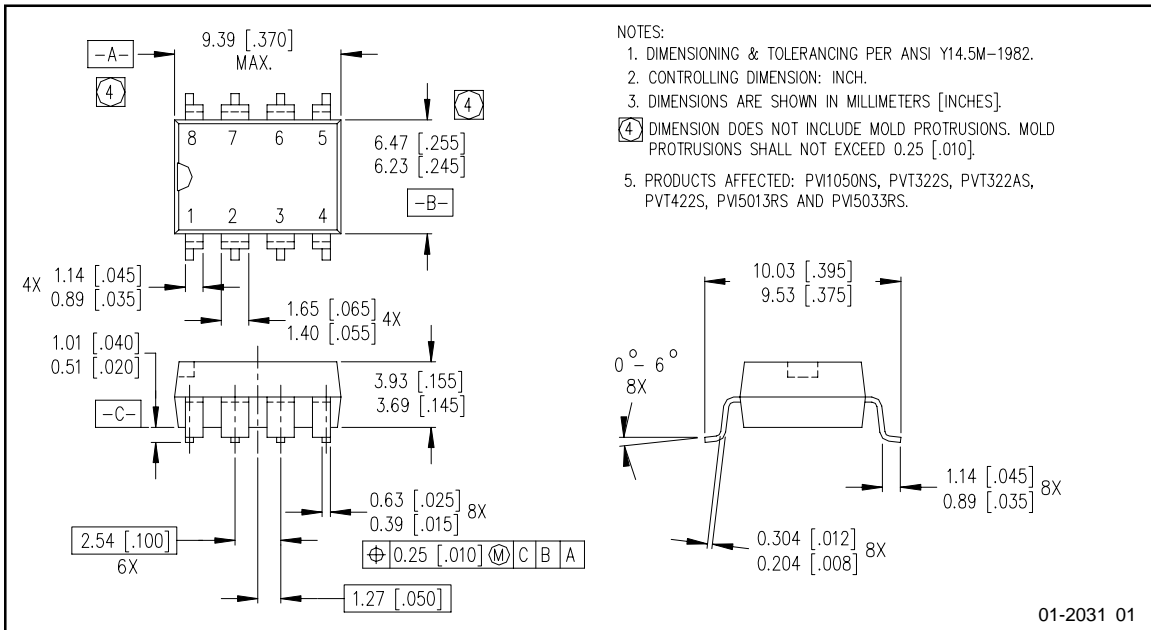
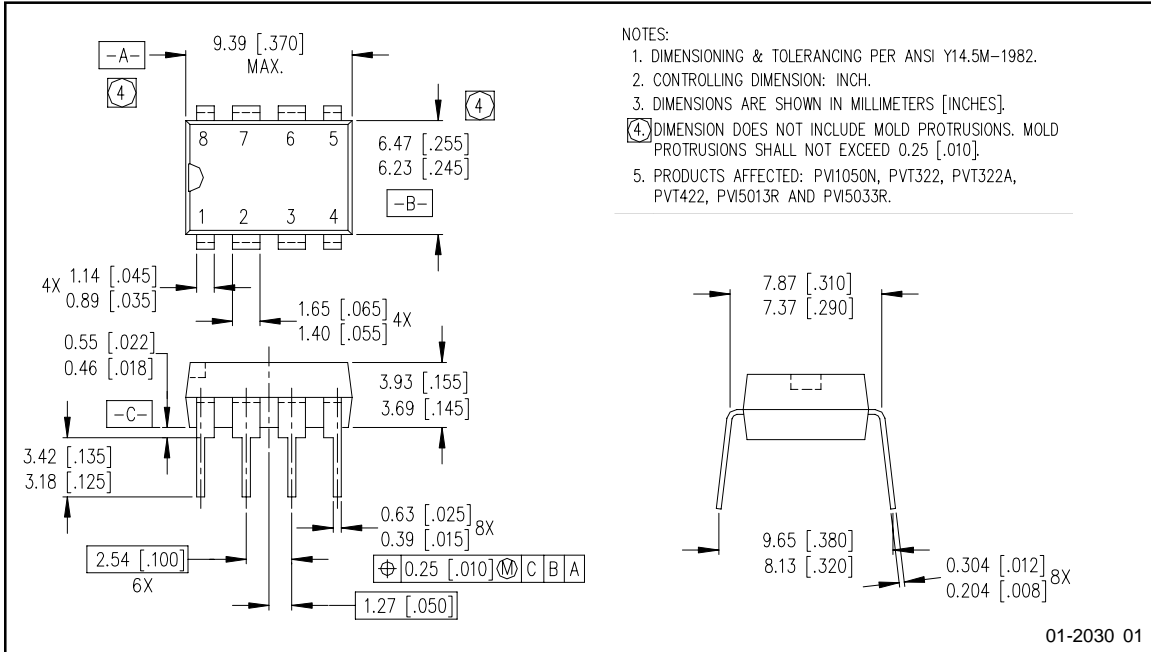

Figure 8. Typical Output Capacitance

Case Outlines



IR WORLD HEADQUARTERS: 233 Kansas St., El Segundo, California 90245 Tel: (310) 252-7105
 Data and specifications subject to change without notice. 5/19/2003