

S202SE1/S202SE2

S216SE1/S216SE2

■ Features

- Comforms to European Safety Standard (EN60950)
(Need of the insulation sheet when mounting external heat sink)
Internal insulation distance : 0.4mm or more
Creepage distance : 5mm or more
Space distance : 4mm or more
- RMS ON-state current
S202SE1 / S202SE2 : 8Arms at $T_c \leq 80^\circ\text{C}$
(with heat sink)
S216SE1 / S216SE2 : 16Arms at $T_c \leq 60^\circ\text{C}$
(with heat sink)
- Isolation voltage between input and output (V_{iso} : 3 000V_{rms})
- Approved by TÜV, No. R9051479
- Recognized by UL, No. E94758
(S202SE1 / S202SE2)
Approved by CSA, No. LR63705
(S202SE1, S202SE2)

■ Applications

- Copiers
- Laser beam printers

■ Line-up

	RMS ON-state current	
	MAX. 8Arms	MAX. 16Arms
No built-in Zero-cross circuit	S202SE1	S216SE1
Built-in Zero-cross circuit	S202SE2	S216SE2

■ Absolute Maximum Ratings

Parameter	Symbol	Rating		Unit
		S202SE1/S202SE2	S216SE1/S216SE2	
Input	Forward current	I_F	50	mA
	Reverse voltage	V_R	6	V
	RMS ON-state current	I_T	*48	A _{rms}
	*1 Peak one cycle surge current	I_{surge}	80	A
Output	Repetitive peak OFF-state voltage	V_{DRM}	600	V
	Non-repetitive peak OFF-state voltage	V_{DSM}	600	V
	Critical rate of rise of ON-state current	dI_T / dt	50	A/ μ s
	Operating frequency	f	45 to 65	Hz
	*2 Isolation voltage	V_{iso}	3,000	V _{rms}
	Operating temperature	T_{opr}	- 25 to + 100	$^\circ\text{C}$
	Storage temperature	T_{stg}	- 30 to + 125	$^\circ\text{C}$
	*3 Soldering temperature	T_{sol}	260	$^\circ\text{C}$

*1 60Hz sine wave, $T_j = 25^\circ\text{C}$ start

*2 AC 60Hz for 1 minute, 40 to 60% RH, Apply voltages between input and output by the dielectric withstand voltage tester with zero-cross circuit.(Input and output shall be shorted respectively).

(Note) When the isolation voltage is necessary at using external heat sink, please use the insulation sheet.

*3 For 10 seconds *4 $T_c \leq 80^\circ\text{C}$ *5 $T_c \leq 60^\circ\text{C}$

SIP Type SSR for Medium Power Control

■ Outline Dimensions

(Unit : mm)

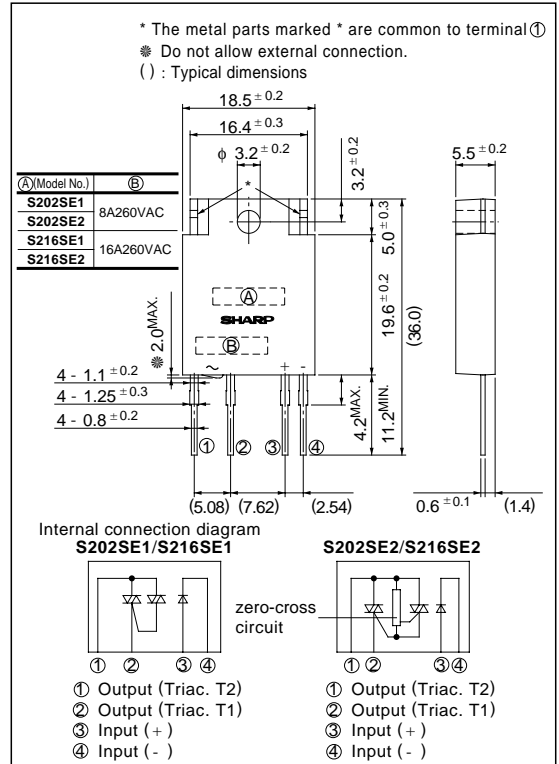

($T_a = 25^\circ\text{C}$)

Electrical Characteristics

(Ta = 25°C)

Parameter		Symbol	Conditions	MIN.	TYP.	MAX.	Unit	
Input	Forward voltage	V _F	I _F = 20mA	-	1.2	1.4	V	
	Reverse current	I _R	V _R = 3V	-	-	10 ⁻⁴	A	
Repetitive peak OFF-state current		I _{DRM}	V _D = V _{DRM}	-	-	10 ⁻⁴	A	
Output	ON-state voltage	V _T	I _T = 2A _{rms}	-	-	1.5	V _{rms}	
			I _T = 16A _{rms}	-	-	1.5		
	Holding current		I _H	-	-	-	50	mA
	Critical rate of rise of OFF-state voltage		dV/dt	V _D = 2/3V _{DRM}	30	-	-	V/μs
	Critical rate of rise of commutating OFF-state voltage		(dV/dt) _c	T _j = 125°C, V _D = 400V *6	5	-	-	V/μs
	Zero-cross voltage	S202SE2/S216SE2	V _{OX}	I _F = 8mA	-	-	35	V
Transfer characteristics	Minimum trigger current	I _{FT}	S202SE1/S216SE1	V _D = 12V, R _L = 30Ω	-	-	8	mA
			S202SE2/S216SE2	V _D = 6V, R _L = 30Ω	-	-	8	
			Isolation resistance		R _{ISO}	DC500V, 40 to 60 % RH	10 ¹⁰	
	Turn-on time	S202SE1/S216SE1	t _{on}	AC60Hz	-	-	1	ms
		S202SE2/S216SE2			-	-	9.3	
	Turn-off time		t _{off}	AC60Hz	-	-	9.3	ms
Thermal resistance (Between junction and case)		R _{th(j-c)}	-	-	4.5	-	°C/W	
				-	3.3	-		
Thermal resistance (Between junction and ambience)		R _{th(j-a)}	-	-	40	-	°C/W	

*6 dI_T/dt = -4.0A/ms (S202SE1/S202SE2)dI_T/dt = -8.0A/ms (S216SE1/S216SE2)

Fig.1-a RMS ON-state Current vs. Ambient Temperature
(S202SE1/S202SE2)

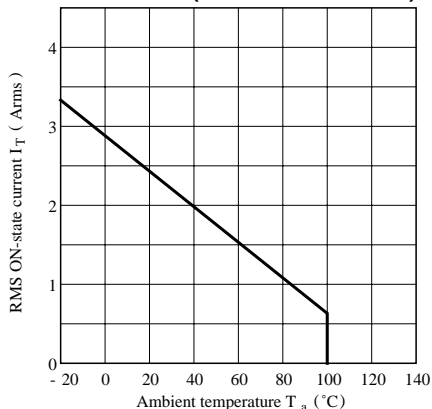

Fig.1-b RMS ON-state Current vs. Ambient Temperature
(S216SE1/S216SE2)

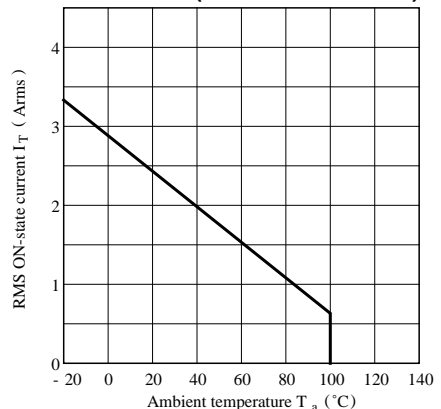

Fig.2-a RMS ON-state Current vs. Case Temperature (S202SE1/ S202SE2)

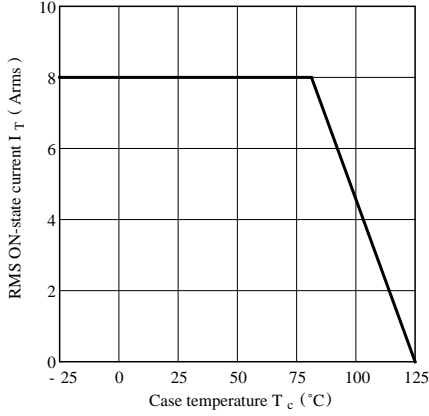

Fig.2-b RMS ON-state Current vs. Case Temperature (S216SE1/ S216SE2)

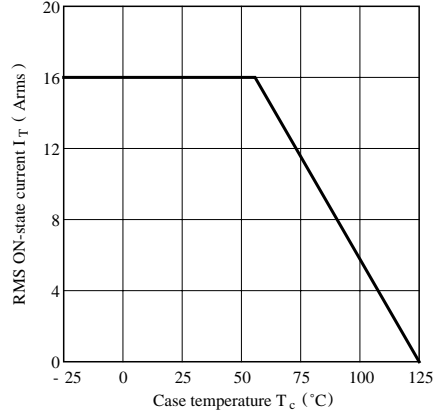

Fig. 3 Forward Current vs. Ambient Temperature

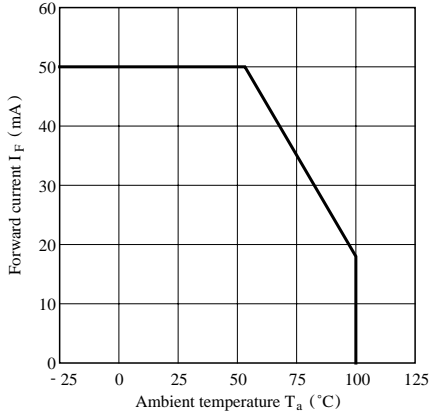

Fig. 4 Forward Current vs. Forward Voltage

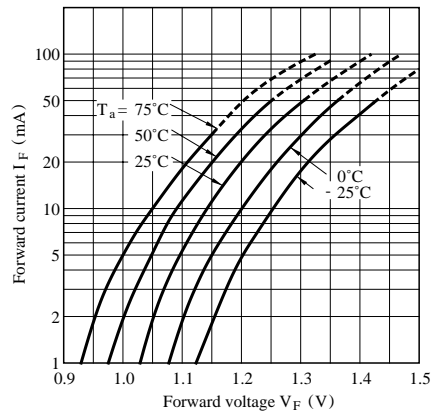

Fig.5-a Surge Current vs. Power-ON Cycle (S202SE1/ S202SE2)

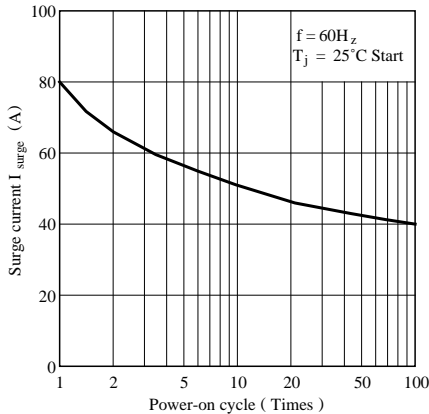

Fig.5-b Surge Current vs. Power-ON Cycle (S216SE1/ S216SE2)

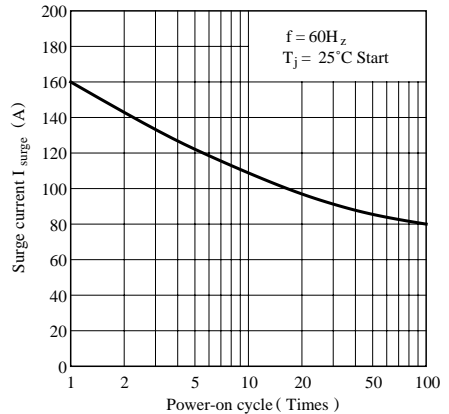

Fig.6-a Maximum ON-State Power Dissipation vs. RMS ON-State Current (S202SE1 / S202SE2)

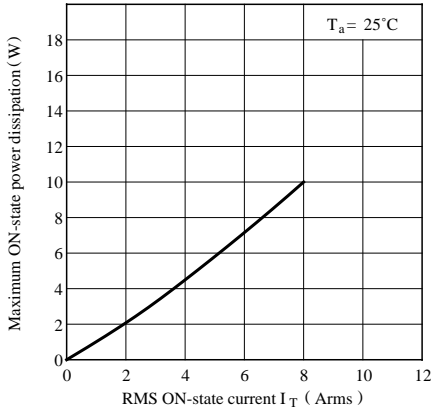

Fig.6-b Maximum ON-State Power Dissipation vs. RMS ON-State Current (S216SE1 / S216SE2)

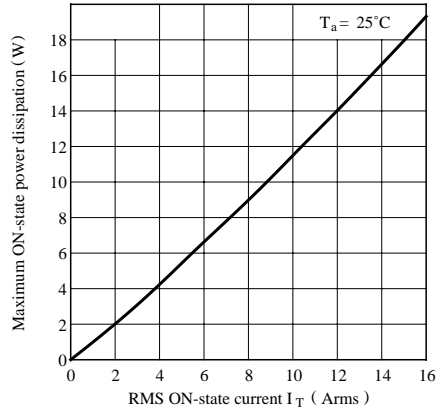

Fig.7-a Minimum Trigger Current vs. Ambient Temperature (Typical Value) (S202SE1 / S216SE1)

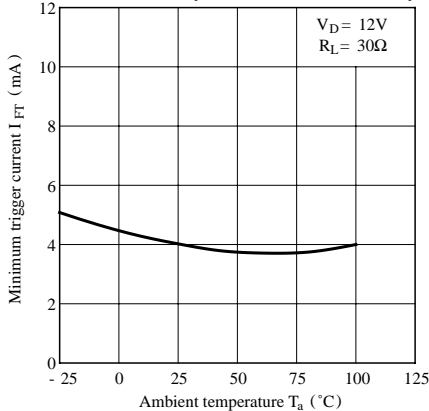

Fig.7-b Minimum Trigger Current vs. Ambient Temperature (Typical Value) (S202SE2 / S216SE2)

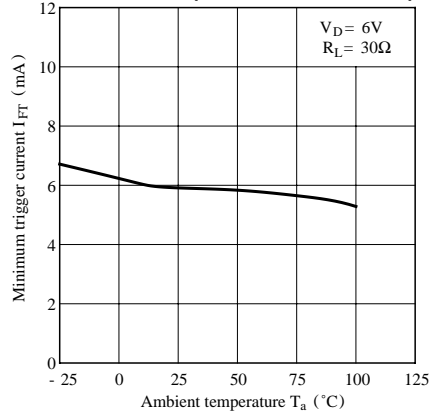

Fig.8-a Repetitive Peak OFF-state Current vs. Ambient Temperature (Typical Value) (S202SE1 / S202SE2)

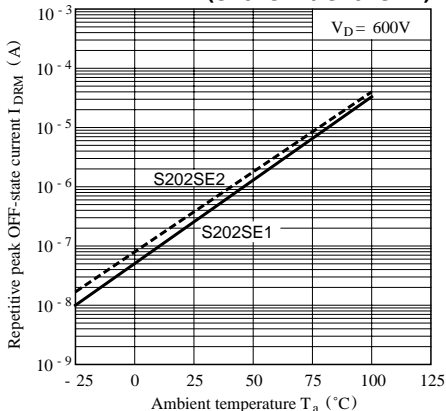

Fig.8-b Repetitive Peak OFF-state Current vs. Ambient Temperature (Typical Value) (S216SE1 / S216SE2)

