

**CONTROL CIRCUIT FOR SWITCH MODE POWER SUPPLIES
USING MOS TRANSISTORS**

- FOLD-BACK CHARACTERISTIC PROVIDES OVERLOAD PROTECTION FOR EXTERNAL DIODES
- BURST OPERATION UNDER SHORT-CIRCUIT AND NO LOAD CONDITIONS
- LOOP ERROR PROTECTION
- SWITCH-OFF IN CASE OF TOO LOW LINE VOLTAGE (under voltage switch-off)
- LINE VOLTAGE COMPENSATION OF OVERLOAD POINT
- SOFT-START FOR SMOOTH START-UP
- CHIP OVER-TEMPERATURE PROTECTION (thermal shutdown)
- ON-CHIP PARASITIC TRANSFORMER OSCILLATION SUPPRESSION CIRCUITRY
- DECREASE OF REGULATED VOLTAGE FOR LOW POWER CONSUMPTION

DESCRIPTION

The IC TDA4605 controls the MOS Power Transistor and performs all necessary regulation and monitoring functions in free running flyback converters. Since good load regulation over a wide load range is attained, this IC is particularly suitable for Consumer as well as Industrial Power Supplies.

Alternative source of the TDA4605 is also available from SIEMENS Semiconductors Consumer Electronics A.G.

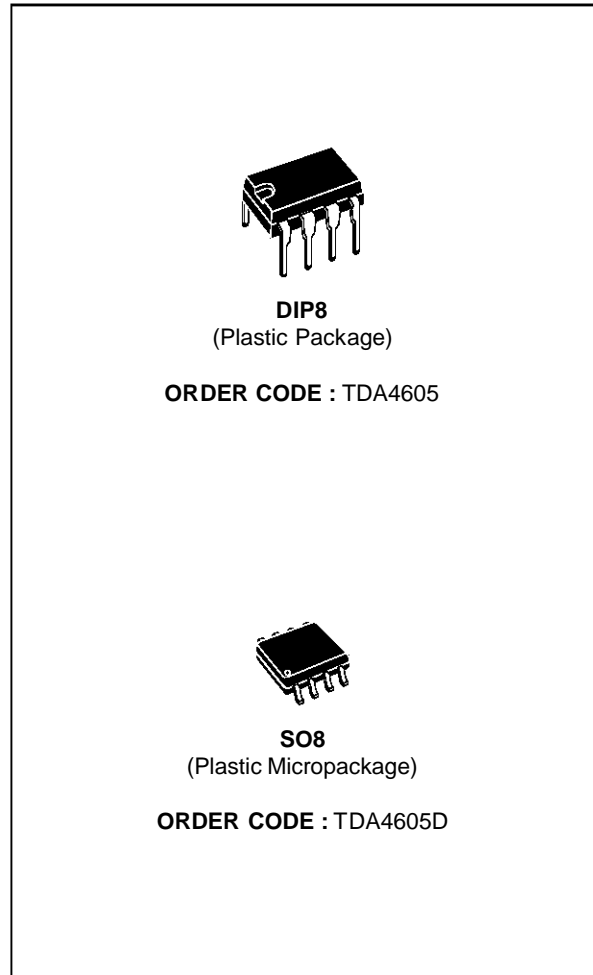

PIN CONNECTIONS

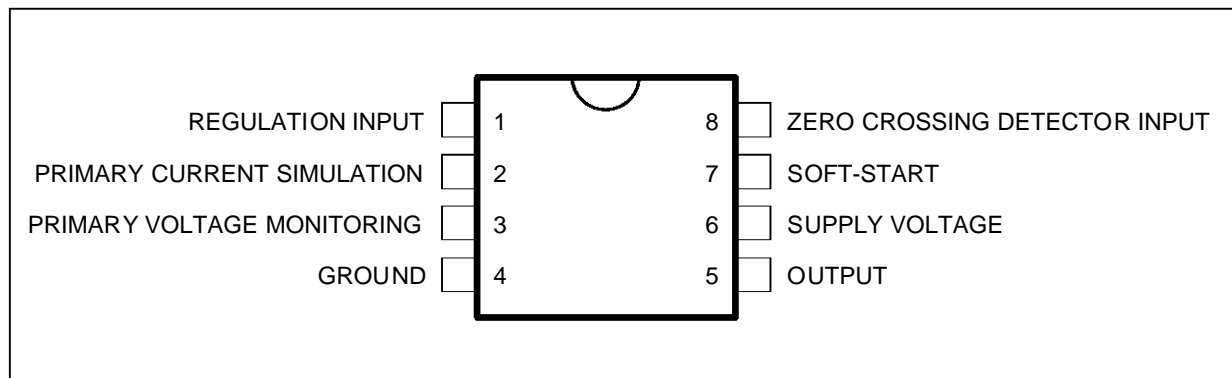

4605-01.EPS

PIN CONFIGURATION

Pin Number	Description
1	Regulating voltage : information input concerning secondary voltage. By comparing the regulating voltage obtained from the regulating winding of the transformer with the internal reference voltage, the output pulse width on Pin 5 is adapted to the load of the secondary side (normal, overload, short circuit, no load)
2	Primary current simulation : information input regarding the primary current. The primary current rise in the primary winding is simulated at Pin 2 as a voltage rise by means of external RC element. When a value is reached that is derived from the regulating voltage at Pin 1, the output pulse at Pin 5 is terminated. The RC element serves to set the maximum power at the overload point.
3	Primary voltage detector : input for primary voltage monitoring. When the line voltage is too low the IC is switched-off by comparing V_3 with an internal reference. Voltage at Pin 3 is used for overload point compensation.
4	Ground
5	Output : push-pull output for charge and discharge of the gate capacitance of the power MOS transistor.
6	Supply voltage : Supply voltage input. From it are derived a stable internal reference voltage (V_{REF}) and the switching threshold V_{6A} , V_{6E} , V_{6max} and V_{6min} for the supply voltage detector. if $V_6 > V_{6E}$ the V_{REF} is switched on and switched off when $V_6 < V_{6A}$. In addition the logic is only enable for $V_{6min} < V_6 < V_{6max}$.
7	Soft-start : input for soft-start and integration network. Start-up will begin with short pulses by connecting a capacitor between Pin 7 to ground. This capacitor together with a resistor connected between Pin 7 and error amplifier output also as acts an integrator network for regulation.
8	Zero detector : Input for the oscillator feedback. After starting oscillator, every zero transit of the feedback voltage (falling edge) triggers an output pulse at Pin 5. The trigger threshold is at typically - 50mV

4605-01.TBL

BLOCK DIAGRAM

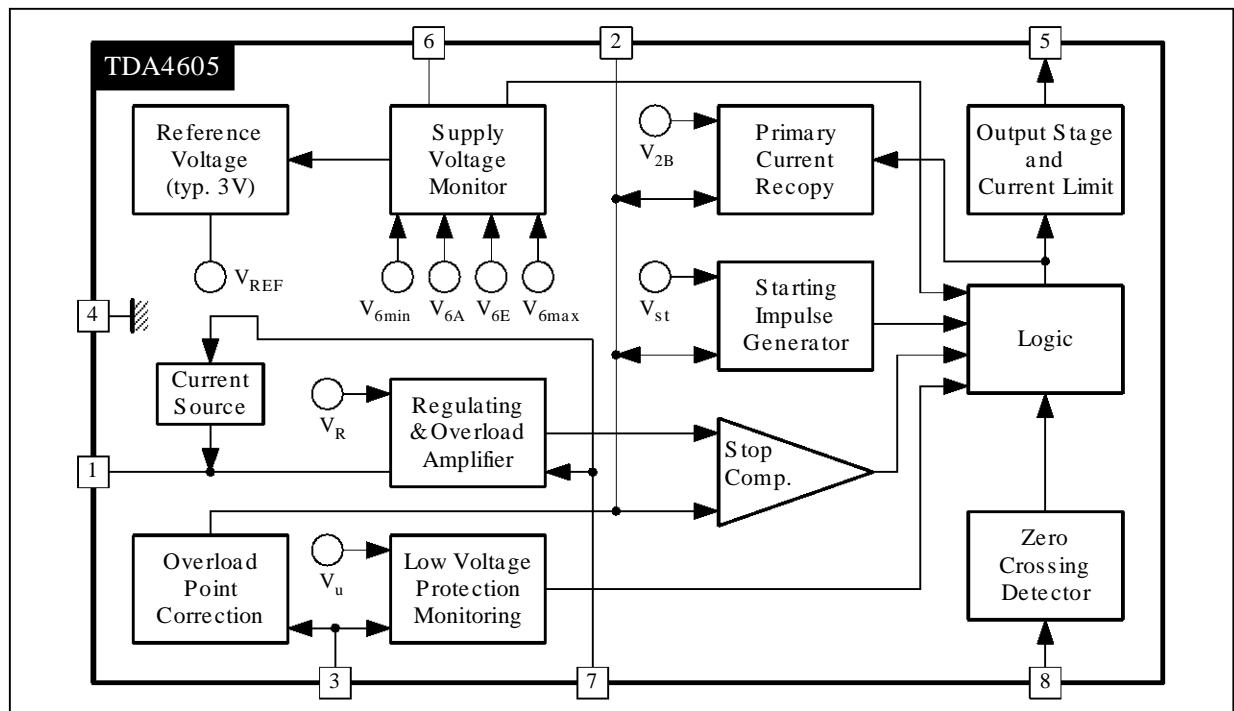

4605-02.EPS

ABSOLUTE MAXIMUM RATINGS

Symbol	Parameter	Pin	Value	Unit	
V ₁	Supply Voltage	1	-0.3, +3	V	
V ₂		2	-0.3	V	
V ₃		3	-0.3	V	
V ₄		4	-0.3	V	
V ₆		6	-0.3, +20	V	
V ₇		7	-0.3	V	
I ₁		Supply Current	1	3	mA
I ₂	2		3	mA	
I ₃	3		3	mA	
I ₄	$t_p \leq 50\mu s, V \leq 0.1$		4	-1.5	A
I ₅	$t_p \leq 50\mu s, V \leq 0.1$		5	-0.5, +1.5	A
I ₆	$t_p \leq 50\mu s, V \leq 0.1$		6	0.5	A
I ₇	7		3	mA	
I ₈	8		-3, +3	mA	
T _j	Junction Temperature (autom. thermal disjunction)		+125	°C	
T _{stg}	Storage Temperature		-40, +125	°C	

4605-02.TBL

THERMAL DATA

Symbol	Parameter	Value	Unit
R _{th(j-a)}	Junction-ambient Thermal Resistance	80	°C/W
R _{th(j-c)}	Junction-case Thermal Resistance	45	°C/W
T _{amb}	Ambient Temperature	-20, +85	°C

4605-03.TBL

ELECTRICAL CHARACTERISTICS (V_{CC} = 10V, T_{amb} = 25°C, unless otherwise specified)

Symbol	Parameter	Test Conditions	Min.	Typ.	Max.	Unit
--------	-----------	-----------------	------	------	------	------

START-UP HYSTERESIS

I _{6E0}	Start-up Current Drain	V ₆ = V _{6E}		0.6	0.8	mA
V _{6E}	Switch-on Voltage		11	12	13	V
V _{6A}	Switch-off Voltage		4.5	5	5.5	V
I _{6E1}	Switch-on Current	V ₆ = V _{6E}		11		mA
I _{6A1}	Switch-off Current	V ₆ = V _{6A}		10		mA

VOLTAGE CLAMP (V₆ = 10V, IC Switched off)

V _{2(Max.)}	At Pin 2 (V ₆ < V _{6E})	I ₂ = 1mA	5.6	6.6	9	V
V _{3(Max.)}	At Pin 3 (V ₆ < V _{6E})	I ₃ = 1mA	5.6	6.6	9	V

CONTROL RANGE

V _{1R}	Control Input Voltage		400	410	420	mV
-V _R	Voltage Gain of the Control Circuit in the Control Range	V _R = d(V _{2S} - V _{2B})/dV ₁ f = 1kHz		43		dB

PRIMARY CURRENT SIMULATION VOLTAGE

V _{2B}	Basic Value		0.955	1.00	1.03	V
-----------------	-------------	--	-------	------	------	---

OVERLOAD RANGE AND SHORT CIRCUIT OPERATION

V ₂₀	Peak Value in the Range of Secondary Overload	V ₁ = V _{1R} - 10mV	2.8	2.95	3.1	V
DV ₂	Maximum Ramp Amplitude	V ₂₀ - V _{2B}	1.82	1.95	2.08	V
V _{2S}	Peak Value in the Range of Secondary Short Circuit Operation	V ₁ = 0	2.3	2.5	2.7	V

FOLDBACK POINT CORRECTION

-I ₂	Foldback Point Correction Current	V ₃ = 3.7V	300	500	650	μA
-----------------	-----------------------------------	-----------------------	-----	-----	-----	----

4605-04.TBL

ELECTRICAL CHARACTERISTICS ($V_{CC} = 10V, T_{amb} = 25^{\circ}C$, unless otherwise specified) (continued)

Symbol	Parameter	Test Conditions	Min.	Typ.	Max.	Unit
--------	-----------	-----------------	------	------	------	------

GENERALLY VALID DATA ($V_6 = 10V$)
 VOLTAGE OF THE ZERO Transition DETECTOR

V_{8P}	Positive Clamping Voltage	$I_8 = 1mA$		0.75		V
V_{8N}	Negative Clamping Voltage	$I_8 = -1mA$		-0.2		V
V_{8S}	Threshold Value		40	50		mV
TUL	Suppression of Transformer Ringing		3	3.8	4.5	μs
$-I_8$	Input Current	$V_8 = 0$	0		4	μV

PUSH-PULL OUTPUT STAGE
 SATURATION VOLTAGES

V_{SatU}	Pin 5 Sourcing	$I_5 = -0.1A$		1.5	2.0	V
V_{SatU}	Pin 5 Sinking	$I_5 = +0.1A$		1.0	1.2	V
V_{SatU}	Pin 5 Sinking	$I_5 = +0.5A$		1.4	1.8	V

OUTPUT SLOW RATE

$+dV_5/dt$	Rising Edge			70		$V/\mu s$
$-dV_5/dt$	Falling Edge			100		$V/\mu s$

REDUCTION OF CONTROL VOLTAGE

$-I_1$	Current to reduce the Control Voltage	$V_7 = 1V$		50		μA
--------	---------------------------------------	------------	--	----	--	---------

PROTECTION CIRCUIT

$V_{6(Min.)}$	Undervoltage Protection for V_6 : Voltage at Pin 5 = $V_{5(Min.)}$ if $V_6 < V_{6(Min.)}$		7.0	7.25	7.5	V
$V_{6(Max.)}$	Overvoltage Protection for V_6 : Voltage at Pin 5 = $V_{5(Min.)}$ if $V_6 > V_{6(Max.)}$		15	16	16.5	V
V_{3A}	Undervoltage Protection for V_{AC} : Voltage at Pin 5 = $V_{5(Min.)}$ if $V_3 < V_{3A}$	$V_2 = 0V$	970	1005	1040	mV
Oj	Over Temperature : at the given chip temperature the IC will switch V_5 to $V_{5(Min.)}$			150		$^{\circ}C$
V_{3Sat}	Voltage at Pin 3 if one of the protection functions was triggered ; (V_3 will be clamped until $V_6 < V_{6A}$)	$I_3 = 750\mu A$		0.4	0.8	V
I_6	Current Drain during Burst Operation	$V_3 = V_2 = 0V$		8		mA

4605-05.TBL

FUNCTIONAL DESCRIPTION

In free running fly-back converters, the TDA4605 assumes control of a MOS power transistor and all necessary regulation and monitoring functions.

The serial circuit of power transistor and primary winding of the flyback transformer is connected to the input voltage. During the switch-on period of the transistor, energy is stored in the transformer and during the switch-off period it is fed to the load via the secondary winding. By varying the switch-on time of the power transistor, the IC controls each portion of energy transferred to the secondary side such that the output voltage remains nearly independent of load variations.

The required control information is taken from the input voltage during the switch-on period and from a regulation winding during the switch-off period. A new cycle begins as soon as the energy stored in the transformer has been totally delivered to the

secondary side.

In different load ranges, the SMPS will behave as follows :

- **No-Load Operation** : The power supply unit oscillates in non continuous mode at a typical frequency of 20 to 40kHz. Depending upon the transformer winding and the regulated voltage divider, the output voltage can be slightly above the nominal value.
- **Normal Operation** : Starting from typ. 200kHz, the switching frequency falls with increasing load and decreasing AC voltage. The duty cycle depends primarily on the AC voltage. The output voltage is only slightly load-dependent.
- **OverloadPoint** : Maximum output power is available at this point of the output characteristics
- **Overload** : The energy transferred per operation cycle is limited at the top. Therefore, the output voltage will fall with secondary overloading.

PACKAGE MECHANICAL DATA

8 PINS - PLASTIC DIP

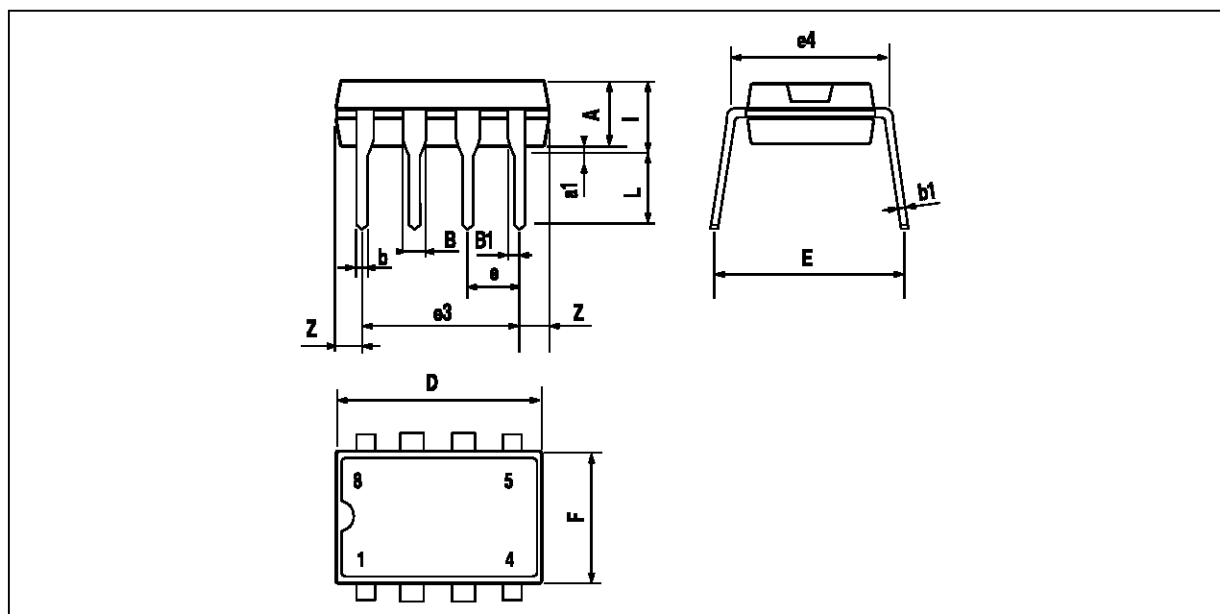

PM-DIP8.EPS

Dimensions	Millimeters			Inches		
	Min.	Typ.	Max.	Min.	Typ.	Max.
A		3.32			0.131	
a1	0.51			0.020		
B	1.15		1.65	0.045		0.065
b	0.356		0.55	0.014		0.022
b1	0.204		0.304	0.008		0.012
D			10.92			0.430
E	7.95		9.75	0.313		0.384
e		2.54			0.100	
e3		7.62			0.300	
e4		7.62			0.300	
F			6.6			0.260
l			5.08			0.200
L	3.18		3.81	0.125		0.150
Z			1.52			0.060

DIP8.TBL

PACKAGE MECHANICAL DATA
 8 PINS - PLASTIC MICROPACKAGE (SO)

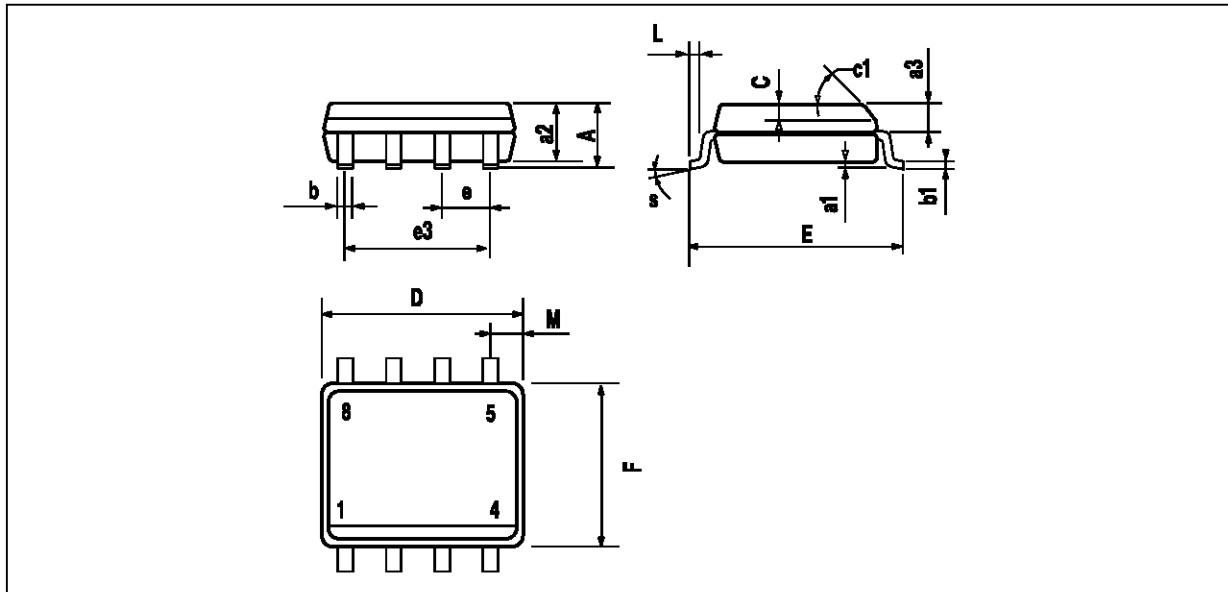

PM-S05LEPS

Dimensions	Millimeters			Inches		
	Min.	Typ.	Max.	Min.	Typ.	Max.
A			1.75			0.069
a1	0.1		0.25	0.004		0.010
a2			1.65			0.065
a3	0.65		0.85	0.026		0.033
b	0.35		0.48	0.014		0.019
b1	0.19		0.25	0.007		0.010
C	0.25		0.5	0.010		0.020
c1	45° (Typ.)					
D	4.8		5.0	0.189		0.197
E	5.8		6.2	0.228		0.244
e		1.27			0.050	
e3		3.81			0.150	
F	3.8		4.0	0.15		0.157
L	0.4		1.27	0.016		0.050
M			0.6			0.024
S	8° (Max.)					

SC8.TBL

Information furnished is believed to be accurate and reliable. However, SGS-THOMSON Microelectronics assumes no responsibility for the consequences of use of such information nor for any infringement of patents or other rights of third parties which may result from its use. No licence is granted by implication or otherwise under any patent or patent rights of SGS-THOMSON Microelectronics. Specifications mentioned in this publication are subject to change without notice. This publication supersedes and replaces all information previously supplied. SGS-THOMSON Microelectronics products are not authorized for use as critical components in life support devices or systems without express written approval of SGS-THOMSON Microelectronics.

© 1996 SGS-THOMSON Microelectronics - All Rights Reserved

Purchase of I²C Components of SGS-THOMSON Microelectronics, conveys a license under the Philips I²C Patent. Rights to use these components in a I²C system, is granted provided that the system conforms to the I²C Standard Specifications as defined by Philips.

SGS-THOMSON Microelectronics GROUP OF COMPANIES

Australia - Brazil - China - France - Germany - Hong Kong - Italy - Japan - Korea - Malaysia - Malta - Morocco
 The Netherlands - Singapore - Spain - Sweden - Switzerland - Taiwan - Thailand - United Kingdom - U.S.A.