

$V_{RSM}$	$V_{RRM}$	$(dv/dt)_{cr}$	$I_{TRMS}$ (maximum value for continuous operation)		
	$V_{DRM}$		40 A		
V	V	V/ $\mu$ s	$I_{TAV}$ (sin. 180; $T_{case} = 60\text{ }^\circ\text{C}$ )		
			25 A		
700	600	500	SKKT 19/06 D	SKKT 20/06 D	–
900	800	500	SKKT 19/08 D	SKKT 20/08 D	SKKT 20B08 D
1300	1200	1000	SKKT 19/12 E	SKKT 20/12 E	SKKT 20B12 E
1500	1400	1000	SKKT 19/14 E	SKKT 20/14 E	SKKT 20B14 E
1700	1600	1000	SKKT 19/16 E	SKKT 20/16 E	SKKT 20B16 E

## SEMIPACK® 1 Thyristor Modules

**SKKT 19**  
**SKKT 20**  
**SKKT 20B**

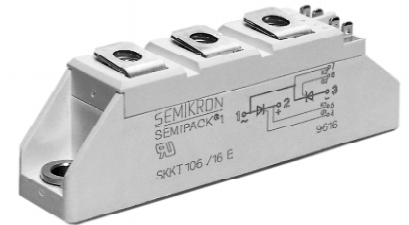

Symbol	Conditions	SKKT 19	SKKT 20 SKKT 20B	Units
$I_{TAV}$	sin. 180; $T_{case} = 60\text{ }^\circ\text{C}$	25		A
	$T_{case} = 85\text{ }^\circ\text{C}$	18		A
$I_D$	B2/B6   $T_{amb} = 45\text{ }^\circ\text{C}$ ; P 3/180	31 / 38		A
	$T_{amb} = 35\text{ }^\circ\text{C}$ ; P 3/180 F	46 / 60		A
$I_{RMS}$	W1/W3   $T_{amb} = 45\text{ }^\circ\text{C}$ ; P 3/180	42 / 3 x 30		A
$I_{TSM}$	$T_{vj} = 25\text{ }^\circ\text{C}$ ; 10 ms	320		A
	$T_{vj} = 125\text{ }^\circ\text{C}$ ; 10 ms	280		A
$i^2t$	$T_{vj} = 25\text{ }^\circ\text{C}$ ; 8,3 ... 10 ms	510		A <sup>2</sup> s
	$T_{vj} = 125\text{ }^\circ\text{C}$ ; 8,3 ... 10 ms	390		A <sup>2</sup> s
$t_{gd}$	$T_{vj} = 25\text{ }^\circ\text{C}$ ; $I_G = 1\text{ A}$ $di_G/dt = 1\text{ A}/\mu\text{s}$	1		$\mu\text{s}$
$t_{gr}$	$V_D = 0,67 \cdot V_{DRM}$	1		$\mu\text{s}$
$(di/dt)_{cr}$	$T_{vj} = 125\text{ }^\circ\text{C}$	150		A/ $\mu\text{s}$
$t_q$	$T_{vj} = 125\text{ }^\circ\text{C}$	typ. 80		$\mu\text{s}$
$I_H$	$T_{vj} = 25\text{ }^\circ\text{C}$ ; typ./max.	100 / 200		mA
$I_L$	$T_{vj} = 25\text{ }^\circ\text{C}$ ; $R_G = 33\ \Omega$ ; typ./max.	250 / 400		mA
$V_T$	$T_{vj} = 25\text{ }^\circ\text{C}$ ; $I_T = 75\text{ A}$	max. 2,3		V
$V_{T(TO)}$	$T_{vj} = 125\text{ }^\circ\text{C}$	1,0		V
$r_T$	$T_{vj} = 125\text{ }^\circ\text{C}$	16		m $\Omega$
$I_{DD}$ ; $I_{RD}$	$T_{vj} = 125\text{ }^\circ\text{C}$ ; $V_{RD} = V_{RRM}$ $V_{DD} = V_{DRM}$	max. 10		mA
$V_{GT}$	$T_{vj} = 25\text{ }^\circ\text{C}$ ; d.c.	3		V
$I_{GT}$	$T_{vj} = 25\text{ }^\circ\text{C}$ ; d.c.	150		mA
$V_{GD}$	$T_{vj} = 125\text{ }^\circ\text{C}$ ; d.c.	0,25		V
$I_{GD}$	$T_{vj} = 125\text{ }^\circ\text{C}$ ; d.c.	5		mA
$R_{thjc}$	cont. } per thyristor / sin. 180 } per module rec. 120 }	1,2 / 0,6		$^\circ\text{C}/\text{W}$
$R_{thch}$		1,3 / 0,65		$^\circ\text{C}/\text{W}$
$T_{vj}$		1,35 / 0,68		$^\circ\text{C}/\text{W}$
$T_{stg}$		0,2 / 0,1		$^\circ\text{C}/\text{W}$
$V_{isol}$		– 40 ... + 125		$^\circ\text{C}$
$M_1$		– 40 ... + 125		$^\circ\text{C}$
$M_2$	a. c. 50 Hz; r.m.s.; 1 s/1 min to heatsink } SI (US) units to terminals }	3600 / 3000		V~
$a$		5 (44 lb. in.) $\pm 15\%$ <sup>1)</sup>		Nm
$w$		3 (26 lb. in.) $\pm 15\%$		Nm
		5 · 9,81		m/s <sup>2</sup>
		95		g
Case	→ page B 1 – 95	SKKT 19: A 5		
		SKKT 20: A 46		
		SKKT 20B: A 48		

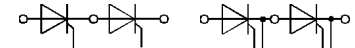

**SKKT 19**

**SKKT 20**  
**SKKT 20B**

### Features

- Heat transfer through aluminium oxide ceramic isolated metal baseplate
- Hard soldered joints for high reliability
- UL recognized, file no. E 63 532

### Typical Applications

- DC motor control (e.g. for machine tools)
- AC motor soft starters
- Temperature control (e.g. for ovens, chemical processes)
- Professional light dimming (studios, theaters)

<sup>1)</sup> See the assembly instructions

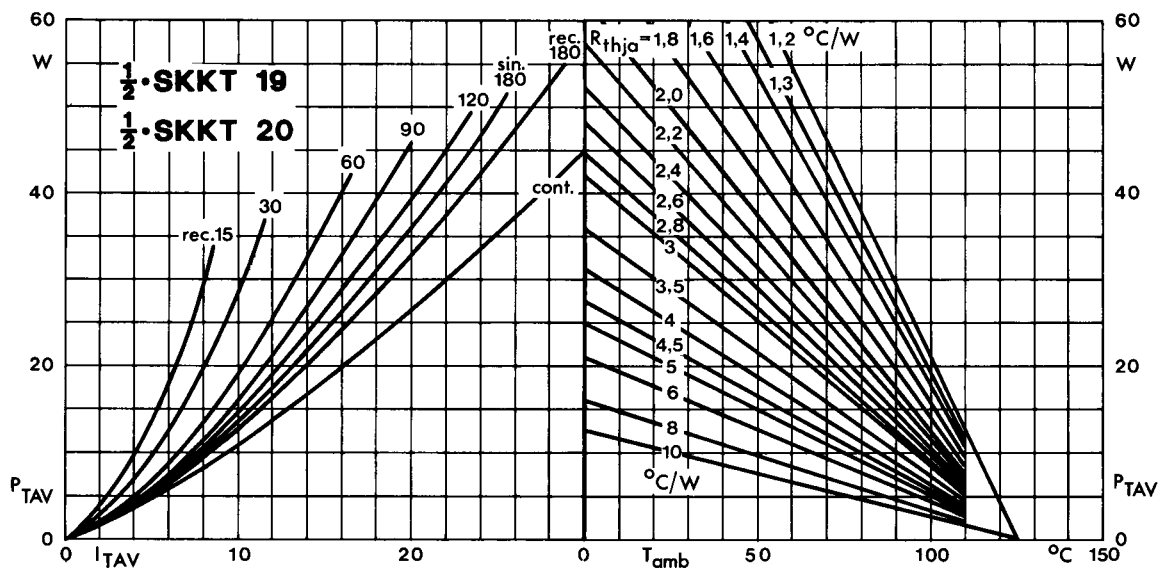

Fig. 1 Power dissipation per thyristor vs. on-state current and ambient temperature

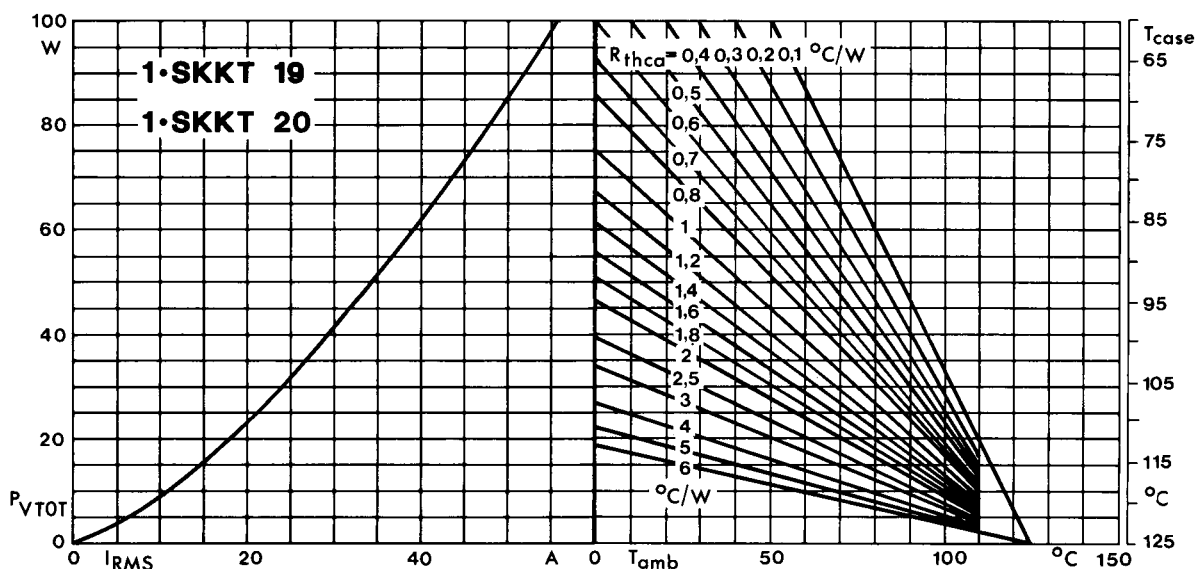

Fig. 2 Power dissipation per module vs. rms current and case temperature

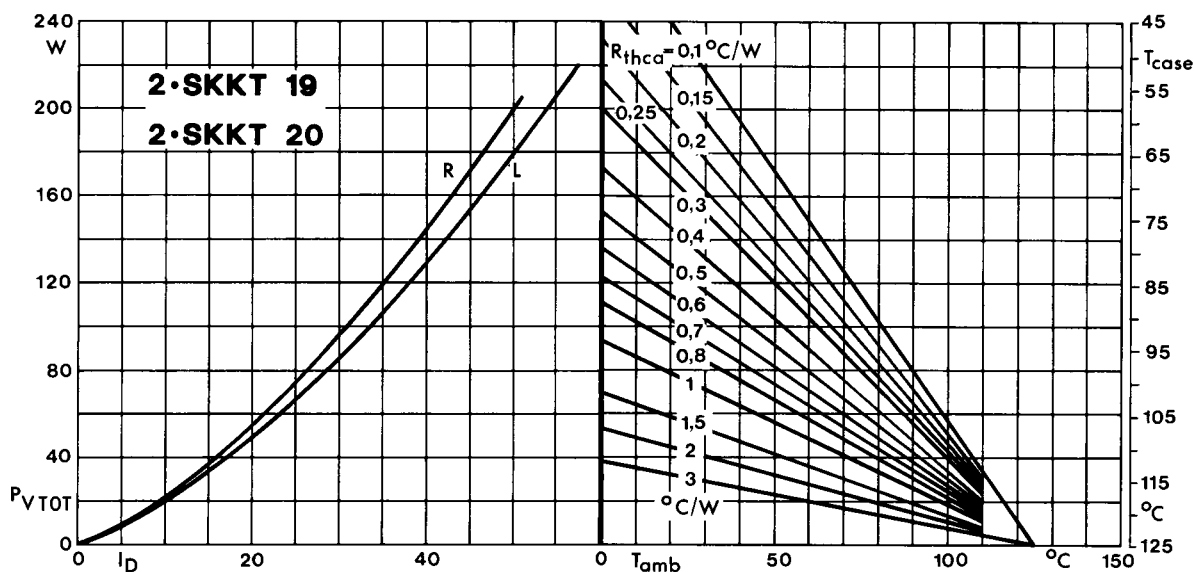

Fig. 3 Power dissipation of two modules vs. direct current and case temperature

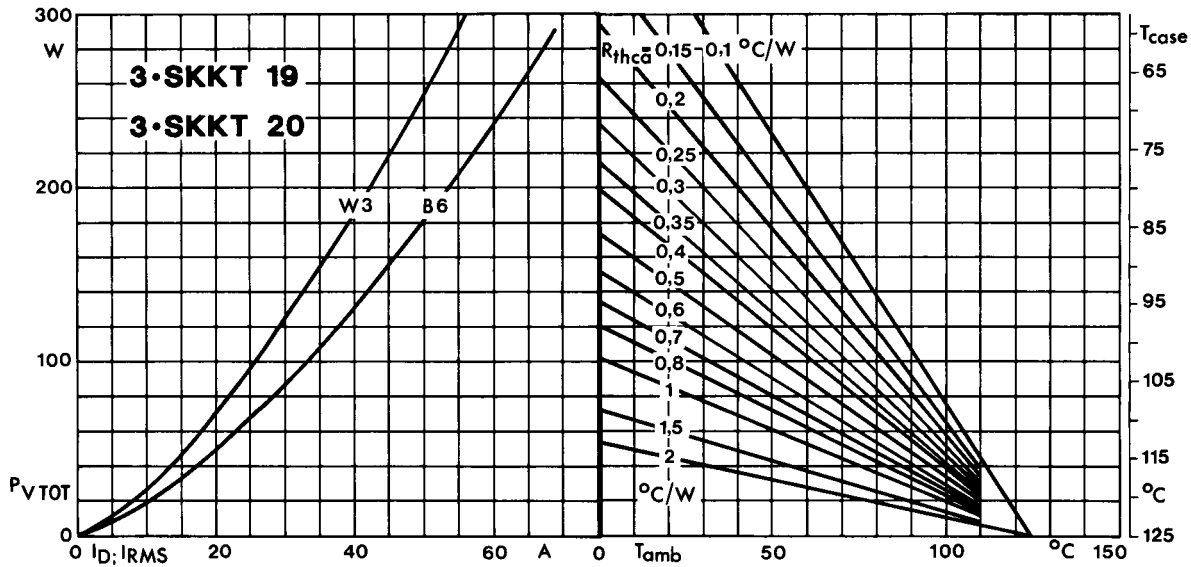

Fig. 4 Power dissipation of three modules vs. direct and rms current and case temperature

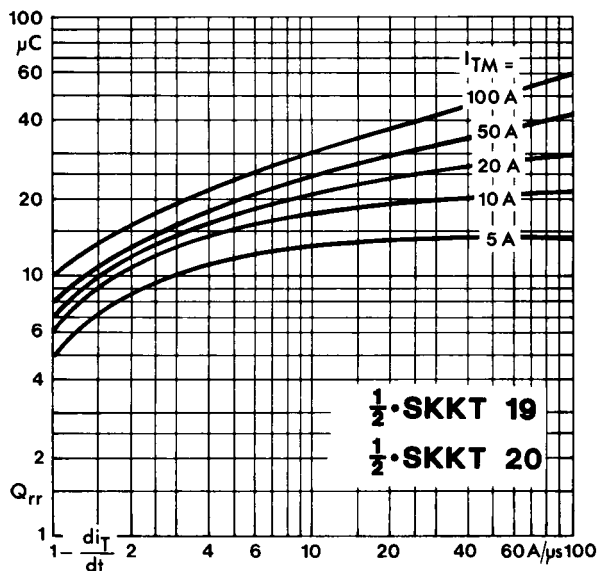

Fig. 5 Recovered charge vs. current decrease

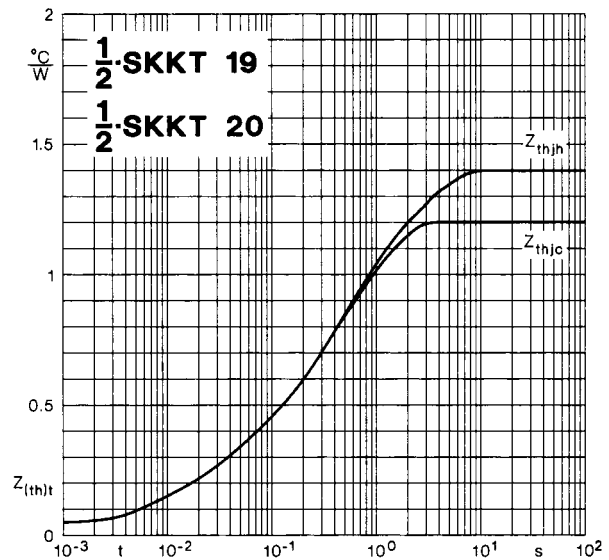

Fig. 6 Transient thermal impedance vs. time

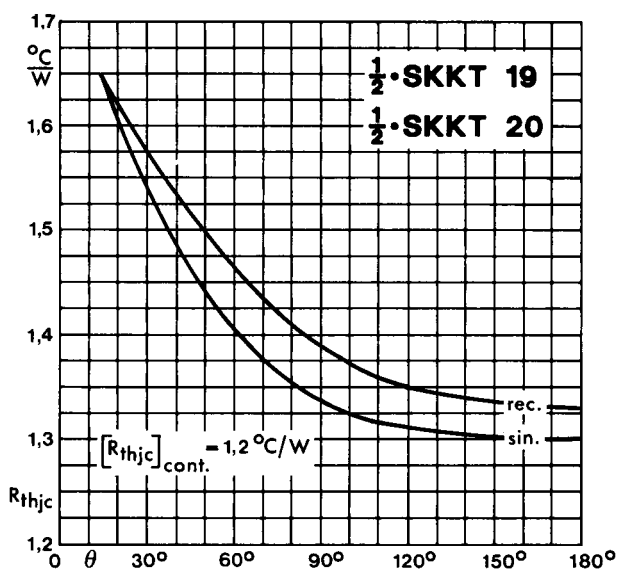

Fig. 7 Thermal resistance vs. conduction angle

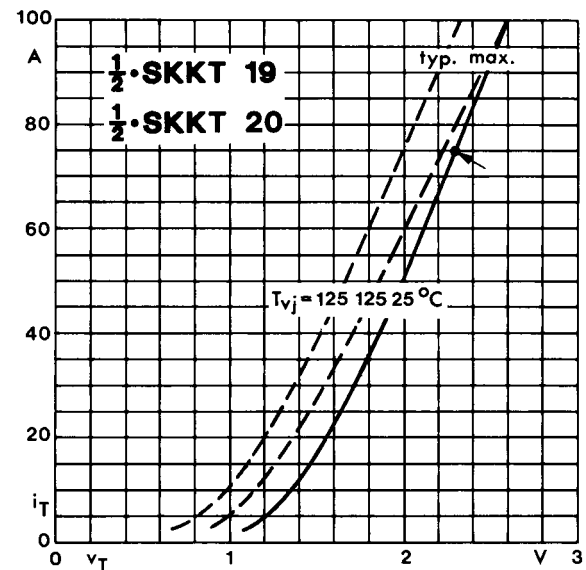

Fig. 8 On-state characteristics

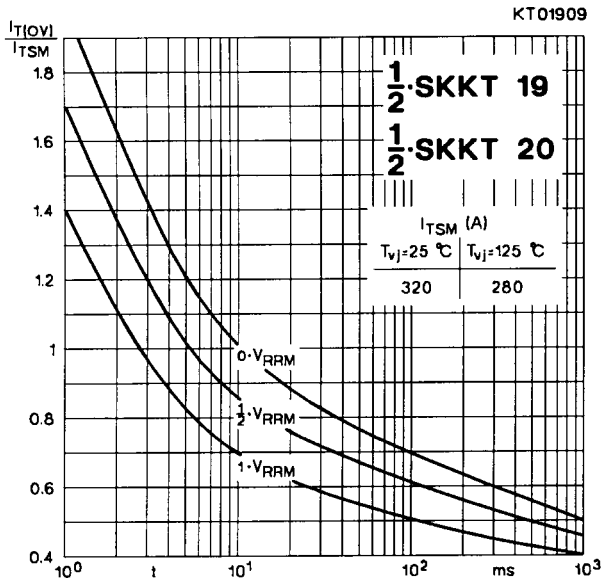

Fig. 9 Surge overload current vs. time

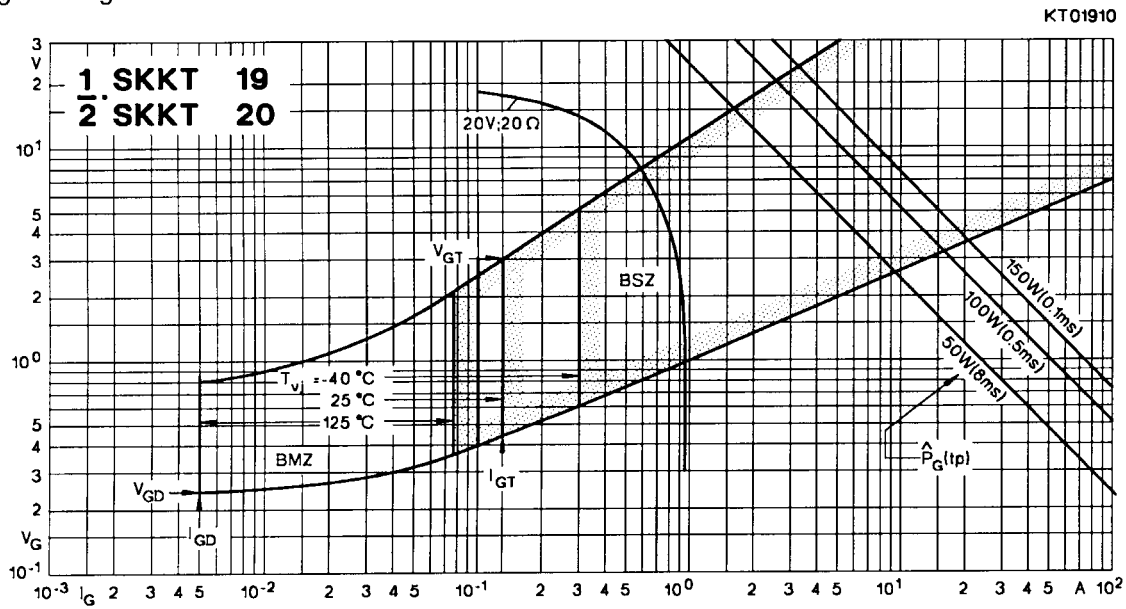

Fig. 10 Gate trigger characteristics

## SKKT 19 ... 105

Case A 5

IEC 192-2: A 77 A

JEDEC: TO-240 AA

SEMIPACK® 1

UL recognized, file no. E 63 532



Dimensions in mm

## SKKT 20/ ... 106/

Case A 46

IEC 192-2: A 77 A

JEDEC: TO-240 AA

SEMIPACK® 1

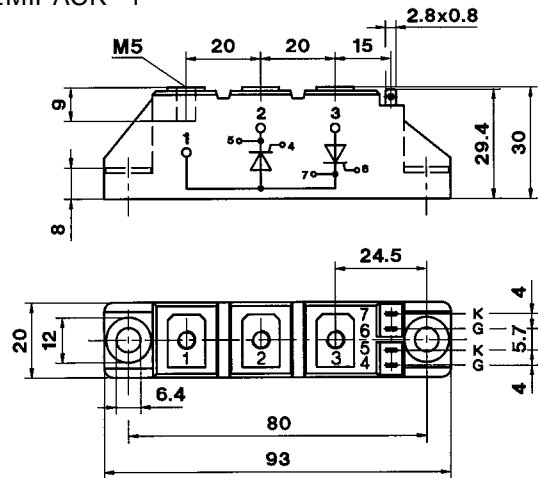

Dimensions in mm

## SKKH 26 ... 105

Case A 6

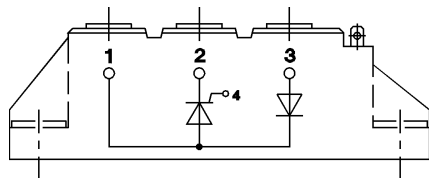

## SKKD 26 ... 100

Case A 10

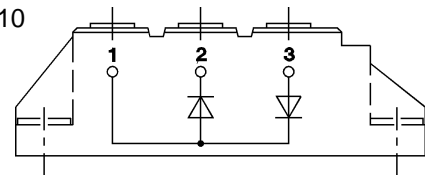

## SKNH 56 ... 91

Case A 7

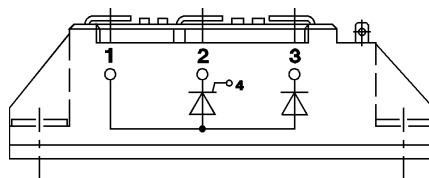

## SKKE 81

Case A 12

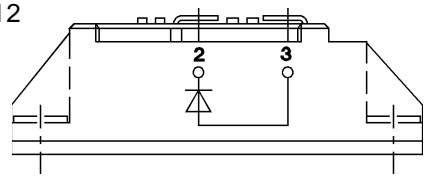

## SKKL 56 ... 105

Case A 9

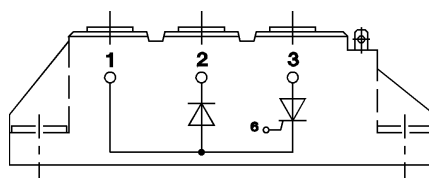

## SKKH 27 ... 106

Case A 47

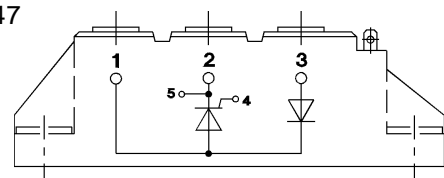

## SKND 46 ... 81

Case A 19

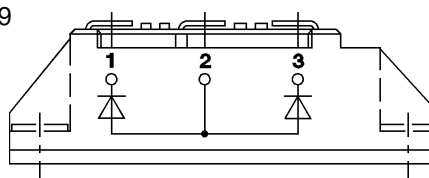

## SKKT 20 B ... 106 B

Case A 48

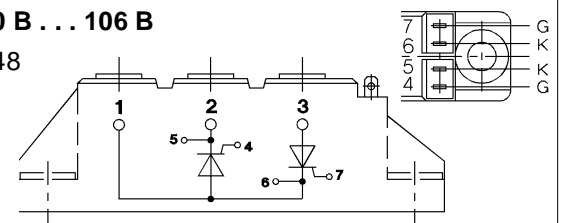

## SKMT 92

Case A 72

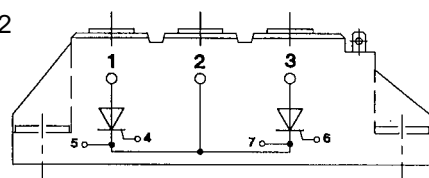

## SKKL 42 ... 106

Case A 59

