

# IRFB17N50L

## SMPS MOSFET

HEXFET® Power MOSFET

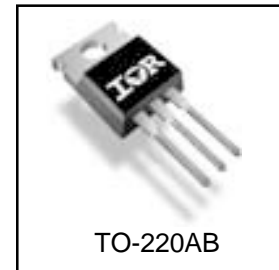
### Applications

- Switch Mode Power Supply (SMPS)
- Uninterruptible Power Supply
- High Speed Power Switching
- ZVS and High Frequency Circuit
- PWM Inverters

V <sub>DSS</sub>	R <sub>DS(on) typ.</sub>	I <sub>D</sub>
500V	0.28Ω	16A

### Benefits

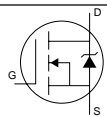
- Low Gate Charge Q<sub>g</sub> results in Simple Drive Requirement
- Improved Gate, Avalanche and Dynamic dv/dt Ruggedness
- Fully Characterized Capacitance and Avalanche Voltage and Current
- Low T<sub>rr</sub> and Soft Diode Recovery
- High Performance Optimised Anti-parallel Diode



### Absolute Maximum Ratings

	Parameter	Max.	Units
I <sub>D</sub> @ T <sub>C</sub> = 25°C	Continuous Drain Current, V <sub>GS</sub> @ 10V	16	A
I <sub>D</sub> @ T <sub>C</sub> = 100°C	Continuous Drain Current, V <sub>GS</sub> @ 10V	11	
I <sub>DM</sub>	Pulsed Drain Current ①	64	
P <sub>D</sub> @ T <sub>C</sub> = 25°C	Power Dissipation	220	W
	Linear Derating Factor	1.8	W/°C
V <sub>GS</sub>	Gate-to-Source Voltage	± 30	V
dv/dt	Peak Diode Recovery dv/dt ③	13	V/ns
T <sub>J</sub>	Operating Junction and	-55 to + 150	°C
T <sub>STG</sub>	Storage Temperature Range		
	Soldering Temperature, for 10 seconds (1.6mm from case )	300	
	Mounting Torque, 6-32 or M3 screw	10	lbf.in(N.m)

### Diode Characteristics

Symbol	Parameter	Min.	Typ.	Max.	Units	Conditions
I <sub>S</sub>	Continuous Source Current (Body Diode)	—	—	16	A	MOSFET symbol showing the integral reverse p-n junction diode. 
I <sub>SM</sub>	Pulsed Source Current (Body Diode) ①	—	—	64		
V <sub>SD</sub>	Diode Forward Voltage	—	—	1.5	V	T <sub>J</sub> = 25°C, I <sub>S</sub> = 16A, V <sub>GS</sub> = 0V ④
t <sub>rr</sub>	Reverse Recovery Time	—	170	250	ns	T <sub>J</sub> = 25°C I <sub>F</sub> = 16A T <sub>J</sub> = 125°C di/dt = 100A/μs ④
Q <sub>rr</sub>	Reverse Recovery Charge	—	470	710		
I <sub>R</sub>	Reverse Recovery Current	—	810	1210	nC	T <sub>J</sub> = 25°C T <sub>J</sub> = 125°C
t <sub>on</sub>	Forward Turn-On Time	Intrinsic turn-on time is negligible (turn-on is dominated by L <sub>S</sub> +L <sub>D</sub> )				

### Typical SMPS Topologies

- Bridge Converters
- All Zero Voltage Switching

www.irf.com

# IRFB17N50L

International  
IR Rectifier

## Static @ $T_J = 25^\circ\text{C}$ (unless otherwise specified)

Symbol	Parameter	Min.	Typ.	Max.	Units	Conditions
$V_{(BR)DSS}$	Drain-to-Source Breakdown Voltage	500	—	—	V	$V_{GS} = 0V, I_D = 250\mu A$
$\Delta V_{(BR)DSS}/\Delta T_J$	Breakdown Voltage Temp. Coefficient	—	0.6	—	V/°C	Reference to $25^\circ\text{C}, I_D = 1\text{mA}$ ⑥
$R_{DS(on)}$	Static Drain-to-Source On-Resistance	—	0.28	0.32	$\Omega$	$V_{GS} = 10V, I_D = 9.9A$ ④
$V_{GS(th)}$	Gate Threshold Voltage	3.0	—	5.0	V	$V_{DS} = V_{GS}, I_D = 250\mu A$
$I_{DSS}$	Drain-to-Source Leakage Current	—	—	50	$\mu A$	$V_{DS} = 500V, V_{GS} = 0V$
		—	—	2.0	mA	$V_{DS} = 400V, V_{GS} = 0V, T_J = 125^\circ\text{C}$
$I_{GSS}$	Gate-to-Source Forward Leakage	—	—	100	nA	$V_{GS} = 30V$
	Gate-to-Source Reverse Leakage	—	—	-100		$V_{GS} = -30V$

## Dynamic @ $T_J = 25^\circ\text{C}$ (unless otherwise specified)

Symbol	Parameter	Min.	Typ.	Max.	Units	Conditions
$g_{fs}$	Forward Transconductance	11	—	—	S	$V_{DS} = 50V, I_D = 9.9A$
$Q_g$	Total Gate Charge	—	—	130	nC	$I_D = 16A$
$Q_{gs}$	Gate-to-Source Charge	—	—	33		$V_{DS} = 400V$
$Q_{gd}$	Gate-to-Drain ("Miller") Charge	—	—	59		$V_{GS} = 10V$ ④
$t_{d(on)}$	Turn-On Delay Time	—	21	—	ns	$V_{DD} = 250V$
$t_r$	Rise Time	—	51	—		$I_D = 16A$
$t_{d(off)}$	Turn-Off Delay Time	—	50	—		$R_G = 7.5\Omega$
$t_f$	Fall Time	—	28	—		$V_{GS} = 10V$ ④
$C_{iss}$	Input Capacitance	—	2760	—	pF	$V_{GS} = 0V$
$C_{oss}$	Output Capacitance	—	325	—		$V_{DS} = 25V$
$C_{rSS}$	Reverse Transfer Capacitance	—	37	—		$f = 1.0\text{MHz}$
$C_{oss}$	Output Capacitance	—	3690	—		$V_{GS} = 0V, V_{DS} = 1.0V, f = 1.0\text{MHz}$
$C_{oss}$	Output Capacitance	—	84	—		$V_{GS} = 0V, V_{DS} = 400V, f = 1.0\text{MHz}$
$C_{oss \text{ eff.}}$	Effective Output Capacitance	—	159	—		$V_{GS} = 0V, V_{DS} = 0V \text{ to } 400V$ ⑤

## Avalanche Characteristics

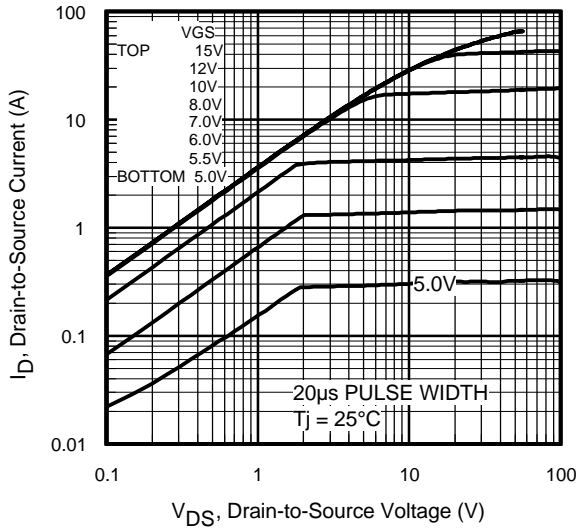
Symbol	Parameter	Typ.	Max.	Units
$E_{AS}$	Single Pulse Avalanche Energy②	—	390	mJ
$I_{AR}$	Avalanche Current①	—	16	A
$E_{AR}$	Repetitive Avalanche Energy①	—	22	mJ

## Thermal Resistance

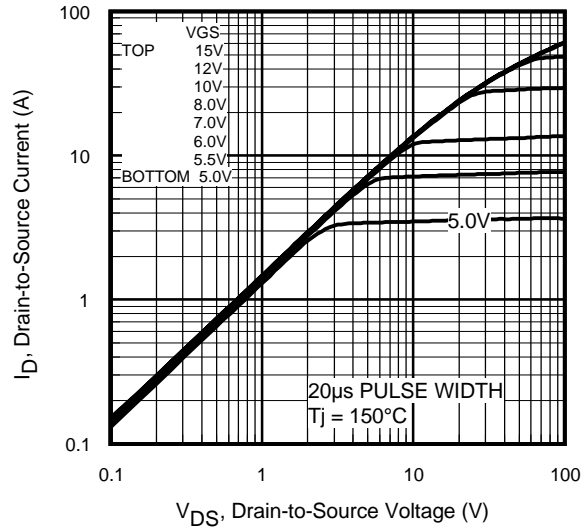
Symbol	Parameter	Typ.	Max.	Units
$R_{\theta JC}$	Junction-to-Case	—	0.56	°C/W
$R_{\theta CS}$	Case-to-Sink, Flat, Greased Surface	0.50	—	
$R_{\theta JA}$	Junction-to-Ambient	—	62	

### Notes:

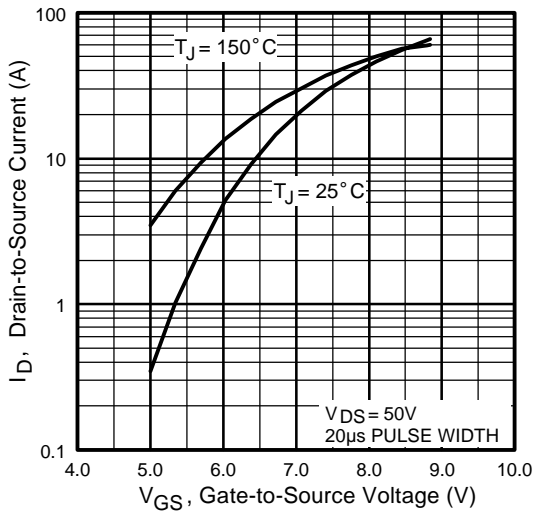
- ① Repetitive rating; pulse width limited by max. junction temperature.      ④ Pulse width  $\leq 300\mu s$ ; duty cycle  $\leq 2\%$ .
- ② Starting  $T_J = 25^\circ\text{C}$ ,  $L = 3.0\text{mH}$ ,  $R_G = 25\Omega$ ,  $I_{AS} = 16A$ .
- ③  $I_{SD} \leq 16A$ ,  $di/dt \leq 347A/\mu s$ ,  $V_{DD} \leq V_{(BR)DSS}$ ,  $T_J \leq 150^\circ\text{C}$



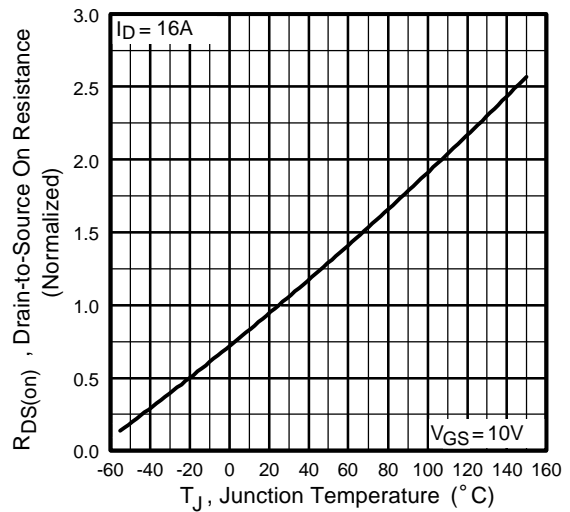
**Fig 1.** Typical Output Characteristics



**Fig 2.** Typical Output Characteristics



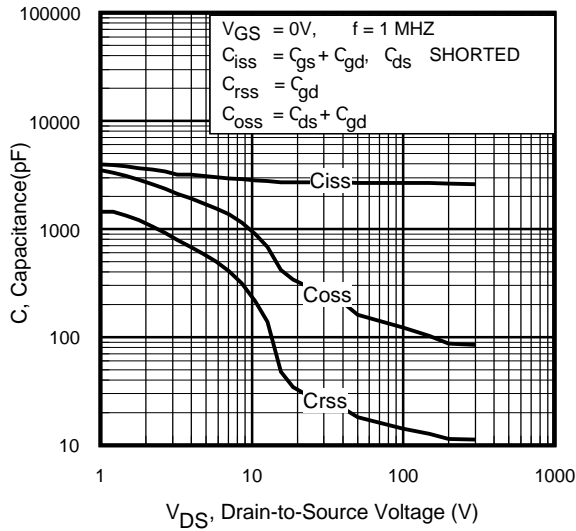
**Fig 3.** Typical Transfer Characteristics



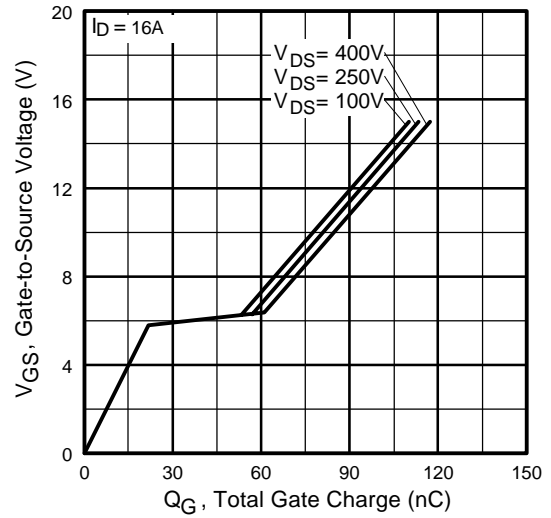
**Fig 4.** Normalized On-Resistance Vs. Temperature

# IRFB17N50L

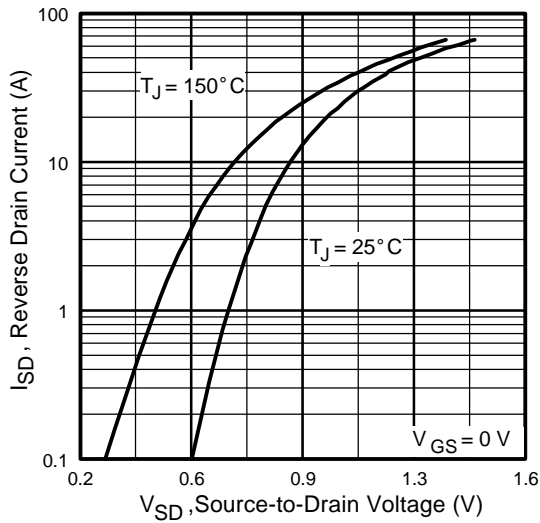
International  
**IR** Rectifier



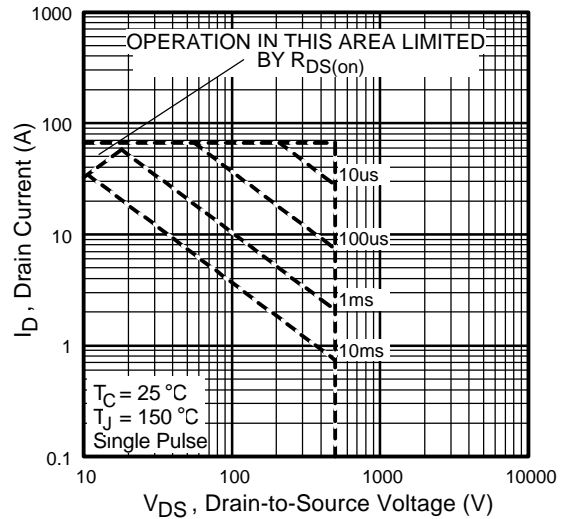
**Fig 5.** Typical Capacitance Vs. Drain-to-Source Voltage



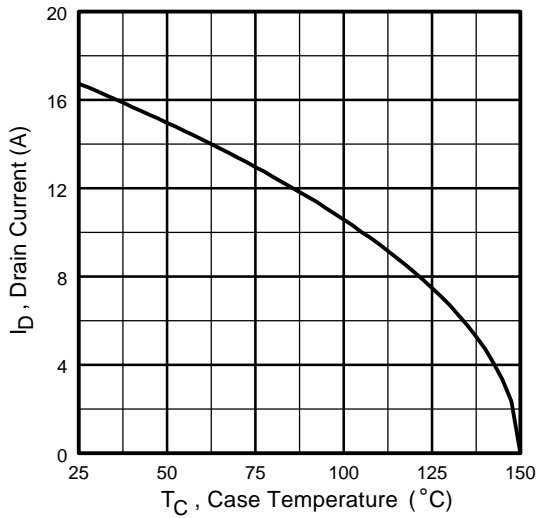
**Fig 6.** Typical Gate Charge Vs. Gate-to-Source Voltage



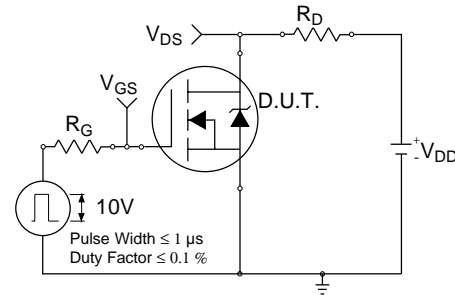
**Fig 7.** Typical Source-Drain Diode Forward Voltage



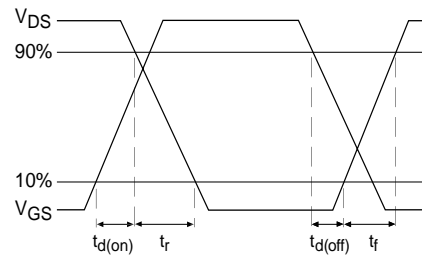
**Fig 8.** Maximum Safe Operating Area



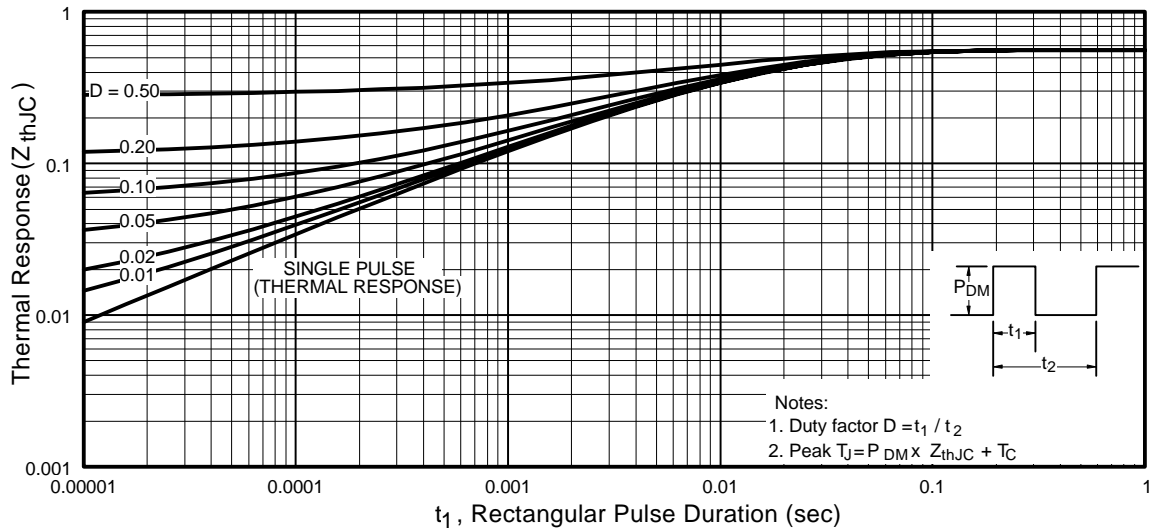
**Fig 9.** Maximum Drain Current Vs. Case Temperature



**Fig 10a.** Switching Time Test Circuit

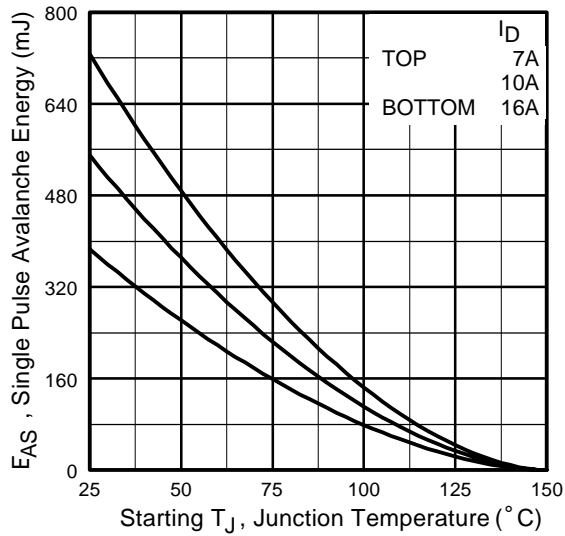


**Fig 10b.** Switching Time Waveforms

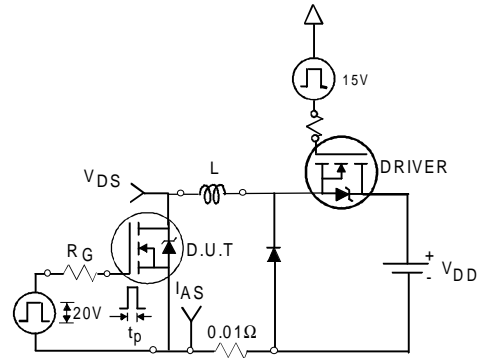


**Fig 11.** Maximum Effective Transient Thermal Impedance, Junction-to-Case

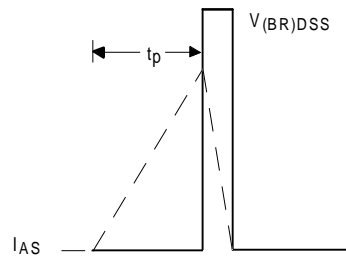
# IRFB17N50L



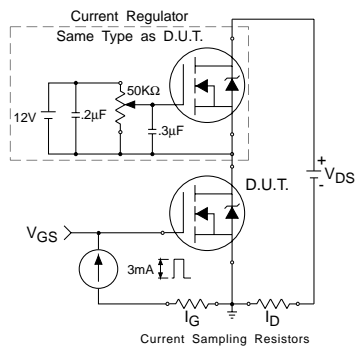
**Fig 12a.** Maximum Avalanche Energy Vs. Drain Current



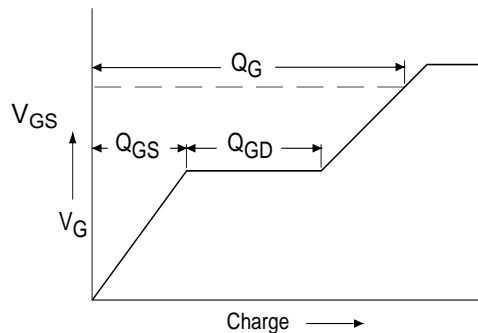
**Fig 12c.** Unclamped Inductive Test Circuit



**Fig 12d.** Unclamped Inductive Waveforms

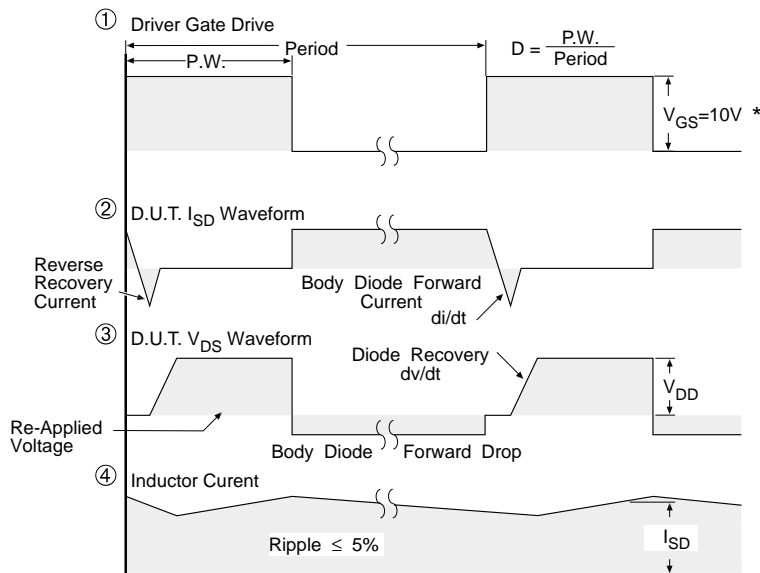
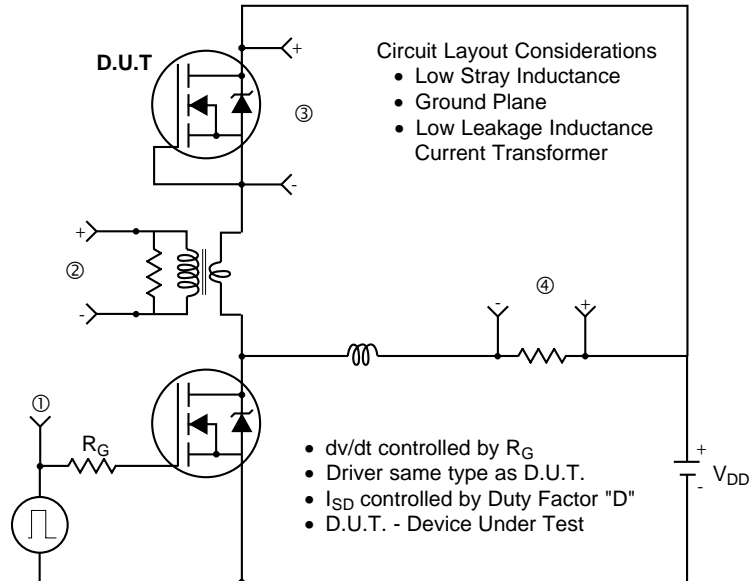


**Fig 13a.** Gate Charge Test Circuit



**Fig 13b.** Basic Gate Charge Waveform

## Peak Diode Recovery dv/dt Test Circuit



\*  $V_{GS} = 5V$  for Logic Level Devices

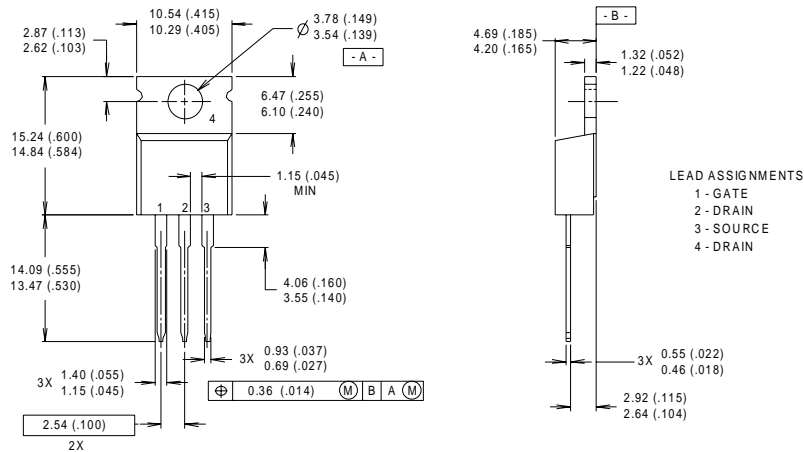
**Fig 14.** For N-Channel HEXFET® Power MOSFETs

# IRFB17N50L

International  
**IR** Rectifier

## TO-220AB Package Outline

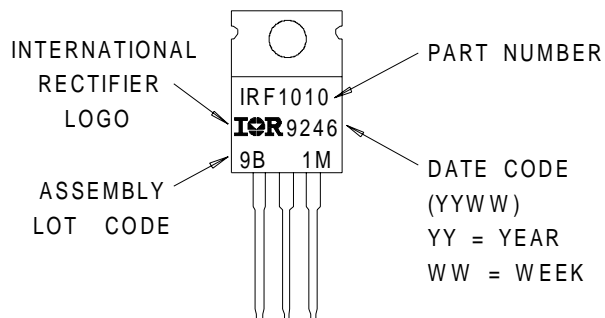
Dimensions are shown in millimeters (inches)



- NOTES:  
1 DIMENSIONING & TOLERANCING PER ANS Y14.5M, 1982.  
2 CONTROLLING DIMENSION : INCH  
3 OUTLINE CONFORMS TO JEDEC OUTLINE TO-220AB.  
4 HEATSINK & LEAD MEASUREMENTS DO NOT INCLUDE BURRS.

## TO-220AB Part Marking Information

EXAMPLE : THIS IS AN IRF1010  
WITH ASSEMBLY  
LOT CODE 9B1M



Data and specifications subject to change without notice.  
This product has been designed and qualified for the industrial market.  
Qualification Standards can be found on IR's Web site.

International  
**IR** Rectifier

IR WORLD HEADQUARTERS: 233 Kansas St., El Segundo, California 90245, USA Tel: (310) 252-7105  
TAC Fax: (310) 252-7903

Visit us at [www.irf.com](http://www.irf.com) for sales contact information.03/01

[www.irf.com](http://www.irf.com)