

WARP2 SERIES IGBT WITH
ULTRAFAST SOFT RECOVERY DIODE

Applications

- Telecom and Server SMPS
- PFC and ZVS SMPS Circuits
- Uninterruptable Power Supplies
- Consumer Electronics Power Supplies

Features

- NPT Technology, Positive Temperature Coefficient
- Lower $V_{CE(SAT)}$
- Lower Parasitic Capacitances
- Minimal Tail Current
- HEXFRED Ultra Fast Soft-Recovery Co-Pack Diode
- Tighter Distribution of Parameters
- Higher Reliability

Benefits

- Parallel Operation for Higher Current Applications
- Lower Conduction Losses and Switching Losses
- Higher Switching Frequency up to 150kHz

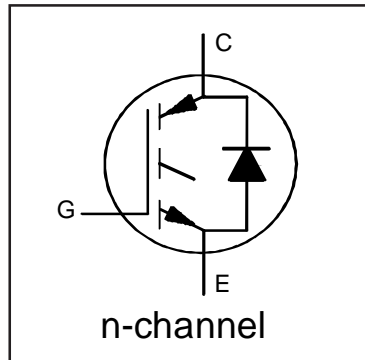

$V_{CES} = 600V$
 $V_{CE(on)} \text{ typ.} = 1.85V$
 @ $V_{GE} = 15V$ $I_C = 22A$

Equivalent MOSFET Parameters^①

$R_{CE(on)} \text{ typ.} = 84m\Omega$
 I_D (FET equivalent) = 35A

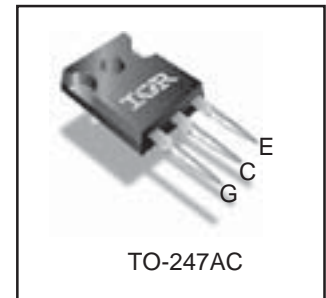

Absolute Maximum Ratings

	Parameter	Max.	Units
V_{CES}	Collector-to-Emitter Voltage	600	V
$I_C @ T_C = 25^\circ C$	Continuous Collector Current	60	A
$I_C @ T_C = 100^\circ C$	Continuous Collector Current	34	
I_{CM}	Pulse Collector Current (Ref. Fig. C.T.4)	120	
I_{LM}	Clamped Inductive Load Current ^②	120	
$I_F @ T_C = 25^\circ C$	Diode Continuous Forward Current	40	
$I_F @ T_C = 100^\circ C$	Diode Continuous Forward Current	15	
I_{FRM}	Maximum Repetitive Forward Current ^③	60	
V_{GE}	Gate-to-Emitter Voltage	± 20	V
$P_D @ T_C = 25^\circ C$	Maximum Power Dissipation	308	W
$P_D @ T_C = 100^\circ C$	Maximum Power Dissipation	123	
T_J	Operating Junction and	-55 to +150	°C
T_{STG}	Storage Temperature Range		
	Soldering Temperature for 10 sec.		
	Mounting Torque, 6-32 or M3 Screw	10 lbf-in (1.1 N·m)	

Thermal Resistance

	Parameter	Min.	Typ.	Max.	Units
$R_{\theta JC}$ (IGBT)	Thermal Resistance Junction-to-Case-(each IGBT)	—	—	0.41	°C/W
$R_{\theta JC}$ (Diode)	Thermal Resistance Junction-to-Case-(each Diode)	—	—	1.7	
$R_{\theta CS}$	Thermal Resistance, Case-to-Sink (flat, greased surface)	—	0.50	—	
$R_{\theta JA}$	Thermal Resistance, Junction-to-Ambient (typical socket mount)	—	—	40	
	Weight	—	6.0 (0.21)	—	g (oz)

Electrical Characteristics @ $T_J = 25^\circ\text{C}$ (unless otherwise specified)

	Parameter	Min.	Typ.	Max.	Units	Conditions	Ref.Fig
$V_{(BR)CES}$	Collector-to-Emitter Breakdown Voltage	600	—	—	V	$V_{GE} = 0V, I_C = 500\mu A$	
$\Delta V_{(BR)CES}/\Delta T_J$	Temperature Coeff. of Breakdown Voltage	—	0.78	—	V/°C	$V_{GE} = 0V, I_C = 1mA (25^\circ\text{C}-125^\circ\text{C})$	
R_G	Internal Gate Resistance	—	1.7	—	Ω	1MHz, Open Collector	
$V_{CE(on)}$	Collector-to-Emitter Saturation Voltage	—	1.85	2.15	V	$I_C = 22A, V_{GE} = 15V$	4, 5, 6, 8, 9
		—	2.25	2.55		$I_C = 35A, V_{GE} = 15V$	
		—	2.37	2.80		$I_C = 22A, V_{GE} = 15V, T_J = 125^\circ\text{C}$	
		—	3.00	3.45		$I_C = 35A, V_{GE} = 15V, T_J = 125^\circ\text{C}$	
$V_{GE(th)}$	Gate Threshold Voltage	3.0	4.0	5.0	V	$I_C = 250\mu A$	7, 8, 9
$\Delta V_{GE(th)}/\Delta T_J$	Threshold Voltage temp. coefficient	—	-10	—	mV/°C	$V_{CE} = V_{GE}, I_C = 1.0mA$	
g_{fe}	Forward Transconductance	—	36	—	S	$V_{CE} = 50V, I_C = 22A, PW = 80\mu s$	
I_{CES}	Collector-to-Emitter Leakage Current	—	3.0	375	μA	$V_{GE} = 0V, V_{CE} = 600V$	
		—	0.35	—	mA	$V_{GE} = 0V, V_{CE} = 600V, T_J = 125^\circ\text{C}$	
V_{FM}	Diode Forward Voltage Drop	—	1.30	1.70	V	$I_F = 15A, V_{GE} = 0V$	10
		—	1.20	1.60		$I_F = 15A, V_{GE} = 0V, T_J = 125^\circ\text{C}$	
I_{GES}	Gate-to-Emitter Leakage Current	—	—	± 100	nA	$V_{GE} = \pm 20V, V_{CE} = 0V$	

Switching Characteristics @ $T_J = 25^\circ\text{C}$ (unless otherwise specified)

	Parameter	Min.	Typ.	Max.	Units	Conditions	Ref.Fig
Q_g	Total Gate Charge (turn-on)	—	160	240	nC	$I_C = 22A$	17
Q_{gc}	Gate-to-Collector Charge (turn-on)	—	55	83		$V_{CC} = 400V$	CT1
Q_{ge}	Gate-to-Emitter Charge (turn-on)	—	21	32		$V_{GE} = 15V$	
E_{on}	Turn-On Switching Loss	—	220	270	μJ	$I_C = 22A, V_{CC} = 390V$	CT3
E_{off}	Turn-Off Switching Loss	—	215	265		$V_{GE} = +15V, R_G = 3.3\Omega, L = 200\mu H$	
E_{total}	Total Switching Loss	—	435	535		$T_J = 25^\circ\text{C} \text{ (4)}$	
$t_{d(on)}$	Turn-On delay time	—	26	34	ns	$I_C = 22A, V_{CC} = 390V$	CT3
t_r	Rise time	—	6.0	8.0		$V_{GE} = +15V, R_G = 3.3\Omega, L = 200\mu H$	
$t_{d(off)}$	Turn-Off delay time	—	110	122		$T_J = 25^\circ\text{C} \text{ (4)}$	
t_f	Fall time	—	8.0	10	μJ	$I_C = 22A, V_{CC} = 390V$	CT3
E_{on}	Turn-On Switching Loss	—	410	465		$V_{GE} = +15V, R_G = 3.3\Omega, L = 200\mu H$	11, 13
E_{off}	Turn-Off Switching Loss	—	330	405		$T_J = 125^\circ\text{C} \text{ (4)}$	WF1, WF2
E_{total}	Total Switching Loss	—	740	870	ns	$I_C = 22A, V_{CC} = 390V$	CT3
$t_{d(on)}$	Turn-On delay time	—	26	34		$V_{GE} = +15V, R_G = 3.3\Omega, L = 200\mu H$	12, 14
t_r	Rise time	—	8.0	11		$T_J = 125^\circ\text{C} \text{ (4)}$	WF1, WF2
$t_{d(off)}$	Turn-Off delay time	—	130	150	pF	$V_{GE} = 0V$	16
t_f	Fall time	—	12	16		$V_{CC} = 30V$	
C_{ies}	Input Capacitance	—	3715	—		$f = 1Mhz$	
C_{oes}	Output Capacitance	—	265	—	pF	$V_{GE} = 0V, V_{CE} = 0V \text{ to } 480V$	15
C_{res}	Reverse Transfer Capacitance	—	47	—			
$C_{oes \text{ eff.}}$	Effective Output Capacitance (Time Related) (5)	—	135	—			
$C_{oes \text{ eff. (ER)}}$	Effective Output Capacitance (Energy Related) (5)	—	179	—			
RBSOA	Reverse Bias Safe Operating Area	FULL SQUARE				$T_J = 150^\circ\text{C}, I_C = 120A$ $V_{CC} = 480V, V_p = 600V$ $R_g = 22\Omega, V_{GE} = +15V \text{ to } 0V$	3 CT2
t_{rr}	Diode Reverse Recovery Time	—	42	60	ns	$T_J = 25^\circ\text{C}$ $I_F = 15A, V_R = 200V,$	19
		—	74	120		$T_J = 125^\circ\text{C}$ $di/dt = 200A/\mu s$	
Q_{rr}	Diode Reverse Recovery Charge	—	80	180	nC	$T_J = 25^\circ\text{C}$ $I_F = 15A, V_R = 200V,$	21
		—	220	600		$T_J = 125^\circ\text{C}$ $di/dt = 200A/\mu s$	
I_{rr}	Peak Reverse Recovery Current	—	4.0	6.0	A	$T_J = 25^\circ\text{C}$ $I_F = 15A, V_R = 200V,$	19, 20, 21, 22
		—	6.5	10		$T_J = 125^\circ\text{C}$ $di/dt = 200A/\mu s$	

Notes:

(1) $R_{CE(on)}$ typ. = equivalent on-resistance = $V_{CE(on)}$ typ. / I_C , where $V_{CE(on)}$ typ. = 1.85V and $I_C = 22A$. I_D (FET Equivalent) is the equivalent MOSFET I_D rating @ 25°C for applications up to 150kHz. These are provided for comparison purposes (only) with equivalent MOSFET solutions.

(2) $V_{CC} = 80\% (V_{CES}), V_{GE} = 15V, L = 28 \mu H, R_G = 22 \Omega$.

(3) Pulse width limited by max. junction temperature.

(4) Energy losses include "tail" and diode reverse recovery, Data generated with use of Diode 30ETH06.

(5) $C_{oes \text{ eff.}}$ is a fixed capacitance that gives the same charging time as C_{oes} while V_{CE} is rising from 0 to 80% V_{CES} .

$C_{oes \text{ eff. (ER)}}$ is a fixed capacitance that stores the same energy as C_{oes} while V_{CE} is rising from 0 to 80% V_{CES} .

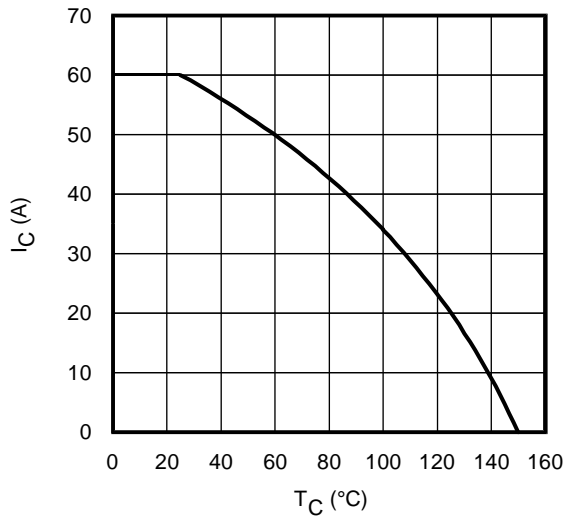

Fig. 1 - Maximum DC Collector Current vs. Case Temperature

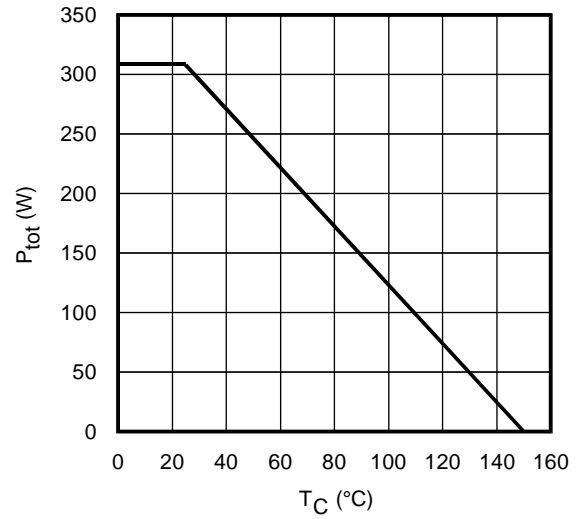

Fig. 2 - Power Dissipation vs. Case Temperature

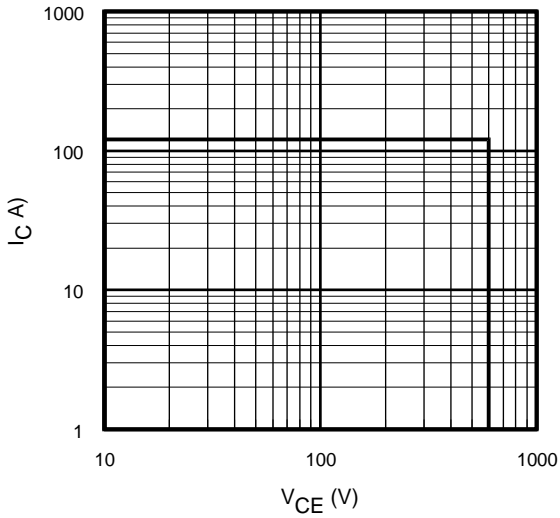

Fig. 3 - Reverse Bias SOA
 $T_J = 150^\circ\text{C}$; $V_{GE} = 15\text{V}$

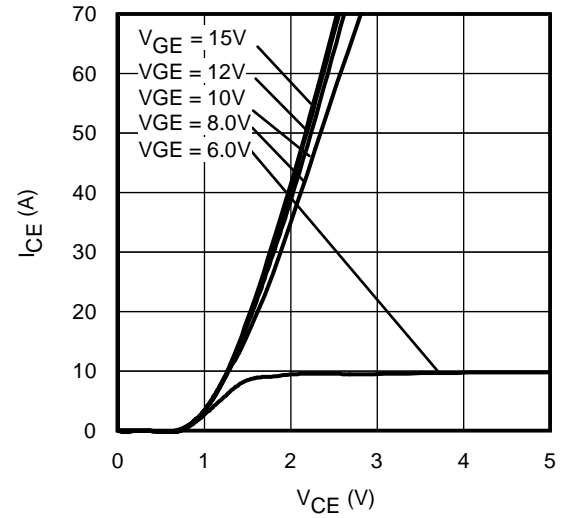

Fig. 4 - Typ. IGBT Output Characteristics
 $T_J = -40^\circ\text{C}$; $t_p = 80\mu\text{s}$

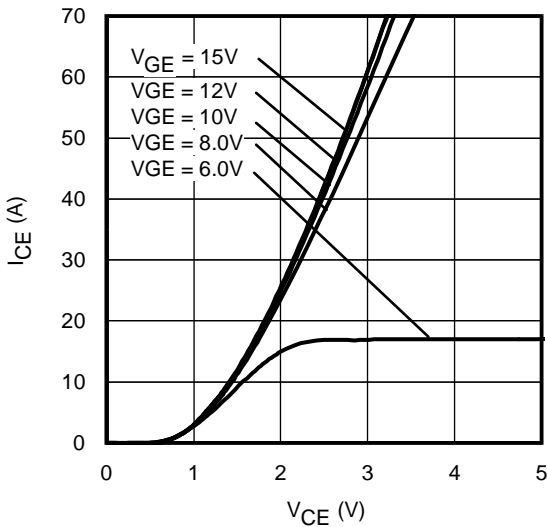

Fig. 5 - Typ. IGBT Output Characteristics
 $T_J = 25^\circ\text{C}$; $t_p = 80\mu\text{s}$

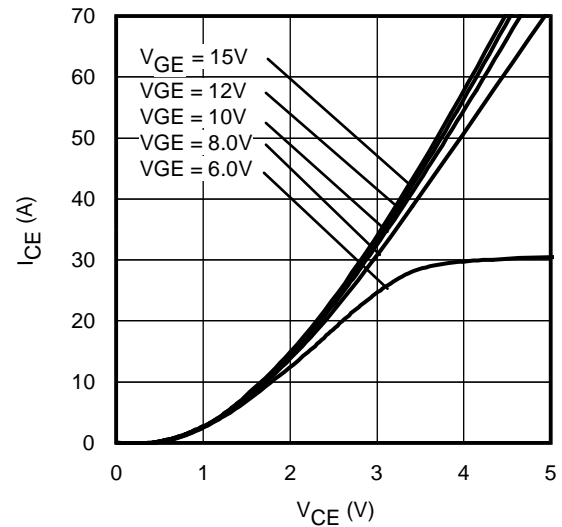

Fig. 6 - Typ. IGBT Output Characteristics
 $T_J = 125^\circ\text{C}$; $t_p = 80\mu\text{s}$

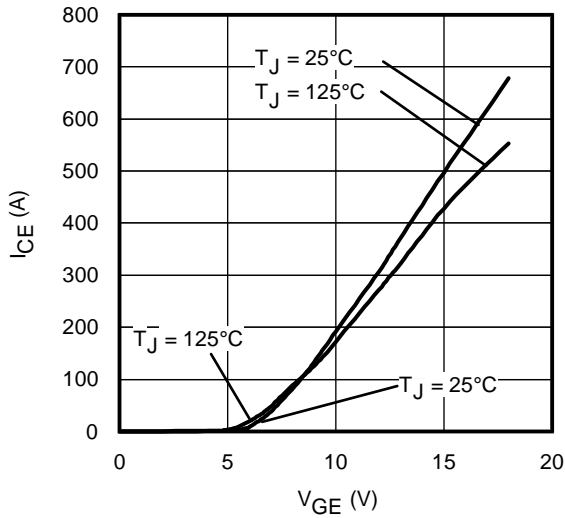

Fig. 7 - Typ. Transfer Characteristics
 $V_{CE} = 50V$; $t_p = 10\mu s$

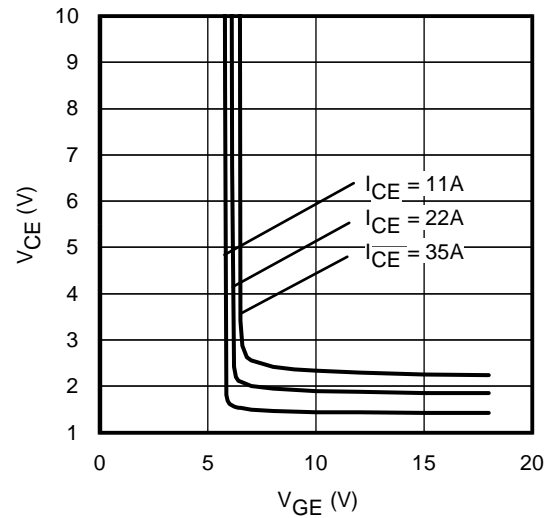

Fig. 8 - Typical V_{CE} vs. V_{GE}
 $T_J = 25^\circ C$

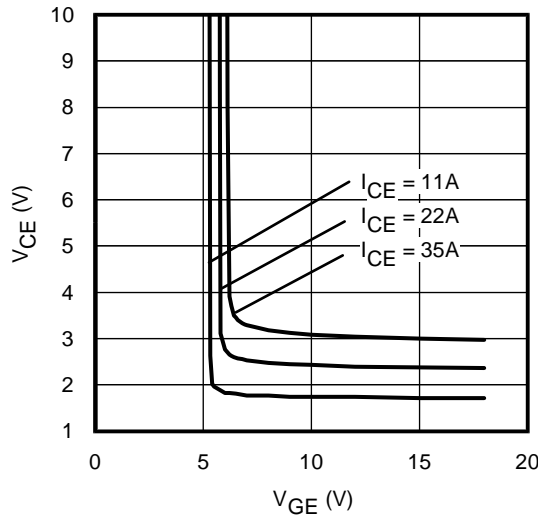

Fig. 9 - Typical V_{CE} vs. V_{GE}
 $T_J = 125^\circ C$

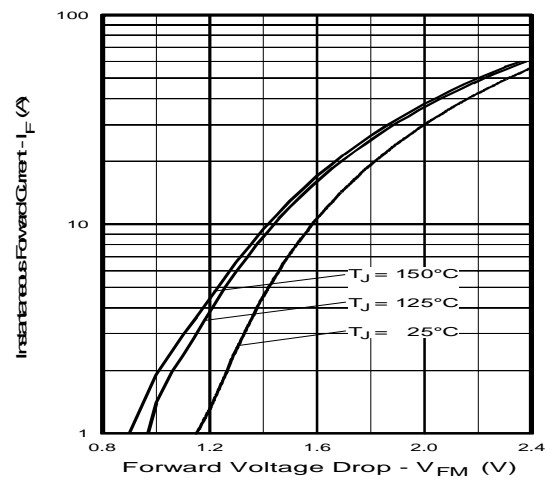

Fig. 10 - Typ. Diode Forward Characteristics
 $t_p = 80\mu s$

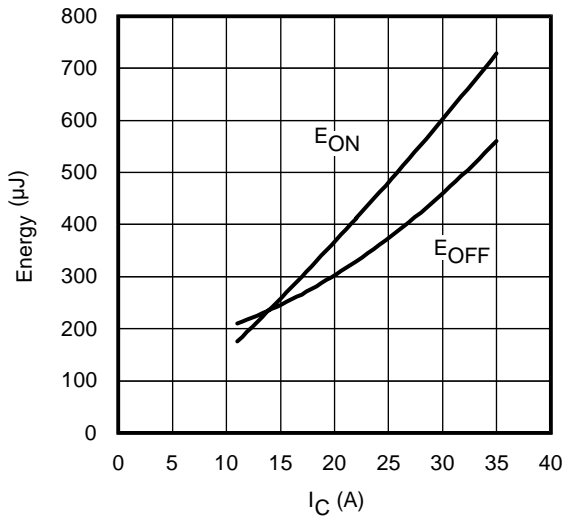

Fig. 11 - Typ. Energy Loss vs. I_C
 $T_J = 125^\circ C$; $L = 200\mu H$; $V_{CE} = 390V$, $R_G = 3.3\Omega$; $V_{GE} = 15V$.
Diode clamp used: 30ETH06 (See C.T.3)

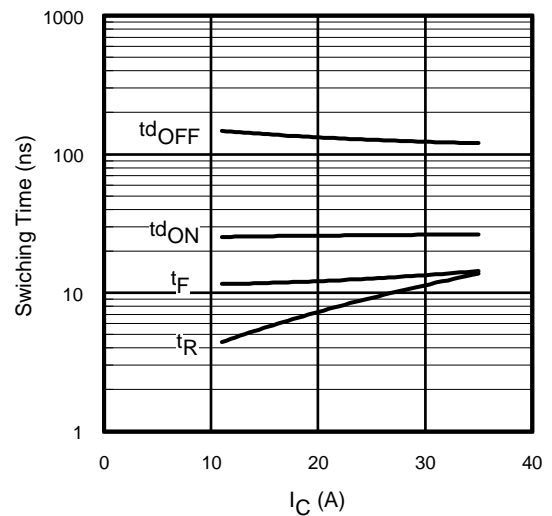

Fig. 12 - Typ. Switching Time vs. I_C
 $T_J = 125^\circ C$; $L = 200\mu H$; $V_{CE} = 390V$, $R_G = 3.3\Omega$; $V_{GE} = 15V$.
Diode clamp used: 30ETH06 (See C.T.3)

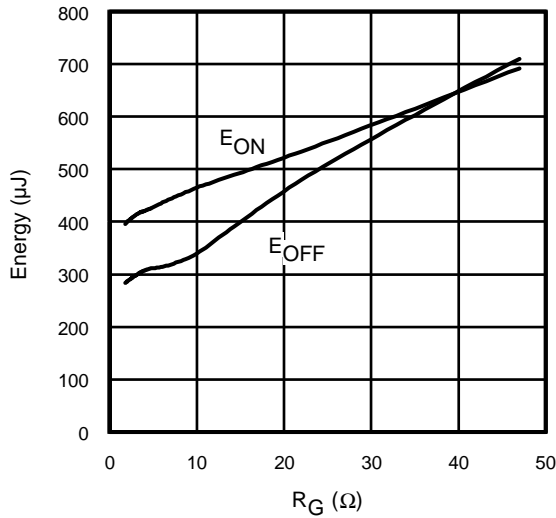

Fig. 13 - Typ. Energy Loss vs. R_G
 $T_J = 125^\circ\text{C}$; $L = 200\mu\text{H}$; $V_{CE} = 390\text{V}$; $I_{CE} = 22\text{A}$; $V_{GE} = 15\text{V}$
 Diode clamp used: 30ETH06 (See C.T.3)

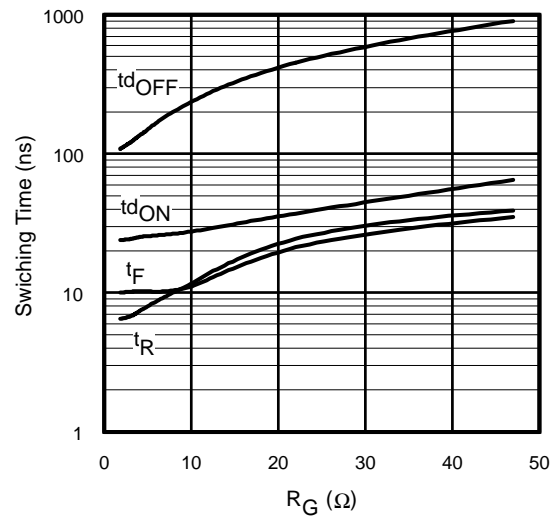
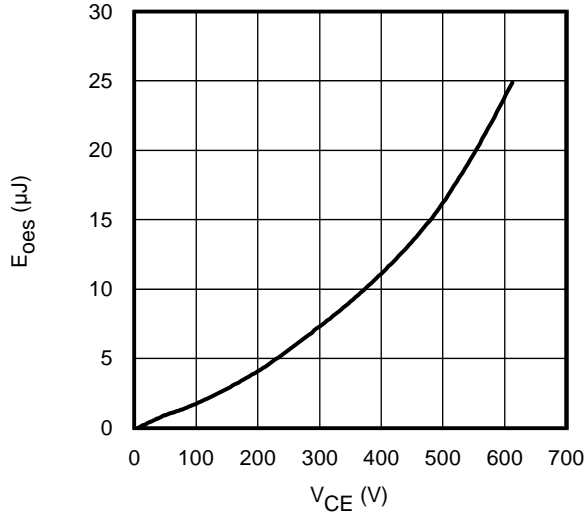

Fig. 14 - Typ. Switching Time vs. R_G
 $T_J = 125^\circ\text{C}$; $L = 200\mu\text{H}$; $V_{CE} = 390\text{V}$; $I_{CE} = 22\text{A}$; $V_{GE} = 15\text{V}$
 Diode clamp used: 30ETH06 (See C.T.3)



**Fig. 15- Typ. Output Capacitance
 Stored Energy vs. V_{CE}**

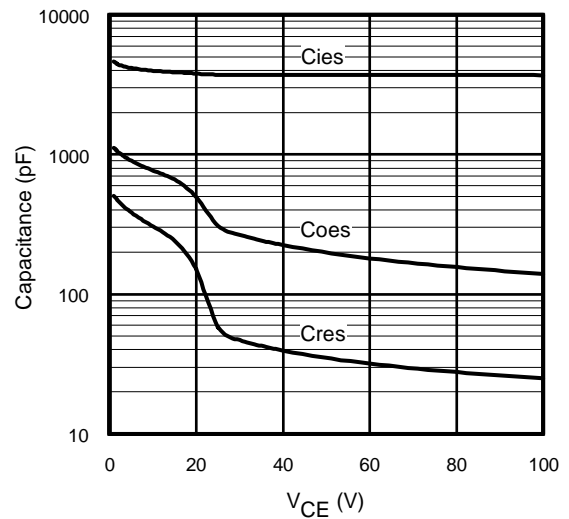

Fig. 16- Typ. Capacitance vs. V_{CE}
 $V_{GE} = 0\text{V}$; $f = 1\text{MHz}$

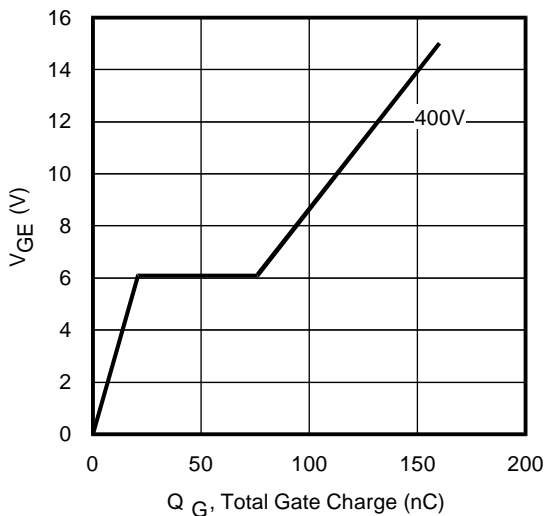
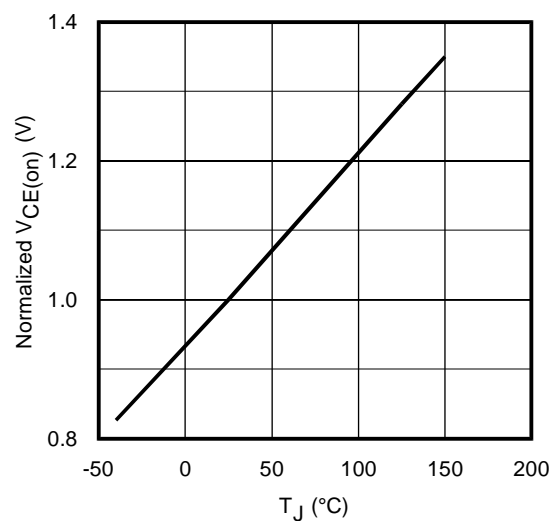

Fig. 17 - Typical Gate Charge vs. V_{GE}
 $I_{CE} = 22\text{A}$



**Fig. 18 - Normalized Typ. $V_{CE(on)}$
 vs. Junction Temperature**
 $I_C = 22\text{A}$, $V_{GE} = 15\text{V}$

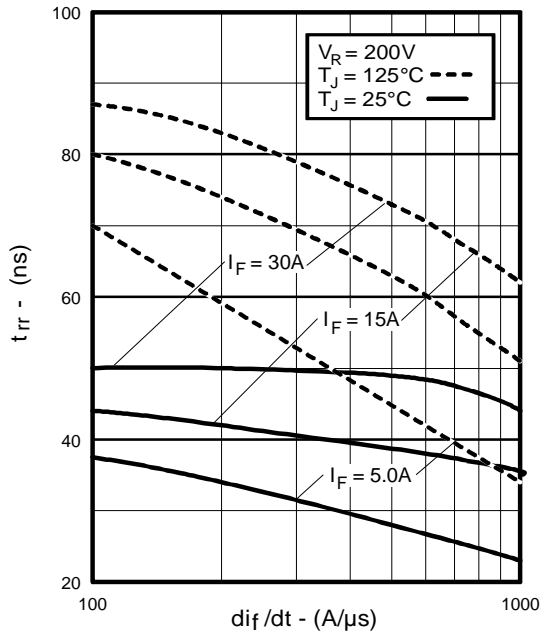

Fig. 19 - Typical Reverse Recovery vs. di_f/dt

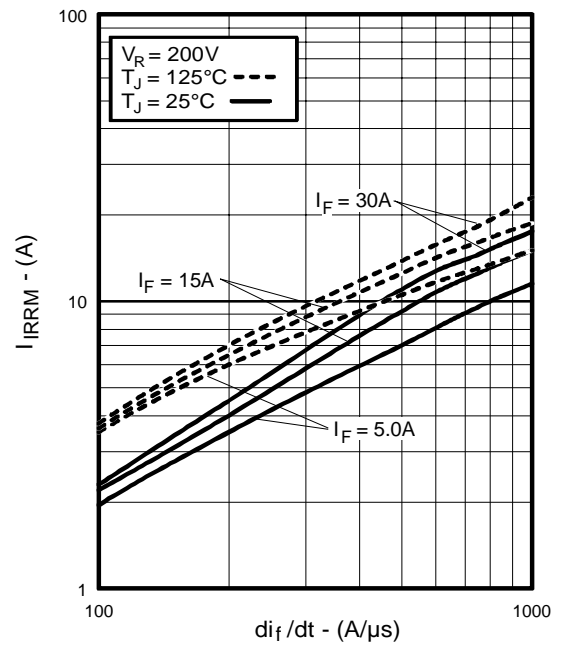

Fig. 20 - Typical Recovery Current vs. di_f/dt

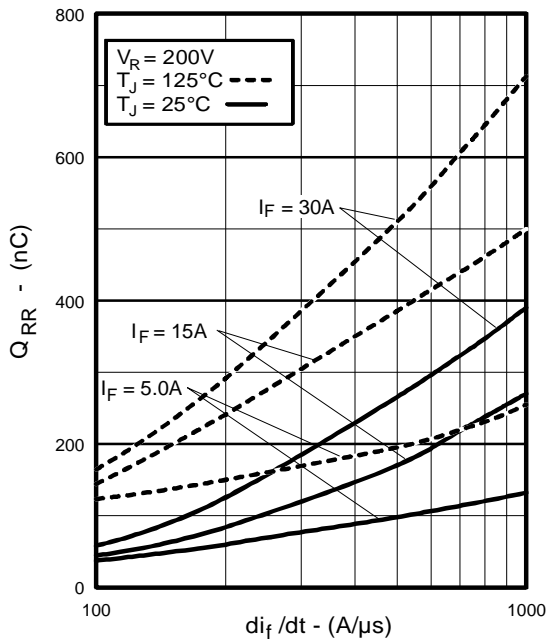

Fig. 21 - Typical Stored Charge vs. di_f/dt

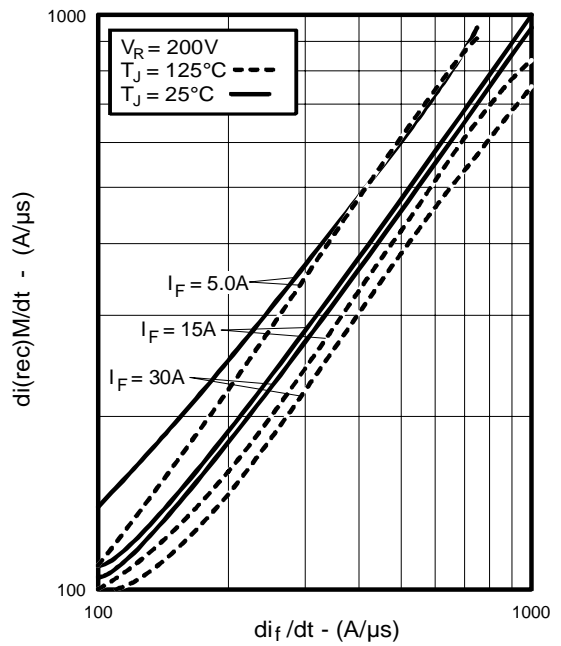

Fig. 22 - Typical $di_{(rec)M}/dt$ vs. di_f/dt

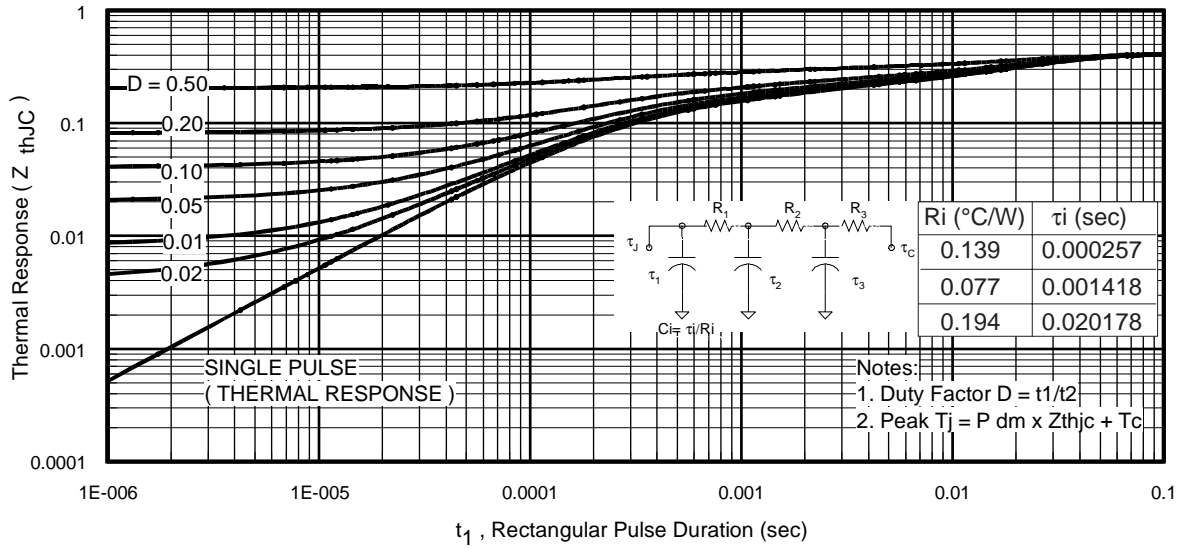

Fig 23. Maximum Transient Thermal Impedance, Junction-to-Case (IGBT)

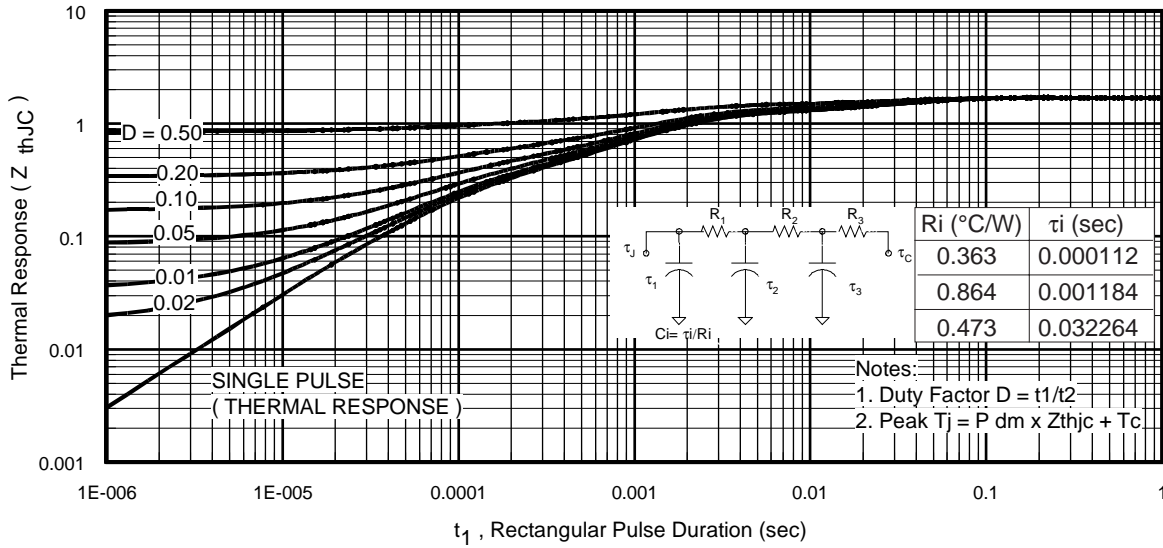

Fig. 24. Maximum Transient Thermal Impedance, Junction-to-Case (DIODE)

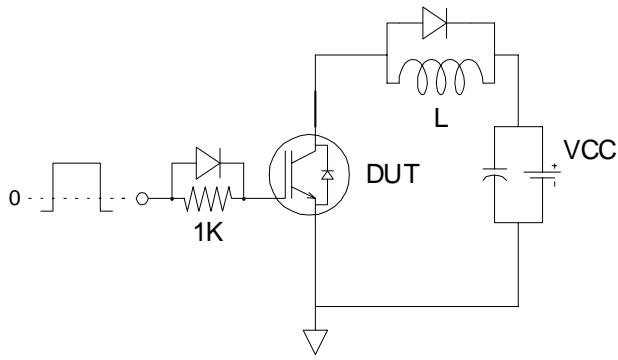

Fig.C.T.1 - Gate Charge Circuit (turn-off)

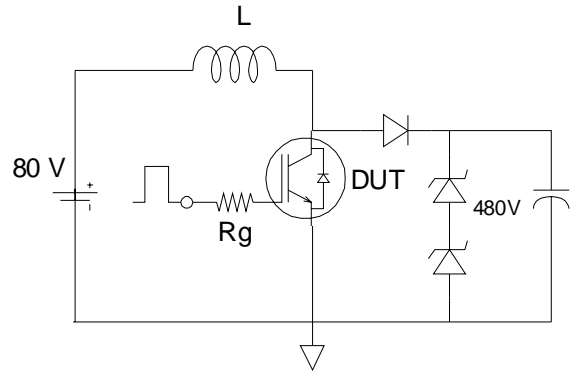

Fig.C.T.2 - RBSOA Circuit

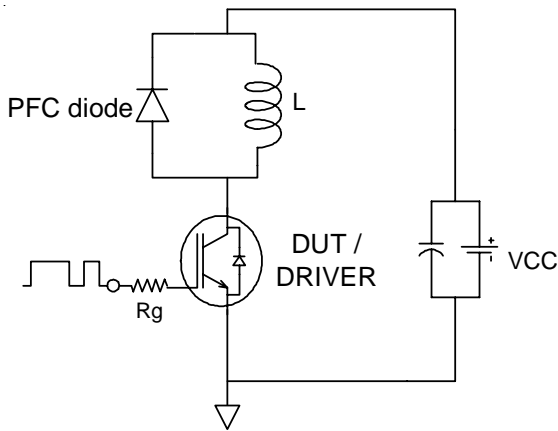

Fig.C.T.3 - Switching Loss Circuit

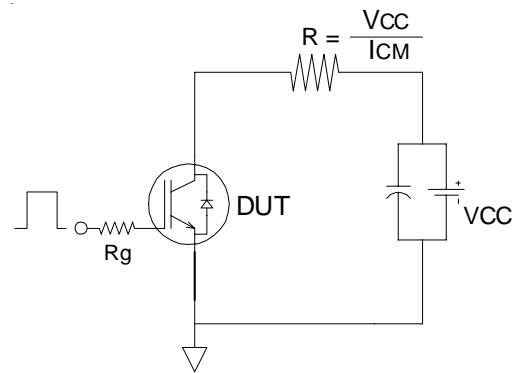

Fig.C.T.4 - Resistive Load Circuit

REVERSE RECOVERY CIRCUIT

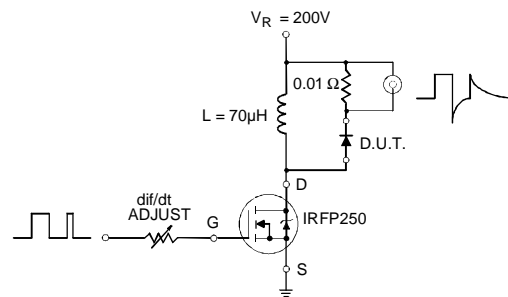

Fig. C.T.5 - Reverse Recovery Parameter Test Circuit

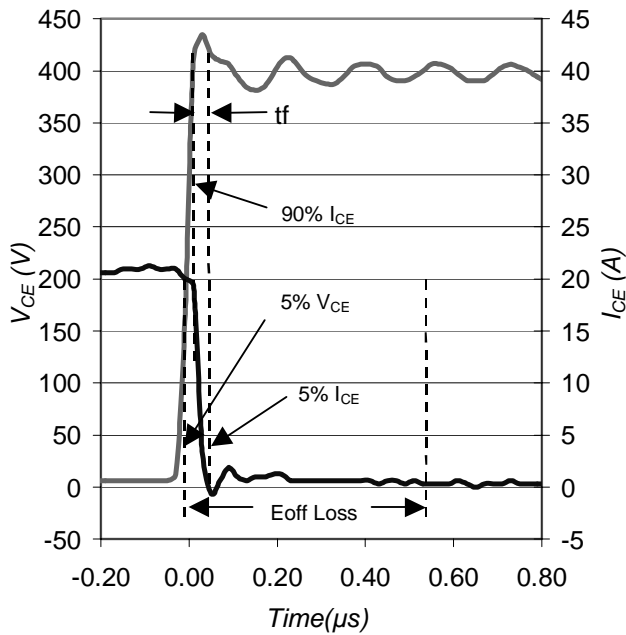

Fig. WF1 - Typ. Turn-off Loss Waveform
@ $T_J = 25^\circ\text{C}$ using Fig. CT.3

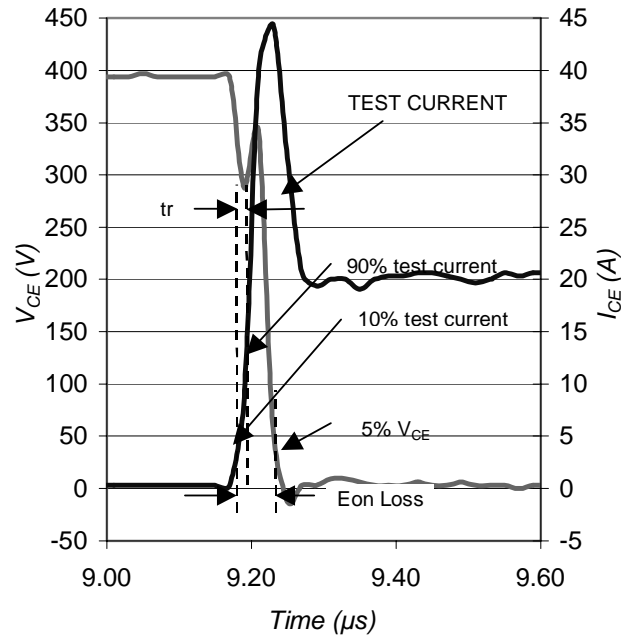
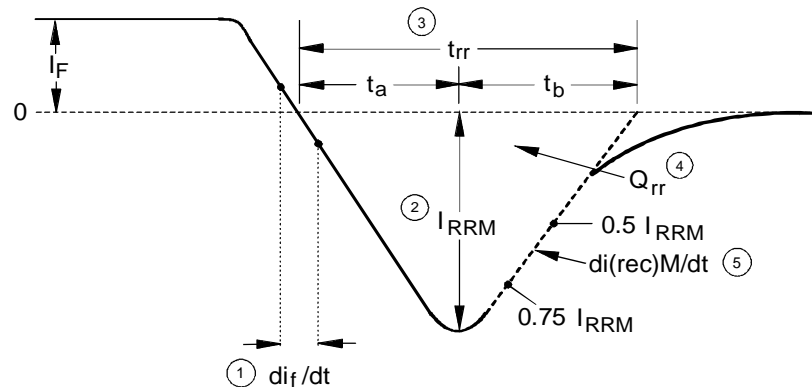

Fig. WF2 - Typ. Turn-on Loss Waveform
@ $T_J = 25^\circ\text{C}$ using Fig. CT.3



1. di_f/dt - Rate of change of current through zero crossing
2. I_{RRM} - Peak reverse recovery current
3. t_{rr} - Reverse recovery time measured from zero crossing point of negative going I_F to point where a line passing through $0.75 I_{RRM}$ and $0.50 I_{RRM}$ extrapolated to zero current

4. Q_{rr} - Area under curve defined by t_{rr} and I_{RRM}
- $$Q_{rr} = \frac{t_{rr} \times I_{RRM}}{2}$$
5. $di_{(rec)M}/dt$ - Peak rate of change of current during t_b portion of t_{rr}

Fig. WF3 - Reverse Recovery Waveform and Definitions

TO-247AC Package Outline

Dimensions are shown in millimeters (inches)

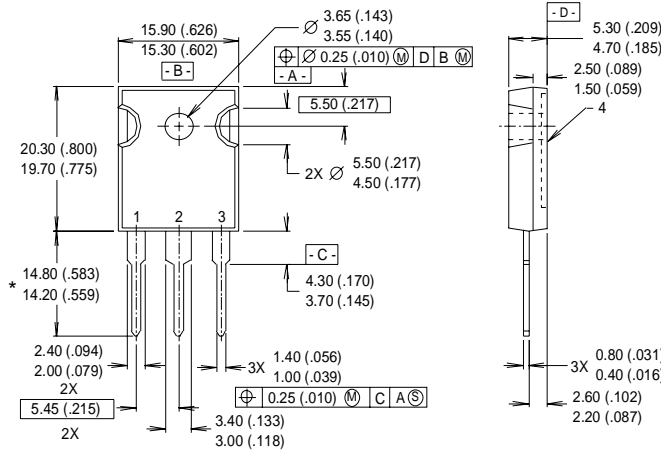

NOTES:

- 1 DIMENSIONS & TOLERANCING PER ANSI Y14.5M, 1982.
- 2 CONTROLLING DIMENSION : INCH.
- 3 DIMENSIONS ARE SHOWN MILLIMETERS (INCHES).
- 4 CONFORMS TO JEDEC OUTLINE TO-247AC.

LEAD ASSIGNMENTS

- 1 - GATE
- 2 - COLLECTOR
- 3 - EMITTER
- 4 - COLLECTOR

* LONGER LEADED (20mm) VERSION AVAILABLE (TO-247AD) TO ORDER ADD "E" SUFFIX TO PART NUMBER

CONFORMS TO JEDEC OUTLINE TO-247AC (TO-3P)

Dimensions in Millimeters and (Inches)

TO-247AC Part Marking Information

Notes: This part marking information applies to devices produced before 02/26/2001 or for parts manufactured in GB.

EXAMPLE: THIS IS AN IRFPE30 WITH ASSEMBLY LOT CODE 3A1Q

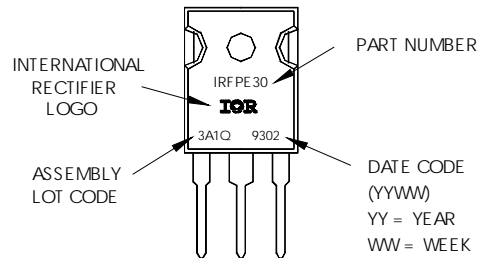

Notes: This part marking information applies to devices produced after 02/26/2001

EXAMPLE: THIS IS AN IRFPE30 WITH ASSEMBLY LOT CODE 5657 ASSEMBLED ON WW 35, 2000 IN THE ASSEMBLY LINE "H"

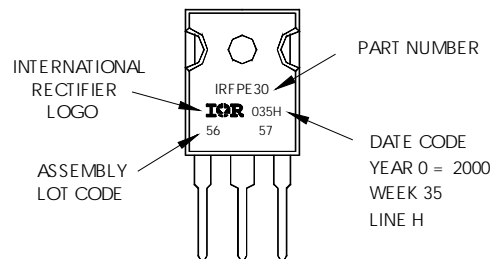

TO-247AC package is not recommended for Surface Mount Application.

Data and specifications subject to change without notice.
This product has been designed and qualified for Industrial market.
Qualification Standards can be found on IR's Web site.