

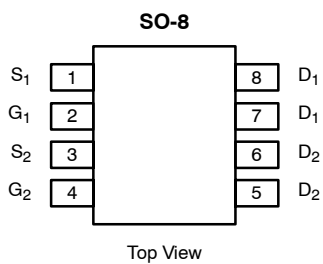

Dual P-Channel 2.5-V (G-S) MOSFET

PRODUCT SUMMARY		
V_{DS} (V)	$r_{DS(on)}$ (Ω)	I_D (A)
-20	0.06 @ $V_{GS} = -4.5$ V	-4.7
	0.10 @ $V_{GS} = -2.5$ V	-3.7



Ordering Information: Si9933BDY—E3 (Lead Free)
Si9933BDY-T1—E3 (Lead Free with Tape and Reel)

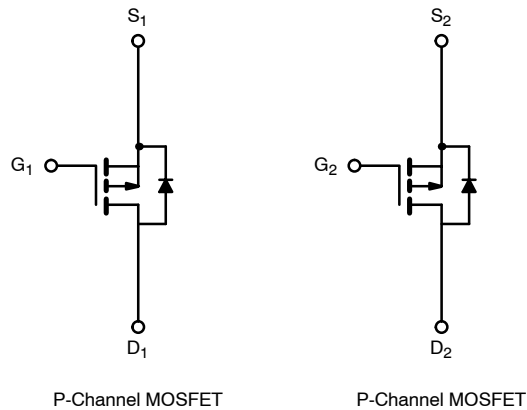

ABSOLUTE MAXIMUM RATINGS ($T_A = 25^\circ\text{C}$ UNLESS OTHERWISE NOTED)					
Parameter	Symbol	10 secs	Steady State	Unit	
Drain-Source Voltage	V_{DS}	-20		V	
Gate-Source Voltage	V_{GS}	± 12			
Continuous Drain Current ($T_J = 150^\circ\text{C}$) ^a	I_D	$T_A = 25^\circ\text{C}$	-4.7	-3.6	A
		$T_A = 70^\circ\text{C}$	-3.8	-2.8	
Pulsed Drain Current	I_{DM}	-20			
continuous Source Current (Diode Conduction) ^a	I_S	-1.7	-0.9		
Maximum Power Dissipation ^a	P_D	$T_A = 25^\circ\text{C}$	2.0	1.1	W
		$T_A = 70^\circ\text{C}$	1.3	0.7	
Operating Junction and Storage Temperature Range	T_J, T_{stg}	-55 to 150		$^\circ\text{C}$	

THERMAL RESISTANCE RATINGS					
Parameter	Symbol	Typical	Maximum	Unit	
Maximum Junction-to-Ambient ^a	R_{thJA}	$t \leq 10$ sec	55	62.5	$^\circ\text{C/W}$
		Steady State	90	110	
Maximum Junction-to-Foot (Drain)	R_{thJF}	33	40		

Notes

a. Surface Mounted on 1" x 1" FR4 Board.

For SPICE model information via the Worldwide Web: <http://www.vishay.com/www/product/spice.htm>

SPECIFICATIONS (T_J = 25 °C UNLESS OTHERWISE NOTED)

Parameter	Symbol	Test Condition	Min	Typ	Max	Unit
Static						
Gate Threshold Voltage	V _{GS(th)}	V _{DS} = V _{GS} , I _D = -250 μA	-0.6		-1.4	V
Gate-Body Leakage	I _{GSS}	V _{DS} = 0 V, V _{GS} = ±12 V			±100	nA
Zero Gate Voltage Drain Current	I _{DSS}	V _{DS} = -20 V, V _{GS} = 0 V			-1	μA
		V _{DS} = -20 V, V _{GS} = 0 V, T _J = 55 °C			-5	
On-State Drain Current ^a	I _{D(on)}	V _{DS} ≤ -5 V, V _{GS} = -4.5 V	-20			A
Drain-Source On-State Resistance ^a	r _{DS(on)}	V _{GS} = -4.5 V, I _D = -4.7 A		0.048	0.06	Ω
		V _{GS} = -2.5 V, I _D = -1 A		0.08	0.10	
Forward Transconductance ^a	g _{fs}	V _{DS} = -10 V, I _D = -4.7 A		11		S
Diode Forward Voltage ^a	V _{SD}	I _S = -1.7 A, V _{GS} = 0 V		-0.75	-1.2	V
Dynamic^b						
Total Gate Charge	Q _g	V _{DS} = -10 V, V _{GS} = -4.5 V, I _D = -4.7 A		6	9	nC
Gate-Source Charge	Q _{gs}			1.4		
Gate-Drain Charge	Q _{gd}			1.9		
Gate Resistance	R _g	f = 1 MHz		9.5		Ω
Turn-On Delay Time	t _{d(on)}	V _{DD} = -10 V, R _L = 10 Ω I _D ≅ -1 A, V _{GEN} = -4.5 V, R _g = 6 Ω		22	35	ns
Rise Time	t _r			35	55	
Turn-Off Delay Time	t _{d(off)}			45	70	
Fall Time	t _f			25	40	
Source-Drain Reverse Recovery Time	t _{rr}	I _F = -1.7 A, di/dt = 100 A/μs		25	50	

Notes

- a. Pulse test; pulse width ≤ 300 μs, duty cycle ≤ 2%.
- b. Guaranteed by design, not subject to production testing.

TYPICAL CHARACTERISTICS (25 °C UNLESS NOTED)

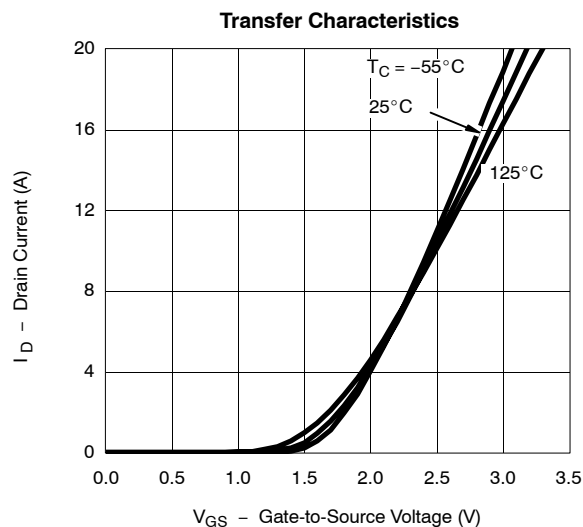
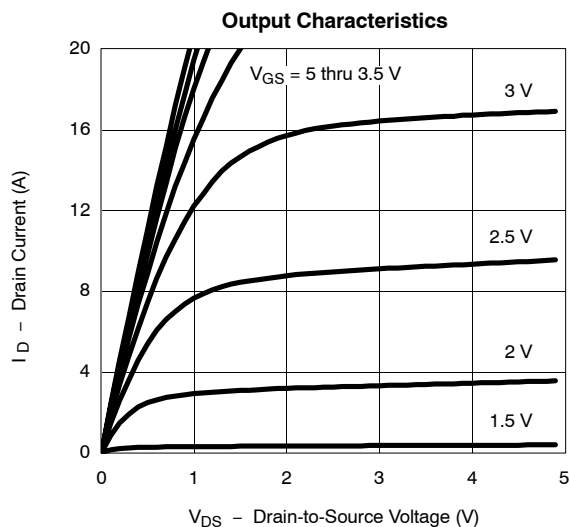



TYPICAL CHARACTERISTICS (25°C UNLESS NOTED)

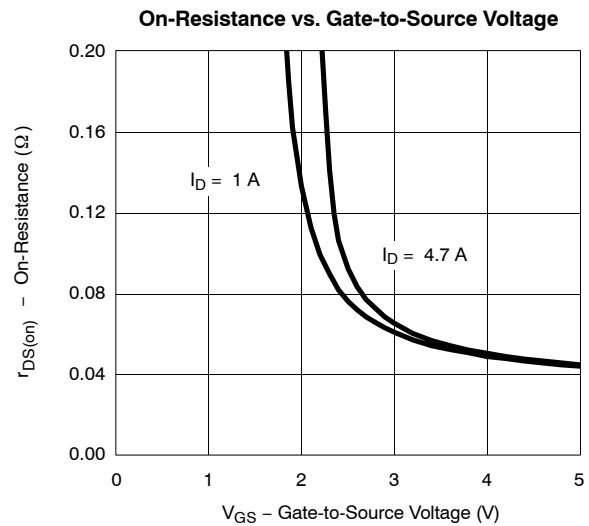
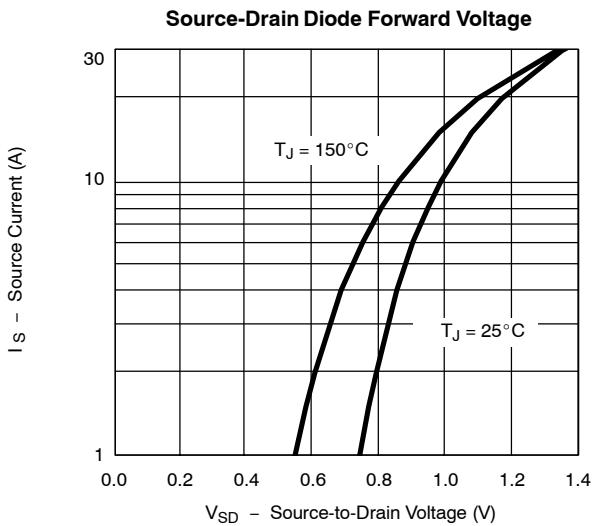
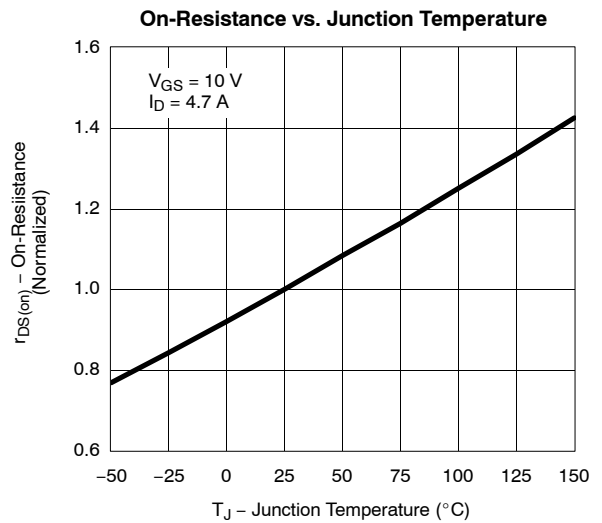
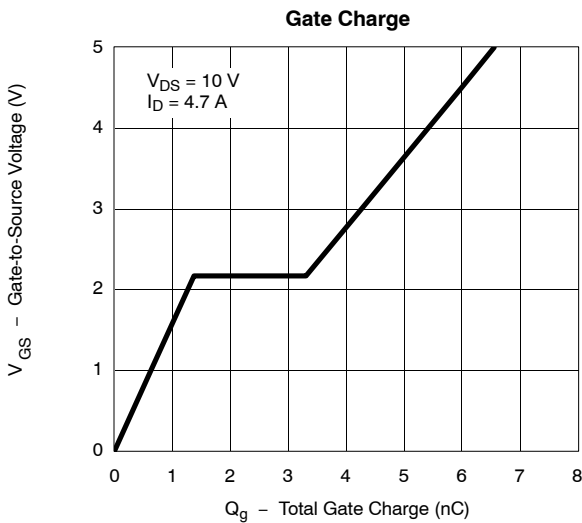
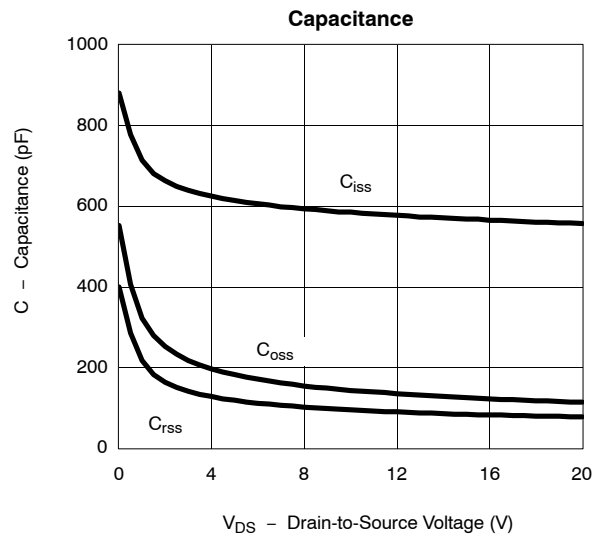
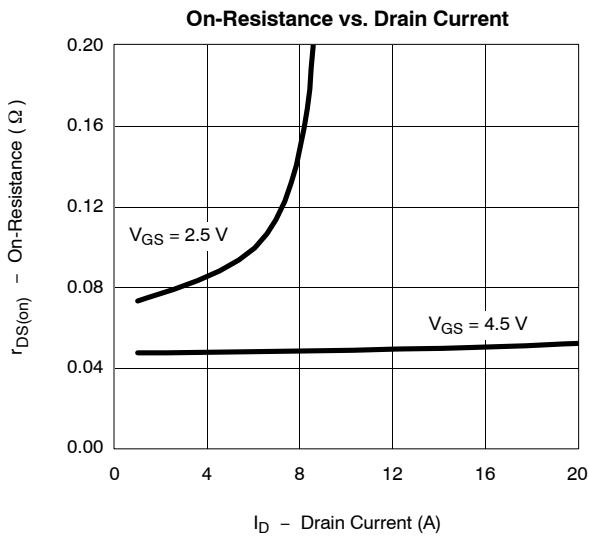

TYPICAL CHARACTERISTICS (25 °C UNLESS NOTED)

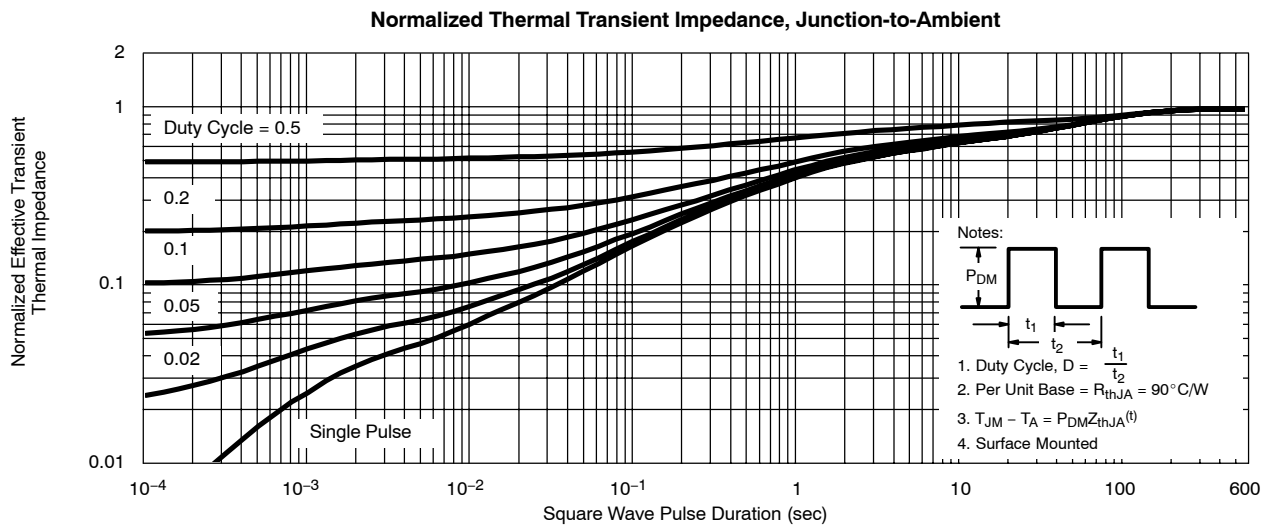
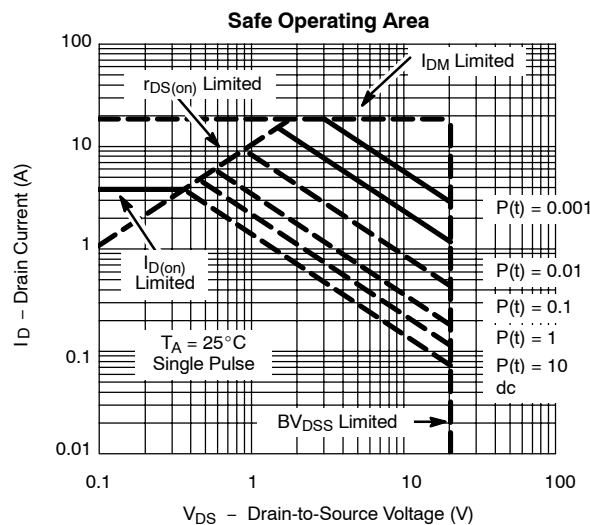
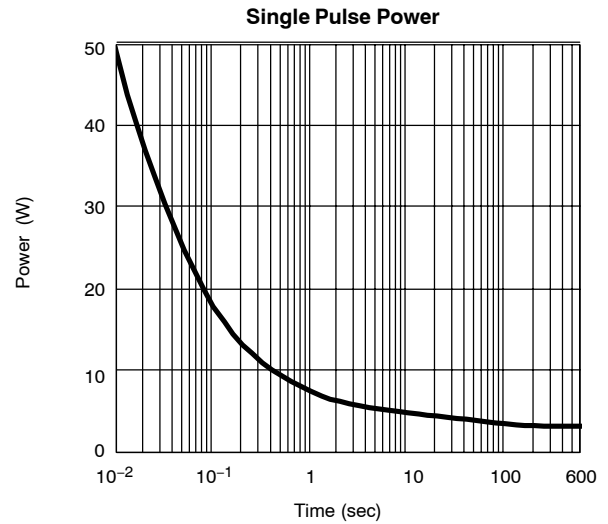
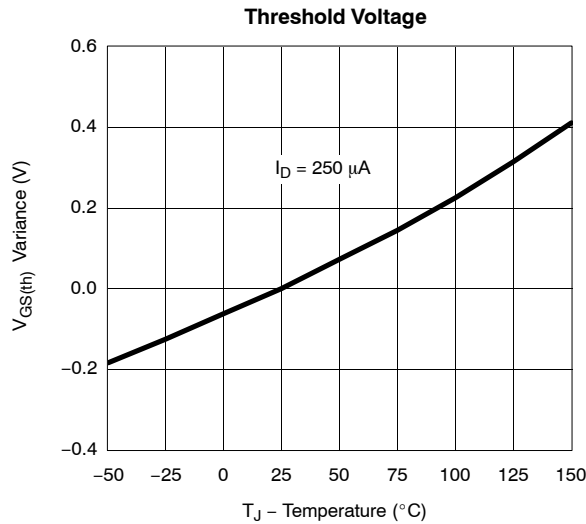



TYPICAL CHARACTERISTICS (25 °C UNLESS NOTED)

