

MC14543B

BCD-to-Seven Segment Latch/Decoder/Driver for Liquid Crystals

The MC14543B BCD-to-seven segment latch/decoder/driver is designed for use with liquid crystal readouts, and is constructed with complementary MOS (CMOS) enhancement mode devices. The circuit provides the functions of a 4-bit storage latch and an 8421 BCD-to-seven segment decoder and driver. The device has the capability to invert the logic levels of the output combination. The phase (Ph), blanking (BI), and latch disable (LD) inputs are used to reverse the truth table phase, blank the display, and store a BCD code, respectively. For liquid crystal (LC) readouts, a square wave is applied to the Ph input of the circuit and the electrically common backplane of the display. The outputs of the circuit are connected directly to the segments of the LC readout. For other types of readouts, such as light-emitting diode (LED), incandescent, gas discharge, and fluorescent readouts, connection diagrams are given on this data sheet.

Applications include instrument (e.g., counter, DVM etc.) display driver, computer/calculator display driver, cockpit display driver, and various clock, watch, and timer uses.

- Latch Storage of Code
- Blanking Input
- Readout Blanking on All Illegal Input Combinations
- Direct LED (Common Anode or Cathode) Driving Capability
- Supply Voltage Range = 3.0 V to 18 V
- Capable of Driving 2 Low-power TTL Loads, 1 Low-power Schottky TTL Load or 2 HTL Loads Over the Rated Temperature Range
- Pin-for-Pin Replacement for CD4056A (with Pin 7 Tied to V_{SS}).
- Chip Complexity: 207 FETs or 52 Equivalent Gates

MAXIMUM RATINGS (Voltages Referenced to V_{SS}) (Note 2.)

Symbol	Parameter	Value	Unit
V_{DD}	DC Supply Voltage Range	-0.5 to +18.0	V
V_{in}	Input Voltage Range, All Inputs	-0.5 to $V_{DD} + 0.5$	V
I_{in}	DC Input Current per Pin	± 10	mA
P_D	Power Dissipation, per Package (Note 3.)	500	mW
T_A	Operating Temperature Range	-55 to +125	$^{\circ}C$
T_{stg}	Storage Temperature Range	-65 to +150	$^{\circ}C$
I_{OHmax} I_{OLmax}	Maximum Continuous Output Drive Current (Source or Sink)	10 (per Output)	mA
P_{OHmax} P_{OLmax}	Maximum Continuous Output Power (Source or Sink) (4.)	70 (per Output)	mW

2. Maximum Ratings are those values beyond which damage to the device may occur.
3. Temperature Derating:
Plastic "P and D/DW" Packages: - 7.0 mW/ $^{\circ}C$ From 65 $^{\circ}C$ To 125 $^{\circ}C$
4. $P_{OHmax} = I_{OH} (V_{OH} - V_{DD})$ and $P_{OLmax} = I_{OL} (V_{OL} - V_{SS})$



ON Semiconductor

<http://onsemi.com>

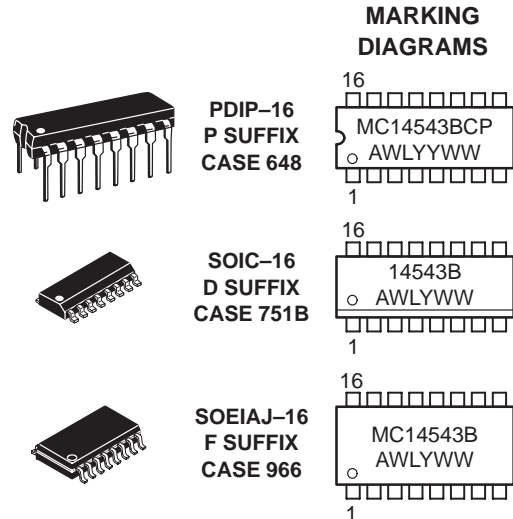

A = Assembly Location
WL or L = Wafer Lot
YY or Y = Year
WW or W = Work Week

ORDERING INFORMATION

Device	Package	Shipping
MC14543BCP	PDIP-16	2000/Box
MC14543BD	SOIC-16	48/Rail
MC14543BDR2	SOIC-16	2500/Tape & Reel
MC14543BF	SOEIAJ-16	See Note 1.
MC14543BFEL	SOEIAJ-16	See Note 1.

1. For ordering information on the EIAJ version of the SOIC packages, please contact your local ON Semiconductor representative.

This device contains protection circuitry to guard against damage due to high static voltages or electric fields. However, precautions must be taken to avoid applications of any voltage higher than maximum rated voltages to this high-impedance circuit. For proper operation, V_{in} and V_{out} should be constrained to the range $V_{SS} \leq (V_{in} \text{ or } V_{out}) \leq V_{DD}$.

Unused inputs must always be tied to an appropriate logic voltage level (e.g., either V_{SS} or V_{DD}). Unused outputs must be left open.

MC14543B

PIN ASSIGNMENT

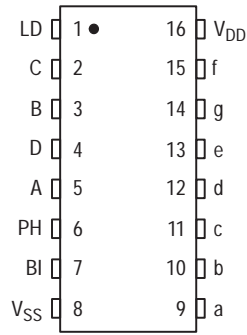

TRUTH TABLE

Inputs							Outputs							
LD	BI	Ph*	D	C	B	A	a	b	c	d	e	f	g	Display
X	1	0	X	X	X	X	0	0	0	0	0	0	0	Blank
1	0	0	0	0	0	0	1	1	1	1	1	1	0	0
1	0	0	0	0	0	1	0	1	1	0	0	0	0	1
1	0	0	0	0	1	0	1	1	0	1	1	0	1	2
1	0	0	0	0	1	1	1	1	1	1	0	0	1	3
1	0	0	0	1	0	0	0	1	1	0	0	1	1	4
1	0	0	0	1	0	1	1	0	1	1	0	1	1	5
1	0	0	0	1	1	0	1	0	1	1	1	1	1	6
1	0	0	0	1	1	1	1	1	1	0	0	0	0	7
1	0	0	1	0	0	0	1	1	1	1	1	1	1	8
1	0	0	1	0	0	1	1	1	1	1	0	1	1	9
1	0	0	1	0	1	0	0	0	0	0	0	0	0	Blank
1	0	0	1	0	1	1	0	0	0	0	0	0	0	Blank
1	0	0	1	1	0	0	0	0	0	0	0	0	0	Blank
1	0	0	1	1	0	1	0	0	0	0	0	0	0	Blank
1	0	0	1	1	1	0	0	0	0	0	0	0	0	Blank
0	0	0	X	X	X	X	**							**
†	†	†	†				Inverse of Output Combinations Above							Display as above

X = Don't care

† = Above Combinations

* = For liquid crystal readouts, apply a square wave to Ph

For common cathode LED readouts, select Ph = 0

For common anode LED readouts, select Ph = 1

** = Depends upon the BCD code previously applied when LD = 1

MC14543B

ELECTRICAL CHARACTERISTICS (Voltages Referenced to V_{SS})

Characteristic	Symbol	V _{DD} Vdc	- 55°C		25°C			125°C		Unit
			Min	Max	Min	Typ ^(5.)	Max	Min	Max	
Output Voltage V _{in} = V _{DD} or 0 V _{in} = 0 or V _{DD}	"0" Level V _{OL}	5.0	—	0.05	—	0	0.05	—	0.05	Vdc
		10	—	0.05	—	0	0.05	—	0.05	
		15	—	0.05	—	0	0.05	—	0.05	
	"1" Level V _{OH}	5.0	4.95	—	4.95	5.0	—	4.95	—	
		10	9.95	—	9.95	10	—	9.95	—	
		15	14.95	—	14.95	15	—	14.95	—	
Input Voltage "0" Level (V _O = 4.5 or 0.5 Vdc) (V _O = 9.0 or 1.0 Vdc) (V _O = 13.5 or 1.5 Vdc) "1" Level (V _O = 0.5 or 4.5 Vdc) (V _O = 1.0 or 9.0 Vdc) (V _O = 1.5 or 13.5 Vdc)	V _{IL}	5.0	—	1.5	—	2.25	1.5	—	1.5	Vdc
		10	—	3.0	—	4.50	3.0	—	3.0	
		15	—	4.0	—	6.75	4.0	—	4.0	
	V _{IH}	5.0	3.5	—	3.5	2.75	—	3.5	—	
		10	7.0	—	7.0	5.50	—	7.0	—	
		15	11	—	11	8.25	—	11	—	
Output Drive Current Source (V _{OH} = 2.5 Vdc) (V _{OH} = 4.6 Vdc) (V _{OH} = 0.5 Vdc) (V _{OH} = 9.5 Vdc) (V _{OH} = 13.5 Vdc) Sink (V _{OL} = 0.4 Vdc) (V _{OL} = 0.5 Vdc) (V _{OL} = 9.5 Vdc) (V _{OL} = 1.5 Vdc)	I _{OH}	5.0	-3.0	—	-2.4	-4.2	—	-1.7	—	mAdc
		5.0	-0.64	—	-0.51	-0.88	—	-0.36	—	
		10	—	—	—	-10.1	—	—	—	
		10	-1.6	—	-1.3	-2.25	—	-0.9	—	
		15	-4.2	—	-3.4	-8.8	—	-2.4	—	
	I _{OL}	5.0	0.64	—	0.51	0.88	—	0.36	—	
		10	1.6	—	1.3	2.25	—	0.9	—	
		10	—	—	—	10.1	—	—	—	
		15	4.2	—	3.4	8.8	—	2.4	—	
		—	—	—	—	—	—	—	—	
Input Current	I _{in}	15	—	±0.1	—	±0.00001	±0.1	—	±1.0	μAdc
Input Capacitance	C _{in}	—	—	—	—	5.0	7.5	—	—	pF
Quiescent Current (Per Package) V _{in} = 0 or V _{DD} , I _{out} = 0 μA	I _{DD}	5.0	—	5.0	—	0.005	5.0	—	150	μAdc
		10	—	10	—	0.010	10	—	300	
		15	—	20	—	0.015	20	—	600	
Total Supply Current ^(6.) ^(7.) (Dynamic plus Quiescent, Per Package) (C _L = 50 pF on all outputs, all buffers switching)	I _T	5.0	I _T = (1.6 μA/kHz) f + I _{DD}							μAdc
		10	I _T = (3.1 μA/kHz) f + I _{DD}							
		15	I _T = (4.7 μA/kHz) f + I _{DD}							

5. Noise immunity specified for worst-case input combination.

Noise Margin for both "1" and "0" level = 1.0 V min @ V_{DD} = 5.0 V
2.0 V min @ V_{DD} = 10 V
2.5 V min @ V_{DD} = 15 V

6. To calculate total supply current at loads other than 50 pF:

$$I_T(C_L) = I_T(50 \text{ pF}) + 3.5 \times 10^{-3} (C_L - 50) V_{DD} f$$

where: I_T is in μA (per package), C_L in pF, V_{DD} in V, and f in kHz is input frequency.

7. The formulas given are for the typical characteristics only at 25°C.

MC14543B

SWITCHING CHARACTERISTICS (8.) ($C_L = 50 \text{ pF}$, $T_A = 25^\circ\text{C}$)

Characteristic	Symbol	V_{DD}	Min	Typ	Max	Unit
Output Rise Time $t_{TLH} = (3.0 \text{ ns/pF}) C_L + 30 \text{ ns}$ $t_{TLH} = (1.5 \text{ ns/pF}) C_L + 15 \text{ ns}$ $t_{TLH} = (1.1 \text{ ns/pF}) C_L + 10 \text{ ns}$	t_{TLH}	5.0 10 15	— — —	100 50 40	200 100 80	ns
Output Fall Time $t_{THL} = (1.5 \text{ ns/pF}) C_L + 25 \text{ ns}$ $t_{THL} = (0.75 \text{ ns/pF}) C_L + 12.5 \text{ ns}$ $t_{THL} = (0.55 \text{ ns/pF}) C_L + 12.5 \text{ ns}$	t_{THL}	5.0 10 15	— — —	100 50 40	200 100 80	ns
Turn-Off Delay Time $t_{PLH} = (1.7 \text{ ns/pF}) C_L + 520 \text{ ns}$ $t_{PLH} = (0.66 \text{ ns/pF}) C_L + 217 \text{ ns}$ $t_{PLH} = (0.5 \text{ ns/pF}) C_L + 160 \text{ ns}$	t_{PLH}	5.0 10 15	— — —	605 250 185	1210 500 370	ns
Turn-On Delay Time $t_{PHL} = (1.7 \text{ ns/pF}) C_L + 420 \text{ ns}$ $t_{PHL} = (0.66 \text{ ns/pF}) C_L + 172 \text{ ns}$ $t_{PHL} = (0.5 \text{ ns/pF}) C_L + 130 \text{ ns}$	t_{PHL}	5.0 10 15	— — —	505 205 155	1650 660 495	ns
Setup Time	t_{su}	5.0 10 15	350 450 500		— — —	ns
Hold Time	t_h	5.0 10 15	40 30 20		— — —	ns
Latch Disable Pulse Width (Strobing Data)	t_{WH}	5.0 10 15	250 100 80	125 50 40	— — —	ns

8. The formulas given are for the typical characteristics only.

LOGIC DIAGRAM

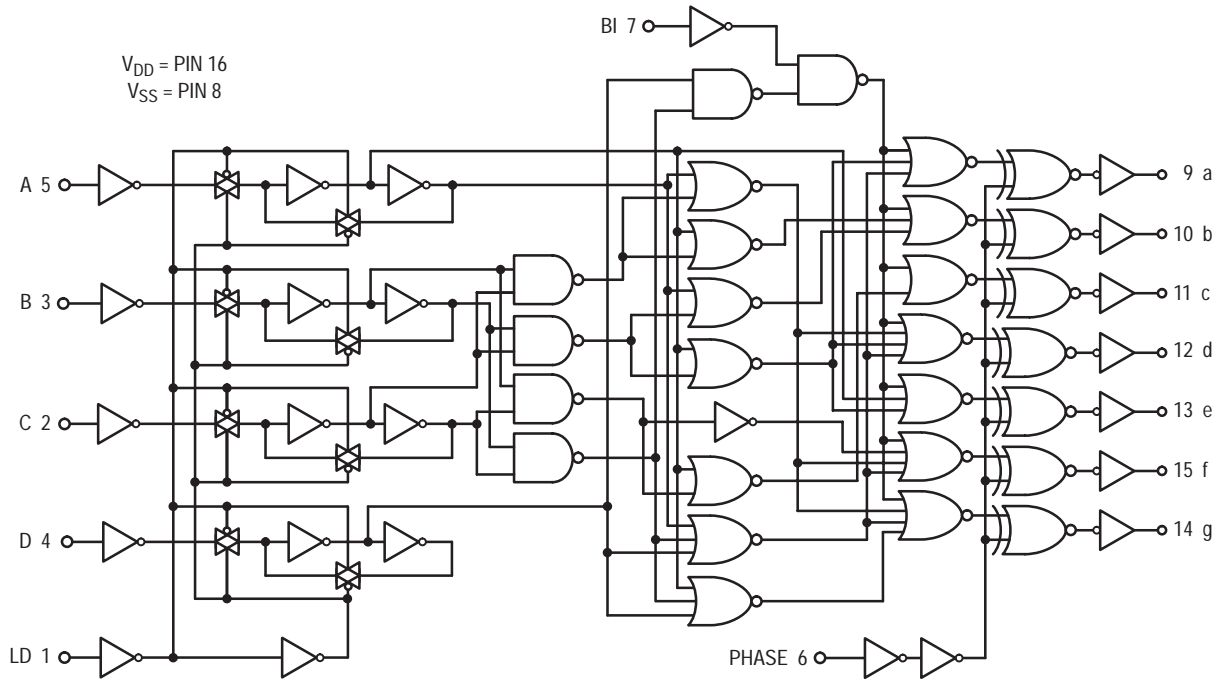

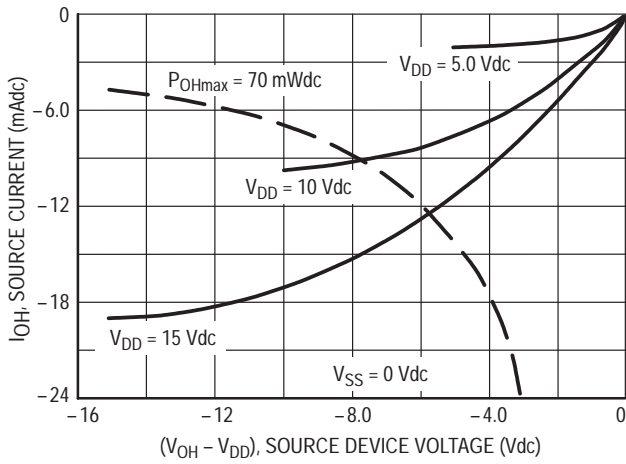

Figure 1. Typical Output Source Characteristics

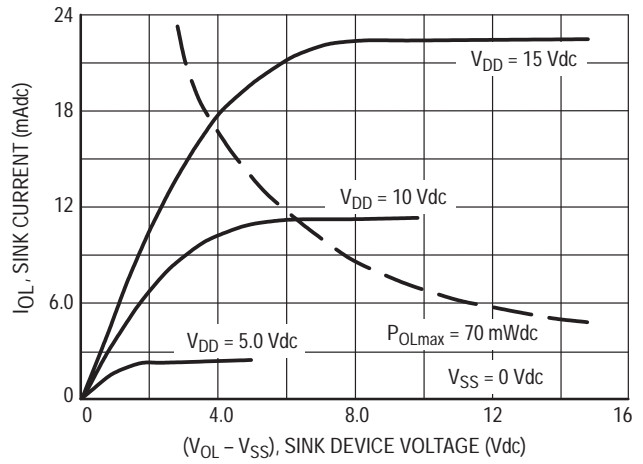

Figure 2. Typical Output Sink Characteristics

Inputs BI and Ph low, and Inputs D and LD high.
f in respect to a system clock.

All outputs connected to respective C_L loads.

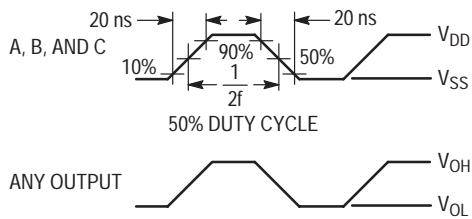
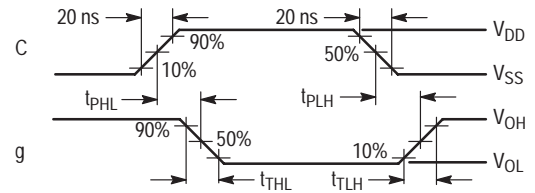
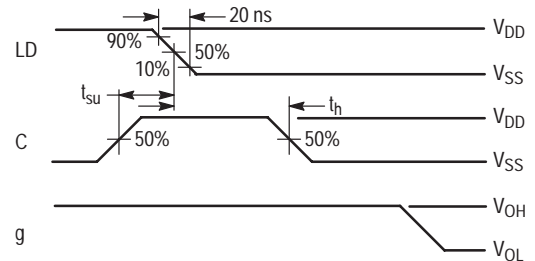

Figure 3. Dynamic Power Dissipation Signal Waveforms

(a) Inputs D, Ph, and BI low, and Inputs A, B, and LD high.



(b) Inputs D, Ph, and BI low, and Inputs A and B high.



(c) Data DCBA strobed into latches

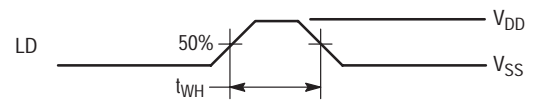
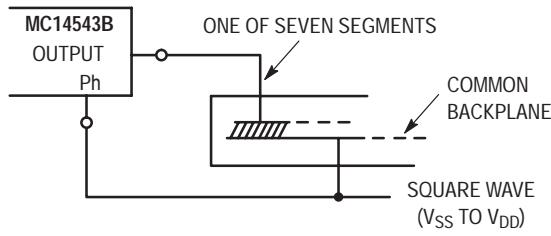

Figure 4. Dynamic Signal Waveforms

MC14543B

CONNECTIONS TO VARIOUS DISPLAY READOUTS

LIQUID CRYSTAL (LC) READOUT



INCANDESCENT READOUT

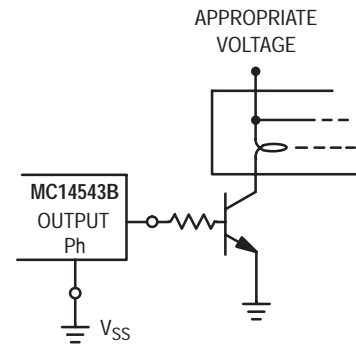

LIGHT EMITTING DIODE (LED) READOUT

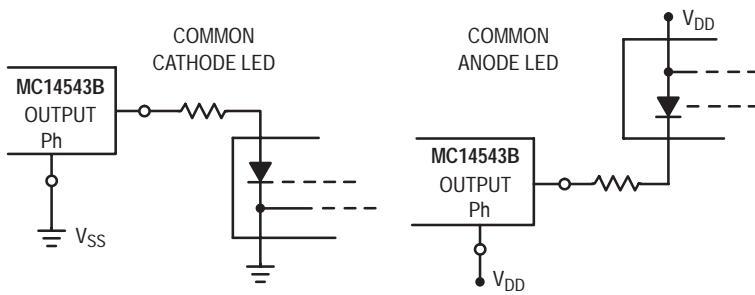

NOTE: Bipolar transistors may be added for gain (for $V_{DD} \leq 10$ V or $I_{out} \geq 10$ mA).

GAS DISCHARGE READOUT

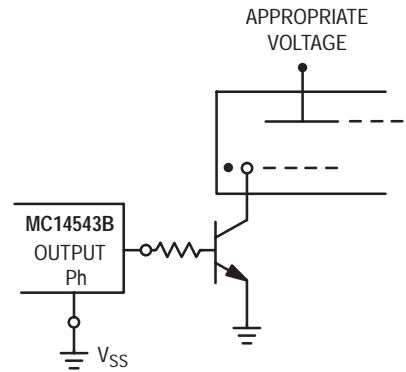

CONNECTIONS TO SEGMENTS

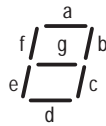

V_{DD} = PIN 16
 V_{SS} = PIN 8

DISPLAY

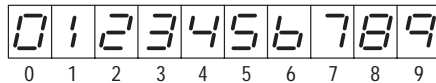

MC14543B

PACKAGE DIMENSIONS

PDIP-16 P SUFFIX PLASTIC DIP PACKAGE CASE 648-08 ISSUE R

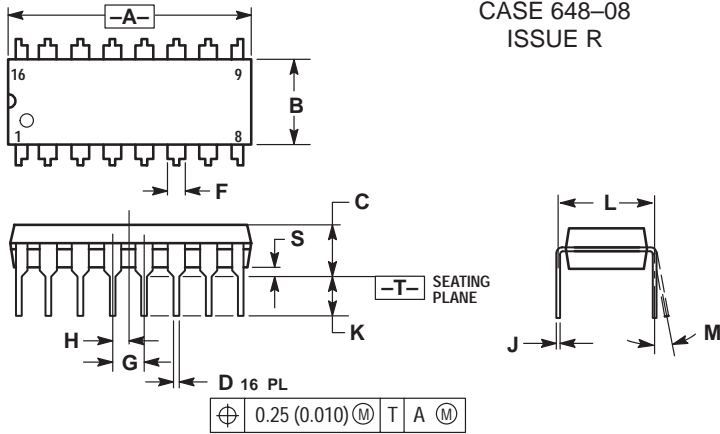

- NOTES:
1. DIMENSIONING AND TOLERANCING PER ANSI Y14.5M, 1982.
 2. CONTROLLING DIMENSION: INCH.
 3. DIMENSION L TO CENTER OF LEADS WHEN FORMED PARALLEL.
 4. DIMENSION B DOES NOT INCLUDE MOLD FLASH.
 5. ROUNDED CORNERS OPTIONAL.

DIM	INCHES		MILLIMETERS	
	MIN	MAX	MIN	MAX
A	0.740	0.770	18.80	19.55
B	0.250	0.270	6.35	6.85
C	0.145	0.175	3.69	4.44
D	0.015	0.021	0.39	0.53
F	0.040	0.70	1.02	1.77
G	0.100 BSC		2.54 BSC	
H	0.050 BSC		1.27 BSC	
J	0.008	0.015	0.21	0.38
K	0.110	0.130	2.80	3.30
L	0.295	0.305	7.50	7.74
M	0°	10°	0°	10°
S	0.020	0.040	0.51	1.01

SOIC-16 D SUFFIX PLASTIC SOIC PACKAGE CASE 751B-05 ISSUE J

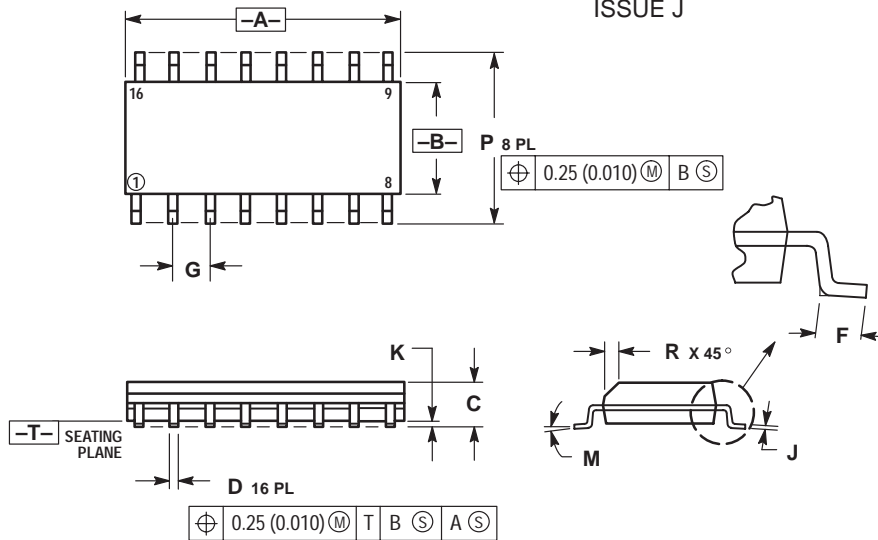

- NOTES:
1. DIMENSIONING AND TOLERANCING PER ANSI Y14.5M, 1982.
 2. CONTROLLING DIMENSION: MILLIMETER.
 3. DIMENSIONS A AND B DO NOT INCLUDE MOLD PROTRUSION.
 4. MAXIMUM MOLD PROTRUSION 0.15 (0.006) PER SIDE.
 5. DIMENSION D DOES NOT INCLUDE DAMBAR PROTRUSION. ALLOWABLE DAMBAR PROTRUSION SHALL BE 0.127 (0.005) TOTAL IN EXCESS OF THE D DIMENSION AT MAXIMUM MATERIAL CONDITION.

DIM	MILLIMETERS		INCHES	
	MIN	MAX	MIN	MAX
A	9.80	10.00	0.386	0.393
B	3.80	4.00	0.150	0.157
C	1.35	1.75	0.054	0.068
D	0.35	0.49	0.014	0.019
F	0.40	1.25	0.016	0.049
G	1.27 BSC		0.050 BSC	
J	0.19	0.25	0.008	0.009
K	0.10	0.25	0.004	0.009
M	0°	7°	0°	7°
P	5.80	6.20	0.229	0.244
R	0.25	0.50	0.010	0.019

MC14543B

PACKAGE DIMENSIONS

SOEIAJ-16 F SUFFIX PLASTIC EIAJ SOIC PACKAGE CASE 966-01 ISSUE O

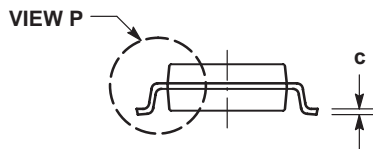
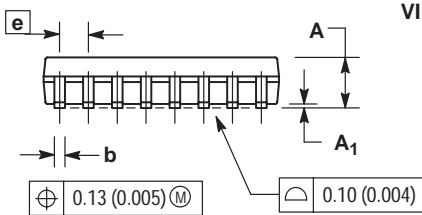
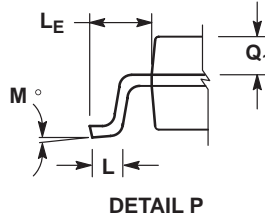
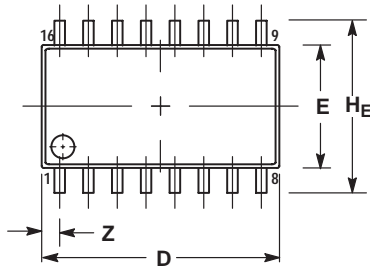

NOTES:

1. DIMENSIONING AND TOLERANCING PER ANSI Y14.5M, 1982.
2. CONTROLLING DIMENSION: MILLIMETER.
3. DIMENSIONS D AND E DO NOT INCLUDE MOLD FLASH OR PROTRUSIONS AND ARE MEASURED AT THE PARTING LINE. MOLD FLASH OR PROTRUSIONS SHALL NOT EXCEED 0.15 (0.006) PER SIDE.
4. TERMINAL NUMBERS ARE SHOWN FOR REFERENCE ONLY.
5. THE LEAD WIDTH DIMENSION (b) DOES NOT INCLUDE DAMBAR PROTRUSION. ALLOWABLE DAMBAR PROTRUSION SHALL BE 0.08 (0.003) TOTAL IN EXCESS OF THE LEAD WIDTH DIMENSION AT MAXIMUM MATERIAL CONDITION. DAMBAR CANNOT BE LOCATED ON THE LOWER RADIUS OR THE FOOT. MINIMUM SPACE BETWEEN PROTRUSIONS AND ADJACENT LEAD TO BE 0.46 (0.018).

DIM	MILLIMETERS		INCHES	
	MIN	MAX	MIN	MAX
A	---	2.05	---	0.081
A ₁	0.05	0.20	0.002	0.008
b	0.35	0.50	0.014	0.020
c	0.18	0.27	0.007	0.011
D	9.90	10.50	0.390	0.413
E	5.10	5.45	0.201	0.215
e	1.27 BSC		0.050 BSC	
H _E	7.40	8.20	0.291	0.323
L	0.50	0.85	0.020	0.033
L _F	1.10	1.50	0.043	0.059
M	0°	10°	0°	10°
Q ₁	0.70	0.90	0.028	0.035
Z	---	0.78	---	0.031

ON Semiconductor and  are trademarks of Semiconductor Components Industries, LLC (SCILLC). SCILLC reserves the right to make changes without further notice to any products herein. SCILLC makes no warranty, representation or guarantee regarding the suitability of its products for any particular purpose, nor does SCILLC assume any liability arising out of the application or use of any product or circuit, and specifically disclaims any and all liability, including without limitation special, consequential or incidental damages. "Typical" parameters which may be provided in SCILLC data sheets and/or specifications can and do vary in different applications and actual performance may vary over time. All operating parameters, including "Typicals" must be validated for each customer application by customer's technical experts. SCILLC does not convey any license under its patent rights nor the rights of others. SCILLC products are not designed, intended, or authorized for use as components in systems intended for surgical implant into the body, or other applications intended to support or sustain life, or for any other application in which the failure of the SCILLC product could create a situation where personal injury or death may occur. Should Buyer purchase or use SCILLC products for any such unintended or unauthorized application, Buyer shall indemnify and hold SCILLC and its officers, employees, subsidiaries, affiliates, and distributors harmless against all claims, costs, damages, and expenses, and reasonable attorney fees arising out of, directly or indirectly, any claim of personal injury or death associated with such unintended or unauthorized use, even if such claim alleges that SCILLC was negligent regarding the design or manufacture of the part. SCILLC is an Equal Opportunity/Affirmative Action Employer.

PUBLICATION ORDERING INFORMATION

NORTH AMERICA Literature Fulfillment:

Literature Distribution Center for ON Semiconductor
P.O. Box 5163, Denver, Colorado 80217 USA
Phone: 303-675-2175 or 800-344-3860 Toll Free USA/Canada
Fax: 303-675-2176 or 800-344-3867 Toll Free USA/Canada
Email: ONlit@hibbertco.com
Fax Response Line: 303-675-2167 or 800-344-3810 Toll Free USA/Canada

N. American Technical Support: 800-282-9855 Toll Free USA/Canada

EUROPE: LDC for ON Semiconductor – European Support

German Phone: (+1) 303-308-7140 (M-F 1:00pm to 5:00pm Munich Time)
Email: ONlit-german@hibbertco.com
French Phone: (+1) 303-308-7141 (M-F 1:00pm to 5:00pm Toulouse Time)
Email: ONlit-french@hibbertco.com
English Phone: (+1) 303-308-7142 (M-F 12:00pm to 5:00pm UK Time)
Email: ONlit@hibbertco.com

EUROPEAN TOLL-FREE ACCESS*: 00-800-4422-3781

*Available from Germany, France, Italy, England, Ireland

CENTRAL/SOUTH AMERICA:

Spanish Phone: 303-308-7143 (Mon-Fri 8:00am to 5:00pm MST)
Email: ONlit-spanish@hibbertco.com

ASIA/PACIFIC: LDC for ON Semiconductor – Asia Support

Phone: 303-675-2121 (Tue-Fri 9:00am to 1:00pm, Hong Kong Time)
Toll Free from Hong Kong & Singapore:
001-800-4422-3781
Email: ONlit-asia@hibbertco.com

JAPAN: ON Semiconductor, Japan Customer Focus Center

4-32-1 Nishi-Gotanda, Shinagawa-ku, Tokyo, Japan 141-8549
Phone: 81-3-5740-2745
Email: r14525@onsemi.com

ON Semiconductor Website: <http://onsemi.com>

For additional information, please contact your local Sales Representative.