



GaAs INTEGRATED CIRCUIT

UPG2311T5F

GaAs MMIC LOW NOISE AMPLIFIER FOR GPS

DESCRIPTION

The μ PG2311T5F is a GaAs MMIC LNA for Car Navigation Systems and Handy GPS. This IC consists of two stage amplifiers and has high gain performance.

FEATURES

- High gain : $G_P = 37$ dB TYP.
- Low noise : $NF = 1.2$ dB TYP.
- 12-pin plastic QFN package (3.0 × 3.0 × 0.75 mm)

APPLICATION

- Car Navigation System
- Handy GPS

★ ORDERING INFORMATION (Pb-Free)

Part Number	Order Number	Package	Marking	Supplying Form
μ PG2311T5F-E2-A	μ PG2311T5F-E2-A	12-pin plastic QFN (Pb-Free)	2311	<ul style="list-style-type: none">• Embossed tape 8 mm wide• Pin 1 indicates roll-in direction of tape• Qty 3 kpcs/reel

Remark To order evaluation samples, contact your nearby sales office.

Part number for sample order: UPG2311T5F-A

Caution Observe precautions when handling because these devices are sensitive to electrostatic discharge.

The information in this document is subject to change without notice. Before using this document, please confirm that this is the latest version.

★ PIN CONNECTIONS

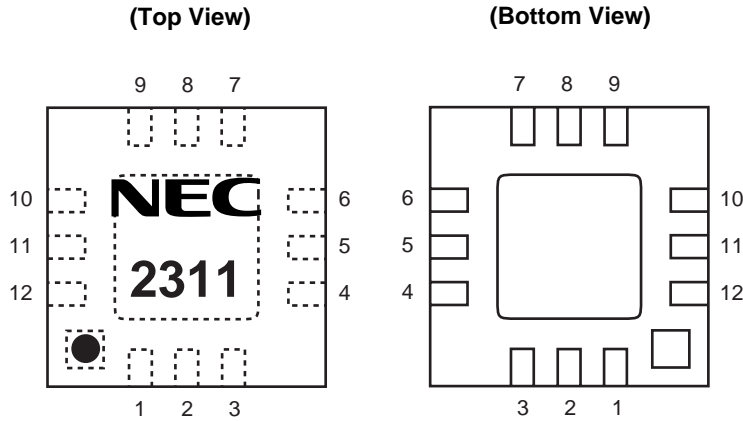

Pin No.	Pin Name
1	OUT2
2	GND
3	V _{cc} 2
4	V _{cc} 1
5	GND
6	IN1
7	GND
8	OUT1
9	GND
10	IN2
11	GND
12	GND
EXPOSED PAD	GND

ABSOLUTE MAXIMUM RATINGS (T_A = +25°C, unless otherwise specified)

Parameter	Symbol	Ratings	Unit
Supply Voltage	V _{cc} 1, V _{cc} 2	+5.0	V
Input Power	P _{in}	-25	dBm
Total Power Dissipation	P _{tot}	0.25 ^{Note}	W
Operating Ambient Temperature	T _A	-45 to +85	°C
Storage Temperature	T _{stg}	-55 to +150	°C

Note Mounted on double-sided copper-clad 50 × 50 × 1.6 mm epoxy glass PWB, T_A = +85°C

RECOMMENDED OPERATING RANGE

Parameter	Symbol	MIN.	TYP.	MAX.	Unit
Operating Frequency	f _{opt}	-	1.575	-	GHz
Supply Voltage	V _{cc} 1, V _{cc} 2	+2.7	+3.0	+3.3	V

ELECTRICAL CHARACTERISTICS ($T_A = +25^\circ\text{C}$, $V_{cc1} = V_{cc2} = +3.0\text{ V}$, $Z_o = 50\ \Omega$, unless otherwise specified)

Parameter	Symbol	Test Conditions	MIN.	TYP.	MAX.	Unit
Power Gain ^{Note 1}	G_P	$f = 1.575\text{ GHz}$	34	37	–	dB
Noise Figure ^{Note 2}	NF	$f = 1.575\text{ GHz}$	–	1.2	1.5	dB
Input Return Loss	RL_{in}	$f = 1.575\text{ GHz}$	–	5	–	dB
★ Output Return Loss	RL_{out}	$f = 1.575\text{ GHz}$	–	20	–	dB
1 dB Gain Compression Output Power	$P_{O(1\text{ dB})}$	$f = 1.575\text{ GHz}$	–	+5	–	dBm
Circuit Current ^{Note 3}	I_{cc}	$f = 1.575\text{ GHz, Non-RF}$	–	17	20	mA

- Notes**
1. Total gain of 1st stage and 2nd stage amplifiers (not include filter loss).
 2. NF of 1st stage amplifier.
 3. Please refer to following chart.

CIRCUIT CURRENT vs. SUPPLY VOLTAGE

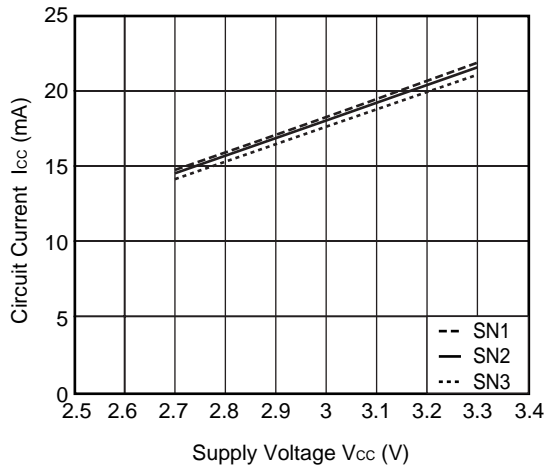

Remark The graph indicates nominal characteristics.

★ TEST CIRCUIT

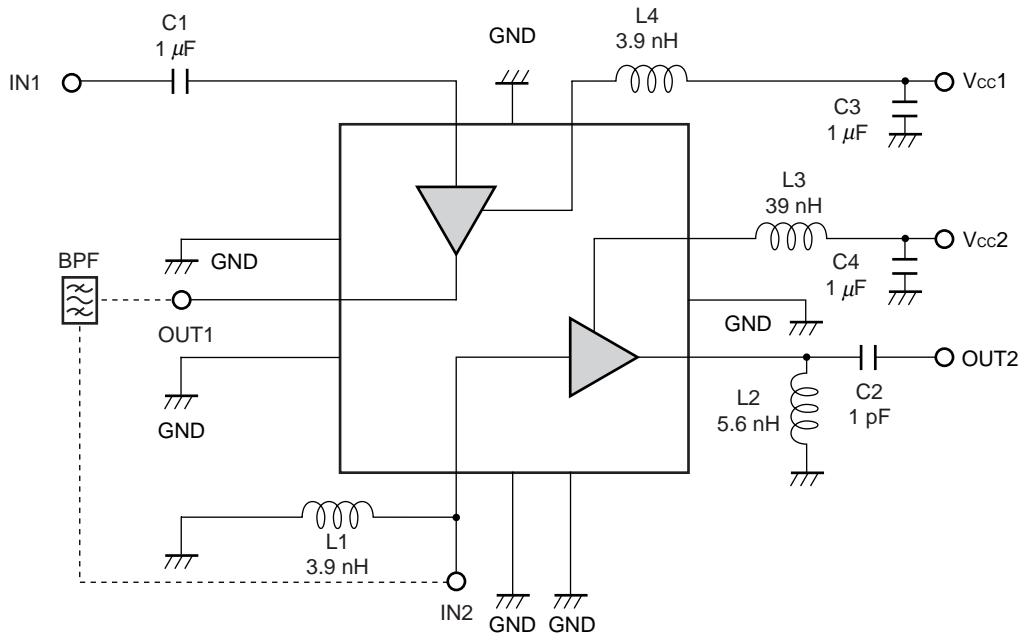

The application circuits and their parameters are for reference only and are not intended for use in actual design-ins.

★ ILLUSTRATION OF THE TEST CIRCUIT ASSEMBLED ON EVALUATION BOARD

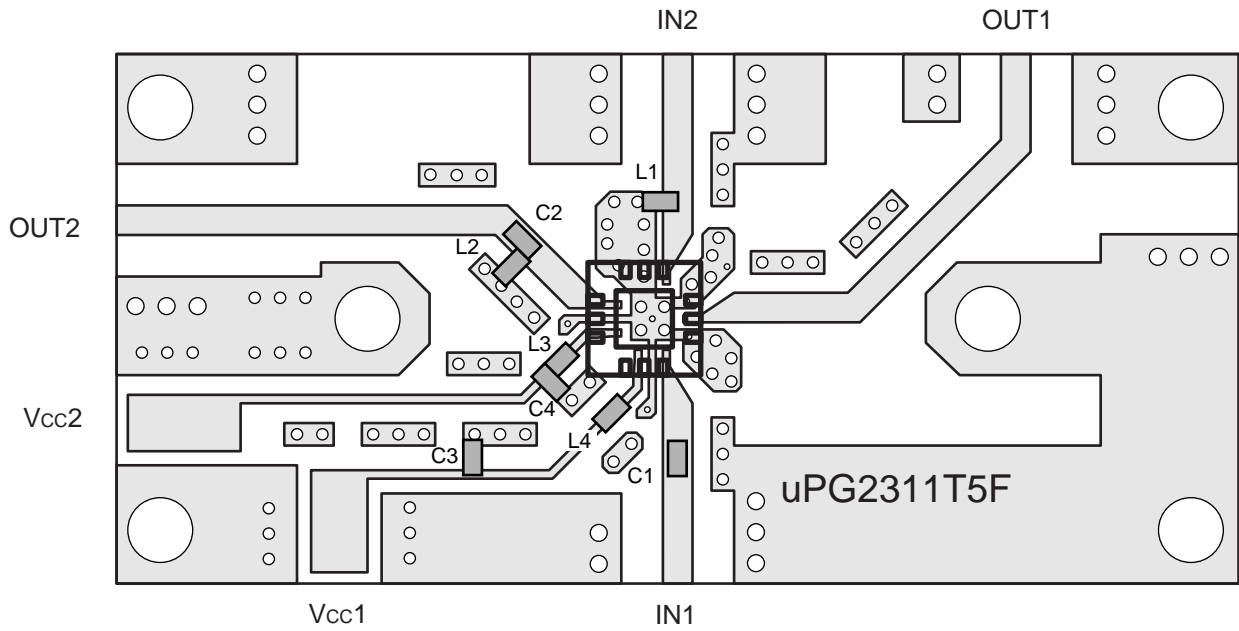

★ USING THE NEC EVALUATION BOARD

Symbol	Rating	Size	Symbol	Rating	Size
C1	1 μ F	1608	L1	3.9 nH	1005
C2	1 pF	1005	L2	5.6 nH	1005
C3	1 μ F	1608	L3	39 nH	1005
C4	1 μ F	1608	L4	3.9 nH	1005

★ PACKAGE DIMENSIONS

12-PIN PLASTIC QFN (UNIT: mm)

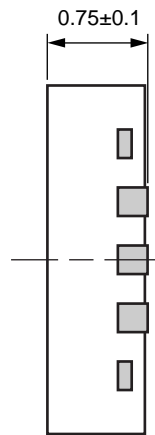
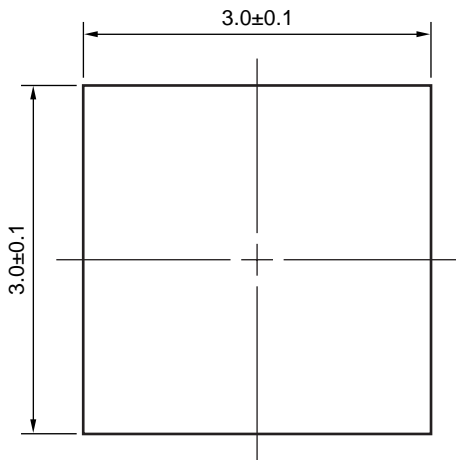

(Bottom View)

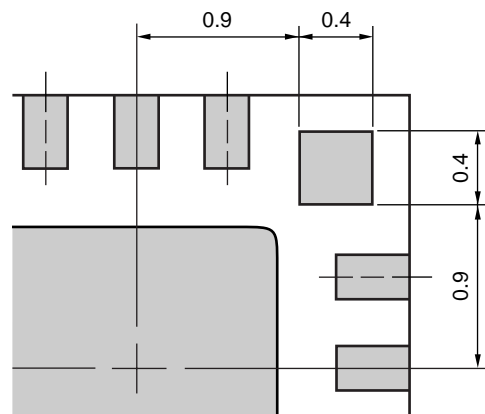
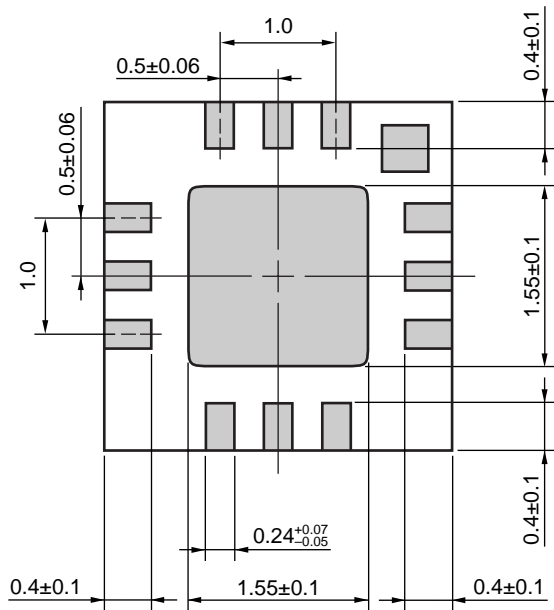

Dimensions of pin No.1 indication

RECOMMENDED SOLDERING CONDITIONS

This product should be soldered and mounted under the following recommended conditions. For soldering methods and conditions other than those recommended below, contact your nearby sales office.

Soldering Method	Soldering Conditions	Condition Symbol
Infrared Reflow	Peak temperature (package surface temperature) : 260°C or below Time at peak temperature : 10 seconds or less Time at temperature of 220°C or higher : 60 seconds or less Preheating time at 120 to 180°C : 120±30 seconds Maximum number of reflow processes : 3 times Maximum chlorine content of rosin flux (% mass) : 0.2%(Wt.) or below	IR260
Wave Soldering	Peak temperature (molten solder temperature) : 260°C or below Time at peak temperature : 10 seconds or less Preheating temperature (package surface temperature) : 120°C or below Maximum number of flow processes : 1 time Maximum chlorine content of rosin flux (% mass) : 0.2%(Wt.) or below	WS260
Partial Heating	Peak temperature (terminal temperature) : 350°C or below Soldering time (per side of device) : 3 seconds or less Maximum chlorine content of rosin flux (% mass) : 0.2%(Wt.) or below	HS350

Caution Do not use different soldering methods together (except for partial heating).

Subject: Compliance with EU Directives

CEL certifies, to its knowledge, that semiconductor and laser products detailed below are compliant with the requirements of European Union (EU) Directive 2002/95/EC Restriction on Use of Hazardous Substances in electrical and electronic equipment (RoHS) and the requirements of EU Directive 2003/11/EC Restriction on Penta and Octa BDE.

CEL Pb-free products have the same base part number with a suffix added. The suffix –A indicates that the device is Pb-free. The –AZ suffix is used to designate devices containing Pb which are exempted from the requirement of RoHS directive (*). In all cases the devices have Pb-free terminals. All devices with these suffixes meet the requirements of the RoHS directive.

This status is based on CEL’s understanding of the EU Directives and knowledge of the materials that go into its products as of the date of disclosure of this information.

Restricted Substance per RoHS	Concentration Limit per RoHS (values are not yet fixed)	Concentration contained in CEL devices	
		-A	-AZ
Lead (Pb)	< 1000 PPM	Not Detected	(*)
Mercury	< 1000 PPM	Not Detected	
Cadmium	< 100 PPM	Not Detected	
Hexavalent Chromium	< 1000 PPM	Not Detected	
PBB	< 1000 PPM	Not Detected	
PBDE	< 1000 PPM	Not Detected	

If you should have any additional questions regarding our devices and compliance to environmental standards, please do not hesitate to contact your local representative.

Important Information and Disclaimer: Information provided by CEL on its website or in other communications concerning the substance content of its products represents knowledge and belief as of the date that it is provided. CEL bases its knowledge and belief on information provided by third parties and makes no representation or warranty as to the accuracy of such information. Efforts are underway to better integrate information from third parties. CEL has taken and continues to take reasonable steps to provide representative and accurate information but may not have conducted destructive testing or chemical analysis on incoming materials and chemicals. CEL and CEL suppliers consider certain information to be proprietary, and thus CAS numbers and other limited information may not be available for release.

In no event shall CEL’s liability arising out of such information exceed the total purchase price of the CEL part(s) at issue sold by CEL to customer on an annual basis.

See CEL Terms and Conditions for additional clarification of warranties and liability.