



## ULTRALOW-NOISE, HIGH PSRR, FAST RF 1.5 A LOW-DROPOUT LINEAR REGULATORS

### FEATURES

- 1.5 A Low-Dropout Regulator With EN
- Available in 1.8-V, 2.5-V, 2.8-V, 3-V, 3.3-V, and Adjustable
- High PSRR (49 dB at 10 kHz)
- Ultralow Noise (48  $\mu\text{V}$ )
- Fast Start-Up Time (50  $\mu\text{s}$ )
- Stable With a 1- $\mu\text{F}$  Ceramic Capacitor
- Excellent Load/Line Transient
- Very Low Dropout Voltage (390 mV at Full Load, TPS78630)
- 5-Pin SOT223-5 and 5-Pin DDPACK Package

### APPLICATIONS

- Powering Noise-Sensitive Circuitry
  - RF
  - Audio
  - VCOs
- DSP/FPGA/Microprocessor Supplies
- Post Regulator for Switching Supplies

### DESCRIPTION

The TPS786xx family of low-dropout (LDO) low-power linear voltage regulators features high power supply rejection ratio (PSRR), ultralow noise, fast start-up, and excellent line and load transient responses in small outline, SOT223-5 and 5-pin DDPACK packages. Each device in the family is stable, with a small 1- $\mu\text{F}$  ceramic capacitor on the output. The family uses an advanced, proprietary BiCMOS fabrication process to yield extremely low dropout voltages (e.g., 390 mV at 1.5 A). Each device achieves fast start-up times (approximately 50  $\mu\text{s}$  with a 0.001  $\mu\text{F}$  bypass capacitor) while consuming very low quiescent current (265  $\mu\text{A}$  typical). Moreover, when the device is placed in standby mode, the supply current is reduced to less than 1  $\mu\text{A}$ . The TPS78630 exhibits approximately 48  $\mu\text{V}_{\text{RMS}}$  of output voltage noise with a 0.1  $\mu\text{F}$  bypass capacitor. Applications with analog components that are noise sensitive, such as portable RF electronics, benefit from the high PSRR, low noise features, and the fast response time.

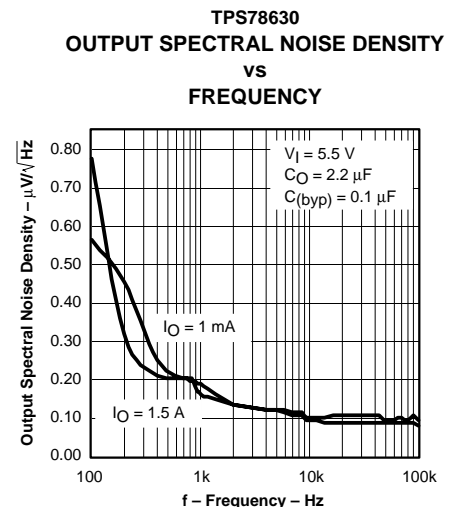
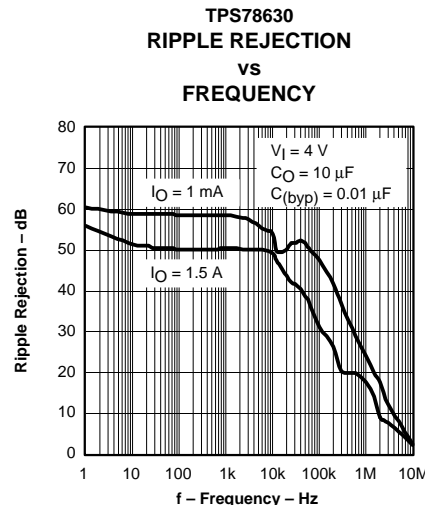
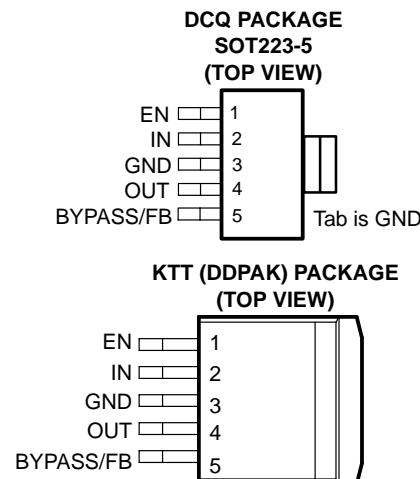

Please be aware that an important notice concerning availability, standard warranty, and use in critical applications of Texas Instruments semiconductor products and disclaimers thereto appears at the end of this data sheet.

**TPS78601, TPS78618, TPS78625  
TPS78628, TPS78630, TPS78633**

SLVS389A – SEPTEMBER 2002 – REVISED FEBRUARY 2003

**AVAILABLE OPTIONS**

T <sub>J</sub>	VOLTAGE	PACKAGE	PART NUMBER	SYMBOL
-40°C to 125°C	1.2 to 5.5 V	SOT223-5	TPS78601DCQ†	PS78601
		DDPAK	TPS78601KTT†	TPS78601
	1.8 V	SOT223-5	TPS78618DCQ†	PS78618
		DDPAK	TPS78618KTT†	TPS78618
	2.5 V	SOT223-5	TPS78625DCQ†	PS78625
		DDPAK	TPS78625KTT†	TPS78625
	2.8 V	SOT223-5	TPS78628DCQ†	PS78628
		DDPAK	TPS78628KTT†	TPS78628
	3 V	SOT223-5	TPS78630DCQ†	PS78630
		DDPAK	TPS78630KTT†	TPS78630
	3.3 V	SOT223-5	TPS78633DCQ†	PS78633
		DDPAK	TPS78633KTT†	TPS78633

† Add R for DCQ devices in tape and reel (quantity =2500). Add T for KTT devices in tape and reel (quantity = 500).

**absolute maximum ratings over operating free-air temperature (unless otherwise noted)‡**

Input voltage range (see Note 1)	-0.3 V to 6 V
Voltage range at EN	-0.3 V to V <sub>I</sub> + 0.3 V
Voltage on OUT	6 V
Peak output current	Internally limited
ESD rating, HBM	2 kV
ESD rating, CDM	500 V
Continuous total power dissipation	See Dissipation Rating table
Operating virtual junction temperature range, T <sub>J</sub>	-40°C to 150°C
Storage temperature range, T <sub>stg</sub>	-65°C to 150°C

‡ Stresses beyond those listed under “absolute maximum ratings” may cause permanent damage to the device. These are stress ratings only, and functional operation of the device at these or any other conditions beyond those indicated under “recommended operating conditions” is not implied. Exposure to absolute-maximum-rated conditions for extended periods may affect device reliability.

NOTE 1: All voltage values are with respect to network ground terminal.

**package dissipation ratings**

PACKAGE	BOARD	R <sub>θJC</sub>	R <sub>θJA</sub>
DDPAK	High K (see Note 2)	2 °C/W	23 °C/W
SOT223	Low K (see Note 3)	15 °C/W	53 °C/W

- NOTES: 2. The JEDEC high K (2s2p) board design used to derive this data was a 3-inch x 3-inch (7,5-cm x 7,5-cm), multilayer board with 1 ounce internal power and ground planes and 2 ounce copper traces on top and bottom of the board.  
3. The JEDEC low K (1s) board design used to derive this data was a 3-inch x 3-inch (7,5-cm x 7,5-cm), two-layer board with 2 ounce copper traces on top of the board.

electrical characteristics over recommended operating free-air temperature range  $EN = V_I$ ,  
 $T_J = -40$  to  $125$  °C,  $V_I = V_O(\text{typ}) + 1$  V,  $I_O = 1$  mA,  $C_O = 10$  μF,  $C(\text{byp}) = 0.01$  μF (unless otherwise noted)

PARAMETER		TEST CONDITIONS		MIN	TYP	MAX	UNIT
$V_I$	Input voltage (see Note 4)			2.7		5.5	V
$I_O$	Continuous output current $I_O$ (see Note 5)			0		1.5	A
$T_J$	Operating junction temperature			-40		125	°C
Output voltage	TPS78601	$T_J = 25^\circ\text{C}$ ,		$V_O$			V
		$0 \mu\text{A} < I_O < 1.5$ A, (see Note 6)	$1.22 \text{ V} \leq V_O \leq 5.5 \text{ V}$	$0.98 V_O$	$1.02 V_O$		
	TPS78618	$T_J = 25^\circ\text{C}$ ,		1.8			V
		$0 \mu\text{A} < I_O < 1.5$ A,	$2.8 \text{ V} < V_I < 5.5 \text{ V}$	1.764	1.836		
	TPS78625	$T_J = 25^\circ\text{C}$ ,		2.5			V
		$0 \mu\text{A} < I_O < 1.5$ A,	$3.5 \text{ V} < V_I < 5.5 \text{ V}$	2.45	2.55		
	TPS78628	$T_J = 25^\circ\text{C}$ ,		2.8			V
		$0 \mu\text{A} < I_O < 1.5$ A,	$3.8 \text{ V} < V_I < 5.5 \text{ V}$	2.744	2.856		
	TPS78630	$T_J = 25^\circ\text{C}$ ,		3			V
		$0 \mu\text{A} < I_O < 1.5$ A,	$4 \text{ V} < V_I < 5.5 \text{ V}$	2.94	3.06		
	TPS78633	$T_J = 25^\circ\text{C}$ ,		3.3			V
		$0 \mu\text{A} < I_O < 1.5$ A,	$4.3 \text{ V} < V_I < 5.5 \text{ V}$	3.234	3.366		
Quiescent current (GND current)		$0 \mu\text{A} < I_O < 1.5$ A, $T_J = 25^\circ\text{C}$	260			μA	
			385				
Load regulation		$0 \mu\text{A} < I_O < 1.5$ A, $T_J = 25^\circ\text{C}$	7			mV	
Output voltage line regulation ( $\Delta V_O/V_O$ ) (see Note 7)		$V_O + 1 \text{ V} < V_I \leq 5.5 \text{ V}$ , $T_J = 25^\circ\text{C}$	.05			%V	
			.12				
Output noise voltage (TPS78630)		BW = 100 Hz to 100 kHz, $I_O = 1.5$ A, $T_J = 25^\circ\text{C}$	$C(\text{byp}) = 0.001$ μF	66		μVRMS	
			$C(\text{byp}) = 0.0047$ μF	51			
			$C(\text{byp}) = 0.01$ μF	49			
			$C(\text{byp}) = 0.1$ μF	48			
Time, start-up (TPS78630)		$R_L = 2 \Omega$ , $C_O = 1$ μF, $T_J = 25^\circ\text{C}$	$C(\text{byp}) = 0.001$ μF	50		μs	
			$C(\text{byp}) = 0.0047$ μF	75			
			$C(\text{byp}) = 0.01$ μF	110			
Output current limit		$V_O = 0$ V, See Note 6	2.4		3.5	A	
Standby current		$EN = 0$ V, $2.7 \text{ V} < V_I < 5.5 \text{ V}$	0.07		1	μA	
High level enable input voltage		$2.7 \text{ V} < V_I < 5.5 \text{ V}$	2			V	
Low level enable input voltage		$2.7 \text{ V} < V_I < 5.5 \text{ V}$			0.7	V	
Input current (EN)		$EN = 0$	-1		1	μA	
Input current (FB)		$FB = 1.8$ V			1	μA	

- NOTES: 4. To calculate the minimum input voltage for your maximum output current, use the following formula:  
 $V_I(\text{min}) = V_O(\text{max}) + V_{DO}(\text{max load})$
5. Continuous output current and operating junction temperature are limited by internal protection circuitry, but it is not recommended that the device operate under conditions beyond those specified in this table for extended periods of time.
6. The minimum  $V_{IN}$  operating voltage is 2.7 V or  $V_O(\text{typ}) + 1$  V, whichever is greater. The maximum  $V_{IN}$  voltage is 5.5 V. The maximum continuous output current is 1.5 A.
7. If  $V_O \leq 2.5$  V then  $V_{I\text{min}} = 2.7$  V,  $V_{I\text{max}} = 5.5$  V:

$$\text{Line reg. (mV)} = (\%/\text{V}) \times \frac{V_O(V_{I\text{max}} - 2.7 \text{ V})}{100} \times 1000$$

If  $V_O \geq 2.5$  V then  $V_{I\text{min}} = V_O + 1$  V,  $V_{I\text{max}} = 5.5$  V.

**TPS78601, TPS78618, TPS78625  
TPS78628, TPS78630, TPS78633**

SLVS389A – SEPTEMBER 2002 – REVISED FEBRUARY 2003

**electrical characteristics over recommended operating free-air temperature range  $EN = V_I$ ,  $T_J = -40$  to  $125$  °C,  $V_I = V_{O(typ)} + 1$  V,  $I_O = 1$  mA,  $C_O = 10$   $\mu$ F,  $C_{(byp)} = 0.01$   $\mu$ F (unless otherwise noted) (continued)**

PARAMETER		TEST CONDITIONS	MIN	TYP	MAX	UNIT
Power supply ripple rejection	TPS78630	$f = 100$ Hz, $T_J = 25$ °C, $I_O = 10$ mA		59		dB
		$f = 100$ Hz, $T_J = 25$ °C, $I_O = 1.5$ A		52		
		$f = 10$ kHz, $T_J = 25$ °C, $I_O = 1.5$ A		49		
		$f = 100$ kHz, $T_J = 25$ °C, $I_O = 1.5$ A		32		
Dropout voltage (see Note 8)	TPS78628	$I_O = 1.5$ A, $T_J = 25$ °C		410		mV
		$I_O = 1.5$ A			580	
	TPS78630	$I_O = 1.5$ A, $T_J = 25$ °C		390		
		$I_O = 1.5$ A			550	
	TPS78633	$I_O = 1.5$ A, $T_J = 25$ °C		340		
		$I_O = 1.5$ A			510	

NOTES: 8.  $V_{IN}$  voltage equals  $V_{O(typ)} - 100$  mV; The TPS78625 and TPS78618 dropout voltage is limited by the input voltage range limitations.

**functional block diagram—TPS78633 – adjustable version**

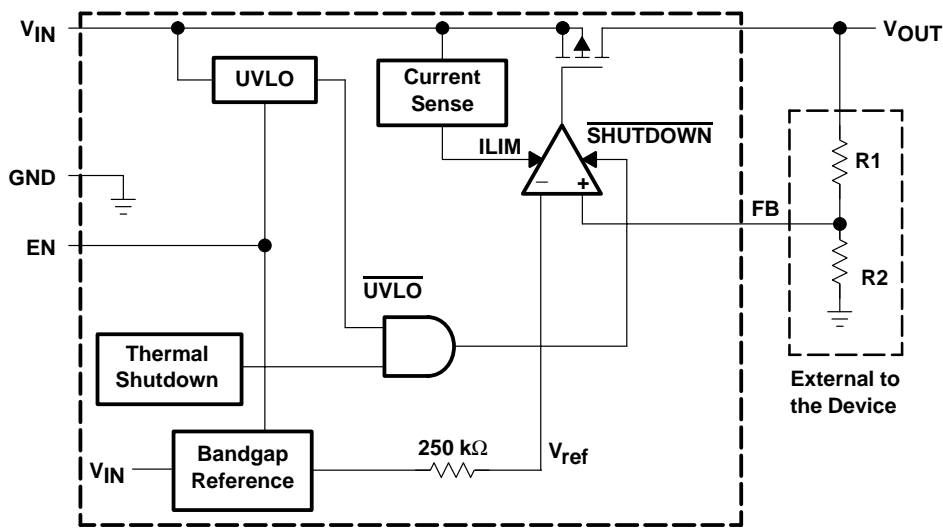

functional block diagram—fixed version

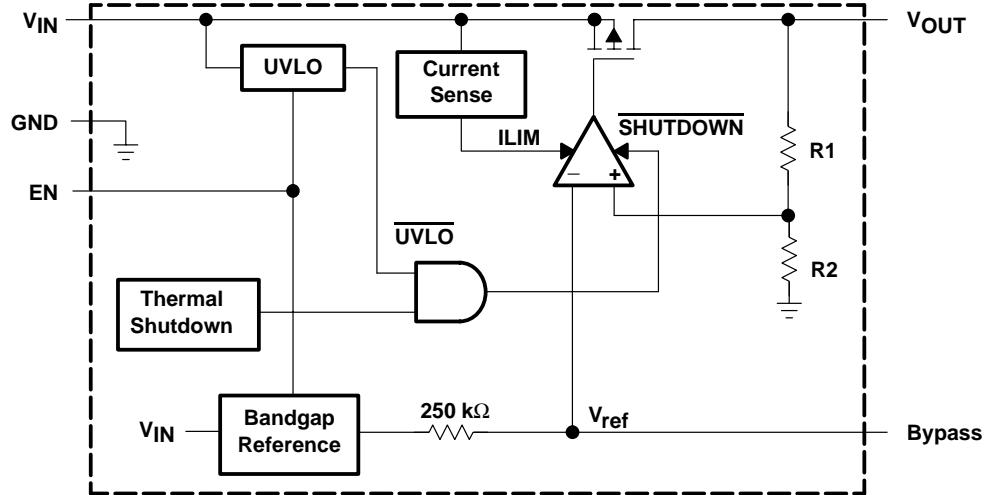

Terminal Functions

TERMINAL			I/O	DESCRIPTION
NAME	ADJ	FIXED		
BYPASS	NA	5		An external bypass capacitor, connected to this terminal, in conjunction with an internal resistor, creates a low-pass filter to further reduce regulator noise.
EN	1	1	I	The EN terminal is an input which enables or shuts down the device. When EN goes to a logic high, the device will be enabled. When the device goes to a logic low, the device is in shutdown mode.
FB	5	N/A	I	This terminal is the feedback input voltage for the adjustable device.
GND	3	3		Regulator ground
V <sub>IN</sub>	2	2	I	The V <sub>IN</sub> terminal is the input to the device.
V <sub>OUT</sub>	4	4	O	The V <sub>OUT</sub> terminal is the regulated output of the device.

TYPICAL CHARACTERISTICS

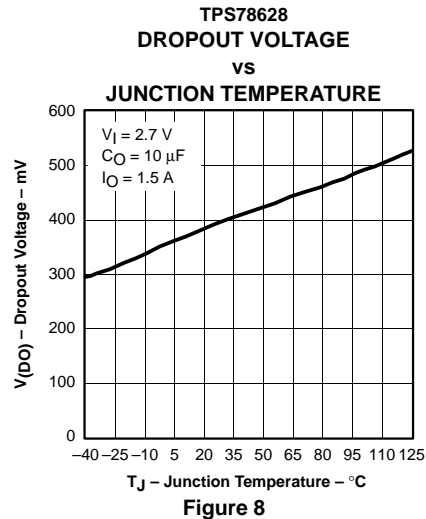
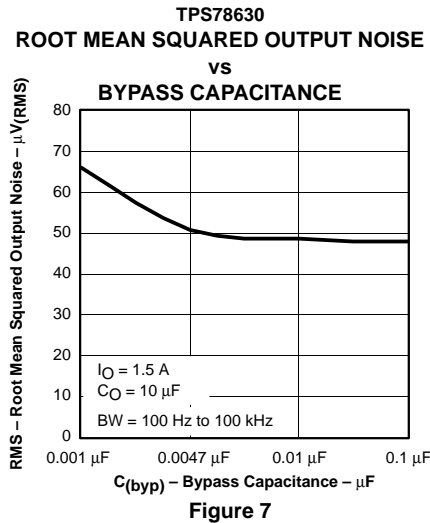
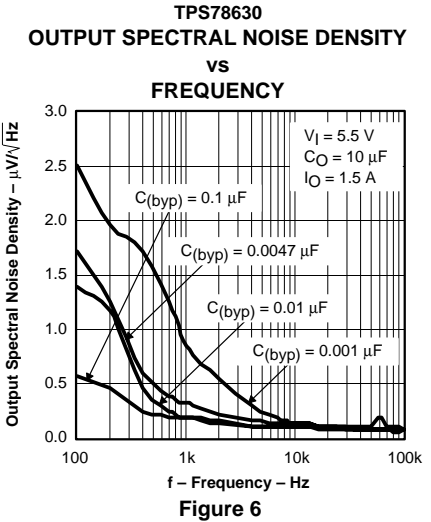
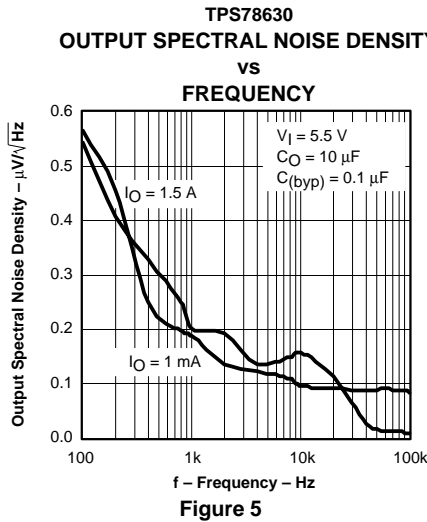
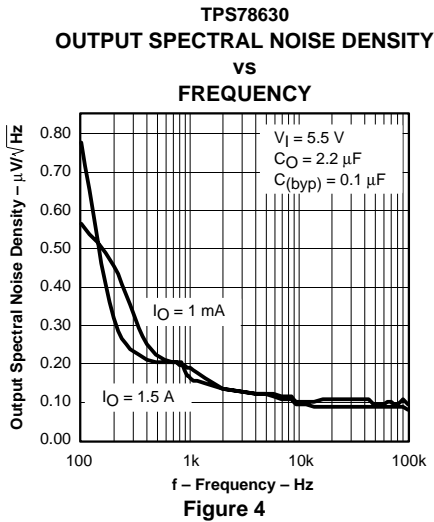
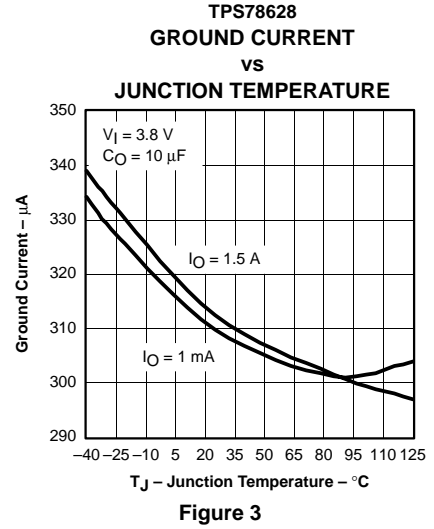
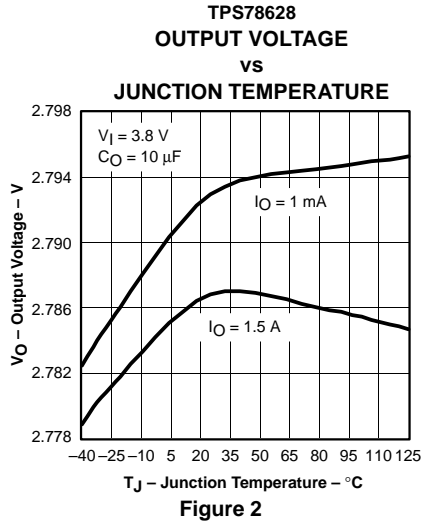
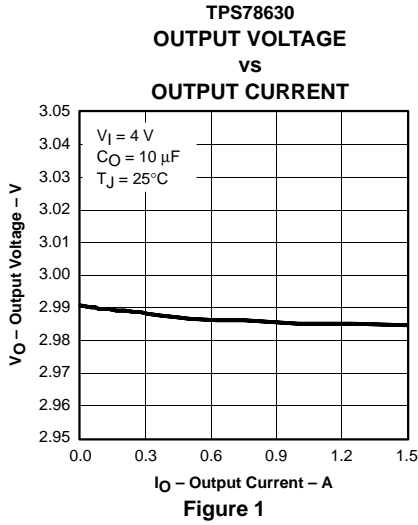

TPS78630  
 RIPPLE REJECTION  
 vs  
 FREQUENCY

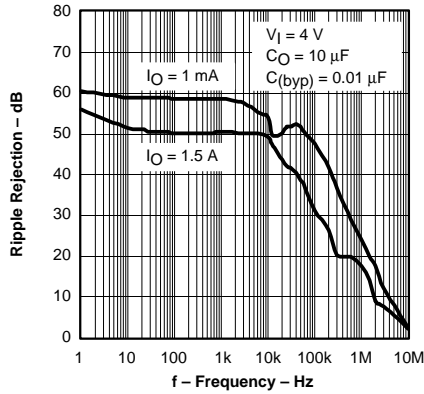

Figure 9

TPS78630  
 RIPPLE REJECTION  
 vs  
 FREQUENCY

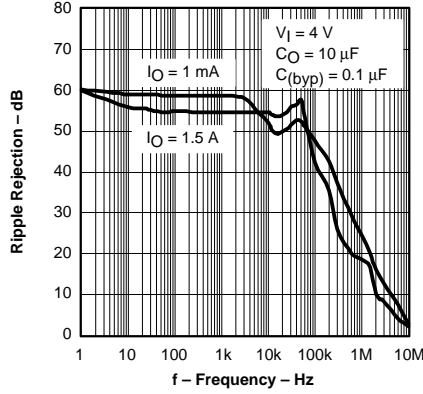

Figure 10

TPS78630  
 RIPPLE REJECTION  
 vs  
 FREQUENCY

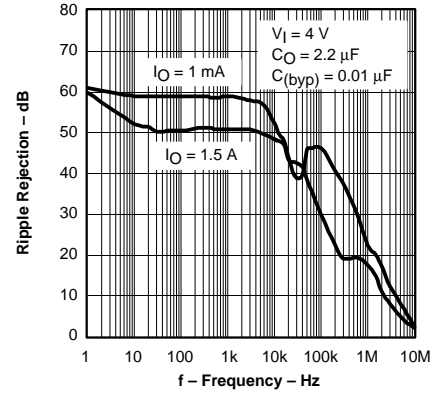

Figure 11

TPS78630  
 RIPPLE REJECTION  
 vs  
 FREQUENCY

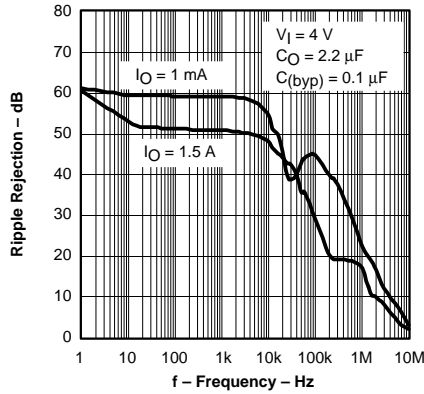

Figure 12

TPS78618  
 LINE TRANSIENT RESPONSE

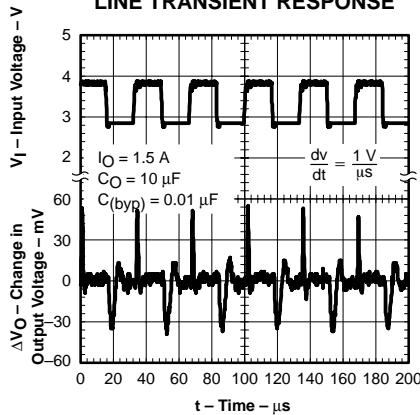

Figure 13

TPS78630  
 LINE TRANSIENT RESPONSE

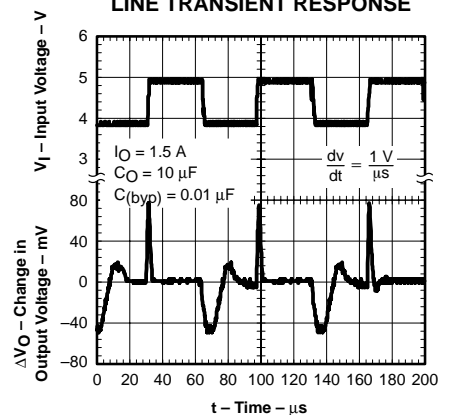

Figure 14

TPS78628  
 LOAD TRANSIENT RESPONSE

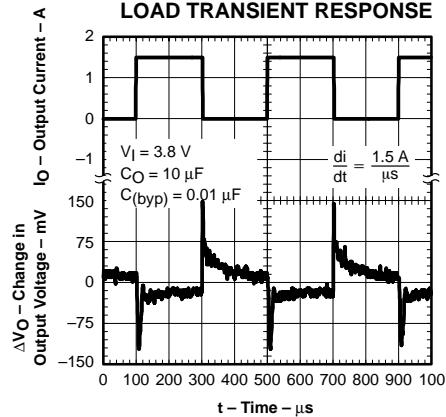

Figure 15

TPS78625  
 POWER UP/POWER DOWN

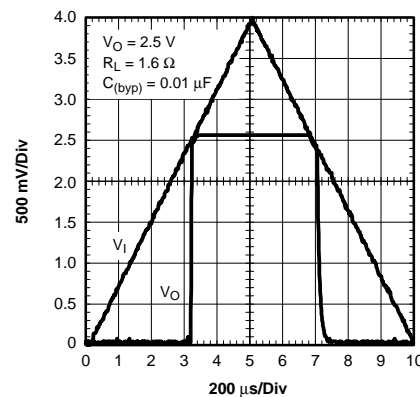

Figure 16

TPS78630  
 DC DROPOUT VOLTAGE  
 vs  
 OUTPUT CURRENT

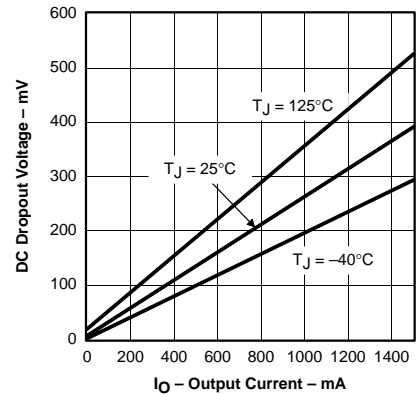

Figure 17

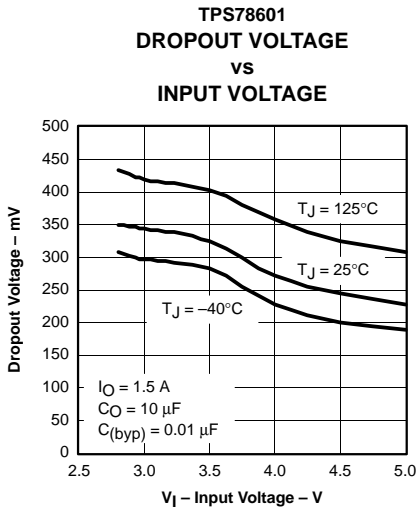

Figure 18

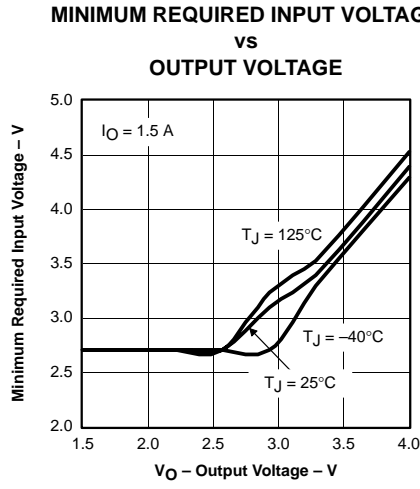

Figure 19

**TPS78630**  
**TYPICAL REGIONS OF STABILITY**  
**EQUIVALENT SERIES RESISTANCE (ESR)**  
**vs**  
**OUTPUT CURRENT**

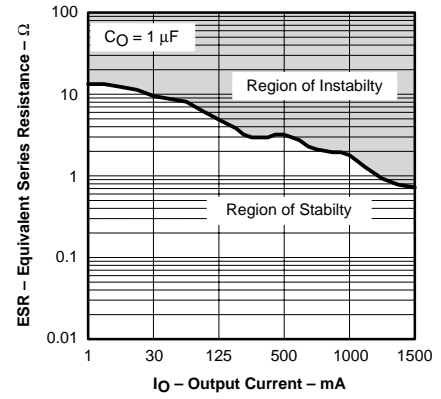

Figure 20

**TPS78630**  
**TYPICAL REGIONS OF STABILITY**  
**EQUIVALENT SERIES RESISTANCE (ESR)**  
**vs**  
**OUTPUT CURRENT**

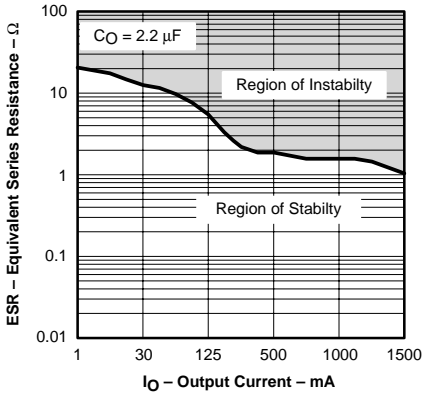

Figure 21

**TPS78630**  
**TYPICAL REGIONS OF STABILITY**  
**EQUIVALENT SERIES RESISTANCE (ESR)**  
**vs**  
**OUTPUT CURRENT**

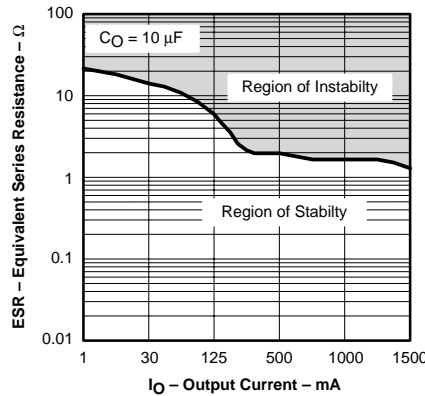

Figure 22

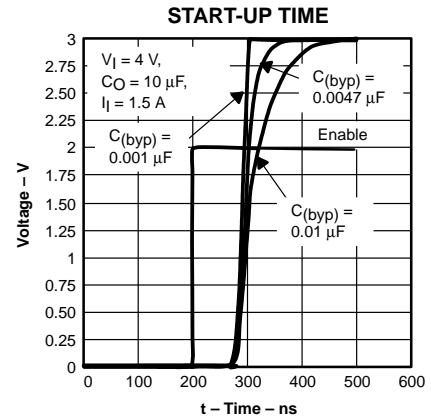

Figure 23



## APPLICATION INFORMATION

The TPS786xx family of low-dropout (LDO) regulators has been optimized for use in noise-sensitive battery-operated equipment. The device features extremely low dropout voltages, high PSRR, ultralow output noise, low quiescent current (265  $\mu\text{A}$  typically), and enable input to reduce supply currents to less than 1  $\mu\text{A}$  when the regulator is turned off.

A typical application circuit is shown in Figure 24.

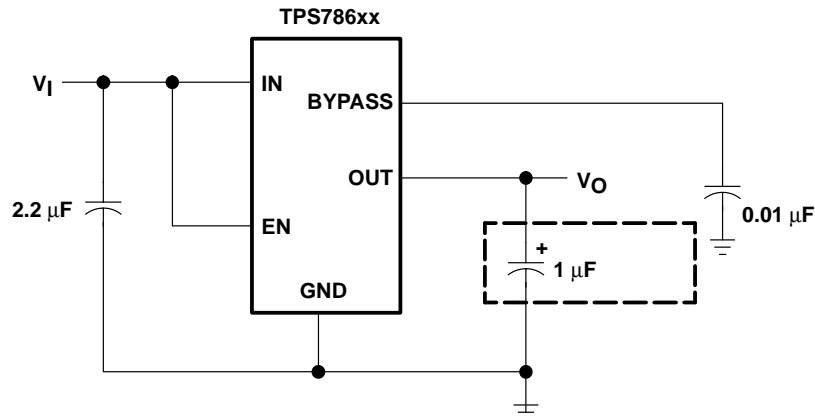

Figure 24. Typical Application Circuit

### external capacitor requirements

A 2.2- $\mu\text{F}$  or larger ceramic input bypass capacitor, connected between IN and GND and located close to the TPS786xx, is required for stability and improves transient response, noise rejection, and ripple rejection. A higher-value electrolytic input capacitor may be necessary if large, fast-rise-time load transients are anticipated and the device is located several inches from the power source.

Like all low dropout regulators, the TPS786xx requires an output capacitor connected between OUT and GND to stabilize the internal control loop. The minimum recommended capacitance is 1  $\mu\text{F}$ . Any 1  $\mu\text{F}$  or larger ceramic capacitor is suitable.

The internal voltage reference is a key source of noise in an LDO regulator. The TPS786xx has a BYPASS pin which is connected to the voltage reference through a 250-k $\Omega$  internal resistor. The 250-k $\Omega$  internal resistor, in conjunction with an external bypass capacitor connected to the BYPASS pin, creates a low pass filter to reduce the voltage reference noise and, therefore, the noise at the regulator output. In order for the regulator to operate properly, the current flow out of the BYPASS pin must be at a minimum, because any leakage current creates an IR drop across the internal resistor, thus creating an output error. Therefore, the bypass capacitor must have minimal leakage current.

For example, the TPS78630 exhibits only 48  $\mu\text{V}_{\text{RMS}}$  of output voltage noise using a 0.1- $\mu\text{F}$  ceramic bypass capacitor and a 10- $\mu\text{F}$  ceramic output capacitor. Note that the output starts up slower as the bypass capacitance increases due to the RC time constant at the bypass pin that is created by the internal 250-k $\Omega$  resistor and external capacitor.

### board layout recommendation to improve PSRR and noise performance

To improve ac measurements like PSRR, output noise, and transient response, it is recommended that the board be designed with separate ground planes for  $V_{\text{IN}}$  and  $V_{\text{OUT}}$ , with each ground plane connected only at the ground pin of the device. In addition, the ground connection for the bypass capacitor should connect directly to the ground pin of the device.

**regulator mounting**

The tab of the SOT223-5 package is electrically connected to ground. For best thermal performance, the tab of the surface-mount version should be soldered directly to a circuit-board copper area. Increasing the copper area improves heat dissipation.

Although the tab of the SOT223–5 is electrically grounded, it is not intended to carry any current. The copper pad that acts as a heat sink should be isolated from the rest of the circuit to prevent current flow through the device from the tab to the ground pin. Solder pad footprint recommendations for the devices are presented in an application bulletin *Solder Pad Recommendations for Surface-Mount Devices*, literature number AB–132, available from the TI web site ([www.ti.com](http://www.ti.com)).

**programming the TPS78601 adjustable LDO regulator**

The output voltage of the TPS78601 adjustable regulator is programmed using an external resistor divider as shown in Figure 29. The output voltage is calculated using:

$$V_O = V_{ref} \times \left(1 + \frac{R1}{R2}\right)$$

where

$$V_{ref} = 1.2246 \text{ V typ (the internal reference voltage)} \tag{1}$$

Resistors R1 and R2 should be chosen for approximately 40-μA divider current. Lower value resistors can be used for improved noise performance, but the device wastes more power. Higher values should be avoided, as leakage current at FB increases the output voltage error. The recommended design procedure is to choose R2 = 30.1 kΩ to set the divider current at 40 μA, C1 = 15 pF for stability, and then calculate R1 using:

$$R1 = \left(\frac{V_O}{V_{ref}} - 1\right) \times R2 \tag{2}$$

In order to improve the stability of the adjustable version, it is suggested that a small compensation capacitor be placed between OUT and FB. The approximate value of this capacitor can be calculated as:

$$C1 = \frac{(3 \times 10^{-7}) \times (R1 + R2)}{(R1 \times R2)} \tag{3}$$

The suggested value of this capacitor for several resistor ratios is shown in the table below. If this capacitor is not used (such as in a unity-gain configuration) then the minimum recommended output capacitor is 2.2 μF instead of 1 μF.

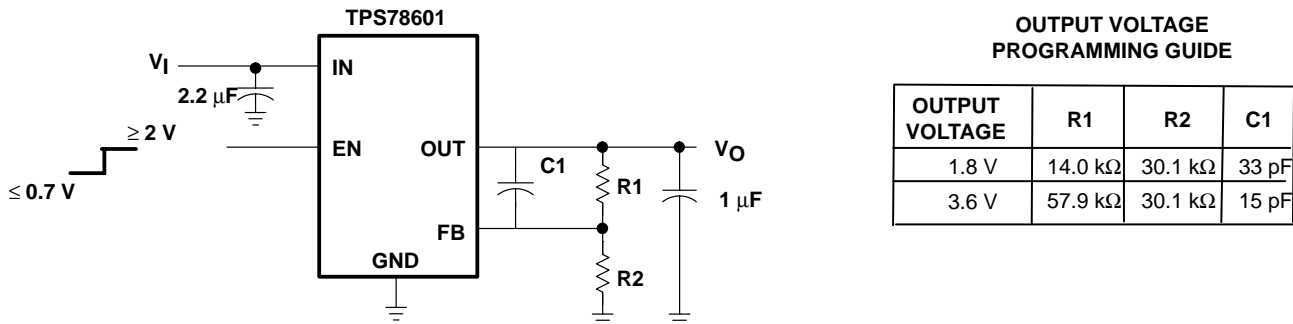

**Figure 25. TPS78601 Adjustable LDO Regulator Programming**

## regulator protection

The TPS786xx PMOS-pass transistor has a built-in back diode that conducts reverse current when the input voltage drops below the output voltage (e.g., during power down). Current is conducted from the output to the input and is not internally limited. If extended reverse voltage operation is anticipated, external limiting might be appropriate.

The TPS786xx features internal current limiting and thermal protection. During normal operation, the TPS786xx limits output current to approximately 2.8 A. When current limiting engages, the output voltage scales back linearly until the overcurrent condition ends. While current limiting is designed to prevent gross device failure, care should be taken not to exceed the power dissipation ratings of the package. If the temperature of the device exceeds approximately 165°C, thermal-protection circuitry shuts it down. Once the device has cooled down to below approximately 140°C, regulator operation resumes.

## THERMAL INFORMATION

The amount of heat that an LDO linear regulator generates is directly proportional to the amount of power it dissipates during operation. All integrated circuits have a maximum allowable junction temperature ( $T_{Jmax}$ ) above which normal operation is not assured. A system designer must design the operating environment so that the operating junction temperature ( $T_J$ ) does not exceed the maximum junction temperature ( $T_{Jmax}$ ). The two main environmental variables that a designer can use to improve thermal performance are air flow and external heatsinks. The purpose of this information is to aid the designer in determining the proper operating environment for a linear regulator that is operating at a specific power level.

In general, the maximum expected power ( $P_{D(max)}$ ) consumed by a linear regulator is computed as:

$$P_{Dmax} = (V_{I(avg)} - V_{O(avg)}) \times I_{O(avg)} + V_{I(avg)} \times I_{(Q)} \quad (3)$$

where:

$V_{I(avg)}$  is the average input voltage.

$V_{O(avg)}$  is the average output voltage.

$I_{O(avg)}$  is the average output current.

$I_{(Q)}$  is the quiescent current.

For most TI LDO regulators, the quiescent current is insignificant compared to the average output current; therefore, the term  $V_{I(avg)} \times I_{(Q)}$  can be neglected. The operating junction temperature is computed by adding the ambient temperature ( $T_A$ ) and the increase in temperature due to the regulator's power dissipation. The temperature rise is computed by multiplying the maximum expected power dissipation by the sum of the thermal resistances between the junction and the case ( $R_{\theta JC}$ ), the case to heatsink ( $R_{\theta CS}$ ), and the heatsink to ambient ( $R_{\theta SA}$ ). Thermal resistances are measures of how effectively an object dissipates heat. Typically, the larger the device, the more surface area available for power dissipation and the lower the object's thermal resistance.

Figure 26 illustrates these thermal resistances for (a) a SOT223 package mounted in a JEDEC low-K board, and (b) a DDPK package mounted on a JEDEC high-K board.

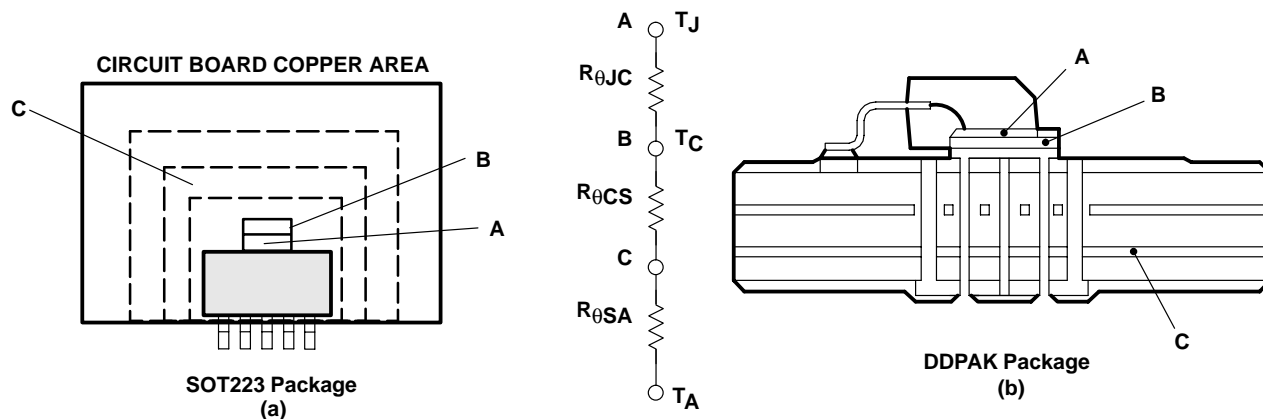

Figure 26. Thermal Resistances

Equation 4 summarizes the computation:

$$T_J = T_A + P_{D,max} \times (R_{\theta JC} + R_{\theta CS} + R_{\theta SA}) \quad (4)$$

The  $R_{\theta JC}$  is specific to each regulator as determined by its package, lead frame, and die size provided in the regulator's data sheet. The  $R_{\theta SA}$  is a function of the type and size of heatsink. For example, *black body radiator* type heatsinks can have  $R_{\theta CS}$  values ranging from 5°C/W for very large heatsinks to 50°C/W for very small heatsinks. The  $R_{\theta CS}$  is a function of how the package is attached to the heatsink. For example, if a thermal compound is used to attach a heatsink to a SOT223 package,  $R_{\theta CS}$  of 1°C/W is reasonable.

Even if no external *black body radiator* type heatsink is attached to the package, the board on which the regulator is mounted provides some heatsinking through the pin solder connections. Some packages, like the DDPAK and SOT223 packages, use a copper plane underneath the package or the circuit board's ground plane for additional heatsinking to improve their thermal performance. Computer aided thermal modeling can be used to compute very accurate approximations of an integrated circuit's thermal performance in different operating environments (e.g., different types of circuit boards, different types and sizes of heatsinks, and different air flows, etc.). Using these models, the three thermal resistances can be combined into one thermal resistance between junction and ambient ( $R_{\theta JA}$ ). This  $R_{\theta JA}$  is valid only for the specific operating environment used in the computer model.

Equation 4 simplifies into equation 5:

$$T_J = T_A + P_{D,max} \times R_{\theta JA} \quad (5)$$

Rearranging equation 5 gives equation 6:

$$R_{\theta JA} = \frac{T_J - T_A}{P_{D,max}} \quad (6)$$

Using equation 5 and the computer model generated curves shown in Figure 27 and Figure 30, a designer can quickly compute the required heatsink thermal resistance/board area for a given ambient temperature, power dissipation, and operating environment.

## DDPAK power dissipation

The DDPACK package provides an effective means of managing power dissipation in surface mount applications. The DDPACK package dimensions are provided in the *Mechanical Data* section at the end of the data sheet. The addition of a copper plane directly underneath the DDPACK package enhances the thermal performance of the package.

To illustrate, the TPS78625 in a DDPACK package was chosen. For this example, the average input voltage is 5 V, the output voltage is 2.5 V, the average output current is 1 A, the ambient temperature 55°C, the air flow is 150 LFM, and the operating environment is the same as documented below. Neglecting the quiescent current, the maximum average power is:

$$P_{Dmax} = (5 - 2.5) V \times 1 A = 2.5 W \quad (7)$$

Substituting  $T_{Jmax}$  for  $T_J$  into equation 6 gives equation 8:

$$R_{\theta JAmax} = (125 - 55)^\circ C / 2.5 W = 28^\circ C/W \quad (8)$$

From Figure 27, DDPACK Thermal Resistance vs Copper Heatsink Area, the ground plane needs to be 1 cm<sup>2</sup> for the part to dissipate 2.5 W. The operating environment used in the computer model to construct Figure 27 consisted of a standard JEDEC High-K board (2S2P) with a 1 oz. internal copper plane and ground plane. The package is soldered to a 2 oz. copper pad. The pad is tied through thermal vias to the 1 oz. ground plane. Figure 28 shows the side view of the operating environment used in the computer model.

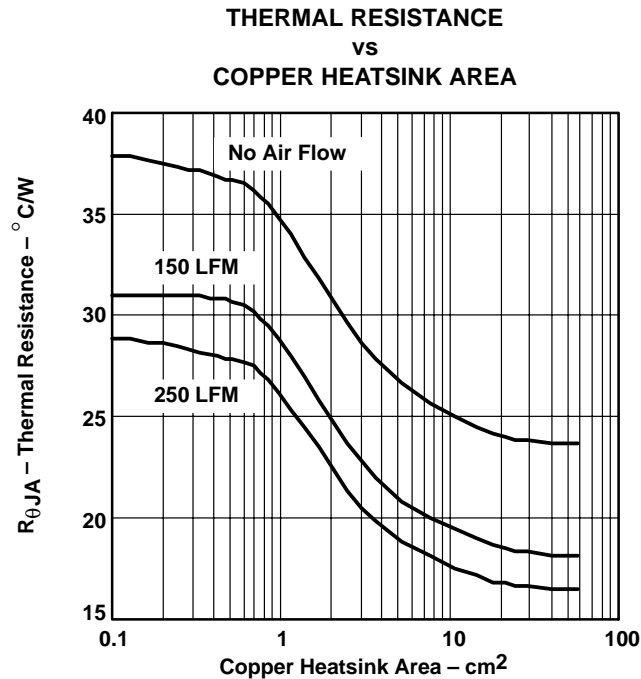

Figure 27. DDPACK Thermal Resistance vs Copper Heatsink Area

DDPAK power dissipation (continued)

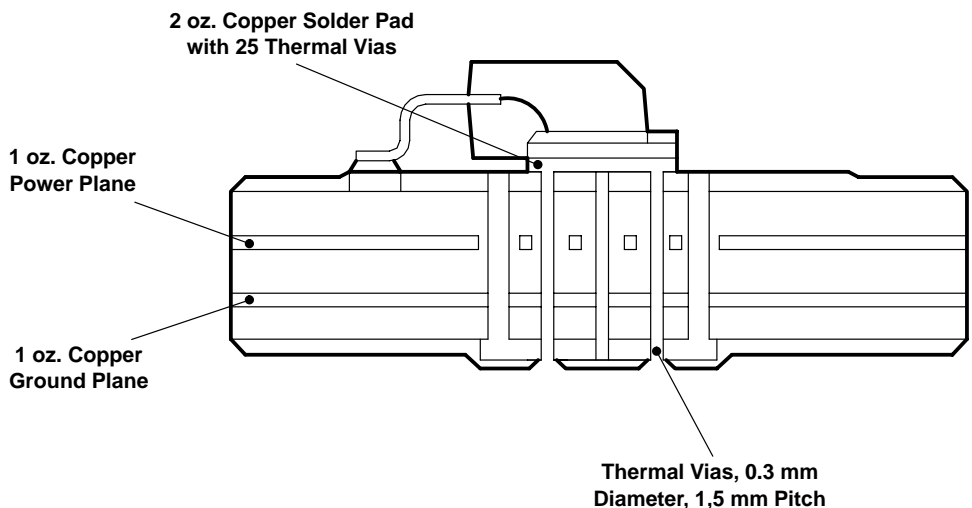

Figure 28. DDPAK Thermal Resistance

From the data in Figure 29 and rearranging equation 6, the maximum power dissipation for a different ground plane area and a specific ambient temperature can be computed.

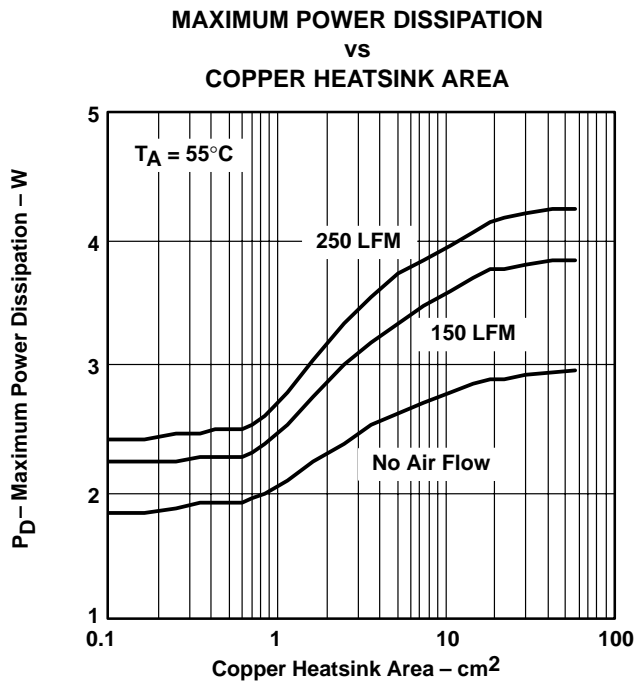

Figure 29. Maximum Power Dissipation vs Copper Heatsink Area

## SOT223 power dissipation

The SOT223 package provides an effective means of managing power dissipation in surface mount applications. The SOT223 package dimensions are provided in the *Mechanical Data* section at the end of the data sheet. The addition of a copper plane directly underneath the SOT223 package enhances the thermal performance of the package.

To illustrate, the TPS78625 in a SOT223 package was chosen. For this example, the average input voltage is 3.3 V, the output voltage is 2.5 V, the average output current is 1 A, the ambient temperature 55°C, no air flow is present, and the operating environment is the same as documented below. Neglecting the quiescent current, the maximum average power is:

$$P_{Dmax} = (3.3 - 2.5) V \times 1 A = 800 \text{ mW} \quad (9)$$

Substituting  $T_{Jmax}$  for  $T_J$  into equation 6 gives equation 10:

$$R_{\theta JAmax} = (125 - 55)^\circ\text{C}/800 \text{ mW} = 87.5^\circ\text{C}/\text{W} \quad (10)$$

From Figure 30,  $R_{\theta JA}$  vs PCB Copper Area, the ground plane needs to be 0.55 in<sup>2</sup> for the part to dissipate 800 mW. The operating environment used to construct Figure 30 consisted of a board with 1 oz. copper planes. The package is soldered to a 1 oz. copper pad on the top of the board. The pad is tied through thermal vias to the 1 oz. ground plane.

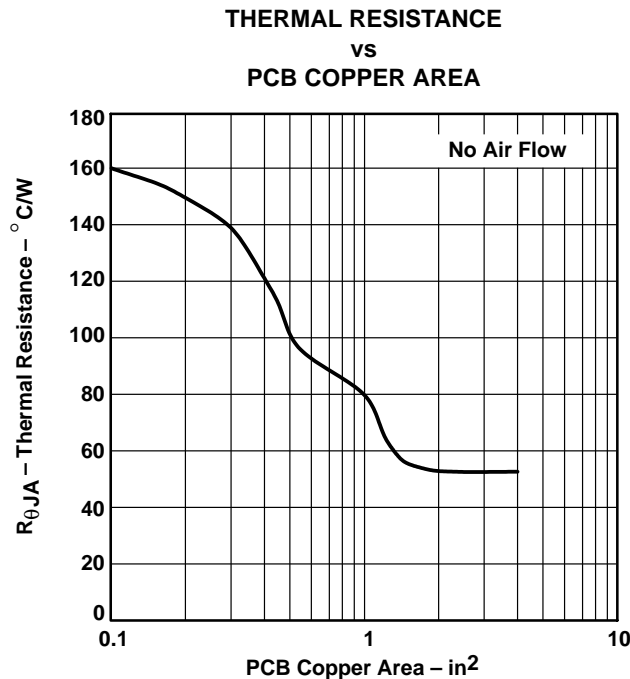

Figure 30. SOT223 Thermal Resistance vs PCB AREA

From the data in Figure 30 and rearranging equation 6, the maximum power dissipation for a different ground plane area and a specific ambient temperature can be computed (see Figure 31).

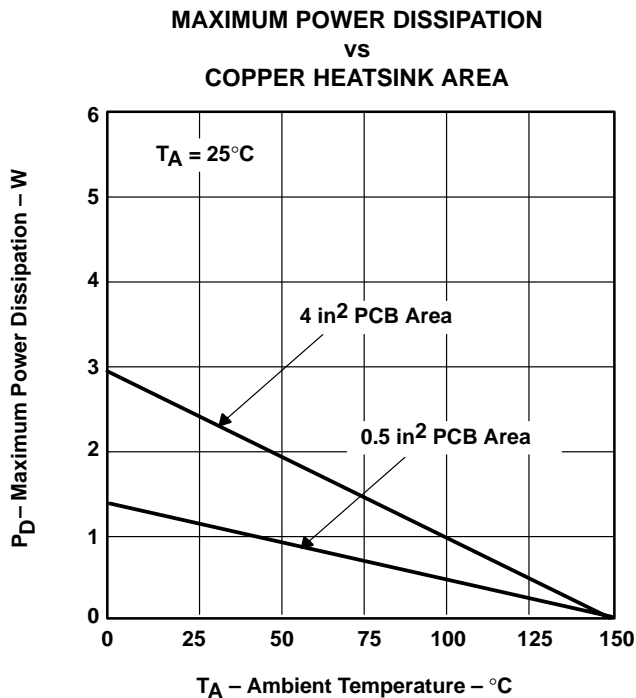

Figure 31. SOT223 Power Dissipation



MECHANICAL DATA

DCQ (R-PDSO-G6)

PLASTIC SMALL-OUTLINE

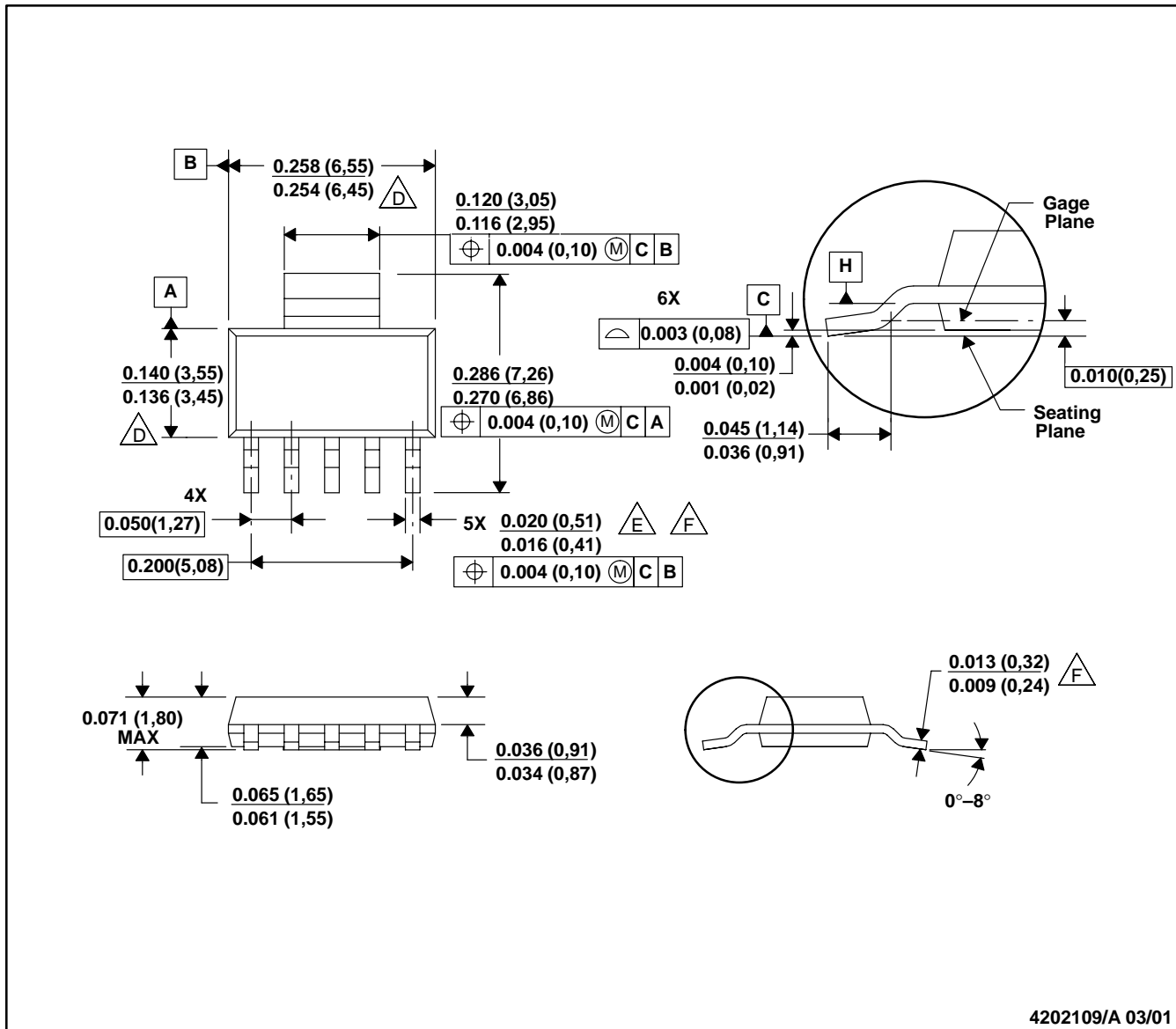

4202109/A 03/01

- NOTES: A. All linear dimensions are in inches (millimeters).  
 B. This drawing is subject to change without notice.  
 C. Controlling dimension in inches  
 D. Body length and width dimensions are determined at the outermost extremes of the plastic body exclusive of mold flash, tie bar burrs, gate burrs, and interlead flash, but including any mismatch between the top and the bottom of the plastic body.  
 E. Lead width and thickness dimensions apply to solder plated leads.  
 F. Interlead flash allow 0.008 inch max.  
 G. Gate burr/protrusion max. 0.006 inch.

MECHANICAL DATA

KTT (R-PSFM-G5)

PLASTIC FLANGE-MOUNT

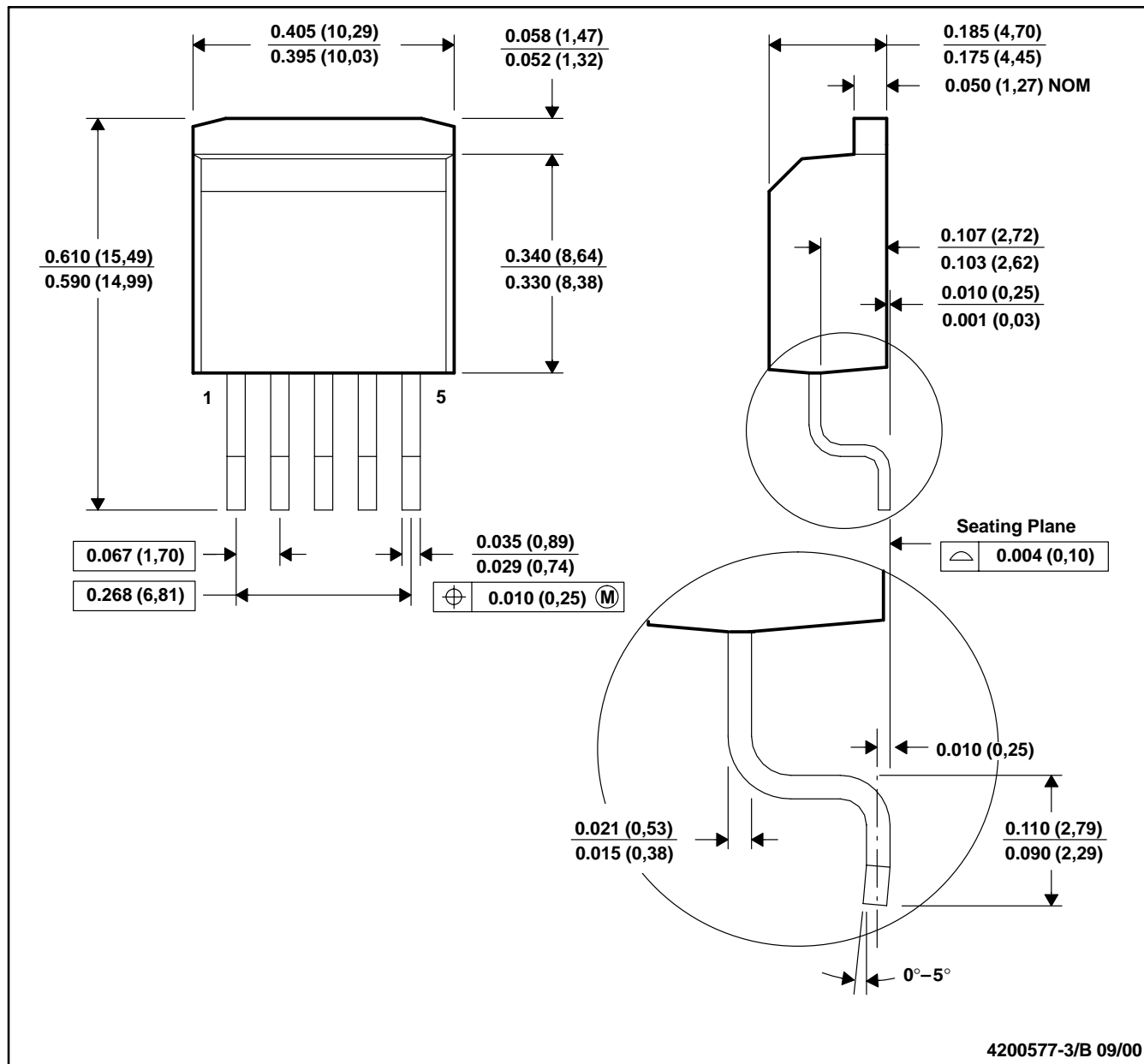

- NOTES: A. All linear dimensions are in inches (millimeters).  
 B. This drawing is subject to change without notice.  
 C. Dimensions do not include mold protrusions, not to exceed 0.006 (0,15).

## IMPORTANT NOTICE

Texas Instruments Incorporated and its subsidiaries (TI) reserve the right to make corrections, modifications, enhancements, improvements, and other changes to its products and services at any time and to discontinue any product or service without notice. Customers should obtain the latest relevant information before placing orders and should verify that such information is current and complete. All products are sold subject to TI's terms and conditions of sale supplied at the time of order acknowledgment.

TI warrants performance of its hardware products to the specifications applicable at the time of sale in accordance with TI's standard warranty. Testing and other quality control techniques are used to the extent TI deems necessary to support this warranty. Except where mandated by government requirements, testing of all parameters of each product is not necessarily performed.

TI assumes no liability for applications assistance or customer product design. Customers are responsible for their products and applications using TI components. To minimize the risks associated with customer products and applications, customers should provide adequate design and operating safeguards.

TI does not warrant or represent that any license, either express or implied, is granted under any TI patent right, copyright, mask work right, or other TI intellectual property right relating to any combination, machine, or process in which TI products or services are used. Information published by TI regarding third-party products or services does not constitute a license from TI to use such products or services or a warranty or endorsement thereof. Use of such information may require a license from a third party under the patents or other intellectual property of the third party, or a license from TI under the patents or other intellectual property of TI.

Reproduction of information in TI data books or data sheets is permissible only if reproduction is without alteration and is accompanied by all associated warranties, conditions, limitations, and notices. Reproduction of this information with alteration is an unfair and deceptive business practice. TI is not responsible or liable for such altered documentation.

Resale of TI products or services with statements different from or beyond the parameters stated by TI for that product or service voids all express and any implied warranties for the associated TI product or service and is an unfair and deceptive business practice. TI is not responsible or liable for any such statements.

### Mailing Address:

Texas Instruments  
Post Office Box 655303  
Dallas, Texas 75265