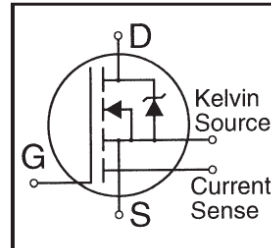


# IRCZ44PbF

## HEXFET® Power MOSFET

- Dynamic dv/dt Rating
- Current Sense
- 175°C Operating Temperature
- Fast Switching
- Ease of Paralleling
- Simple Drive Requirements
- Lead-Free

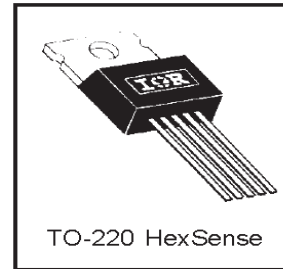


$V_{DSS} = 60V$
$R_{DS(on)} = 0.028\Omega$
$I_D = 50*A$

### Description

Third Generation HEXFETs from International Rectifier provide the designer with the best combination of fast switching, ruggedized device, low on-resistance and cost-effectiveness.

The HEXSense device provides an accurate fraction of the drain current through the additional two leads to be used for control or protection of the device. These devices exhibit similar electrical and thermal characteristics as their IRF-series equivalent part numbers. The provision of a kelvin source connection effectively eliminates problems of common source inductance when the HEXSense is used as a fast, high-current switch in non current-sensing applications.



### Absolute Maximum Ratings

Parameter		Max.	Units
$I_D @ T_C = 25^\circ C$	Continuous Drain Current, $V_{GS} @ 10V$	50*	A
$I_D @ T_C = 100^\circ C$	Continuous Drain Current, $V_{GS} @ 10V$	37	
$I_{DM}$	Pulsed Drain Current ①	210	
$P_D @ T_C = 25^\circ C$	Power Dissipation	150	W
	Linear Derating Factor	1.0	W/°C
$V_{GS}$	Gate-to-Source Voltage	±20	V
$E_{AS}$	Single Pulse Avalanche Energy ②	30	mJ
dv/dt	Peak Diode Recovery dv/dt ③	4.5	V/ns
$T_J$	Operating Junction and	-55 to + 175	°C
$T_{STG}$	Storage Temperature Range		
	Soldering Temperature, for 10 seconds	300 (1.6mm from case)	
	Mounting Torque, 6-32 or M3 screw	10 lbf•in (1.1 N•m)	

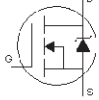
### Thermal Resistance

	Parameter	Min.	Typ.	Max.	Units
$R_{\theta JC}$	Junction-to-Case	—	—	1.0	°C/W
$R_{\theta CS}$	Case-to-Sink, Flat, Greased Surface	—	0.50	—	
$R_{\theta JA}$	Junction-to-Ambient —	—	—	62	

## Electrical Characteristics @ $T_J = 25^\circ\text{C}$ (unless otherwise specified)

Parameter		Min.	Typ.	Max.	Units	Conditions
$V_{(BR)DSS}$	Drain-to-Source Breakdown Voltage	60	---	---	V	$V_{GS} = 0V, I_D = 250\mu A$
$\Delta V_{(BR)DSS}/\Delta T_J$	Breakdown Voltage Temp. Coefficient	---	0.060	---	V/°C	Reference to $25^\circ\text{C}$ , $I_D = 1mA$
$R_{DS(ON)}$	Static Drain-to-Source On-Resistance	---	---	0.028	$\Omega$	$V_{GS} = 10V, I_D = 31A$ ①
$V_{GS(th)}$	Gate Threshold Voltage	2.0	---	4.0	V	$V_{DS} = V_{GS}, I_D = 250\mu A$
$g_{fs}$	Forward Transconductance	18	---	---	S	$V_{DS} = 25V, I_D = 31A$
$I_{DSS}$	Drain-to-Source Leakage Current	---	---	25		$V_{DS} = 60V, V_{GS} = 0V$
	Gate-to-Source Forward Leakage	---	---	250		$V_{DS} = 48V, V_{GS} = 0V, T_J = 150^\circ\text{C}$
$I_{GSS}$	Gate-to-Source Reverse Leakage	---	---	100		$V_{GS} = 20V$
	Gate-to-Source Reverse Leakage	---	---	-100		$V_{GS} = -20V$
$Q_g$	Total Gate Charge	---	---	95		$I_D = 52A$
$Q_{gs}$	Gate-to-Source Charge	---	---	27	nC	$V_{DS} = 48V$
$Q_{gd}$	Gate-to-Drain ("Miller") Charge	---	---	46		$V_{GS} = 10V$ , See Fig. 6 and 13 ④
$t_{d(on)}$	Turn-On Delay Time	---	19	---		$V_{DD} = 30V$
$t_r$	Rise Time	---	120	---		$I_D = 52A$
$t_{d(off)}$	Turn-Off Delay Time	---	55	---		$R_G = 9.1\Omega$
$t_f$	Fall Time	---	86	---		$R_D = 0.54\Omega$ , See Fig. 10 ④
$L_D$	Internal Drain Inductance	---	4.5	---	nH	Between lead, 6 mm (0.25in.) from package and center of die contact
$L_C$	Internal Source Inductance	---	7.5	---		
$C_{iss}$	Input Capacitance	---	2500	---		$V_{GS} = 0V$
$C_{oss}$	Output Capacitance	---	1200	---	pF	$V_{DS} = 25V$
$C_{rss}$	Reverse Transfer Capacitance	---	200	---		$f = 1.0MHz$ , See Fig. 5
$r$	Current Sensing Ratio	2460	---	2720	---	$I_D = 52A, V_{GS} = 10V$
$C_{oss}$	Output Capacitance of Sensing Cells	---	9.0	---	pF	$V_{GS} = 0V, V_{DS} = 25V, f = 1.0MHz$

## Source-Drain Ratings and Characteristics

Parameter		Min.	Typ.	Max.	Units	Conditions
$I_S$	Continuous Source Current (Body Diode)	---	---	50*	A	MOSFET symbol showing the integral reverse p-n junction diode. 
$I_{SM}$	Pulsed Source Current (Body Diode) ①	---	---	210		
$V_{SD}$	Diode Forward Voltage	---	---	2.5	V	$T_J = 25^\circ\text{C}, I_S = 52A, V_{GS} = 0V$ ④
$t_{rr}$	Reverse Recovery Time	---	140	300	ns	$T_J = 25^\circ\text{C}, I_F = 52A$
$Q_R$	Reverse Recovery Charge	---	1.2	2.8	nC	$di/dt = 100A/\mu s$ ②
$t_{on}$	Forward Turn-On Time	Intrinsic turn-on time is negligible (turn-on is dominated by $L_S+L_D$ )				

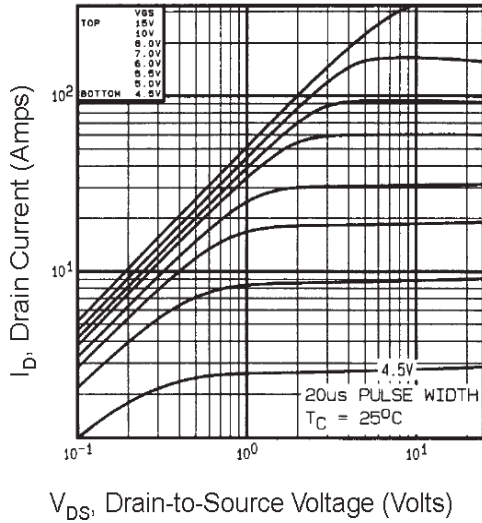
### Notes:

① Repetitive rating; pulse width limited by max. junction temperature. ( See fig. 11 )

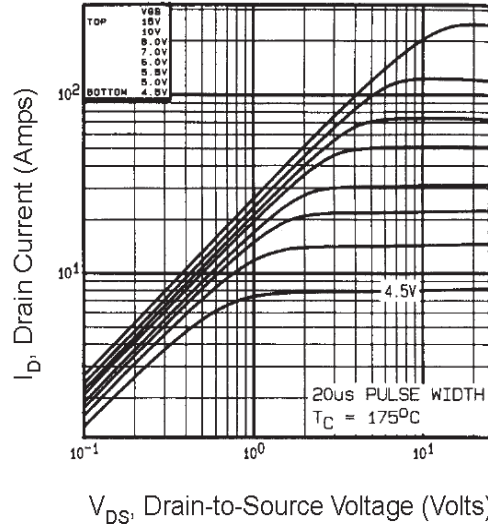
②  $I_{SD} \leq 52A, di/dt \leq 250A/\mu s, V_{DD} \leq V_{(BR)DSS}, T_J \leq 175^\circ\text{C}$

③  $V_{DD} = 25V, \text{ starting } T_J = 25^\circ\text{C}, L = 0.013mH, R_G = 25\Omega, I_{AS} = 52A. (\text{See Figure 12})$

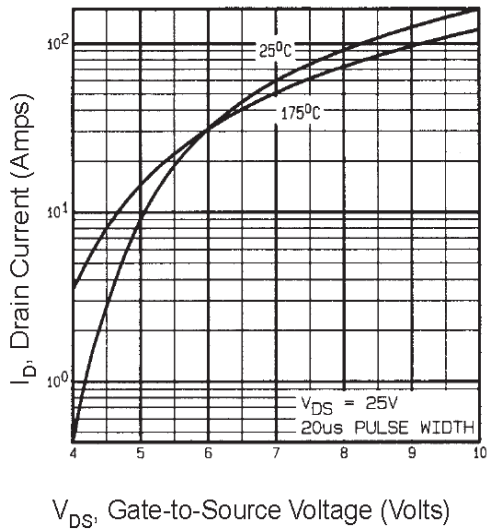
④ Pulse width  $\leq 300\mu s$ ; duty cycle  $\leq 2\%$ .



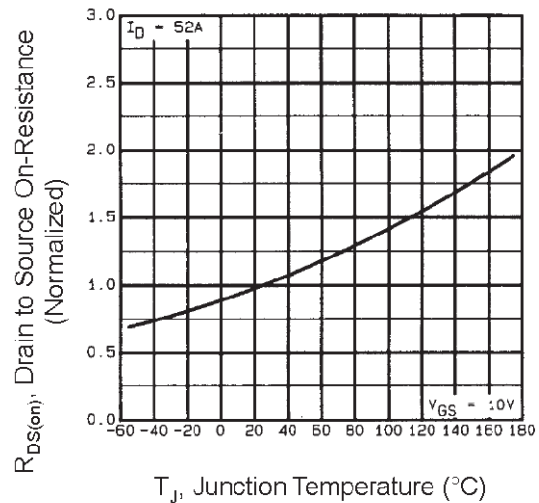
**Fig. 1 Typical Output Characteristics,**  
 $T_C = 25^\circ\text{C}$



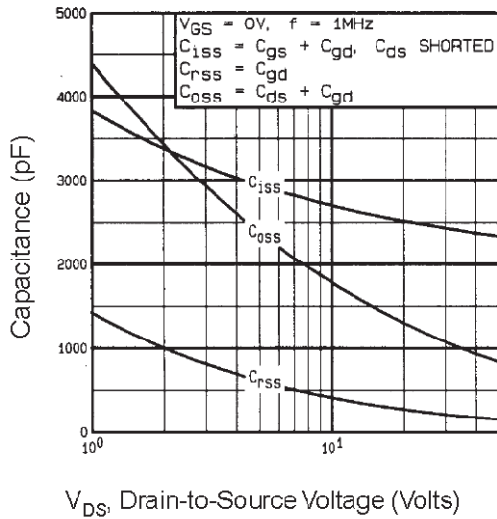
**Fig. 2 Typical Output Characteristics,**  
 $T_C = 175^\circ\text{C}$



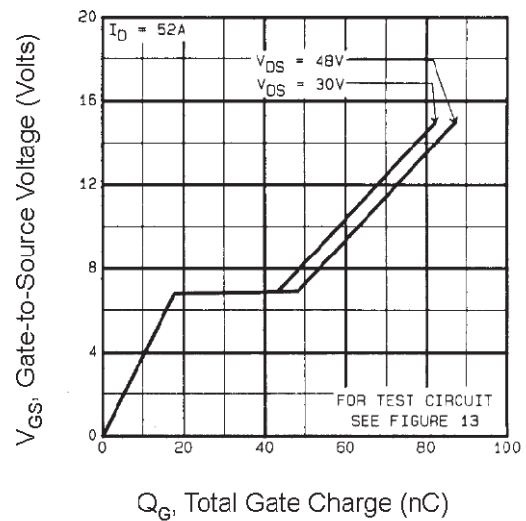
**Fig. 3 Typical Transfer Characteristics**



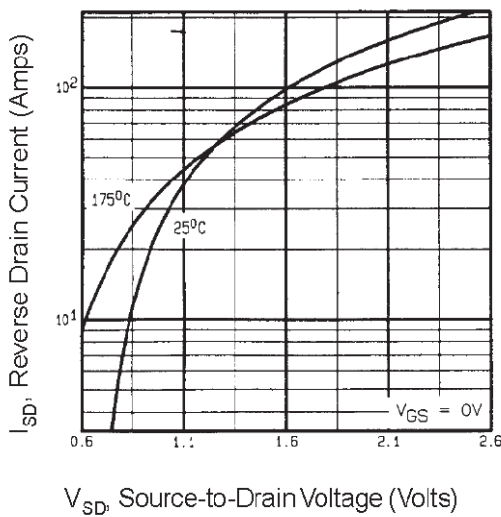
**Fig. 4 Normalized On-Resistance vs.**  
**Temperature**



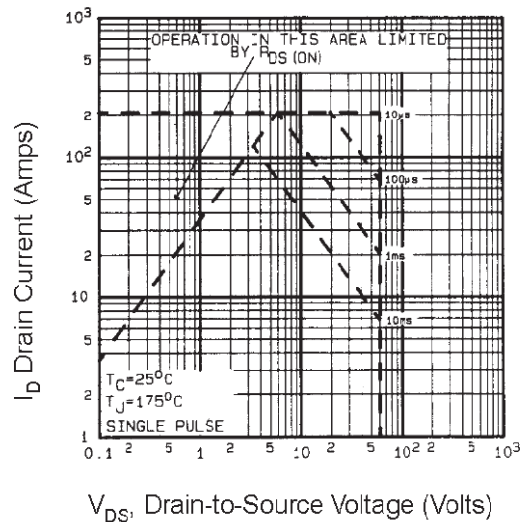
**Fig. 5 Typical Capacitance vs. Drain-to-Source Voltage**



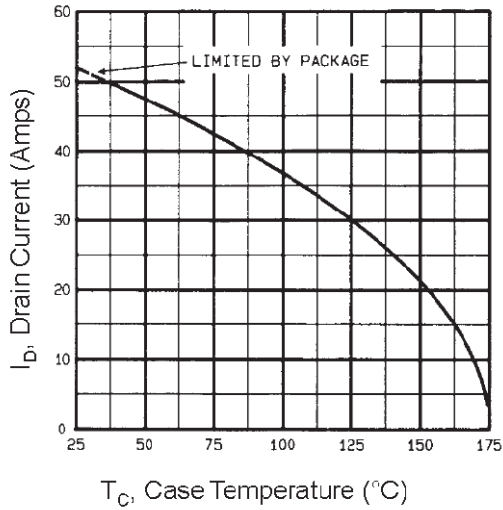
**Fig. 6 Typical Gate Charge vs. Gate-to-Source Voltage**



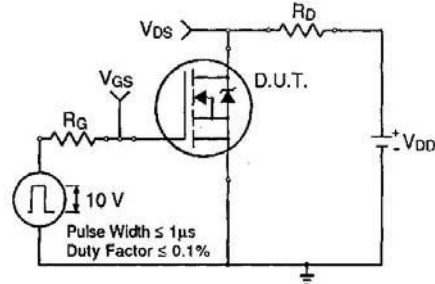
**Fig. 7 Typical Source-Drain Diode Forward Voltage**



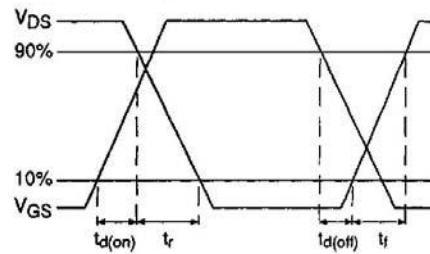
**Fig. 8 Maximum Safe Operating Area**



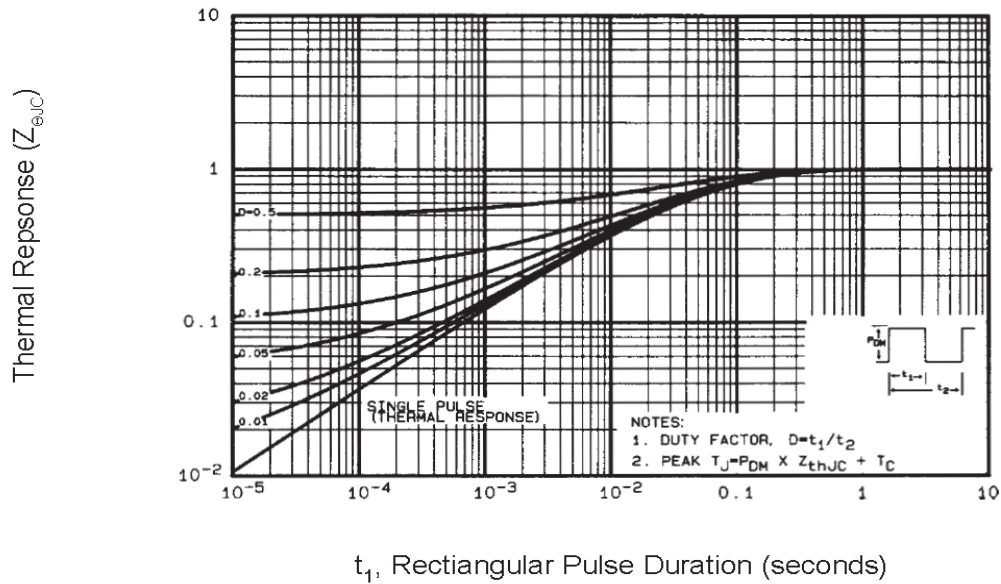
**Fig. 9 Maximum Drain Current vs. Case Temperature**



**Fig 10a. Switching Time Test Circuit**



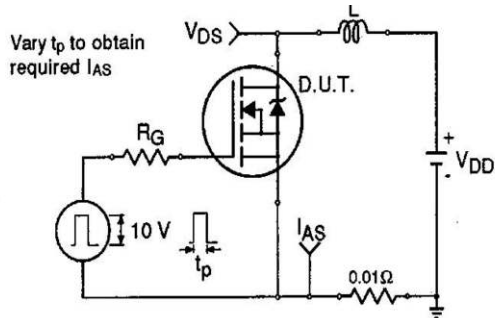
**Fig 10b. Switching Time Waveforms**



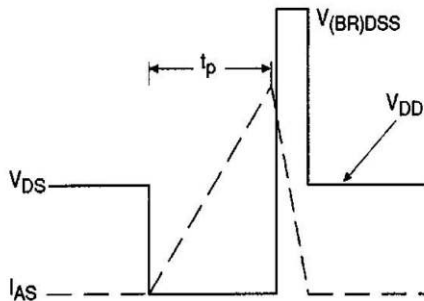
**Fig. 11 Maximum Effective Transient Thermal Impedance, Junction-to-Case**

# IRCZ44PbF

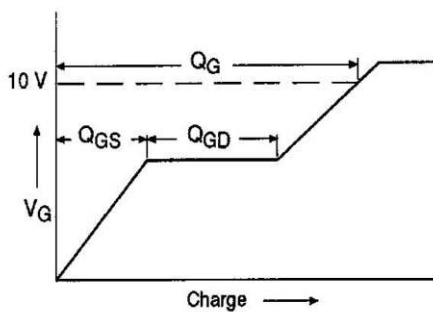
International  
**IR** Rectifier



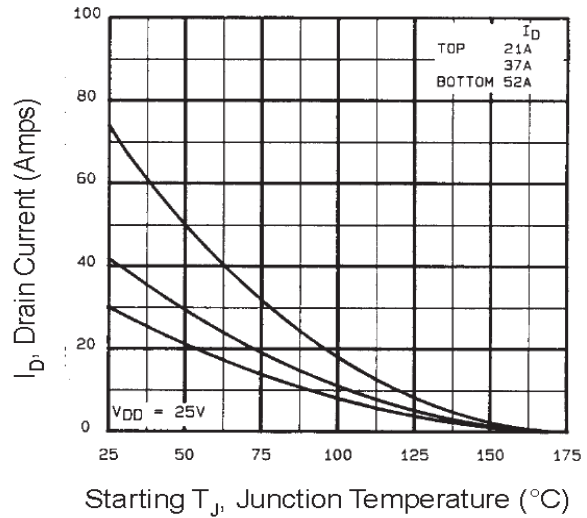
**Fig 12a.** Unclamped Inductive Test Circuit



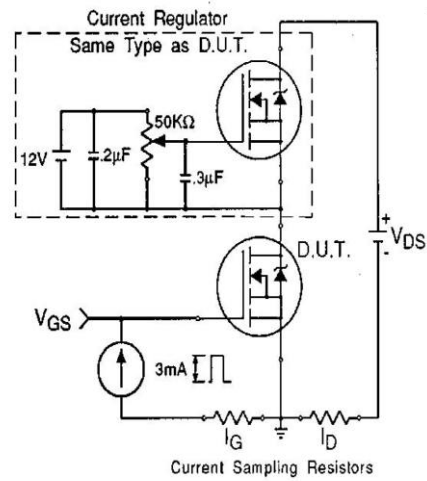
**Fig 12b.** Unclamped Inductive Waveforms



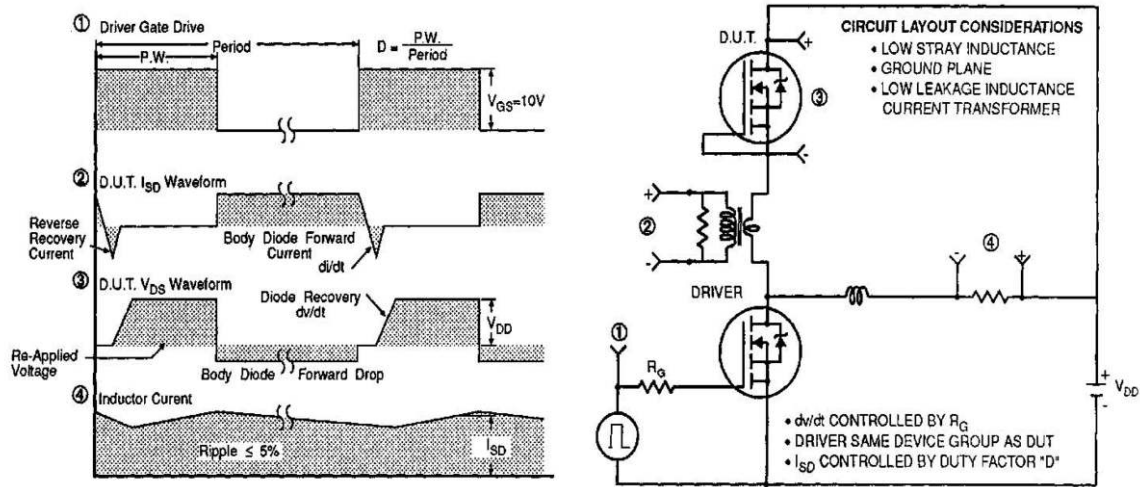
**Fig 13a.** Basic Gate Charge Waveform



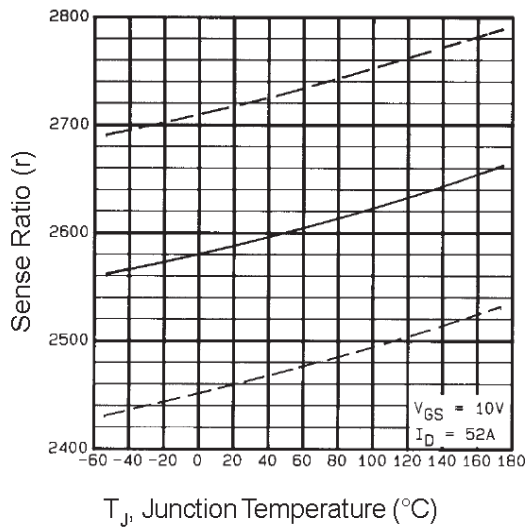
**Fig. 12c Maximum Avalanche Energy vs. Drain Current**



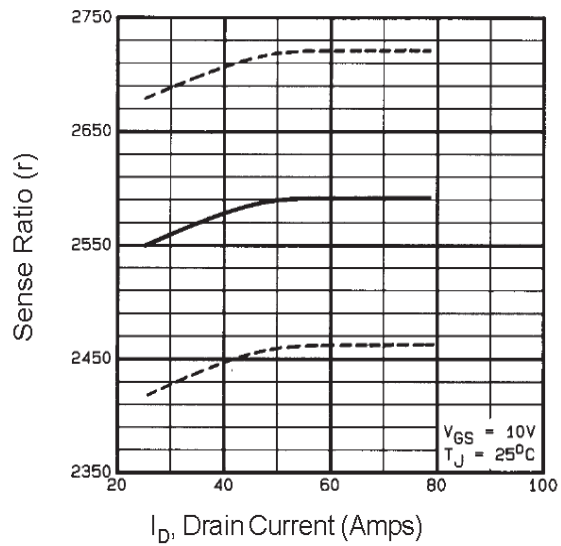
**Fig 13b.** Gate Charge Test Circuit



**Fig 14. Peak Diode Recovery  $dv/dt$  Test Circuit**

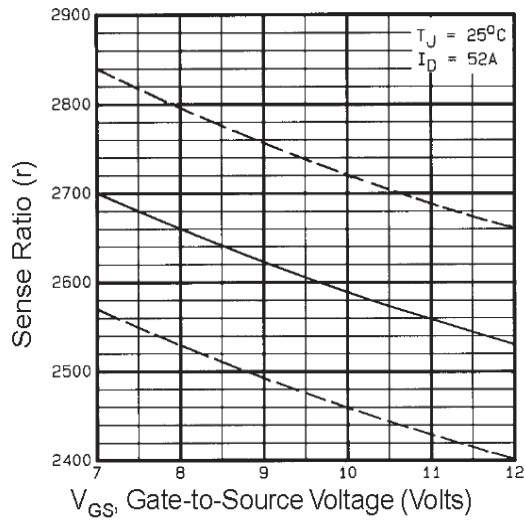


**Fig. 15 Typical HEXSense Ratio vs. Junction Temperature**

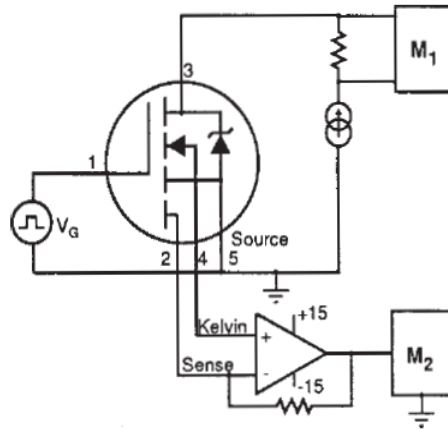


**Fig. 16 Typical HEXSense Ratio vs. Drain Current**

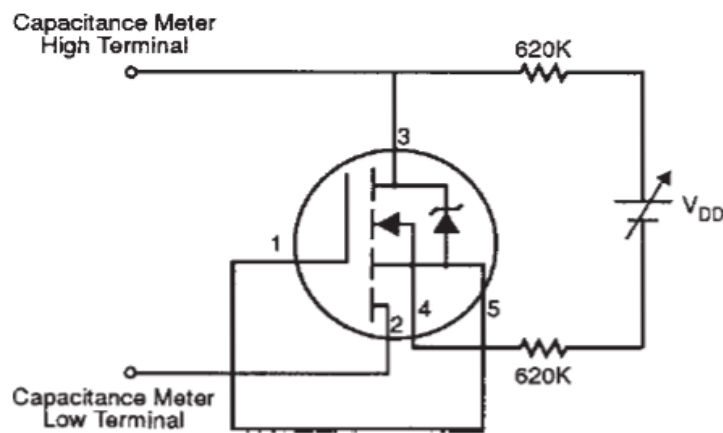
# IRCZ44PbF



**Fig. 17 Typical HEXSense Ratio vs. Gate Voltage**



**Fig. 18 HEXSense Ratio Test Circuit**

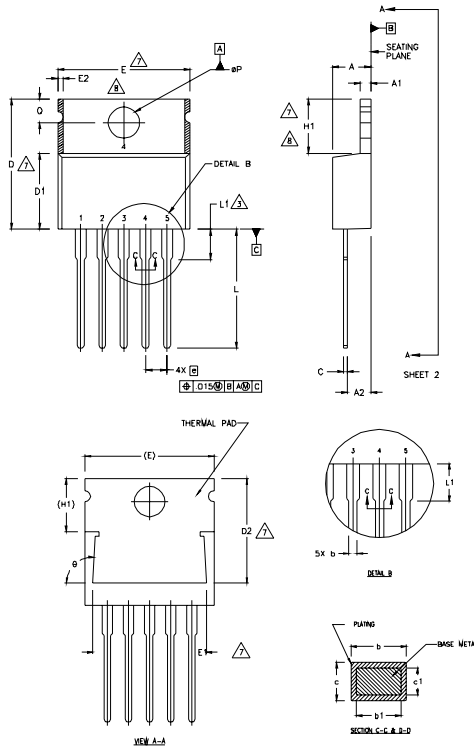


**Fig. 19 HEXSense Sensing Cell Output Capacitance Test Circuit**



## HexsenseTO-220 5L Package Outline

( Dimensions are shown in millimeters (inches) )



**NOTES:**

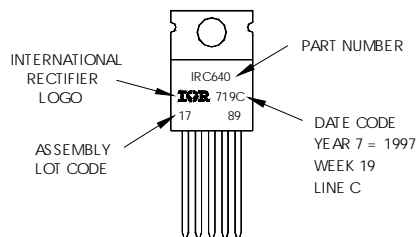
- 1 DIMENSIONING AND TOLERANCING PER ASME Y14.5 M- 1994.
- 2 DIMENSIONS ARE SHOWN IN INCHES [MILLIMETERS].
- 3 LEAD DIMENSION AND FINISH UNCONTROLLED IN L1.
- 4 DIMENSION D & E DO NOT INCLUDE MOLD FLASH. MOLD FLASH SHALL NOT EXCEED .005" (0.127) PER SIDE. THESE DIMENSIONS ARE MEASURED AT THE OUTERMOST EXTREMES OF THE PLASTIC BODY.
- 5 DIMENSION b1 & c1 APPLY TO BASE METAL ONLY.
- 6 CONTROLLING DIMENSION : INCHES.
- 7 THERMAL PAD CONTOUR OPTIONAL WITHIN DIMENSIONS E,H1,D2 & E1
- 8 DIMENSION E2 X H1 DEFINE A ZONE WHERE STAMPING AND SINGULATION IRREGULARITIES ARE ALLOWED.

SYMBOL	DIMENSIONS				NOTES
	MILLIMETERS		INCHES		
	MIN.	MAX.	MIN.	MAX.	
A	3.56	4.82	.140	.190	
A1	0.51	1.40	.020	.055	
A2	2.04	2.92	.080	.115	
b	0.64	0.88	.025	.035	
b1	0.64	0.84	.025	.033	5
c	0.36	0.61	.014	.024	
c1	0.36	0.56	.014	.022	5
D	14.22	16.51	.560	.650	4
D1	8.38	9.02	.330	.355	
D2	12.19	12.88	.480	.507	7
E	9.66	10.66	.380	.420	4,7
E1	8.38	8.89	.330	.350	7
e	1.70 BSC		.067 BSC		
H1	5.85	6.55	.230	.270	7,8
L	13.47	14.09	.530	.555	
L1	-	6.35	-	.250	3
ØP	3.54	4.08	.139	.161	
Q	2.54	3.42	.100	.135	
Ø	90°-93°		90°-93°		

## Hexsense TO-220 5L Part Marking Information

EXAMPLE: THIS IS AN IRC640  
 WITH ASSEMBLY  
 LOT CODE 1789  
 ASSEMBLED ON WW19, 1997  
 IN THE ASSEMBLY LINE "C"

Note: "P" in assembly line position  
 indicates "Lead-Free"



Data and specifications subject to change without notice.



## Notice

The products described herein were acquired by Vishay Intertechnology, Inc., as part of its acquisition of International Rectifier's Power Control Systems (PCS) business, which closed in April 2007. Specifications of the products displayed herein are pending review by Vishay and are subject to the terms and conditions shown below.

Specifications of the products displayed herein are subject to change without notice. Vishay Intertechnology, Inc., or anyone on its behalf, assumes no responsibility or liability for any errors or inaccuracies.

Information contained herein is intended to provide a product description only. No license, express or implied, by estoppel or otherwise, to any intellectual property rights is granted by this document. Except as provided in Vishay's terms and conditions of sale for such products, Vishay assumes no liability whatsoever, and disclaims any express or implied warranty, relating to sale and/or use of Vishay products including liability or warranties relating to fitness for a particular purpose, merchantability, or infringement of any patent, copyright, or other intellectual property right.

The products shown herein are not designed for use in medical, life-saving, or life-sustaining applications. Customers using or selling these products for use in such applications do so at their own risk and agree to fully indemnify Vishay for any damages resulting from such improper use or sale.

International Rectifier®, IR®, the IR logo, HEXFET®, HEXSense®, HEXDIP®, DOL®, INTERO®, and POWIRTRAIN® are registered trademarks of International Rectifier Corporation in the U.S. and other countries. All other product names noted herein may be trademarks of their respective owners.