

# TLC27M4, TLC27M4A, TLC27M4B, TLC27M4Y, TLC27M9 LinCMOS™ PRECISION QUAD OPERATIONAL AMPLIFIERS

SLOS093C – OCTOBER 1987 – REVISED MAY 1999

- **Trimmed Offset Voltage:**  
TLC27M9 . . . 900  $\mu\text{V}$  Max at  $T_A = 25^\circ\text{C}$ ,  
 $V_{DD} = 5\text{ V}$
- **Input Offset Voltage Drift . . . Typically**  
0.1  $\mu\text{V}/\text{Month}$ , Including the First 30 Days
- **Wide Range of Supply Voltages Over Specified Temperature Range:**  
0°C to 70°C . . . 3 V to 16 V  
–40°C to 85°C . . . 4 V to 16 V  
–55°C to 125°C . . . 4 V to 16 V
- **Single-Supply Operation**
- **Common-Mode Input Voltage Range Extends Below the Negative Rail (C-Suffix, I-Suffix Types)**
- **Low Noise . . . Typically 32 nV/ $\sqrt{\text{Hz}}$  at  $f = 1\text{ kHz}$**
- **Low Power . . . Typically 2.1 mW at  $T_A = 25^\circ\text{C}$ ,  $V_{DD} = 5\text{ V}$**
- **Output Voltage Range Includes Negative Rail**
- **High Input Impedance . . .  $10^{12}\ \Omega$  Typ**
- **ESD-Protection Circuitry**
- **Small-Outline Package Option Also Available in Tape and Reel**
- **Designed-In Latch-Up Immunity**

**D, J, N, OR PW PACKAGE  
(TOP VIEW)**

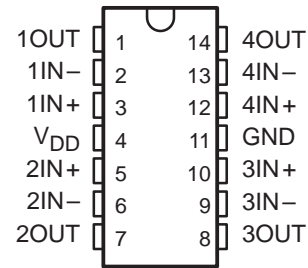

**FK PACKAGE  
(TOP VIEW)**

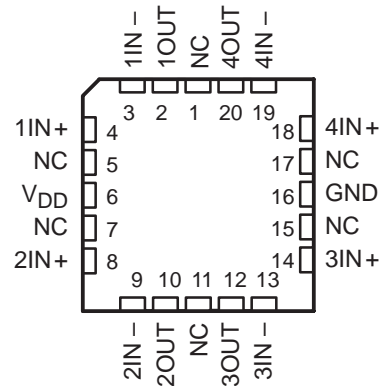

NC – No internal connection

## description

The TLC27M4 and TLC27M9 quad operational amplifiers combine a wide range of input offset voltage grades with low offset voltage drift, high input impedance, low noise, and speeds comparable to that of general-purpose bipolar devices. These devices use Texas Instruments silicon-gate LinCMOS™ technology, which provides offset voltage stability far exceeding the stability available with conventional metal-gate processes.

The extremely high input impedance, low bias currents, make these cost-effective devices ideal for applications that have previously been reserved for general-purpose bipolar products, but with only a fraction of the power consumption.

**DISTRIBUTION OF TLC27M9  
INPUT OFFSET VOLTAGE**

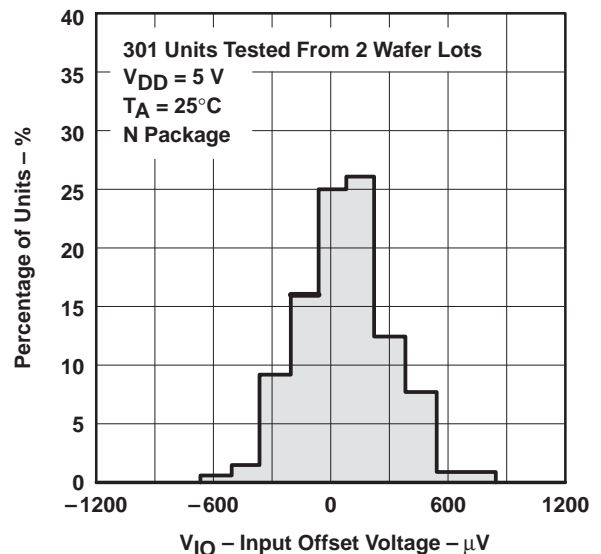

Please be aware that an important notice concerning availability, standard warranty, and use in critical applications of Texas Instruments semiconductor products and disclaimers thereto appears at the end of this data sheet.

LinCMOS is a trademark of Texas Instruments Incorporated.

PRODUCTION DATA information is current as of publication date. Products conform to specifications per the terms of Texas Instruments standard warranty. Production processing does not necessarily include testing of all parameters.

**TEXAS  
INSTRUMENTS**

POST OFFICE BOX 655303 • DALLAS, TEXAS 75265

Copyright © 1998, Texas Instruments Incorporated

# TLC27M4, TLC27M4A, TLC27M4B, TLC27M4Y, TLC27M9 LinCMOS™ PRECISION QUAD OPERATIONAL AMPLIFIERS

SLOS093C – OCTOBER 1987 – REVISED MAY 1999

## description (continued)

Four offset voltage grades are available (C-suffix and I-suffix types), ranging from the low-cost TLC27M4 (10 mV) to the high-precision TLC27M9 (900  $\mu$ V). These advantages, in combination with good common-mode rejection and supply voltage rejection, make these devices a good choice for new state-of-the-art designs as well as for upgrading existing designs.

In general, many features associated with bipolar technology are available on LinCMOS™ operational amplifiers, without the power penalties of bipolar technology. General applications such as transducer interfacing, analog calculations, amplifier blocks, active filters, and signal buffering are easily designed with the TLC27M4 and TLC27M9. The devices also exhibit low voltage single-supply operation, and low power consumption, making them ideally suited for remote and inaccessible battery-powered applications. The common-mode input voltage range includes the negative rail.

A wide range of packaging options is available, including small-outline and chip-carrier versions for high-density system applications.

The device inputs and outputs are designed to withstand –100-mA surge currents without sustaining latch-up.

The TLC27M4 and TLC27M9 incorporate internal ESD-protection circuits that prevent functional failures at voltages up to 2000 V as tested under MIL-STD-883C, Method 3015; however, care should be exercised in handling these devices, as exposure to ESD may result in the degradation of the device parametric performance.

The C-suffix devices are characterized for operation from 0°C to 70°C. The I-suffix devices are characterized for operation from –40°C to 85°C. The M-suffix devices are characterized for operation over the full military temperature range of –55°C to 125°C.

### AVAILABLE OPTIONS

T <sub>A</sub>	V <sub>IOmax</sub> AT 25°C	PACKAGE					CHIP FORM (Y)
		SMALL OUTLINE (D)	CHIP CARRIER (FK)	CERAMIC DIP (J)	PLASTIC DIP (N)	TSSOP (PW)	
0°C to 70°C	900 $\mu$ V	TLC27M9CD	—	—	TLC27M9CN	—	—
	2 mV	TLC27M4BCD	—	—	TLC27M4BCN	—	—
	5 mV	TLC27M4ACD	—	—	TLC27M4ACN	—	—
	10 mV	TLC27M4CD	—	—	TLC27M4CN	TLC27M4CPW	TLC27M4Y
–40°C to 85°C	900 $\mu$ V	TLC27M9ID	—	—	TLC27M9IN	—	—
	2 mV	TLC27M4BID	—	—	TLC27M4BIN	—	—
	5 mV	TLC27M4AID	—	—	TLC27M4AIN	—	—
	10 mV	TLC27M4ID	—	—	TLC27M4IN	TLC27M41PW	—
–55°C to 125°C	900 $\mu$ V	TLC27M9MD	TLC27M9MFK	TLC27M9MJ	TLC27M9MN	—	—
	10 mV	TLC27M4MD	TLC27M4MFK	TLC27M4MJ	TLC27M4MN	—	—

The D and PW package is available taped and reeled. Add R suffix to the device type (e.g., TLC279CDR).



POST OFFICE BOX 655303 • DALLAS, TEXAS 75265

equivalent schematic (each amplifier)

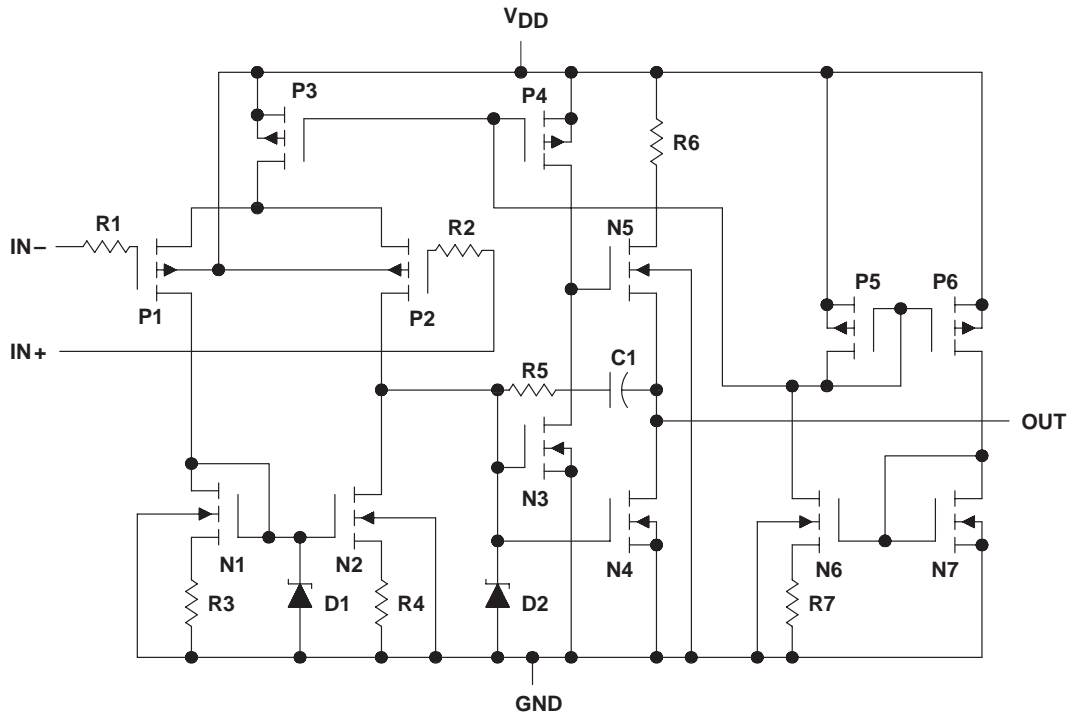

# TLC27M4, TLC27M4A, TLC27M4B, TLC27M4Y, TLC27M9 LinCMOS™ PRECISION QUAD OPERATIONAL AMPLIFIERS

SLOS093C – OCTOBER 1987 – REVISED MAY 1999

## TLC27M4Y chip information

This chip, when properly assembled, displays characteristics similar to the TLC27M4C. Thermal compression or ultrasonic bonding may be used on the doped-aluminum bonding pads. Chips may be mounted with conductive epoxy or a gold-silicon preform.

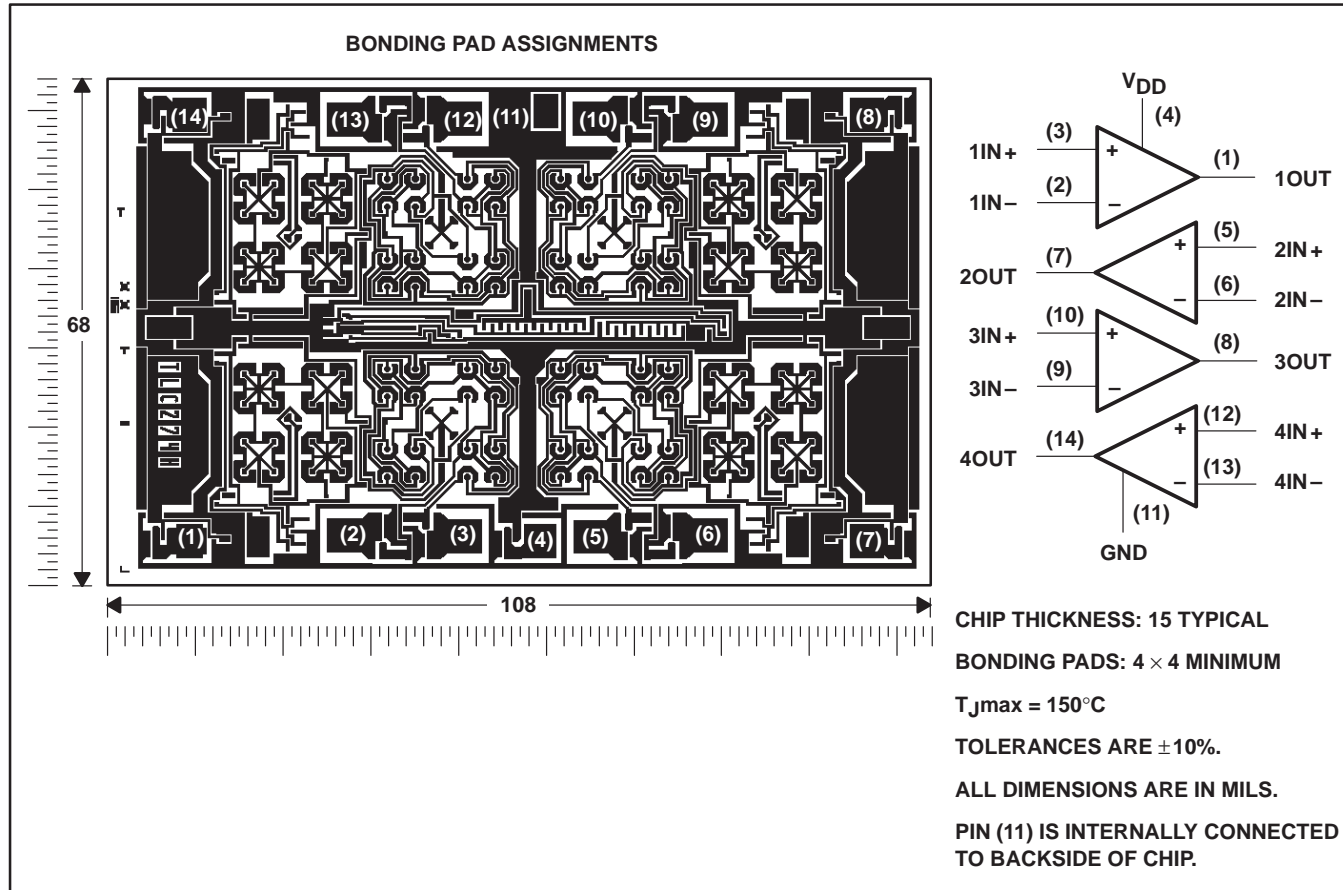

# TLC27M4, TLC27M4A, TLC27M4B, TLC27M4Y, TLC27M9 LinCMOS™ PRECISION QUAD OPERATIONAL AMPLIFIERS

SLOS093C – OCTOBER 1987 – REVISED MAY 1999

## absolute maximum ratings over operating free-air temperature range (unless otherwise noted)†

Supply voltage, $V_{DD}$ (see Note 1)	18 V
Differential input voltage, $V_{ID}$ (see Note 2)	$\pm V_{DD}$
Input voltage range, $V_I$ (any input)	-0.3 V to $V_{DD}$
Input current, $I_I$	$\pm 5$ mA
Output current, $I_O$ (each output)	$\pm 30$ mA
Total current into $V_{DD}$	45 mA
Total current out of GND	45 mA
Duration of short-circuit current at (or below) 25°C (see Note 3)	unlimited
Continuous total dissipation	See Dissipation Rating Table
Operating free-air temperature, $T_A$ : C suffix	0°C to 70°C
I suffix	-40°C to 85°C
M suffix	-55°C to 125°C
Storage temperature range	-65°C to 150°C
Case temperature for 60 seconds: FK package	260°C
Lead temperature 1,6 mm (1/16 inch) from case for 10 seconds: D, N, or PW package	260°C
Lead temperature 1,6 mm (1/16 inch) from case for 60 seconds: J package	300°C

† Stresses beyond those listed under “absolute maximum ratings” may cause permanent damage to the device. These are stress ratings only, and functional operation of the device at these or any other conditions beyond those indicated under “recommended operating conditions” is not implied. Exposure to absolute-maximum-rated conditions for extended periods may affect device reliability.

- NOTES:
1. All voltage values, except differential voltages, are with respect to network ground.
  2. Differential voltages are at  $IN+$  with respect to  $IN-$ .
  3. The output may be shorted to either supply. Temperature and/or supply voltages must be limited to ensure that the maximum dissipation rating is not exceeded (see application section).

DISSIPATION RATING TABLE

PACKAGE	$T_A \leq 25^\circ\text{C}$ POWER RATING	DERATING FACTOR ABOVE $T_A = 25^\circ\text{C}$	$T_A = 70^\circ\text{C}$ POWER RATING	$T_A = 85^\circ\text{C}$ POWER RATING	$T_A = 125^\circ\text{C}$ POWER RATING
D	950 mW	7.6 mW/°C	608 mW	494 mW	—
FK	1375 mW	11.0 mW/°C	880 mW	715 mW	275 mW
J	1375 mW	11.0 mW/°C	880 mW	715 mW	275 mW
N	1575 mW	12.6 mW/°C	1008 mW	819 mW	—
PW	700 mW	5.6 mW/°C	448 mW	—	—

## recommended operating conditions

	C SUFFIX		I SUFFIX		M SUFFIX		UNIT
	MIN	MAX	MIN	MAX	MIN	MAX	
Supply voltage, $V_{DD}$	3	16	4	16	4	16	V
Common-mode input voltage, $V_{IC}$	$V_{DD} = 5$ V		-0.2	3.5	-0.2	3.5	V
	$V_{DD} = 10$ V		-0.2	8.5	-0.2	8.5	
Operating free-air temperature, $T_A$	0	70	-40	85	-55	125	°C



# TLC27M4, TLC27M4A, TLC27M4B, TLC27M4Y, TLC27M9 LinCMOS™ PRECISION QUAD OPERATIONAL AMPLIFIERS

SLOS093C – OCTOBER 1987 – REVISED MAY 1999

electrical characteristics at specified free-air temperature,  $V_{DD} = 5\text{ V}$  (unless otherwise noted)

PARAMETER		TEST CONDITIONS		$T_A$ †	TLC27M4C TLC27M4AC TLC27M4BC TLC27M9C			UNIT
					MIN	TYP	MAX	
$V_{IO}$	Input offset voltage	TLC27M4C	$V_O = 1.4\text{ V}$ , $R_S = 50\ \Omega$ ,	$V_{IC} = 0$ , $R_L = 100\text{ k}\Omega$	25°C	1.1	10	mV
					Full range		12	
		TLC27M4AC	$V_O = 1.4\text{ V}$ , $R_S = 50\ \Omega$ ,	$V_{IC} = 0$ , $R_L = 100\text{ k}\Omega$	25°C	0.9	5	
					Full range		6.5	
	TLC274BC	$V_O = 1.4\text{ V}$ , $R_S = 50\ \Omega$ ,	$V_{IC} = 0$ , $R_L = 100\text{ k}\Omega$	25°C	250	2000	$\mu\text{V}$	
				Full range		3000		
	TLC279C	$V_O = 1.4\text{ V}$ , $R_S = 50\ \Omega$ ,	$V_{IC} = 0$ , $R_L = 100\text{ k}\Omega$	25°C	210	900		
				Full range		1500		
$\alpha_{VIO}$	Average temperature coefficient of input offset voltage			25°C to 70°C	1.7		$\mu\text{V}/^\circ\text{C}$	
$I_{IO}$	Input offset current (see Note 4)	$V_O = 2.5\text{ V}$ ,	$V_{IC} = 2.5\text{ V}$	25°C	0.1		pA	
				70°C	7	300		
$I_{IB}$	Input bias current (see Note 4)	$V_O = 2.5\text{ V}$ ,	$V_{IC} = 2.5\text{ V}$	25°C	0.6		pA	
				70°C	40	600		
$V_{ICR}$	Common-mode input voltage range (see Note 5)			25°C	-0.2 to 4	-0.3 to 4.2	V	
				Full range	-0.2 to 3.5		V	
$V_{OH}$	High-level output voltage	$V_{ID} = 100\text{ mV}$ ,	$R_L = 100\text{ k}\Omega$	25°C	3.2	3.9	V	
				0°C	3	3.9		
				70°C	3	4		
$V_{OL}$	Low-level output voltage	$V_{ID} = -100\text{ mV}$ ,	$I_{OL} = 0$	25°C	0	50	mV	
				0°C	0	50		
				70°C	0	50		
$A_{VD}$	Large-signal differential voltage amplification	$V_O = 0.25\text{ V to }2\text{ V}$ ,	$R_L = 100\text{ k}\Omega$	25°C	25	170	V/mV	
				0°C	15	200		
				70°C	15	140		
CMRR	Common-mode rejection ratio	$V_{IC} = V_{ICRmin}$		25°C	65	91	dB	
				0°C	60	91		
				70°C	60	92		
$k_{SVR}$	Supply-voltage rejection ratio ( $\Delta V_{DD}/\Delta V_{IO}$ )	$V_{DD} = 5\text{ V to }10\text{ V}$ ,	$V_O = 1.4\text{ V}$	25°C	70	93	dB	
				0°C	60	92		
				70°C	60	94		
$I_{DD}$	Supply current (four amplifiers)	$V_O = 2.5\text{ V}$ , No load	$V_{IC} = 2.5\text{ V}$ ,	25°C	420	1120	$\mu\text{A}$	
				0°C	500	1280		
				70°C	340	880		

† Full range is 0°C to 70°C.

NOTES: 4. The typical values of input bias current and input offset current below 5 pA were determined mathematically.  
5. This range also applies to each input individually.



# TLC27M4, TLC27M4A, TLC27M4B, TLC27M4Y, TLC27M9 LinCMOS™ PRECISION QUAD OPERATIONAL AMPLIFIERS

SLOS093C – OCTOBER 1987 – REVISED MAY 1999

**electrical characteristics at specified free-air temperature,  $V_{DD} = 10\text{ V}$  (unless otherwise noted)**

PARAMETER		TEST CONDITIONS		$T_A$ †	TLC27M4C TLC27M4AC TLC27M4BC TLC27M9C			UNIT
					MIN	TYP	MAX	
$V_{IO}$	Input offset voltage	TLC27M4C	$V_O = 1.4\text{ V}$ , $R_S = 50\ \Omega$ ,	$V_{IC} = 0$ , $R_L = 100\text{ k}\Omega$	25°C	1.1	10	mV
					Full range		12	
		TLC27M4AC	$V_O = 1.4\text{ V}$ , $R_S = 50\ \Omega$ ,	$V_{IC} = 0$ , $R_L = 100\text{ k}\Omega$	25°C	0.9	5	mV
					Full range		6.5	
		TLC27M4BC	$V_O = 1.4\text{ V}$ , $R_S = 50\ \Omega$ ,	$V_{IC} = 0$ , $R_L = 100\text{ k}\Omega$	25°C	260	2000	$\mu\text{V}$
					Full range		3000	
		TLC27M9C	$V_O = 1.4\text{ V}$ , $R_S = 50\ \Omega$ ,	$V_{IC} = 0$ , $R_L = 100\text{ k}\Omega$	25°C	220	1200	$\mu\text{V}$
					Full range		1900	
$\alpha_{VIO}$	Average temperature coefficient of input offset voltage			25°C to 70°C	2.1		$\mu\text{V}/^\circ\text{C}$	
$I_{IO}$	Input offset current (see Note 4)	$V_O = 5\text{ V}$ ,	$V_{IC} = 5\text{ V}$	25°C	0.1		pA	
				70°C	7	300		
$I_{IB}$	Input bias current (see Note 4)	$V_O = 5\text{ V}$ ,	$V_{IC} = 5\text{ V}$	25°C	0.7		pA	
				70°C	50	600		
$V_{ICR}$	Common-mode input voltage range (see Note 5)			25°C	-0.2 to 9	-0.3 to 9.2	V	
				Full range	-0.2 to 8.5		V	
$V_{OH}$	High-level output voltage	$V_{ID} = 100\text{ mV}$ ,	$R_L = 100\text{ k}\Omega$	25°C	8	8.7	V	
				0°C	7.8	8.7		
				70°C	7.8	8.7		
$V_{OL}$	Low-level output voltage	$V_{ID} = -100\text{ mV}$ ,	$I_{OL} = 0$	25°C	0	50	mV	
				0°C	0	50		
				70°C	0	50		
$A_{VD}$	Large-signal differential voltage amplification	$V_O = 1\text{ V to }6\text{ V}$ ,	$R_L = 100\text{ k}\Omega$	25°C	25	275	V/mV	
				0°C	15	320		
				70°C	15	230		
CMRR	Common-mode rejection ratio	$V_{IC} = V_{ICRmin}$		25°C	65	94	dB	
				0°C	60	94		
				70°C	60	94		
$k_{SVR}$	Supply-voltage rejection ratio ( $\Delta V_{DD}/\Delta V_{IO}$ )	$V_{DD} = 5\text{ V to }10\text{ V}$ ,	$V_O = 1.4\text{ V}$	25°C	70	93	dB	
				0°C	60	92		
				70°C	60	94		
$I_{DD}$	Supply current (four amplifiers)	$V_O = 5\text{ V}$ , No load	$V_{IC} = 5\text{ V}$ ,	25°C	570	1200	$\mu\text{A}$	
				0°C	690	1600		
				70°C	440	1120		

† Full range is 0°C to 70°C.

- NOTES: 4. The typical values of input bias current and input offset current below 5 pA were determined mathematically.  
5. This range also applies to each input individually.



# TLC27M4, TLC27M4A, TLC27M4B, TLC27M4Y, TLC27M9 LinCMOS™ PRECISION QUAD OPERATIONAL AMPLIFIERS

SLOS093C – OCTOBER 1987 – REVISED MAY 1999

electrical characteristics at specified free-air temperature,  $V_{DD} = 5\text{ V}$  (unless otherwise noted)

PARAMETER		TEST CONDITIONS		$T_A$ †	TLC27M4I TLC27M4AI TLC27M4BI TLC27M9I			UNIT
					MIN	TYP	MAX	
$V_{IO}$	Input offset voltage	TLC27M4I	$V_O = 1.4\text{ V}$ , $R_S = 50\ \Omega$	$V_{IC} = 0$ , $R_L = 100\text{ k}\Omega$	25°C	1.1 10		mV
					Full range	13		
		TLC27M4AI	$V_O = 1.4\text{ V}$ , $R_S = 50\ \Omega$	$V_{IC} = 0$ , $R_L = 100\text{ k}\Omega$	25°C	0.9 5		
					Full range	6.5		
	TLC27M4BI	$V_O = 1.4\text{ V}$ , $R_S = 50\ \Omega$	$V_{IC} = 0$ , $R_L = 100\text{ k}\Omega$	25°C	250	2000	$\mu\text{V}$	
				Full range	3000			
	TLC27M9I	$V_O = 1.4\text{ V}$ , $R_S = 50\ \Omega$	$V_{IC} = 0$ , $R_L = 100\text{ k}\Omega$	25°C	210	900		
				Full range	2000			
$\alpha_{VIO}$	Average temperature coefficient of input offset voltage			25°C to 85°C	1.7		$\mu\text{V}/^\circ\text{C}$	
$I_{IO}$	Input offset current (see Note 4)	$V_O = 2.5\text{ V}$	$V_{IC} = 2.5\text{ V}$	25°C	0.1		pA	
				85°C	24	1000		
$I_{IB}$	Input bias current (see Note 4)	$V_O = 2.5\text{ V}$	$V_{IC} = 2.5\text{ V}$	25°C	0.6		pA	
				85°C	200	2000		
$V_{ICR}$	Common-mode input voltage range (see Note 5)			25°C	-0.2 to 4	-0.3 to 4.2	V	
				Full range	-0.2 to 3.5		V	
$V_{OH}$	High-level output voltage	$V_{ID} = 100\text{ mV}$	$R_L = 100\text{ k}\Omega$	25°C	3.2	3.9	V	
				-40°C	3	3.9		
				85°C	3	4		
$V_{OL}$	Low-level output voltage	$V_{ID} = -100\text{ mV}$	$I_{OL} = 0$	25°C	0	50	mV	
				-40°C	0	50		
				85°C	0	50		
$A_{VD}$	Large-signal differential voltage amplification	$V_O = 0.25\text{ V to }2\text{ V}$	$R_L = 100\text{ k}\Omega$	25°C	25	170	V/mV	
				-40°C	15	270		
				85°C	15	130		
CMRR	Common-mode rejection ratio	$V_{IC} = V_{ICRmin}$		25°C	65	91	dB	
				-40°C	60	90		
				85°C	60	90		
$k_{SVR}$	Supply-voltage rejection ratio ( $\Delta V_{DD}/\Delta V_{IO}$ )	$V_{DD} = 5\text{ V to }10\text{ V}$	$V_O = 1.4\text{ V}$	25°C	70	93	dB	
				-40°C	60	91		
				85°C	60	94		
$I_{DD}$	Supply current (four amplifiers)	$V_O = 2.5\text{ V}$ , No load	$V_{IC} = 2.5\text{ V}$	25°C	420	1120	$\mu\text{A}$	
				-40°C	630	1600		
				85°C	320	800		

† Full range is -40°C to 85°C.

NOTES: 4. The typical values of input bias current and input offset current below 5 pA were determined mathematically.  
5. This range also applies to each input individually.





# TLC27M4, TLC27M4A, TLC27M4B, TLC27M4Y, TLC27M9 LinCMOS™ PRECISION QUAD OPERATIONAL AMPLIFIERS

SLOS093C – OCTOBER 1987 – REVISED MAY 1999

**electrical characteristics at specified free-air temperature,  $V_{DD} = 10\text{ V}$  (unless otherwise noted)**

PARAMETER		TEST CONDITIONS		$T_A$ †	TLC27M4I TLC27M4AI TLC27M4BI TLC27M9I			UNIT
					MIN	TYP	MAX	
$V_{IO}$	Input offset voltage	TLC27M4I	$V_O = 1.4\text{ V}$ , $R_S = 50\ \Omega$	$V_{IC} = 0$ , $R_L = 100\text{ k}\Omega$	25°C	1.1	10	mV
					Full range		13	
		TLC27M4AI	$V_O = 1.4\text{ V}$ , $R_S = 50\ \Omega$	$V_{IC} = 0$ , $R_L = 100\text{ k}\Omega$	25°C	0.9	5	mV
					Full range		7	
		TLC27M4BI	$V_O = 1.4\text{ V}$ , $R_S = 50\ \Omega$	$V_{IC} = 0$ , $R_L = 100\text{ k}\Omega$	25°C	260	2000	$\mu\text{V}$
					Full range		3500	
		TLC27M9I	$V_O = 1.4\text{ V}$ , $R_S = 50\ \Omega$	$V_{IC} = 0$ , $R_L = 100\text{ k}\Omega$	25°C	220	1200	$\mu\text{V}$
					Full range		2900	
$\alpha_{VIO}$	Average temperature coefficient of input offset voltage			25°C to 85°C	2.1		$\mu\text{V}/^\circ\text{C}$	
$I_{IO}$	Input offset current (see Note 4)	$V_O = 5\text{ V}$ ,	$V_{IC} = 5\text{ V}$	25°C	0.1		pA	
				85°C	26	1000		
$I_{IB}$	Input bias current (see Note 4)	$V_O = 5\text{ V}$ ,	$V_{IC} = 5\text{ V}$	25°C	0.7		pA	
				85°C	220	2000		
$V_{ICR}$	Common-mode input voltage range (see Note 5)			25°C	-0.2 to 9	-0.3 to 9.2	V	
				Full range	-0.2 to 8.5		V	
$V_{OH}$	High-level output voltage	$V_{ID} = 100\text{ mV}$ ,	$R_L = 100\text{ k}\Omega$	25°C	8	8.7	V	
				-40°C	7.8	8.7		
				85°C	7.8	8.7		
$V_{OL}$	Low-level output voltage	$V_{ID} = -100\text{ mV}$ ,	$I_{OL} = 0$	25°C	0	50	mV	
				-40°C	0	50		
				85°C	0	50		
$A_{VD}$	Large-signal differential voltage amplification	$V_O = 1\text{ V to }6\text{ V}$ ,	$R_L = 100\text{ k}\Omega$	25°C	25	275	V/mV	
				-40°C	15	390		
				85°C	15	220		
CMRR	Common-mode rejection ratio	$V_{IC} = V_{ICRmin}$		25°C	65	94	dB	
				-40°C	60	93		
				85°C	60	94		
$k_{SVR}$	Supply-voltage rejection ratio ( $\Delta V_{DD}/\Delta V_{IO}$ )	$V_{DD} = 5\text{ V to }10\text{ V}$ ,	$V_O = 1.4\text{ V}$	25°C	70	93	dB	
				-40°C	60	91		
				85°C	60	94		
$I_{DD}$	Supply current (four amplifiers)	$V_O = 5\text{ V}$ , No load	$V_{IC} = 5\text{ V}$ ,	25°C	570	1200	$\mu\text{A}$	
				-40°C	900	1800		
				85°C	410	1040		

† Full range is -40°C to 85°C.

- NOTES: 4. The typical values of input bias current and input offset current below 5 pA were determined mathematically.  
5. This range also applies to each input individually.



# TLC27M4, TLC27M4A, TLC27M4B, TLC27M4Y, TLC27M9 LinCMOS™ PRECISION QUAD OPERATIONAL AMPLIFIERS

SLOS093C – OCTOBER 1987 – REVISED MAY 1999

## electrical characteristics at specified free-air temperature, $V_{DD} = 5\text{ V}$ (unless otherwise noted)

PARAMETER		TEST CONDITIONS		$T_A$ †	TLC27M4M TLC27M9M			UNIT
					MIN	TYP	MAX	
$V_{IO}$	Input offset voltage	TLC27M4M	$V_O = 1.4\text{ V}$ , $R_S = 50\ \Omega$ ,	$V_{IC} = 0$ , $R_L = 100\text{ k}\Omega$	25°C	1.1	10	mV
					Full range		12	
		TLC27M9M	$V_O = 1.4\text{ V}$ , $R_S = 50\ \Omega$ ,	$V_{IC} = 0$ , $R_L = 100\text{ k}\Omega$	25°C	210	900	$\mu\text{V}$
					Full range		3750	
$\alpha_{VIO}$	Average temperature coefficient of input offset voltage			25°C to 125°C	1.7		$\mu\text{V}/^\circ\text{C}$	
$I_{IO}$	Input offset current (see Note 4)	$V_O = 2.5\text{ V}$ ,	$V_{IC} = 2.5\text{ V}$	25°C	0.1		pA	
				125°C	1.4	15	nA	
$I_{IB}$	Input bias current (see Note 4)	$V_O = 2.5\text{ V}$ ,	$V_{IC} = 2.5\text{ V}$	25°C	0.6		pA	
				125°C	9	35	nA	
$V_{ICR}$	Common-mode input voltage range (see Note 5)			25°C	0 to 4	-0.3 to 4.2	V	
				Full range	0 to 3.5		V	
$V_{OH}$	High-level output voltage	$V_{ID} = 100\text{ mV}$ ,	$R_L = 100\text{ k}\Omega$	25°C	3.2	3.9	V	
				-55°C	3	3.9		
				125°C	3	4		
$V_{OL}$	Low-level output voltage	$V_{ID} = -100\text{ mV}$ ,	$I_{OL} = 0$	25°C		0 50	mV	
				-55°C		0 50		
				125°C		0 50		
$A_{VD}$	Large-signal differential voltage amplification	$V_O = 0.25\text{ V to }2\text{ V}$ ,	$R_L = 100\text{ k}\Omega$	25°C	25	170	V/mV	
				-55°C	15	290		
				125°C	15	120		
CMRR	Common-mode rejection ratio	$V_{IC} = V_{ICRmin}$		25°C	65	91	dB	
				-55°C	60	89		
				125°C	60	91		
$k_{SVR}$	Supply-voltage rejection ratio ( $\Delta V_{DD}/\Delta V_{IO}$ )	$V_{DD} = 5\text{ V to }10\text{ V}$ ,	$V_O = 1.4\text{ V}$	25°C	70	93	dB	
				-55°C	60	91		
				125°C	60	94		
$I_{DD}$	Supply current (four amplifiers)	$V_O = 2.5\text{ V}$ , No load	$V_{IC} = 2.5\text{ V}$ ,	25°C	420	1120	$\mu\text{A}$	
				-55°C	680	1760		
				125°C	280	720		

† Full range is -55°C to 125°C.

NOTES: 4. The typical values of input bias current and input offset current below 5 pA were determined mathematically.

5. This range also applies to each input individually.



# TLC27M4, TLC27M4A, TLC27M4B, TLC27M4Y, TLC27M9 LinCMOS™ PRECISION QUAD OPERATIONAL AMPLIFIERS

SLOS093C – OCTOBER 1987 – REVISED MAY 1999

**electrical characteristics at specified free-air temperature,  $V_{DD} = 10\text{ V}$  (unless otherwise noted)**

PARAMETER		TEST CONDITIONS	$T_A$ †	TLC27M4M TLC27M9M			UNIT	
				MIN	TYP	MAX		
$V_{IO}$	Input offset voltage	$V_O = 1.4\text{ V}$ , $R_S = 50\ \Omega$ ,	$V_{IC} = 0$ , $R_L = 100\text{ k}\Omega$	25°C	1.1	10	mV	
				Full range		12		
		TLC27M9M	$V_O = 1.4\text{ V}$ , $R_S = 50\ \Omega$ ,	$V_{IC} = 0$ , $R_L = 100\text{ k}\Omega$	25°C	220	1200	$\mu\text{V}$
					Full range		4300	
$\alpha_{VIO}$	Average temperature coefficient of input offset voltage		25°C to 125°C	2.1		$\mu\text{V}/^\circ\text{C}$		
$I_{IO}$	Input offset current (see Note 4)	$V_O = 5\text{ V}$ ,	$V_{IC} = 5\text{ V}$	25°C	0.1		pA	
				125°C	1.8	15	nA	
$I_{IB}$	Input bias current (see Note 4)	$V_O = 5\text{ V}$ ,	$V_{IC} = 5\text{ V}$	25°C	0.7		pA	
				125°C	10	35	nA	
$V_{ICR}$	Common-mode input voltage range (see Note 5)			25°C	0 to 9	-0.3 to 9.2	V	
				Full range	0 to 8.5		V	
$V_{OH}$	High-level output voltage	$V_{ID} = 100\text{ mV}$ ,	$R_L = 100\text{ k}\Omega$	25°C	8	8.7	V	
				-55°C	7.8	8.6		
				125°C	7.8	8.8		
$V_{OL}$	Low-level output voltage	$V_{ID} = -100\text{ mV}$ ,	$I_{OL} = 0$	25°C	0	50	mV	
				-55°C	0	50		
				125°C	0	50		
$A_{VD}$	Large-signal differential voltage amplification	$V_O = 1\text{ V to }6\text{ V}$ ,	$R_L = 100\text{ k}\Omega$	25°C	25	275	V/mV	
				-55°C	15	420		
				125°C	15	190		
CMRR	Common-mode rejection ratio	$V_{IC} = V_{ICRmin}$		25°C	65	94	dB	
				-55°C	60	93		
				125°C	60	93		
$k_{SVR}$	Supply-voltage rejection ratio ( $\Delta V_{DD}/\Delta V_{IO}$ )	$V_{DD} = 5\text{ V to }10\text{ V}$ ,	$V_O = 1.4\text{ V}$	25°C	70	93	dB	
				-55°C	60	91		
				125°C	60	94		
$I_{DD}$	Supply current (four amplifiers)	$V_O = 5\text{ V}$ , No load	$V_{IC} = 5\text{ V}$ ,	25°C	570	1200	$\mu\text{A}$	
				-55°C	980	2000		
				125°C	360	960		

† Full range is -55°C to 125°C.

- NOTES: 4. The typical values of input bias current and input offset current below 5 pA were determined mathematically.  
5. This range also applies to each input individually.



# TLC27M4, TLC27M4A, TLC27M4B, TLC27M4Y, TLC27M9

## LinCMOS™ PRECISION QUAD OPERATIONAL AMPLIFIERS

SLOS093C – OCTOBER 1987 – REVISED MAY 1999

### electrical characteristics, $V_{DD} = 5\text{ V}$ , $T_A = 25^\circ\text{C}$ (unless otherwise noted)

PARAMETER	TEST CONDITIONS	TLC27M4Y			UNIT
		MIN	TYP	MAX	
$V_{IO}$ Input offset voltage	$V_O = 1.4\text{ V}$ , $R_S = 50\ \Omega$ , $V_{IC} = 0$ , $R_L = 100\ \text{k}\Omega$		1.1	10	mV
$\alpha_{VIO}$ Temperature coefficient of input offset voltage	$T_A = 25^\circ\text{C}$ to $70^\circ\text{C}$		1.7		$\mu\text{V}/^\circ\text{C}$
$I_{IO}$ Input offset current (see Note 4)	$V_O = 2.5\text{ V}$ , $V_{IC} = 2.5\text{ V}$		0.1		pA
$I_{IB}$ Input bias current (see Note 4)	$V_O = 2.5\text{ V}$ , $V_{IC} = 2.5\text{ V}$		0.6		pA
$V_{ICR}$ Common-mode input voltage range (see Note 5)		-0.2 to 4	-0.3 to 4.2		V
$V_{OH}$ High-level output voltage	$V_{ID} = 100\text{ mV}$ , $R_L = 100\ \text{k}\Omega$	3.2	3.9		V
$V_{OL}$ Low-level output voltage	$V_{ID} = -100\text{ mV}$ , $I_{OL} = 0$		0	50	mV
$A_{VD}$ Large-signal differential voltage amplification	$V_O = 0.25\text{ V}$ to $2\text{ V}$ , $R_L = 100\ \text{k}\Omega$	25	170		V/mV
CMRR Common-mode rejection ratio	$V_{IC} = V_{ICRmin}$	65	91		dB
$k_{SVR}$ Supply-voltage rejection ratio ( $\Delta V_{DD}/\Delta V_{IO}$ )	$V_{DD} = 5\text{ V}$ to $10\text{ V}$ , $V_O = 1.4\text{ V}$	70	93		dB
$I_{DD}$ Supply current (four amplifiers)	$V_O = 2.5\text{ V}$ , No load $V_{IC} = 2.5\text{ V}$		420	1120	$\mu\text{A}$

### electrical characteristics, $V_{DD} = 10\text{ V}$ , $T_A = 25^\circ\text{C}$ (unless otherwise noted)

PARAMETER	TEST CONDITIONS	TLC27M4Y			UNIT
		MIN	TYP	MAX	
$V_{IO}$ Input offset voltage	$V_O = 1.4\text{ V}$ , $R_S = 50\ \Omega$ , $V_{IC} = 0$ , $R_L = 100\ \text{k}\Omega$		1.1	10	mV
$\alpha_{VIO}$ Temperature coefficient of input offset voltage	$T_A = 25^\circ\text{C}$ to $70^\circ\text{C}$		2.1		$\mu\text{V}/^\circ\text{C}$
$I_{IO}$ Input offset current (see Note 4)	$V_O = 5\text{ V}$ , $V_{IC} = 5\text{ V}$		0.1		pA
$I_{IB}$ Input bias current (see Note 4)	$V_O = 5\text{ V}$ , $V_{IC} = 5\text{ V}$		0.7		pA
$V_{ICR}$ Common-mode input voltage range (see Note 5)		-0.2 to 9	-0.3 to 9.2		V
$V_{OH}$ High-level output voltage	$V_{ID} = 100\text{ mV}$ , $R_L = 100\ \text{k}\Omega$	8	8.7		V
$V_{OL}$ Low-level output voltage	$V_{ID} = -100\text{ mV}$ , $I_{OL} = 0$		0	50	mV
$A_{VD}$ Large-signal differential voltage amplification	$V_O = 1\text{ V}$ to $6\text{ V}$ , $R_L = 100\ \text{k}\Omega$	25	275		V/mV
CMRR Common-mode rejection ratio	$V_{IC} = V_{ICRmin}$	65	94		dB
$k_{SVR}$ Supply-voltage rejection ratio ( $\Delta V_{DD}/\Delta V_{IO}$ )	$V_{DD} = 5\text{ V}$ to $10\text{ V}$ , $V_O = 1.4\text{ V}$	70	93		dB
$I_{DD}$ Supply current (four amplifiers)	$V_O = 5\text{ V}$ , No load $V_{IC} = 5\text{ V}$		570	1200	$\mu\text{A}$

NOTES: 4. The typical values of input bias current and input offset current below 5 pA were determined mathematically.  
5. This range also applies to each input individually.



# TLC27M4, TLC27M4A, TLC27M4B, TLC27M4Y, TLC27M9 LinCMOS™ PRECISION QUAD OPERATIONAL AMPLIFIERS

SLOS093C – OCTOBER 1987 – REVISED MAY 1999

## operating characteristics at specified free-air temperature, $V_{DD} = 5\text{ V}$

PARAMETER	TEST CONDITIONS		$T_A$	TLC27M4C TLC27M4AC TLC27M4BC TLC27M9C			UNIT
				MIN	TYP	MAX	
SR Slew rate at unity gain	$R_L = 100\ \Omega$ , $C_L = 20\ \text{pF}$ , See Figure 1	$V_{IPP} = 1\ \text{V}$	25°C	0.43		V/ $\mu\text{s}$	
			0°C	0.46			
			70°C	0.36			
		$V_{IPP} = 2.5\ \text{V}$	25°C	0.40			
			0°C	0.43			
			70°C	0.34			
$V_n$ Equivalent input noise voltage	$f = 1\ \text{kHz}$ , See Figure 2	$R_S = 20\ \Omega$	25°C	32		nV/ $\sqrt{\text{Hz}}$	
$B_{OM}$ Maximum output-swing bandwidth	$V_O = V_{OH}$ , $R_L = 100\ \text{k}\Omega$ ,	$C_L = 20\ \text{pF}$ , See Figure 1	25°C	55		kHz	
			0°C	60			
			70°C	50			
$B_1$ Unity-gain bandwidth	$V_I = 10\ \text{mV}$ , See Figure 3	$C_L = 20\ \text{pF}$ ,	25°C	525		kHz	
			0°C	610			
			70°C	400			
$\phi_m$ Phase margin	$V_I = 10\ \text{mV}$ , $C_L = 20\ \text{pF}$ ,	$f = B_1$ , See Figure 3	25°C	40°			
			0°C	41°			
			70°C	39°			

## operating characteristics at specified free-air temperature, $V_{DD} = 10\ \text{V}$

PARAMETER	TEST CONDITIONS		$T_A$	TLC27M4C TLC27M4AC TLC27M4BC TLC27M9C			UNIT
				MIN	TYP	MAX	
SR Slew rate at unity gain	$R_L = 100\ \Omega$ , $C_L = 20\ \text{pF}$ , See Figure 1	$V_{IPP} = 1\ \text{V}$	25°C	0.62		V/ $\mu\text{s}$	
			0°C	0.67			
			70°C	0.51			
		$V_{IPP} = 5.5\ \text{V}$	25°C	0.56			
			0°C	0.61			
			70°C	0.46			
$V_n$ Equivalent input noise voltage	$f = 1\ \text{kHz}$ , See Figure 2	$R_S = 20\ \Omega$ ,	25°C	32		nV/ $\sqrt{\text{Hz}}$	
$B_{OM}$ Maximum output-swing bandwidth	$V_O = V_{OH}$ , $R_L = 100\ \text{k}\Omega$ ,	$C_L = 20\ \text{pF}$ , See Figure 1	25°C	35		kHz	
			0°C	40			
			70°C	30			
$B_1$ Unity-gain bandwidth	$V_I = 10\ \text{mV}$ , See Figure 3	$C_L = 20\ \text{pF}$ ,	25°C	635		kHz	
			0°C	710			
			70°C	510			
$\phi_m$ Phase margin	$V_I = 10\ \text{mV}$ , $C_L = 20\ \text{pF}$ ,	$f = B_1$ , See Figure 3	25°C	43°			
			0°C	44°			
			70°C	42°			



# TLC27M4, TLC27M4A, TLC27M4B, TLC27M4Y, TLC27M9 LinCMOS™ PRECISION QUAD OPERATIONAL AMPLIFIERS

SLOS093C – OCTOBER 1987 – REVISED MAY 1999

## operating characteristics at specified free-air temperature, $V_{DD} = 5\text{ V}$

PARAMETER	TEST CONDITIONS		$T_A$	TLC27M4I TLC27M4AI TLC27M4BI TLC27M9I			UNIT
				MIN	TYP	MAX	
SR Slew rate at unity gain	$R_L = 100\ \Omega$ , $C_L = 20\ \text{pF}$ , See Figure 1	$V_{I\text{PP}} = 1\ \text{V}$	25°C	0.43		V/ $\mu\text{s}$	
			-40°C	0.51			
			85°C	0.35			
		$V_{I\text{PP}} = 2.5\ \text{V}$	25°C	0.40			
			-40°C	0.48			
			85°C	0.32			
$V_n$ Equivalent input noise voltage	$f = 1\ \text{kHz}$ , See Figure 2	$R_S = 20\ \Omega$ ,	25°C	32		nV/ $\sqrt{\text{Hz}}$	
$B_{\text{OM}}$ Maximum output-swing bandwidth	$V_O = V_{\text{OH}}$ , $R_L = 100\ \text{k}\Omega$ ,	$C_L = 20\ \text{pF}$ , See Figure 1	25°C	55		kHz	
			-40°C	75			
			85°C	45			
$B_1$ Unity-gain bandwidth	$V_I = 10\ \text{mV}$ , See Figure 3	$C_L = 20\ \text{pF}$ ,	25°C	525		kHz	
			-40°C	770			
			85°C	370			
$\phi_m$ Phase margin	$V_I = 10\ \text{mV}$ , $C_L = 20\ \text{pF}$ ,	$f = B_1$ , See Figure 3	25°C	40°			
			-40°C	43°			
			85°C	38°			

## operating characteristics at specified free-air temperature, $V_{DD} = 10\ \text{V}$

PARAMETER	TEST CONDITIONS		$T_A$	TLC27M4I TLC27M4AI TLC27M4BI TLC27M9I			UNIT
				MIN	TYP	MAX	
SR Slew rate at unity gain	$R_L = 100\ \Omega$ , $C_L = 20\ \text{pF}$ , See Figure 1	$V_{I\text{PP}} = 1\ \text{V}$	25°C	0.62		V/ $\mu\text{s}$	
			-40°C	0.77			
			85°C	0.47			
		$V_{I\text{PP}} = 5.5\ \text{V}$	25°C	0.56			
			-40°C	0.70			
			85°C	0.44			
$V_n$ Equivalent input noise voltage	$f = 1\ \text{kHz}$ , See Figure 2	$R_S = 20\ \Omega$ ,	25°C	32		nV/ $\sqrt{\text{Hz}}$	
$B_{\text{OM}}$ Maximum output-swing bandwidth	$V_O = V_{\text{OH}}$ , $R_L = 100\ \text{k}\Omega$ ,	$C_L = 20\ \text{pF}$ , See Figure 1	25°C	35		kHz	
			-40°C	45			
			85°C	25			
$B_1$ Unity-gain bandwidth	$V_I = 10\ \text{mV}$ , See Figure 3	$C_L = 20\ \text{pF}$ ,	25°C	635		kHz	
			-40°C	880			
			85°C	480			
$\phi_m$ Phase margin	$V_I = 10\ \text{mV}$ , $C_L = 20\ \text{pF}$ ,	$f = B_1$ , See Figure 3	25°C	43°			
			-40°C	46°			
			85°C	41°			



# TLC27M4, TLC27M4A, TLC27M4B, TLC27M4Y, TLC27M9 LinCMOS™ PRECISION QUAD OPERATIONAL AMPLIFIERS

SLOS093C – OCTOBER 1987 – REVISED MAY 1999

## operating characteristics at specified free-air temperature, $V_{DD} = 5\text{ V}$

PARAMETER	TEST CONDITIONS	$T_A$	TLC27M4M TLC27M9M			UNIT
			MIN	TYP	MAX	
SR    Slew rate at unity gain	$R_L = 100\ \Omega$ , $C_L = 20\ \text{pF}$ , See Figure 1	$V_{I\text{PP}} = 1\ \text{V}$	25°C	0.43		V/ $\mu\text{s}$
			-55°C	0.54		
			125°C	0.29		
		$V_{I\text{PP}} = 2.5\ \text{V}$	25°C	0.40		
			-55°C	0.50		
			125°C	0.28		
$V_n$ Equivalent input noise voltage	$f = 1\ \text{kHz}$ , See Figure 2	$R_S = 20\ \Omega$ , 25°C	32		nV/ $\sqrt{\text{Hz}}$	
$B_{\text{OM}}$ Maximum output-swing bandwidth	$V_O = V_{\text{OH}}$ , $R_L = 100\ \text{k}\Omega$ ,	$C_L = 20\ \text{pF}$ , See Figure 1	25°C	55		kHz
			-55°C	80		
			125°C	40		
$B_1$ Unity-gain bandwidth	$V_I = 10\ \text{mV}$ , See Figure 3	$C_L = 20\ \text{pF}$ ,	25°C	525		kHz
			-55°C	850		
			125°C	330		
$\phi_m$ Phase margin	$V_I = 10\ \text{mV}$ , $C_L = 20\ \text{pF}$ ,	$f = B_1$ , See Figure 3	25°C	40°		
			-55°C	44°		
			125°C	36°		

## operating characteristics at specified free-air temperature, $V_{DD} = 10\ \text{V}$

PARAMETER	TEST CONDITIONS	$T_A$	TLC27M4M TLC27M9M			UNIT
			MIN	TYP	MAX	
SR    Slew rate at unity gain	$R_L = 100\ \Omega$ , $C_L = 20\ \text{pF}$ , See Figure 1	$V_{I\text{PP}} = 1\ \text{V}$	25°C	0.62		V/ $\mu\text{s}$
			-55°C	0.81		
			125°C	0.38		
		$V_{I\text{PP}} = 5.5\ \text{V}$	25°C	0.56		
			-55°C	0.73		
			125°C	0.35		
$V_n$ Equivalent input noise voltage	$f = 1\ \text{kHz}$ , See Figure 2	$R_S = 20\ \Omega$ , 25°C	32		nV/ $\sqrt{\text{Hz}}$	
$B_{\text{OM}}$ Maximum output-swing bandwidth	$V_O = V_{\text{OH}}$ , $R_L = 100\ \text{k}\Omega$ ,	$C_L = 20\ \text{pF}$ , See Figure 1	25°C	35		kHz
			-55°C	50		
			125°C	20		
$B_1$ Unity-gain bandwidth	$V_I = 10\ \text{mV}$ , See Figure 3	$C_L = 20\ \text{pF}$ ,	25°C	635		kHz
			-55°C	960		
			125°C	440		
$\phi_m$ Phase margin	$V_I = 10\ \text{mV}$ , $C_L = 20\ \text{pF}$ ,	$f = B_1$ , See Figure 3	25°C	43°		
			-55°C	47°		
			125°C	39°		



# TLC27M4, TLC27M4A, TLC27M4B, TLC27M4Y, TLC27M9

## LinCMOS™ PRECISION QUAD OPERATIONAL AMPLIFIERS

SLOS093C – OCTOBER 1987 – REVISED MAY 1999

### operating characteristics, $V_{DD} = 5\text{ V}$ , $T_A = 25^\circ\text{C}$

PARAMETER		TEST CONDITIONS		TLC27M4Y			UNIT
				MIN	TYP	MAX	
SR	Slew rate at unity gain	$R_L = 100\text{ k}\Omega$ , $C_L = 20\text{ pF}$ , See Figure 1	$V_{IPP} = 1\text{ V}$	0.43		$\text{V}/\mu\text{s}$	
			$V_{IPP} = 2.5\text{ V}$	0.40			
$V_n$	Equivalent input noise voltage	$f = 1\text{ kHz}$ , See Figure 2	$R_S = 20\ \Omega$ ,	32		$\text{nV}/\sqrt{\text{Hz}}$	
B <sub>OM</sub>	Maximum output-swing bandwidth	$V_O = V_{OH}$ , $R_L = 100\text{ k}\Omega$ ,	$C_L = 20\text{ pF}$ , See Figure 1	55		kHz	
B <sub>1</sub>	Unity-gain bandwidth	$V_I = 10\text{ mV}$ , See Figure 3	$C_L = 20\text{ pF}$ ,	525		kHz	
$\phi_m$	Phase margin	$V_I = 10\text{ mV}$ , $C_L = 20\text{ pF}$ ,	$f = B_1$ , See Figure 3	40°			

### operating characteristics, $V_{DD} = 10\text{ V}$ , $T_A = 25^\circ\text{C}$

PARAMETER		TEST CONDITIONS		TLC27M4Y			UNIT
				MIN	TYP	MAX	
SR	Slew rate at unity gain	$R_L = 100\text{ k}\Omega$ , $C_L = 20\text{ pF}$ , See Figure 1	$V_{IPP} = 1\text{ V}$	0.62		$\text{V}/\mu\text{s}$	
			$V_{IPP} = 5.5\text{ V}$	0.56			
$V_n$	Equivalent input noise voltage	$f = 1\text{ kHz}$ , See Figure 2	$R_S = 20\ \Omega$ ,	32		$\text{nV}/\sqrt{\text{Hz}}$	
B <sub>OM</sub>	Maximum output-swing bandwidth	$V_O = V_{OH}$ , $R_L = 100\text{ k}\Omega$ ,	$C_L = 20\text{ pF}$ , See Figure 1	35		kHz	
B <sub>1</sub>	Unity-gain bandwidth	$V_I = 10\text{ mV}$ , See Figure 3	$C_L = 20\text{ pF}$ ,	635		kHz	
$\phi_m$	Phase margin	$V_I = 10\text{ mV}$ , $C_L = 20\text{ pF}$ ,	$f = B_1$ , See Figure 3	43°			





PARAMETER MEASUREMENT INFORMATION

single-supply versus split-supply test circuits

Because the TLC27M4 and TLC27M9 are optimized for single-supply operation, circuit configurations used for the various tests often present some inconvenience since the input signal, in many cases, must be offset from ground. This inconvenience can be avoided by testing the device with split supplies and the output load tied to the negative rail. A comparison of single-supply versus split-supply test circuits is shown below. The use of either circuit gives the same result.

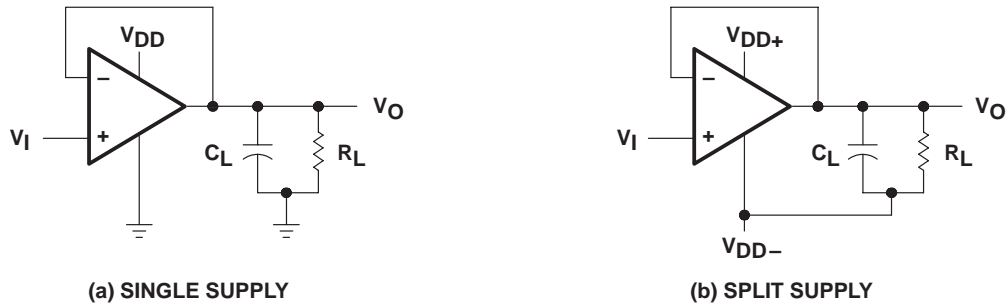

Figure 1. Unity-Gain Amplifier

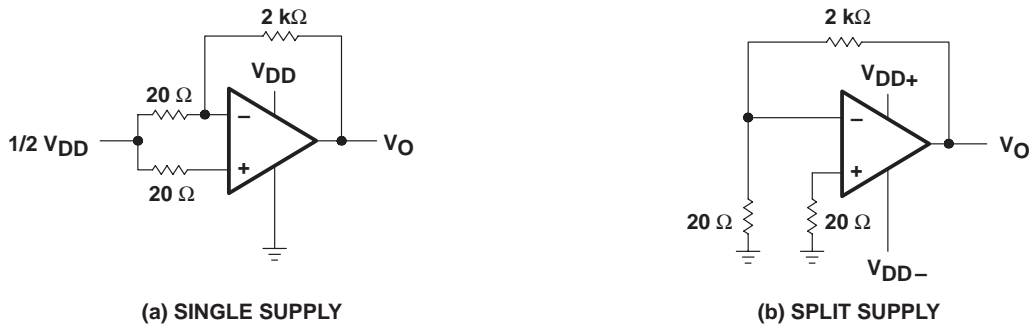

Figure 2. Noise-Test Circuit

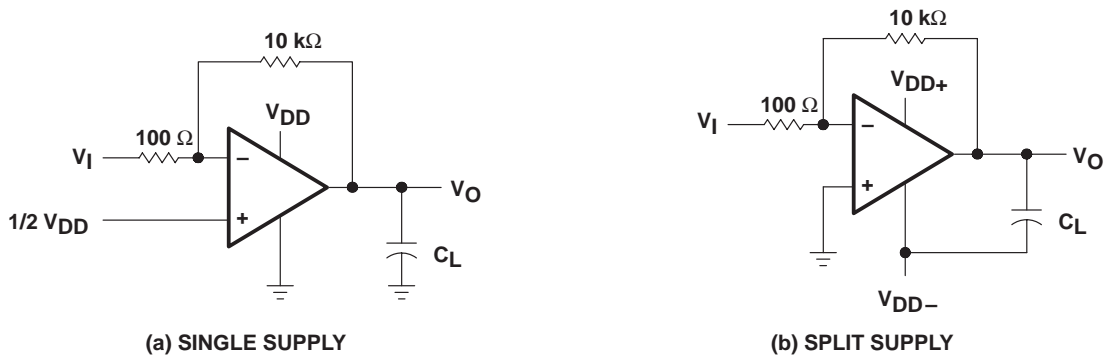

Figure 3. Gain-of-100 Inverting Amplifier

## PARAMETER MEASUREMENT INFORMATION

### input bias current

Because of the high input impedance of the TLC27M4 and TLC27M9 operational amplifiers, attempts to measure the input bias current can result in erroneous readings. The bias current at normal room ambient temperature is typically less than 1 pA, a value that is easily exceeded by leakages on the test socket. Two suggestions are offered to avoid erroneous measurements:

1. Isolate the device from other potential leakage sources. Use a grounded shield around and between the device inputs (see Figure 4). Leakages that would otherwise flow to the inputs are shunted away.
2. Compensate for the leakage of the test socket by actually performing an input bias current test (using a picoammeter) with no device in the test socket. The actual input bias current can then be calculated by subtracting the open-socket leakage readings from the readings obtained with a device in the test socket.

One word of caution—many automatic testers as well as some bench-top operational amplifier testers use the servo-loop technique with a resistor in series with the device input to measure the input bias current; the voltage drop across the series resistor is measured and the bias current is calculated. This method requires that a device be inserted into the test socket to obtain a correct reading; therefore, an open-socket reading is not feasible using this method.

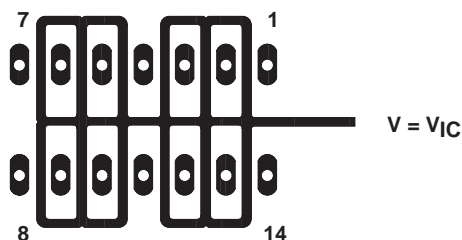

Figure 4. Isolation Metal Around Device Inputs  
(J and N packages)

### low-level output voltage

To obtain low-supply-voltage operation, some compromise was necessary in the input stage. This compromise results in the device low-level output being dependent on both the common-mode input voltage level as well as the differential input voltage level. When attempting to correlate low-level output readings with those quoted in the electrical specifications, these two conditions should be observed. If conditions other than these are to be used, please refer to Figures 14 through 19 in the *Typical Characteristics* of this data sheet.

## PARAMETER MEASUREMENT INFORMATION

### input offset voltage temperature coefficient

Erroneous readings often result from attempts to measure temperature coefficient of input offset voltage. This parameter is actually a calculation using input offset voltage measurements obtained at two different temperatures. When one (or both) of the temperatures is below freezing, moisture can collect on both the device and the test socket. This moisture results in leakage and contact resistance, which can cause erroneous input offset voltage readings. The isolation techniques previously mentioned have no effect on the leakage since the moisture also covers the isolation metal itself, thereby rendering it useless. It is suggested that these measurements be performed at temperatures above freezing to minimize error.

### full-power response

Full-power response, the frequency above which the operational amplifier slew rate limits the output voltage swing, is often specified two ways: full-linear response and full-peak response. The full-linear response is generally measured by monitoring the distortion level of the output, while increasing the frequency of a sinusoidal input signal until the maximum frequency is found above which the output contains significant distortion. The full-peak response is defined as the maximum output frequency, without regard to distortion, above which full peak-to-peak output swing cannot be maintained.

Because there is no industry-wide accepted value for significant distortion, the full-peak response is specified in this data sheet and is measured using the circuit of Figure 1. The initial setup involves the use of a sinusoidal input to determine the maximum peak-to-peak output of the device (the amplitude of the sinusoidal wave is increased until clipping occurs). The sinusoidal wave is then replaced with a square wave of the same amplitude. The frequency is then increased until the maximum peak-to-peak output can no longer be maintained (Figure 5). A square wave is used to allow a more accurate determination of the point at which the maximum peak-to-peak output is reached.

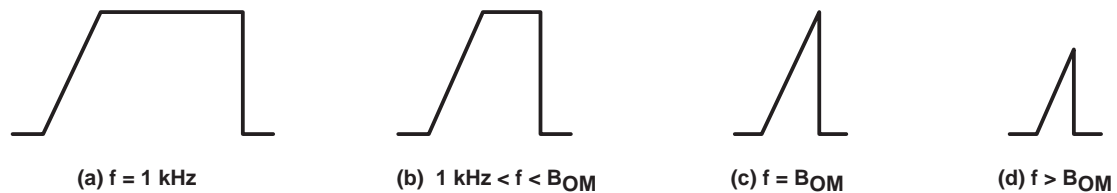

Figure 5. Full-Power-Response Output Signal

### test time

Inadequate test time is a frequent problem, especially when testing CMOS devices in a high-volume, short-test-time environment. Internal capacitances are inherently higher in CMOS than in bipolar and BiFET devices and require longer test times than their bipolar and BiFET counterparts. The problem becomes more pronounced with reduced supply levels and lower temperatures.

**TLC27M4, TLC27M4A, TLC27M4B, TLC27M4Y, TLC27M9**  
**LinCMOS™ PRECISION QUAD OPERATIONAL AMPLIFIERS**

SLOS093C – OCTOBER 1987 – REVISED MAY 1999

**TYPICAL CHARACTERISTICS**

**Table of Graphs**

		<b>FIGURE</b>	
$V_{IO}$	Input offset voltage	Distribution	6, 7
$\alpha_{VIO}$	Temperature coefficient of input offset voltage	Distribution	8, 9
$V_{OH}$	High-level output voltage	vs High-level output current	10, 11
		vs Supply voltage	12
		vs Free-air temperature	13
$V_{OL}$	Low-level output voltage	vs Common-mode input voltage	14, 15
		vs Differential input voltage	16
		vs Free-air temperature	17
		vs Low-level output current	18, 19
$A_{VD}$	Differential voltage amplification	vs Supply voltage	20
		vs Free-air temperature	21
		vs Frequency	32, 33
$I_{IB}$	Input bias current	vs Free-air temperature	22
$I_{IO}$	Input offset current	vs Free-air temperature	22
$V_{IC}$	Common-mode input voltage	vs Supply voltage	23
$I_{DD}$	Supply current	vs Supply voltage	24
		vs Free-air temperature	25
SR	Slew rate	vs Supply voltage	26
		vs Free-air temperature	27
	Normalized slew rate	vs Free-air temperature	28
$V_{O(PP)}$	Maximum peak-to-peak output voltage	vs Frequency	29
$B_1$	Unity-gain bandwidth	vs Free-air temperature	30
		vs Supply voltage	31
	Phase shift	vs Frequency	32, 33
$\phi_m$	Phase margin	vs Supply voltage	34
		vs Free-air temperature	35
		vs Load capacitance	36
$V_n$	Equivalent input noise voltage	vs Frequency	37



TYPICAL CHARACTERISTICS

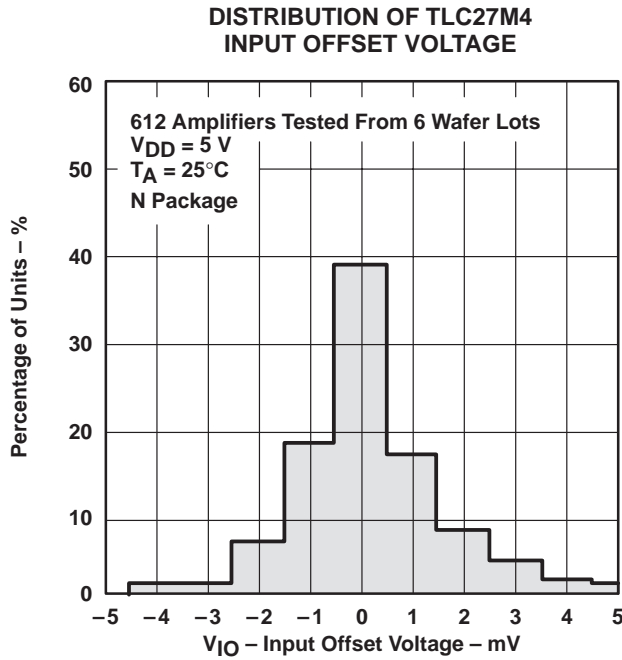

Figure 6

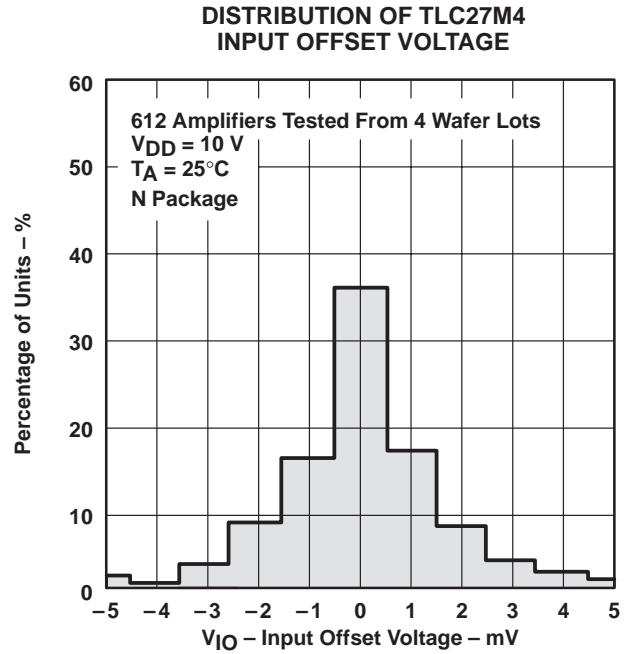

Figure 7

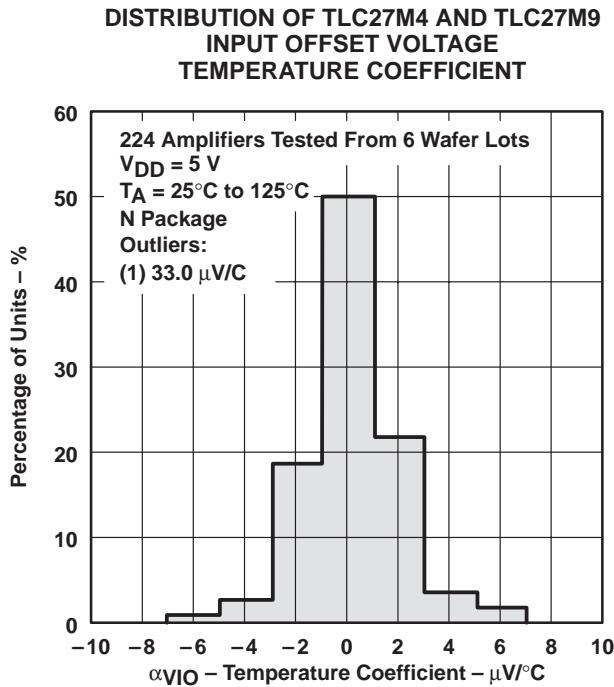

Figure 8

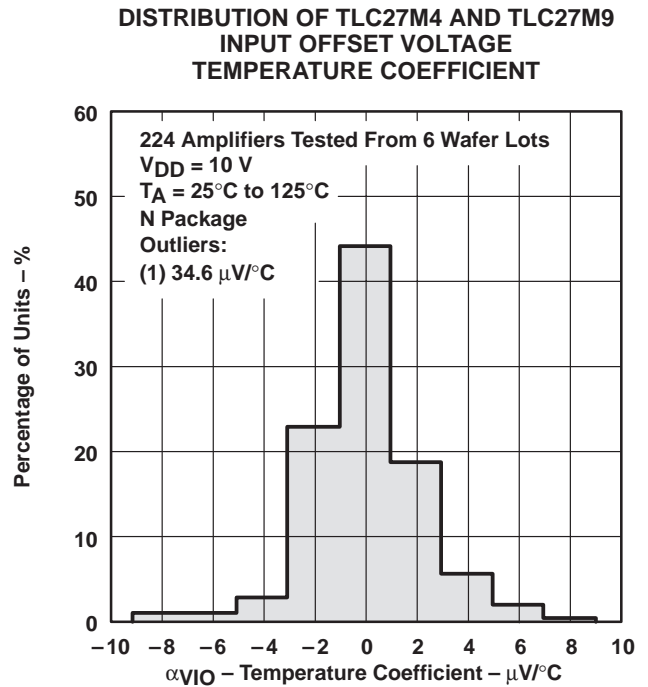

Figure 9

TYPICAL CHARACTERISTICS†

HIGH-LEVEL OUTPUT VOLTAGE  
 vs  
 HIGH-LEVEL OUTPUT CURRENT

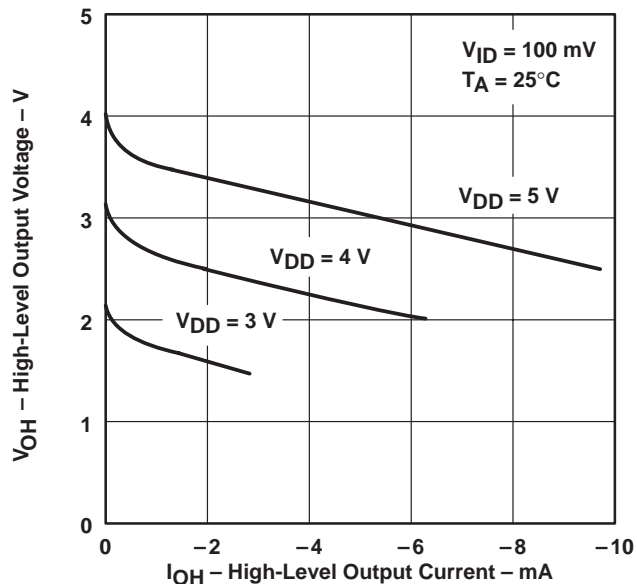

Figure 10

HIGH-LEVEL OUTPUT VOLTAGE  
 vs  
 HIGH-LEVEL OUTPUT CURRENT

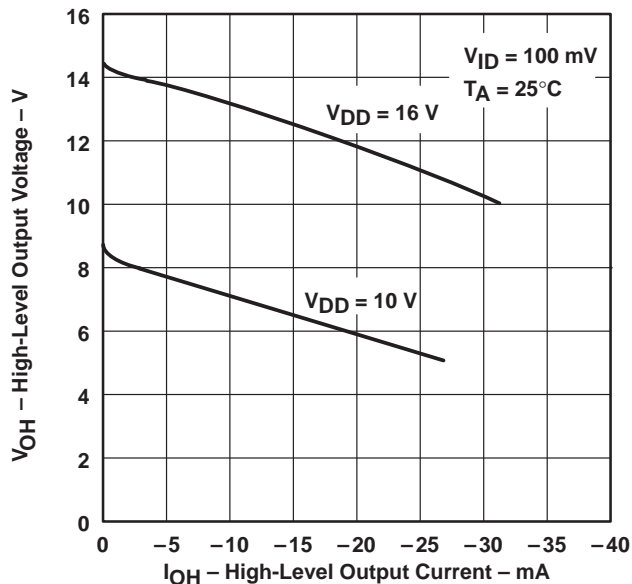

Figure 11

HIGH-LEVEL OUTPUT VOLTAGE  
 vs  
 SUPPLY VOLTAGE

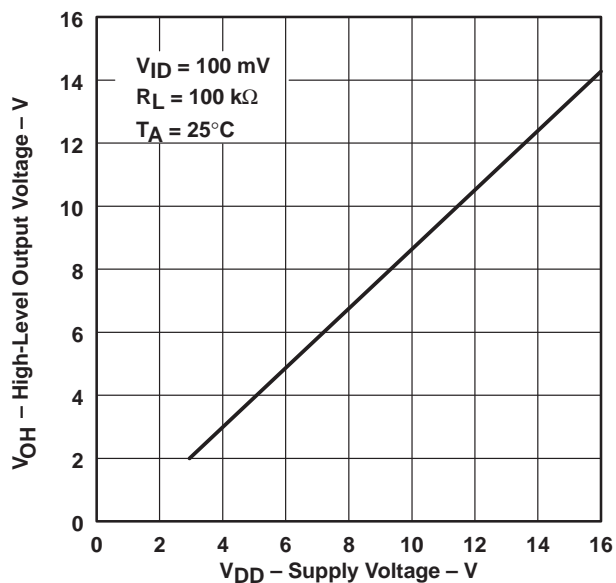

Figure 12

HIGH-LEVEL OUTPUT VOLTAGE  
 vs  
 FREE-AIR TEMPERATURE

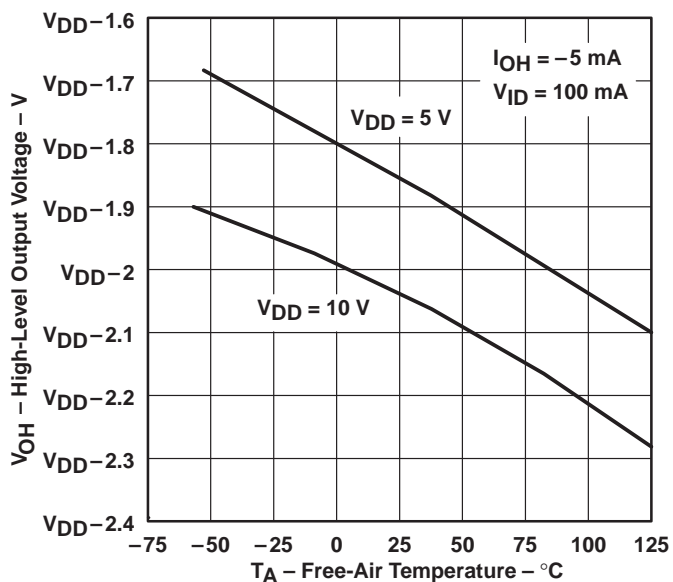

Figure 13

† Data at high and low temperatures are applicable only within the rated operating free-air temperature ranges of the various devices.

TYPICAL CHARACTERISTICS†

LOW-LEVEL OUTPUT VOLTAGE  
 vs  
 COMMON-MODE INPUT VOLTAGE

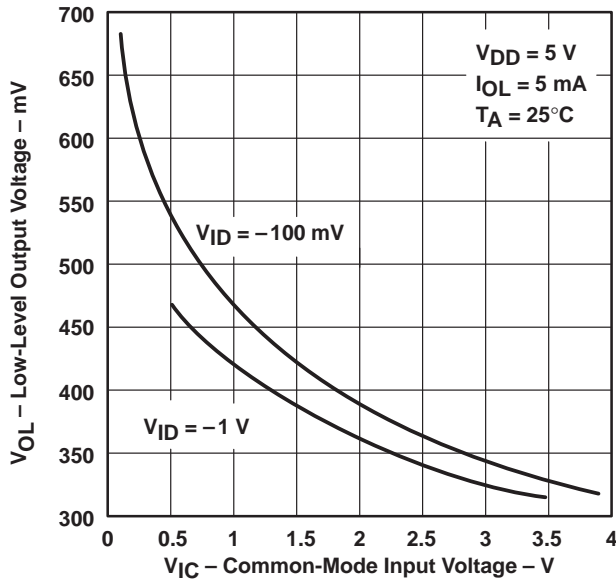

Figure 14

LOW-LEVEL OUTPUT VOLTAGE  
 vs  
 COMMON-MODE INPUT VOLTAGE

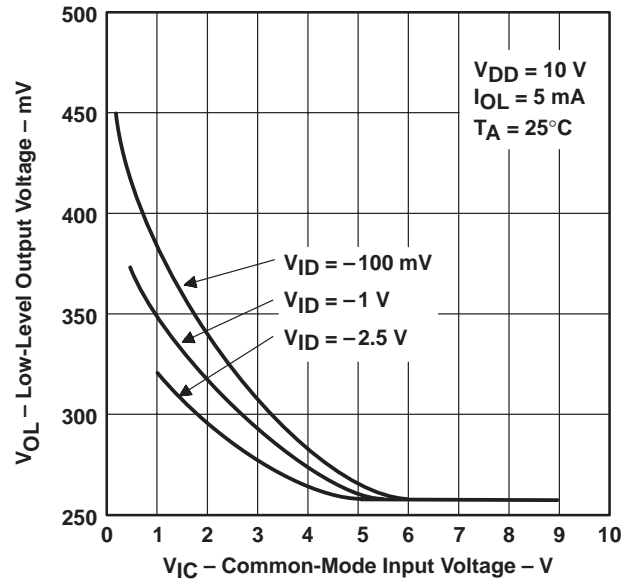

Figure 15

LOW-LEVEL OUTPUT VOLTAGE  
 vs  
 DIFFERENTIAL INPUT VOLTAGE

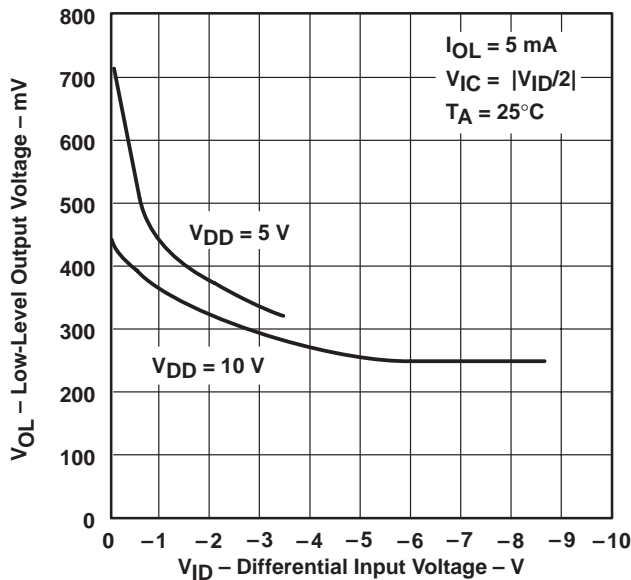

Figure 16

LOW-LEVEL OUTPUT VOLTAGE  
 vs  
 FREE-AIR TEMPERATURE

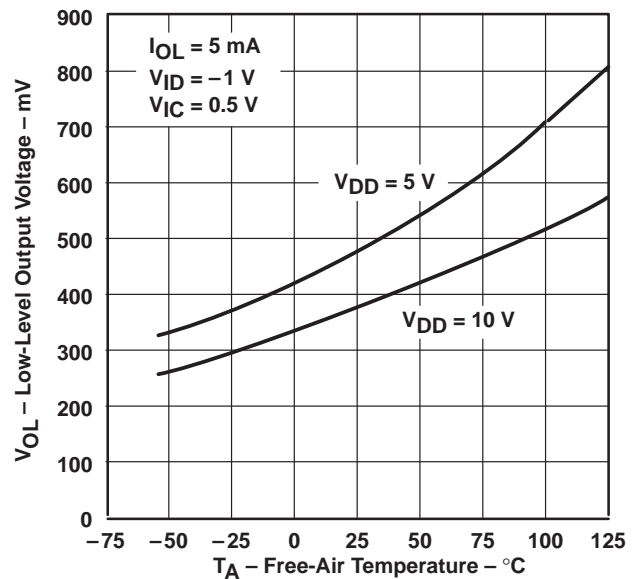

Figure 17

† Data at high and low temperatures are applicable only within the rated operating free-air temperature ranges of the various devices.

# TLC27M4, TLC27M4A, TLC27M4B, TLC27M4Y, TLC27M9 LinCMOS™ PRECISION QUAD OPERATIONAL AMPLIFIERS

SLOS093C – OCTOBER 1987 – REVISED MAY 1999

## TYPICAL CHARACTERISTICS†

LOW-LEVEL OUTPUT VOLTAGE  
vs  
LOW-LEVEL OUTPUT CURRENT

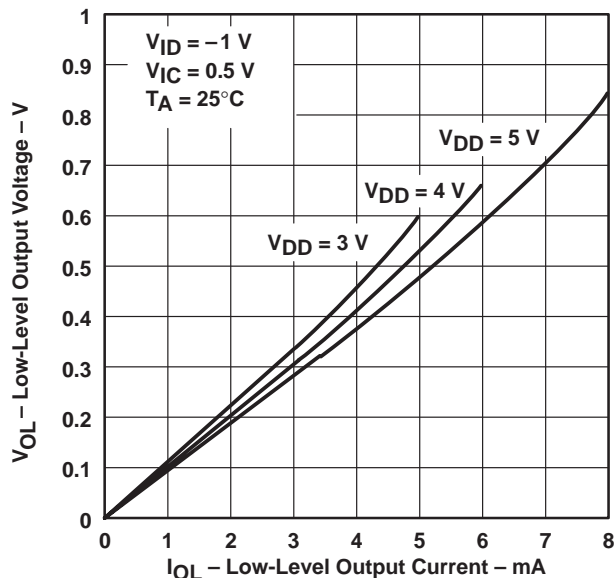

Figure 18

LOW-LEVEL OUTPUT VOLTAGE  
vs  
LOW-LEVEL OUTPUT CURRENT

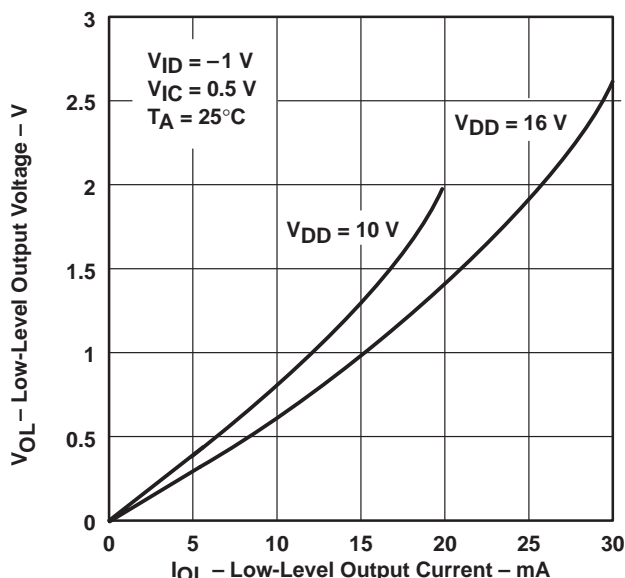

Figure 19

LARGE-SIGNAL  
DIFFERENTIAL VOLTAGE AMPLIFICATION  
vs  
SUPPLY VOLTAGE

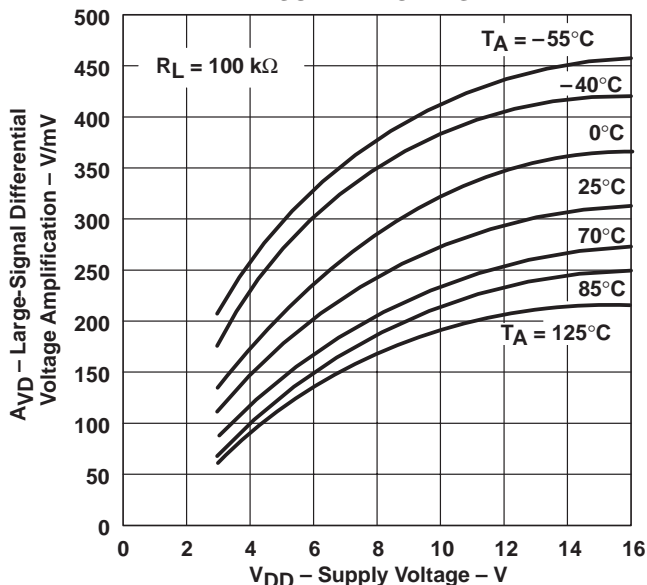

Figure 20

LARGE-SIGNAL  
DIFFERENTIAL VOLTAGE AMPLIFICATION  
vs  
FREE-AIR TEMPERATURE

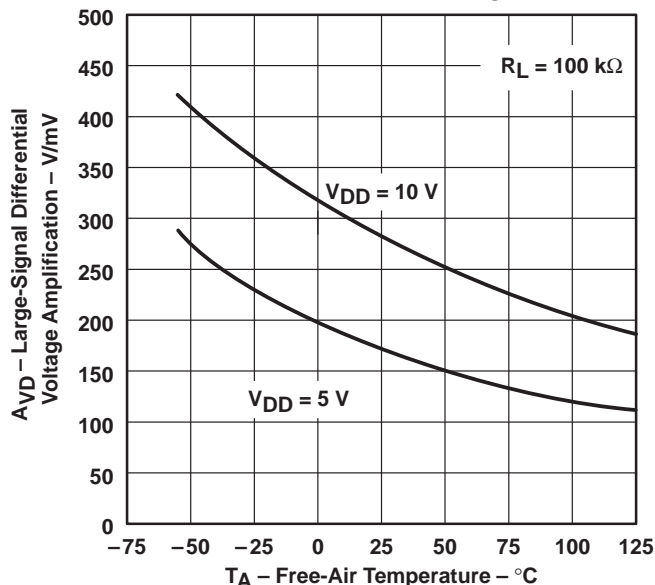

Figure 21

† Data at high and low temperatures are applicable only within the rated operating free-air temperature ranges of the various devices.





TYPICAL CHARACTERISTICS†

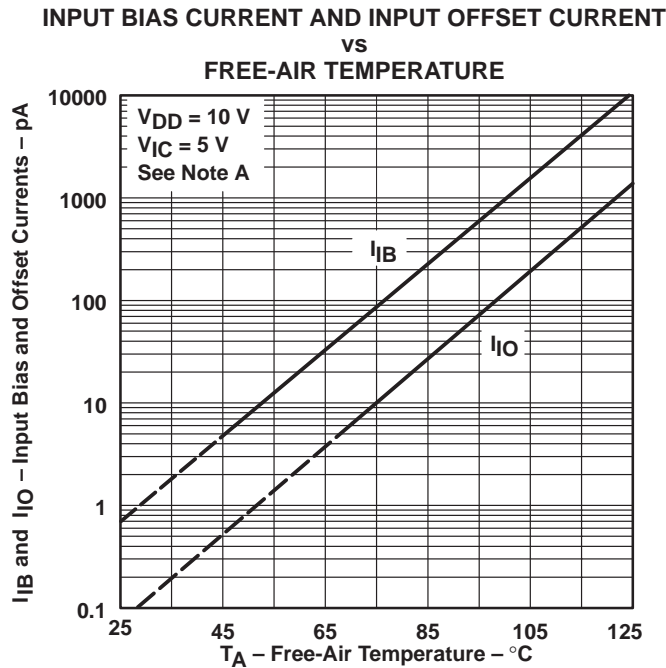

NOTE A: The typical values of input bias current and input offset current below 5 pA were determined mathematically.

Figure 22

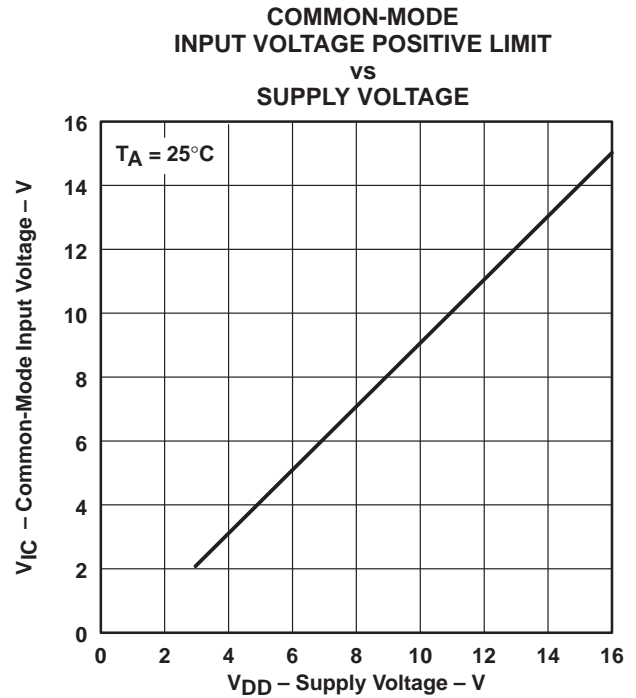

Figure 23

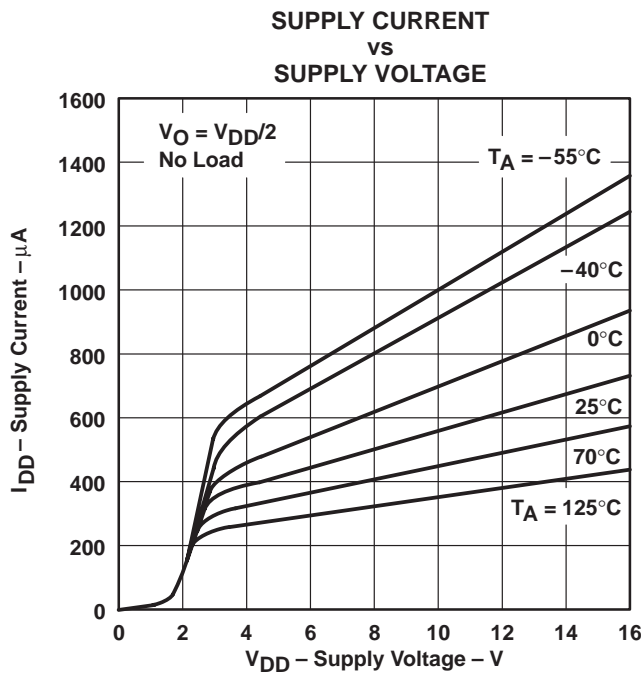

Figure 24

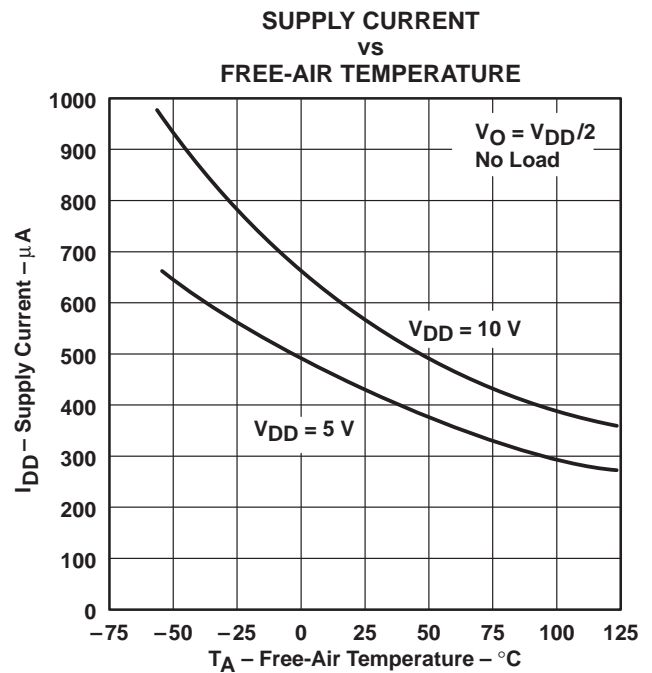

Figure 25

† Data at high and low temperatures are applicable only within the rated operating free-air temperature ranges of the various devices.

# TLC27M4, TLC27M4A, TLC27M4B, TLC27M4Y, TLC27M9 LinCMOS™ PRECISION QUAD OPERATIONAL AMPLIFIERS

SLOS093C – OCTOBER 1987 – REVISED MAY 1999

## TYPICAL CHARACTERISTICS†

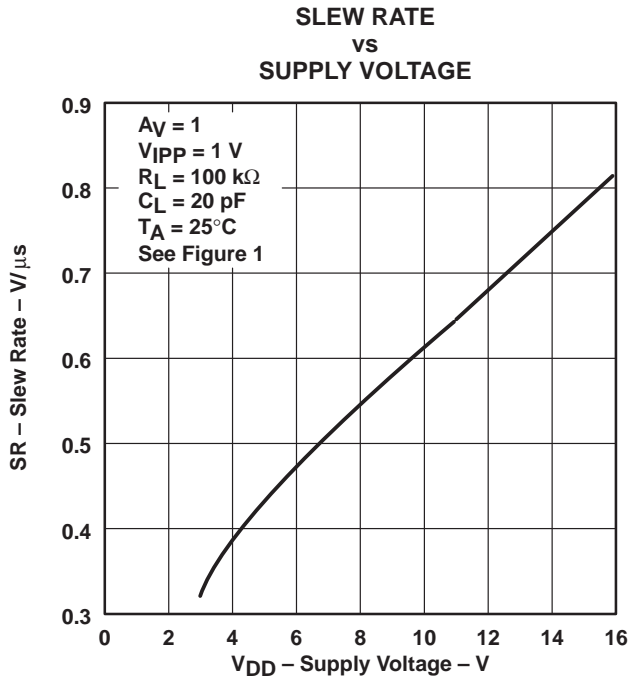

Figure 26

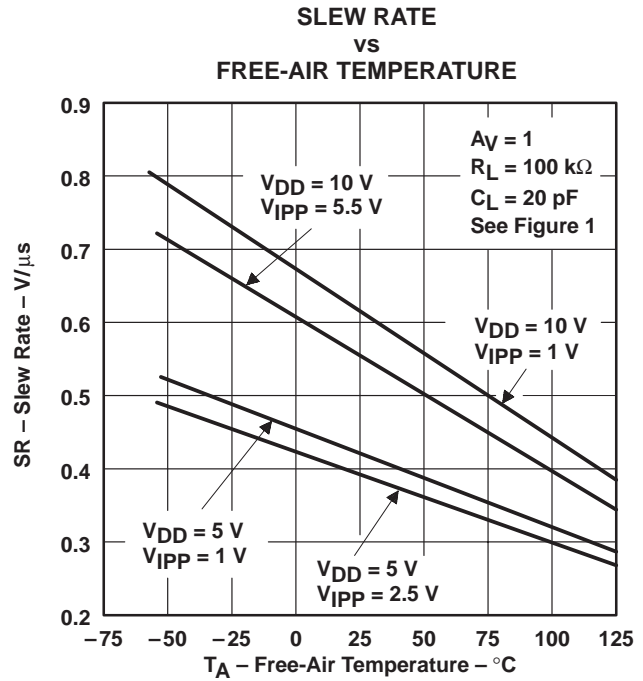

Figure 27

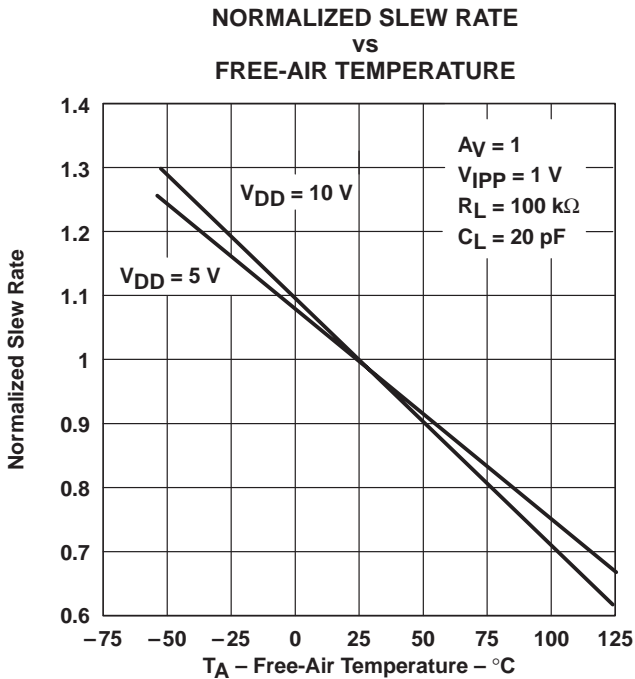

Figure 28

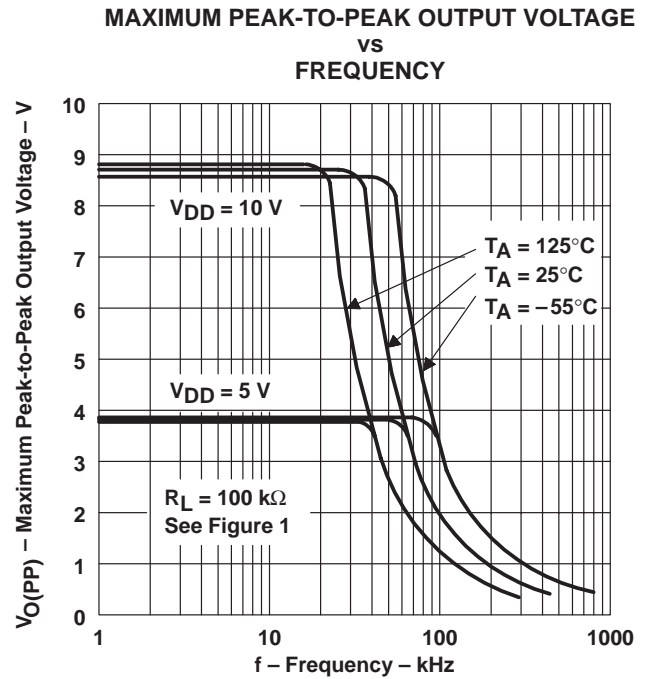

Figure 29

† Data at high and low temperatures are applicable only within the rated operating free-air temperature ranges of the various devices.

TYPICAL CHARACTERISTICS†

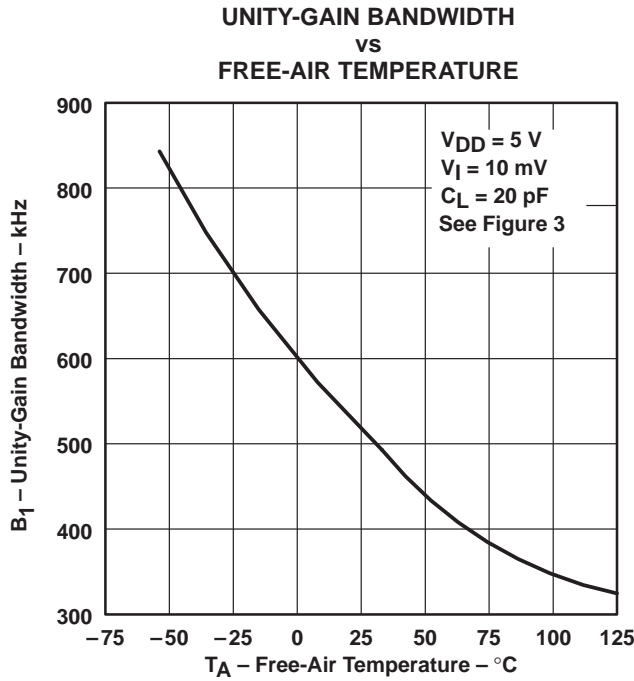

Figure 30

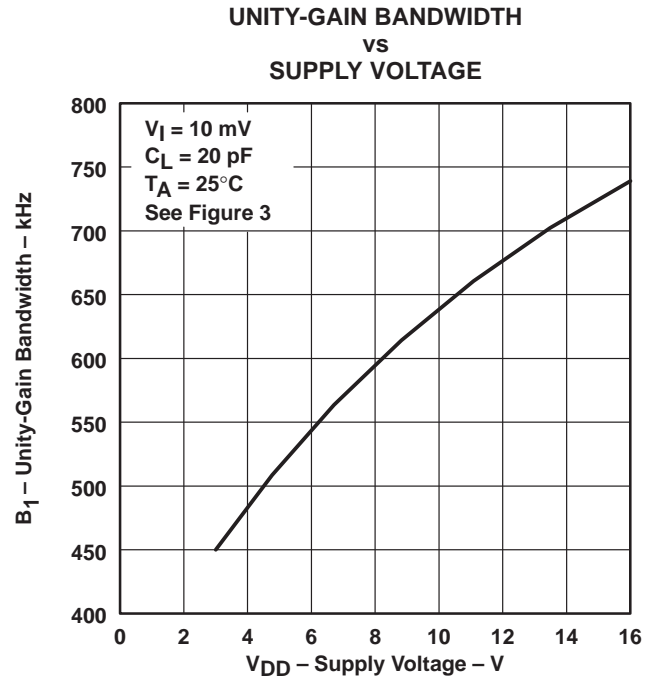

Figure 31

**LARGE-SIGNAL DIFFERENTIAL VOLTAGE  
 AMPLIFICATION AND PHASE SHIFT  
 vs  
 FREQUENCY**

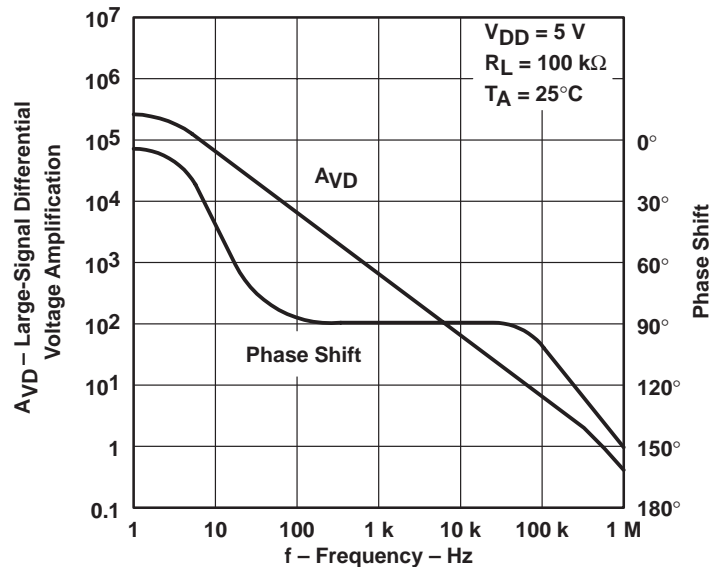

Figure 32

† Data at high and low temperatures are applicable only within the rated operating free-air temperature ranges of the various devices.

TYPICAL CHARACTERISTICS†

LARGE-SIGNAL DIFFERENTIAL VOLTAGE  
 AMPLIFICATION AND PHASE SHIFT  
 VS  
 FREQUENCY

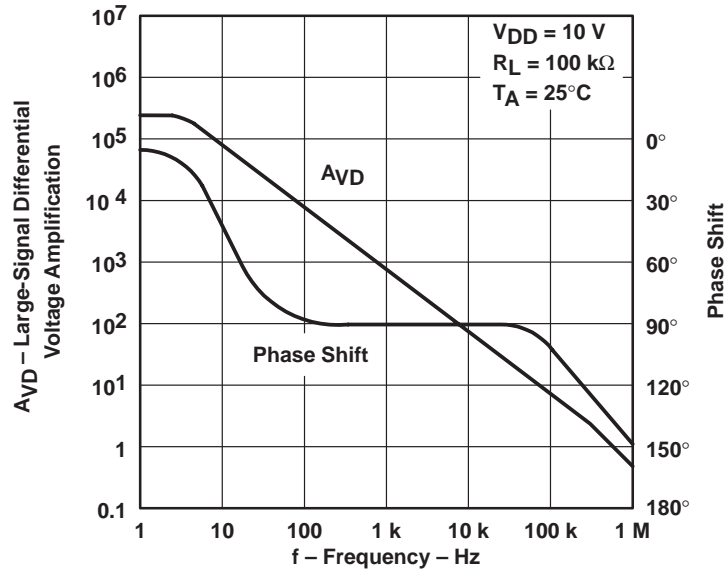

Figure 33

PHASE MARGIN  
 VS  
 SUPPLY VOLTAGE

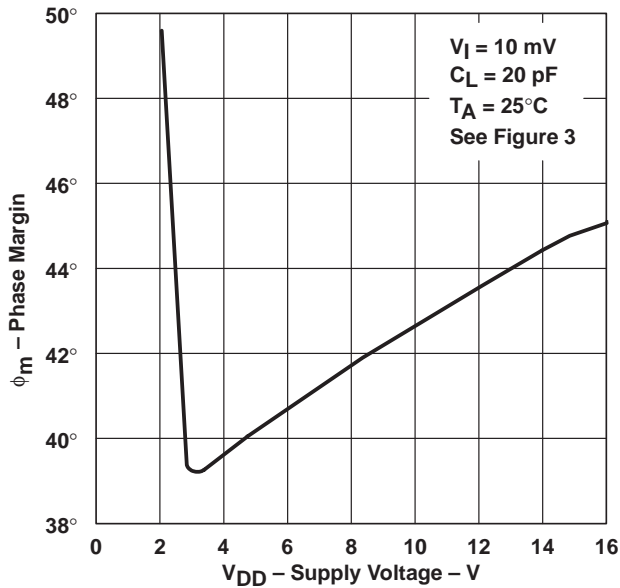

Figure 34

PHASE MARGIN  
 VS  
 FREE-AIR TEMPERATURE

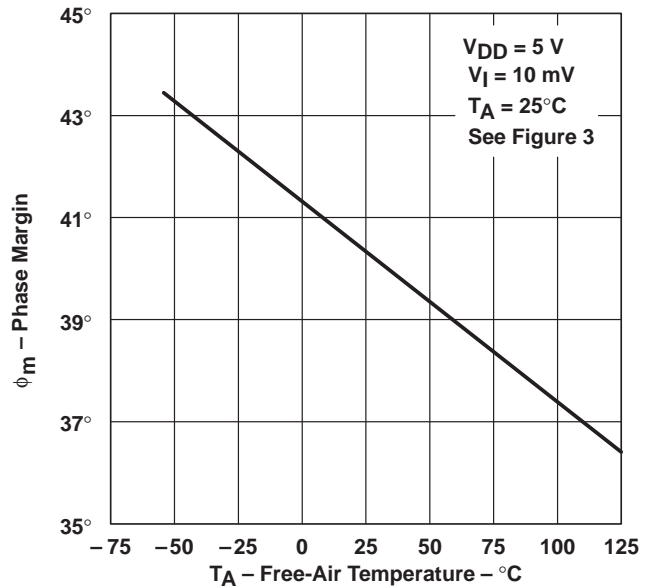

Figure 35

† Data at high and low temperatures are applicable only within the rated operating free-air temperature ranges of the various devices.

TYPICAL CHARACTERISTICS

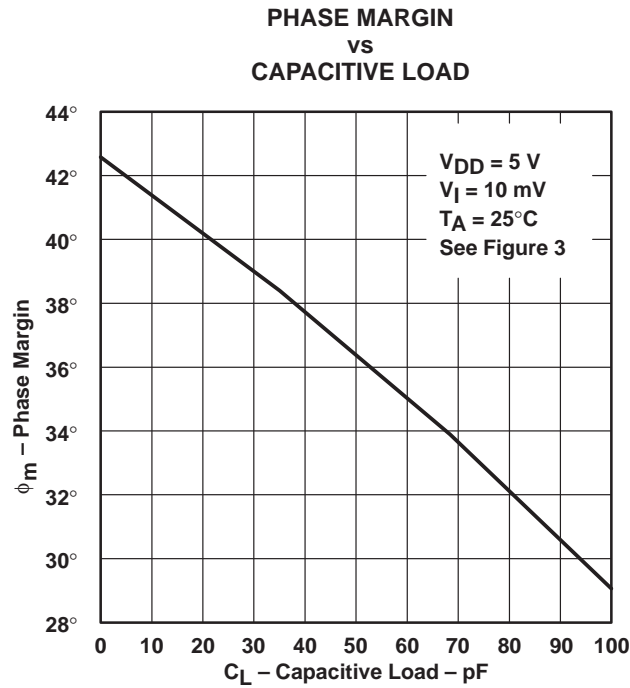

Figure 36

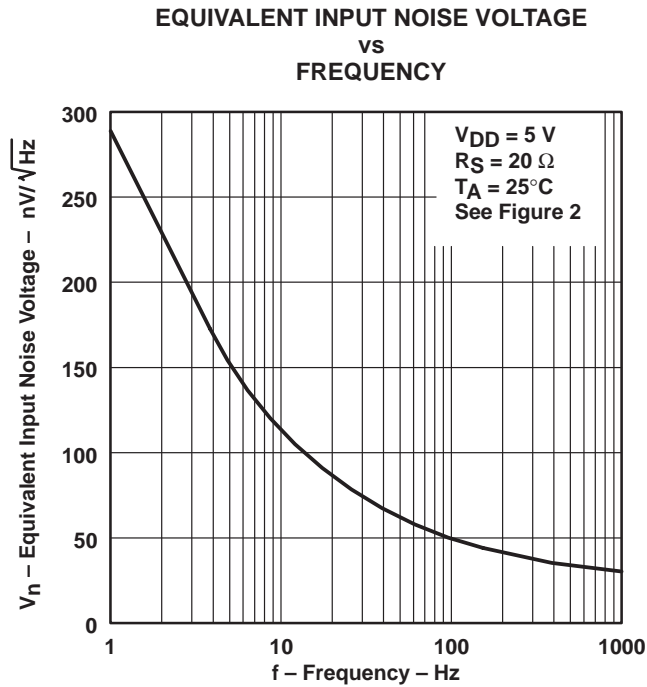

Figure 37

APPLICATION INFORMATION

single-supply operation

While the TLC27M4 and TLC27M9 perform well using dual power supplies (also called balanced or split supplies), the design is optimized for single-supply operation. This design includes an input common-mode voltage range that encompasses ground as well as an output voltage range that pulls down to ground. The supply voltage range extends down to 3 V (C-suffix types), thus allowing operation with supply levels commonly available for TTL and HCMOS; however, for maximum dynamic range, 16-V single-supply operation is recommended.

Many single-supply applications require that a voltage be applied to one input to establish a reference level that is above ground. A resistive voltage divider is usually sufficient to establish this reference level (see Figure 38). The low input bias current of the TLC27M4 and TLC27M9 permits the use of very large resistive values to implement the voltage divider, thus minimizing power consumption.

The TLC27M4 and TLC27M9 work well in conjunction with digital logic; however, when powering both linear devices and digital logic from the same power supply, the following precautions are recommended:

1. Power the linear devices from separate bypassed supply lines (see Figure 39); otherwise, the linear device supply rails can fluctuate due to voltage drops caused by high switching currents in the digital logic.
2. Use proper bypass techniques to reduce the probability of noise-induced errors. Single capacitive decoupling is often adequate; however, high-frequency applications may require RC decoupling.

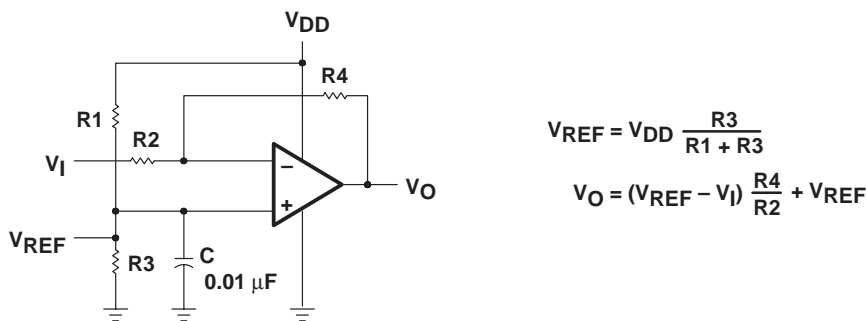

Figure 38. Inverting Amplifier With Voltage Reference

APPLICATION INFORMATION

single-supply operation (continued)

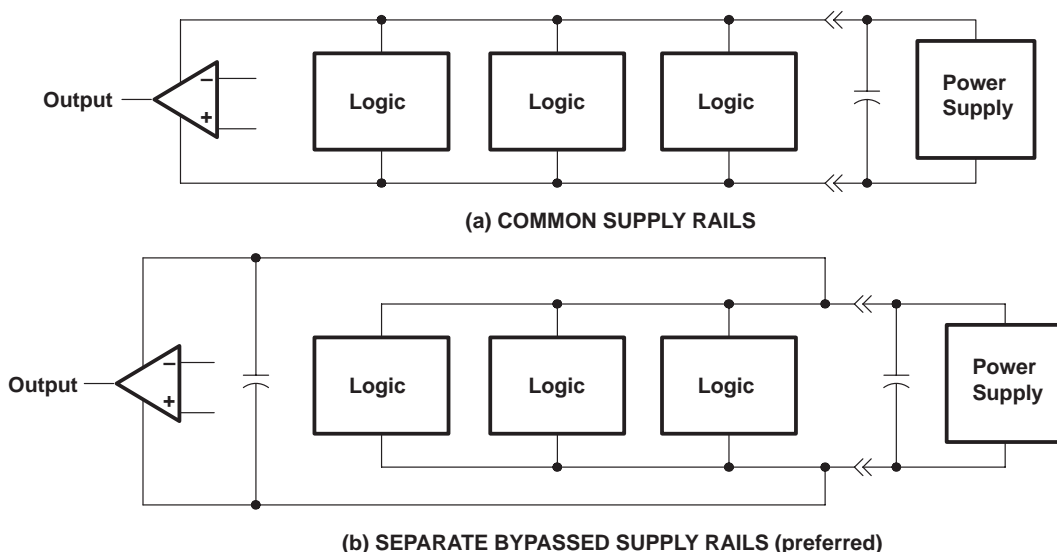

Figure 39. Common Versus Separate Supply Rails

input characteristics

The TLC27M4 and TLC27M9 are specified with a minimum and a maximum input voltage that, if exceeded at either input, could cause the device to malfunction. Exceeding this specified range is a common problem, especially in single-supply operation. Note that the lower range limit includes the negative rail, while the upper range limit is specified at  $V_{DD} - 1\text{ V}$  at  $T_A = 25^\circ\text{C}$  and at  $V_{DD} - 1.5\text{ V}$  at all other temperatures.

The use of the polysilicon-gate process and the careful input circuit design gives the TLC27M4 and TLC27M9 very good input offset voltage drift characteristics relative to conventional metal-gate processes. Offset voltage drift in CMOS devices is highly influenced by threshold voltage shifts caused by polarization of the phosphorus dopant implanted in the oxide. Placing the phosphorus dopant in a conductor (such as a polysilicon gate) alleviates the polarization problem, thus reducing threshold voltage shifts by more than an order of magnitude. The offset voltage drift with time has been calculated to be typically  $0.1\ \mu\text{V}/\text{month}$ , including the first month of operation.

Because of the extremely high input impedance and resulting low bias current requirements, the TLC27M4 and TLC27M9 are well suited for low-level signal processing; however, leakage currents on printed-circuit boards and sockets can easily exceed bias current requirements and cause a degradation in device performance. It is good practice to include guard rings around inputs (similar to those of Figure 4 in the *Parameter Measurement Information* section). These guards should be driven from a low-impedance source at the same voltage level as the common-mode input (see Figure 40).

Unused amplifiers should be connected as unity-gain followers to avoid possible oscillation.

noise performance

The noise specifications in operational amplifier circuits are greatly dependent on the current in the first-stage differential amplifier. The low input bias current requirements of the TLC27M4 and TLC27M9 result in a very low noise current, which is insignificant in most applications. This feature makes the devices especially favorable over bipolar devices when using values of circuit impedance greater than  $50\ \text{k}\Omega$ , since bipolar devices exhibit greater noise currents.

APPLICATION INFORMATION

noise performance (continued)

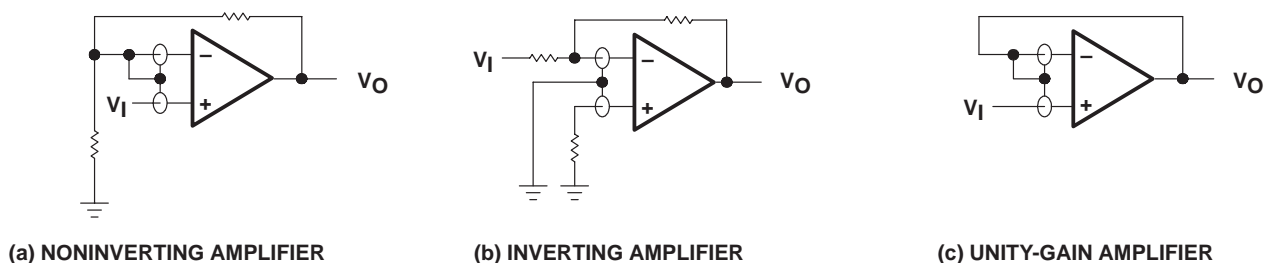

Figure 40. Guard-Ring Schemes

output characteristics

The output stage of the TLC27M4 and TLC27M9 is designed to sink and source relatively high amounts of current (see *typical characteristics*). If the output is subjected to a short-circuit condition, this high current capability can cause device damage under certain conditions. Output current capability increases with supply voltage.

All operating characteristics of the TLC27M4 and TLC27M9 were measured using a 20-pF load. The devices drive higher capacitive loads; however, as output load capacitance increases, the resulting response pole occurs at lower frequencies, thereby causing ringing, peaking, or even oscillation (see Figure 41). In many cases, adding a small amount of resistance in series with the load capacitance alleviates the problem.

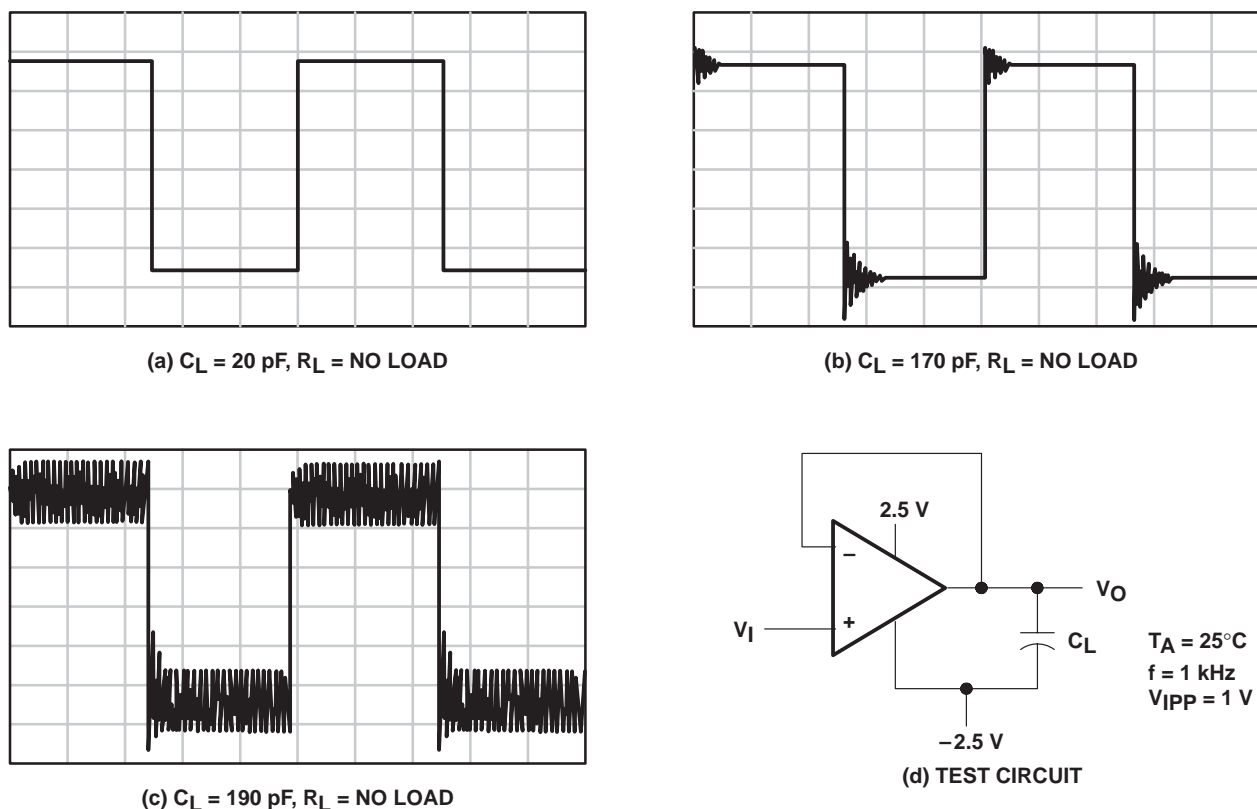

Figure 41. Effect of Capacitive Loads and Test Circuit



APPLICATION INFORMATION

output characteristics (continued)

Although the TLC27M4 and TLC27M9 possess excellent high-level output voltage and current capability, methods for boosting this capability are available, if needed. The simplest method involves the use of a pullup resistor ( $R_P$ ) connected from the output to the positive supply rail (see Figure 42). There are two disadvantages to the use of this circuit. First, the NMOS pulldown transistor N4 (see equivalent schematic) must sink a comparatively large amount of current. In this circuit, N4 behaves like a linear resistor with an on-resistance between approximately 60  $\Omega$  and 180  $\Omega$ , depending on how hard the operational amplifier input is driven. With very low values of  $R_P$ , a voltage offset from 0 V at the output occurs. Second, pullup resistor  $R_P$  acts as a drain load to N4 and the gain of the operational amplifier is reduced at output voltage levels where N5 is not supplying the output current.

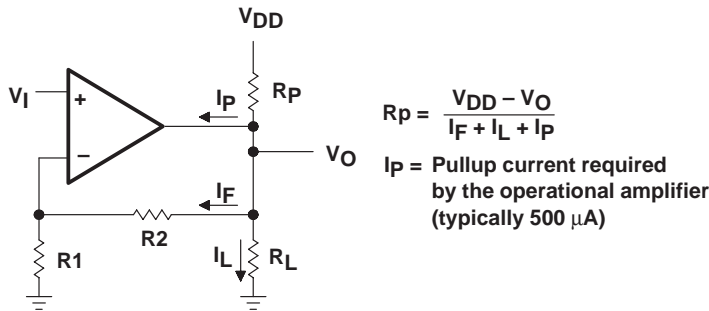

Figure 42. Resistive Pullup to Increase  $V_{OH}$

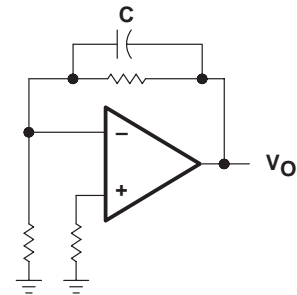

Figure 43. Compensation for Input Capacitance

feedback

Operational amplifier circuits nearly always employ feedback, and since feedback is the first prerequisite for oscillation, some caution is appropriate. Most oscillation problems result from driving capacitive loads (discussed previously) and ignoring stray input capacitance. A small-value capacitor connected in parallel with the feedback resistor is an effective remedy (see Figure 43). The value of this capacitor is optimized empirically.

electrostatic discharge protection

The TLC27M4 and TLC27M9 incorporate an internal electrostatic discharge (ESD) protection circuit that prevents functional failures at voltages up to 2000 V as tested under MIL-STD-883C, Method 3015.2. Care should be exercised, however, when handling these devices, as exposure to ESD may result in the degradation of the device parametric performance. The protection circuit also causes the input bias currents to be temperature-dependent and have the characteristics of a reverse-biased diode.

latch-up

Because CMOS devices are susceptible to latch-up due to their inherent parasitic thyristors, the TLC27M4 and TLC27M9 inputs and outputs were designed to withstand –100-mA surge currents without sustaining latch-up; however, techniques should be used to reduce the chance of latch-up whenever possible. Internal protection diodes should not, by design, be forward biased. Applied input and output voltage should not exceed the supply voltage by more than 300 mV. Care should be exercised when using capacitive coupling on pulse generators. Supply transients should be shunted by the use of decoupling capacitors (0.1  $\mu$ F typical) located across the supply rails as close to the device as possible.

APPLICATION INFORMATION

latch-up (continued)

The current path established if latch-up occurs is usually between the positive supply rail and ground; it can be triggered by surges on the supply lines and/or voltages on either the output or inputs that exceed the supply voltage. Once latch-up occurs, the current flow is limited only by the impedance of the power supply and the forward resistance of the parasitic thyristor and usually results in the destruction of the device. The chance of latch-up occurring increases with increasing temperature and supply voltages.

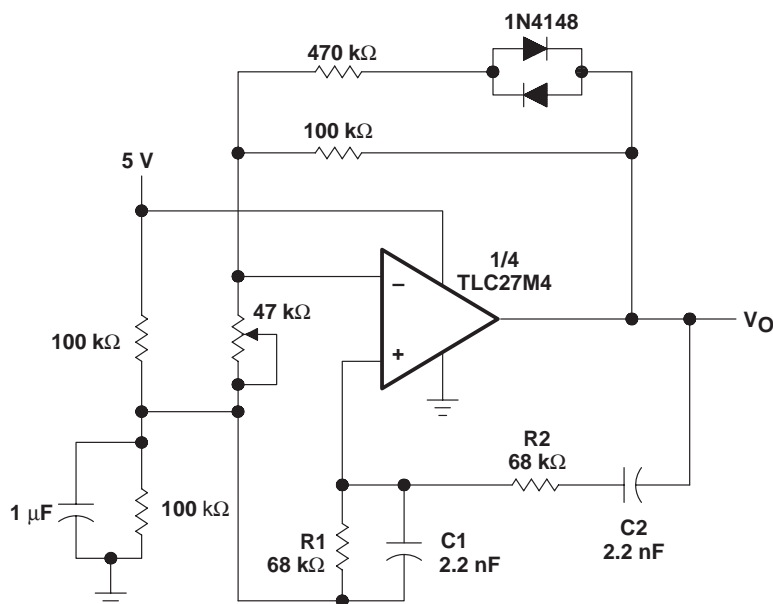

NOTE:  $V_{OPP} \approx 2\text{ V}$   

$$f_O = \frac{1}{2\pi \sqrt{R_1 R_2 C_1 C_2}}$$

Figure 44. Wien Oscillator

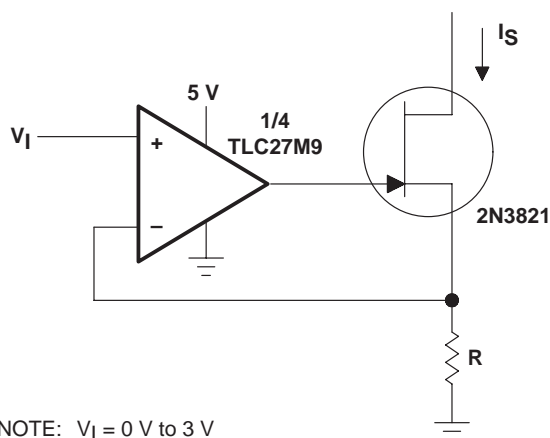

NOTE:  $V_I = 0\text{ V to } 3\text{ V}$   

$$I_S = \frac{V_I}{R}$$

Figure 45. Precision Low-Current Sink

APPLICATION INFORMATION

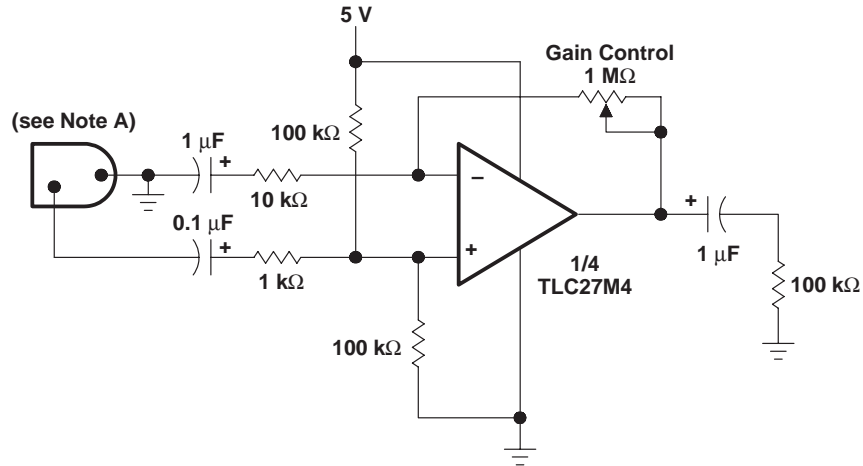

NOTE A: Low to medium impedance dynamic mike

Figure 46. Microphone Preamplifier

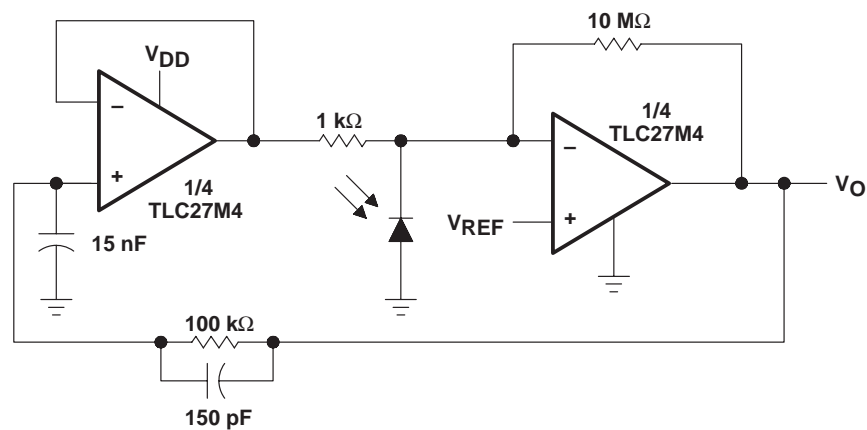

NOTE:  $V_{DD} = 4 \text{ V to } 15 \text{ V}$   
 $V_{REF} = 0 \text{ V to } V_{DD} - 2 \text{ V}$

Figure 47. Photo-Diode Amplifier With Ambient Light Rejection

APPLICATION INFORMATION

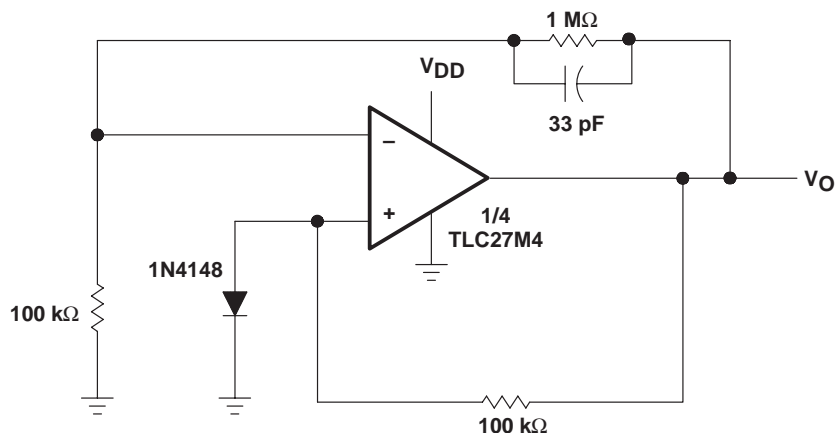

NOTE:  $V_{DD} = 8\text{ V to }16\text{ V}$   
 $V_O = 5\text{ V, }10\text{ mA}$

Figure 48. Low-Power Voltage Regulator

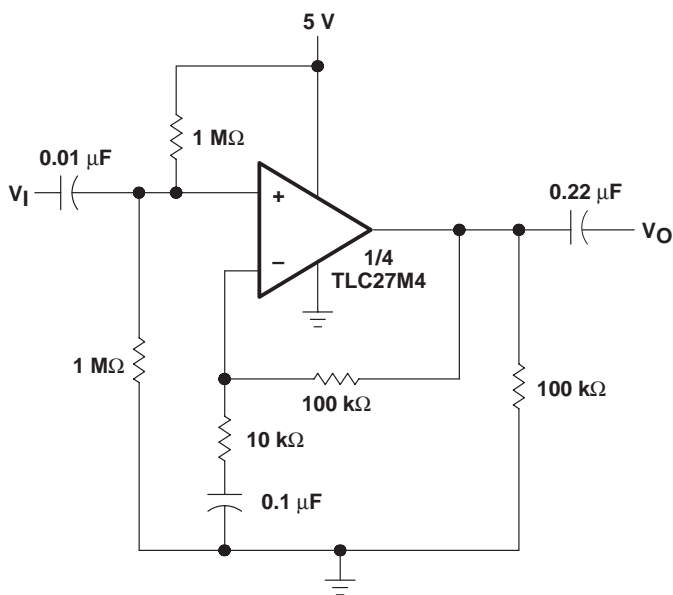

Figure 49. Single-Rail AC Amplifier

## **IMPORTANT NOTICE**

Texas Instruments and its subsidiaries (TI) reserve the right to make changes to their products or to discontinue any product or service without notice, and advise customers to obtain the latest version of relevant information to verify, before placing orders, that information being relied on is current and complete. All products are sold subject to the terms and conditions of sale supplied at the time of order acknowledgement, including those pertaining to warranty, patent infringement, and limitation of liability.

TI warrants performance of its semiconductor products to the specifications applicable at the time of sale in accordance with TI's standard warranty. Testing and other quality control techniques are utilized to the extent TI deems necessary to support this warranty. Specific testing of all parameters of each device is not necessarily performed, except those mandated by government requirements.

**CERTAIN APPLICATIONS USING SEMICONDUCTOR PRODUCTS MAY INVOLVE POTENTIAL RISKS OF DEATH, PERSONAL INJURY, OR SEVERE PROPERTY OR ENVIRONMENTAL DAMAGE ("CRITICAL APPLICATIONS"). TI SEMICONDUCTOR PRODUCTS ARE NOT DESIGNED, AUTHORIZED, OR WARRANTED TO BE SUITABLE FOR USE IN LIFE-SUPPORT DEVICES OR SYSTEMS OR OTHER CRITICAL APPLICATIONS. INCLUSION OF TI PRODUCTS IN SUCH APPLICATIONS IS UNDERSTOOD TO BE FULLY AT THE CUSTOMER'S RISK.**

In order to minimize risks associated with the customer's applications, adequate design and operating safeguards must be provided by the customer to minimize inherent or procedural hazards.

TI assumes no liability for applications assistance or customer product design. TI does not warrant or represent that any license, either express or implied, is granted under any patent right, copyright, mask work right, or other intellectual property right of TI covering or relating to any combination, machine, or process in which such semiconductor products or services might be or are used. TI's publication of information regarding any third party's products or services does not constitute TI's approval, warranty or endorsement thereof.