



1N5908 SM5908

TRANSIL™

FEATURES

- UNIDIRECTIONAL TRANSIL DIODE
- PEAK PULSE POWER : 1500 W (10/100µs)
- REVERSE STAND OFF VOLTAGE : 5 V
- LOW CLAMPING FACTOR
- FAST RESPONSE TIME
- UL RECOGNIZED

DESCRIPTION

The 1N5908 and SM5908 are dedicated to the 5 V logic circuit protection (TTL and CMOS technologies). Their low clamping voltage at high current level guarantees excellent protection for sensitive components.

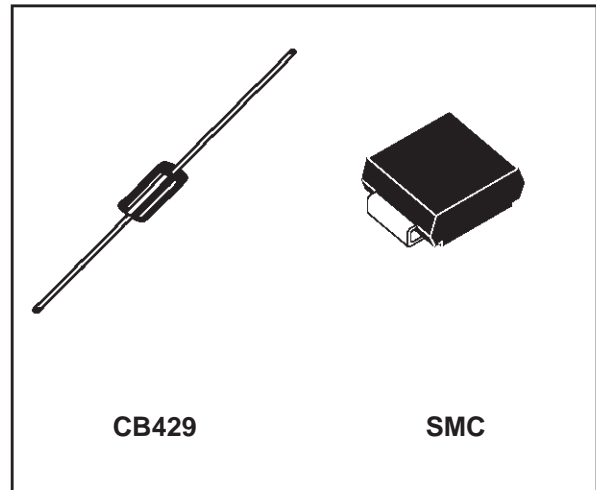

ABSOLUTE MAXIMUM RATINGS ($T_{amb} = 25^{\circ}\text{C}$).

| Symbol | Parameter | | Value | Unit |
|------------------------------------|--|--|----------------------|--|
| P _{PP} | Peak pulse power dissipation (see note1) | $T_j \text{ initial} = T_{amb}$ | 1500 | W |
| P | Power dissipation on infinite heatsink | $T_{amb} = 75^{\circ}\text{C}$ | 5 | W |
| I _{FSM} | Non repetitive surge peak forward current for unidirectional types | $t_p = 10\text{ms}$ $T_j \text{ initial} = T_{amb}$ | 200 | A |
| T _{stg} T _j | Storage temperature range Maximum junction temperature | | - 65 to + 175 175 | $^{\circ}\text{C}$ $^{\circ}\text{C}$ |
| T _L | Maximum lead temperature for soldering during 10s (at 5mm from case for CB429) | CB429 SMC | 230 260 | $^{\circ}\text{C}$ $^{\circ}\text{C}$ |

Note 1 : For a surge greater than the maximum values, the diode will fail in short-circuit.

THERMAL RESISTANCES

| Symbol | Parameter | | Value | Unit | |
|----------------------|---|---------------------------|-------|----------------------|----------------------|
| R _{th(j-l)} | Junction to leads | | 20 | $^{\circ}\text{C/W}$ | |
| R _{th(j-a)} | Junction to ambient on printed circuit. | L lead = 10 mm | CB429 | 75 | $^{\circ}\text{C/W}$ |
| | | On recommended pad layout | SMC | 75 | $^{\circ}\text{C/W}$ |

ELECTRICAL CHARACTERISTICS ($T_{amb} = 25^{\circ}\text{C}$)

| Symbol | Parameter |
|------------|---------------------------------|
| V_{RM} | Stand-off voltage |
| V_{BR} | Breakdown voltage |
| V_{CL} | Clamping voltage |
| I_{RM} | Leakage current @ V_{RM} |
| I_{PP} | Peak pulse current |
| αT | Voltage temperature coefficient |
| V_F | Forward voltage |

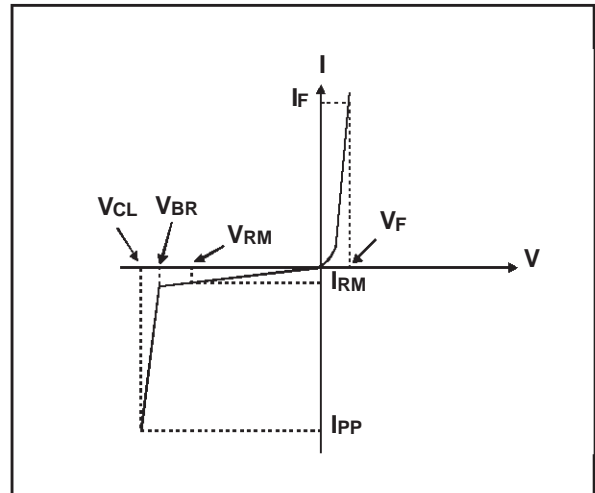

| Types | I_{RM} @ V_{RM} | | V_{BR} @ I_R | | V_{CL} @ I_{PP} | | V_{CL} @ I_{PP} | | V_{CL} @ I_{PP} | | αT | C |
|------------------|---------------------|---|------------------|-------|---------------------|-----------------------|---------------------|-----------------------|---------------------|-----------------------|----------------------------|----------|
| | max | | min | note2 | max | 10/1000 μs | max | 10/1000 μs | max | 10/1000 μs | max | note4 |
| | μA | V | V | mA | V | A | V | A | V | A | $10^{-4}/^{\circ}\text{C}$ | pF |
| 1N5908 SM5908 | 300 | 5 | 6 | 1 | 7.6 | 30 | 8 | 60 | 8.5 | 120 | 5.7 | 9500 |

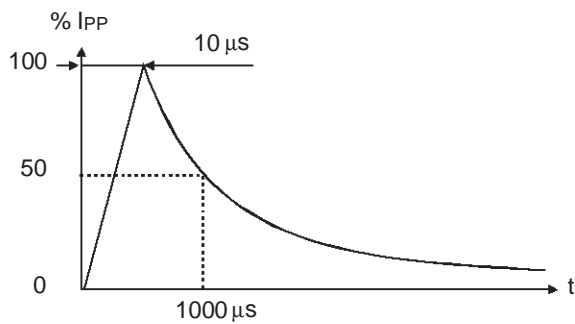

- Note 2 : Pulse test : $t_p < 50\text{ms}$
- Note 3 : $\Delta V_{BR} = \alpha T (T_{amb} - 25) V_{BR} (25^{\circ}\text{C})$.
- Note 4 : $V_R = 0\text{V}$, $F = 1\text{MHz}$

Fig. 1: Peak pulse power dissipation versus initial junction temperature (printed circuit board).

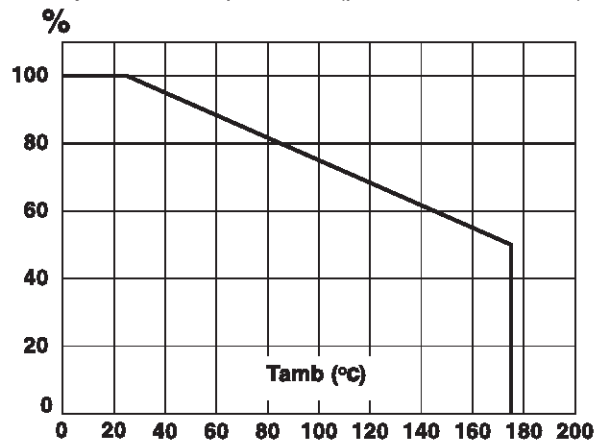

Fig. 2 : Peak pulse power versus exponential pulse duration.

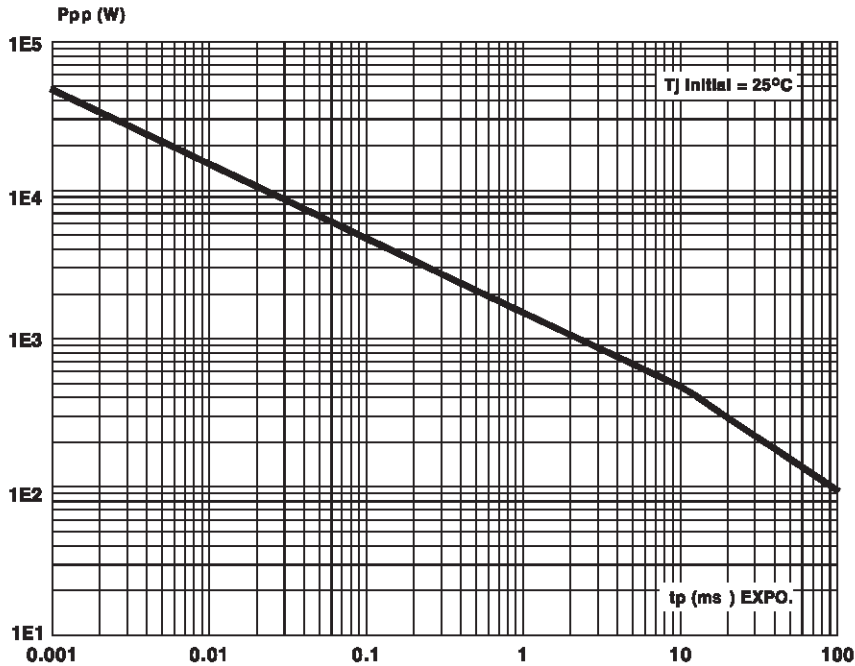
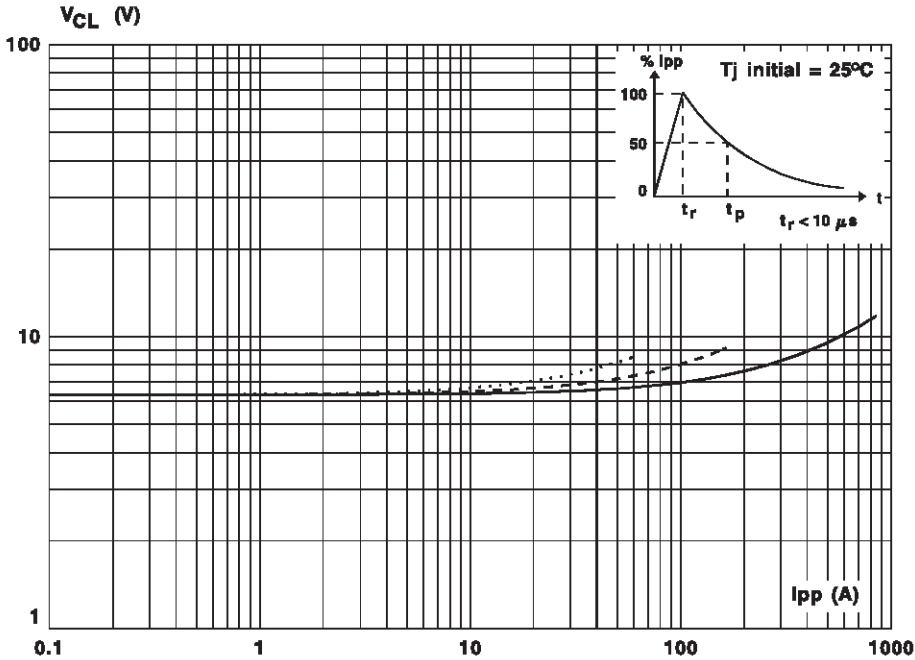

Fig. 3 : Clamping voltage versus peak pulse current.
 Exponential waveform $t_p = 10\text{ ms}$
 $t_p = 1\text{ ms}$ -----
 $t_p = 20\ \mu\text{s}$



Note : The curves of the figure 3 are specified for a junction temperature of 25 °C before surge.
 The given results may be extrapolated for other junction temperatures by using the following formula :
 $\Delta V_{BR} = \alpha T (T_{amb} - 25) * V_{BR} (25^\circ\text{C})$.

1N5908/SM5908

Fig. 4 : Capacitance versus reverse applied voltage (typical values).

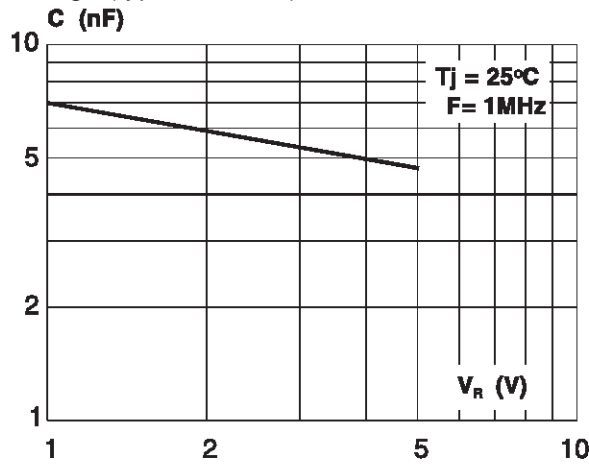

Fig. 5 : Peak forward voltage drop versus peak forward current.

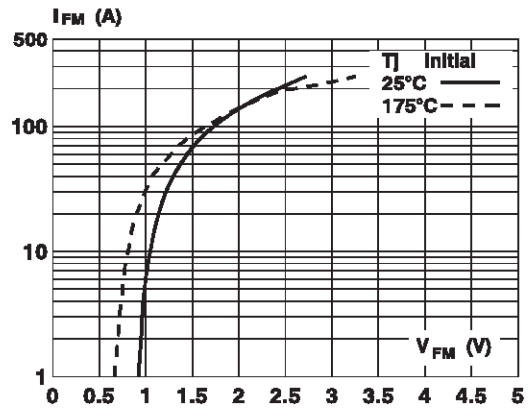

Fig. 6a/6b : Transient thermal impedance junction-ambient versus pulse duration.

Fig. 6a : CB429 Package.
(For FR4 PC Board with $L_{lead} = 10$ mm)

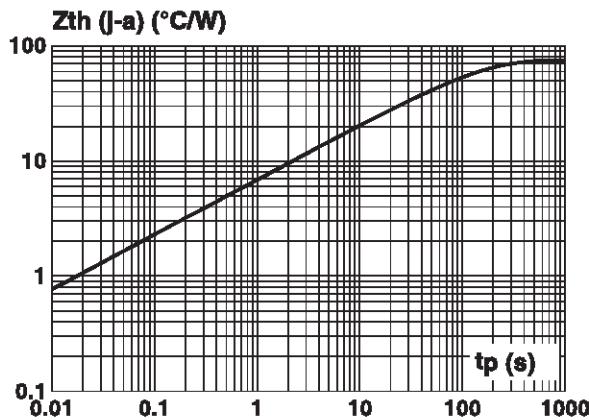

Fig. 6b : SMC Package.
Mounting on FR4 PC Board with recommended pad layout.

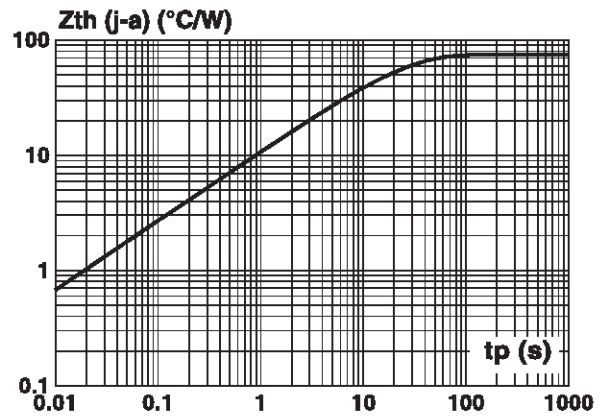
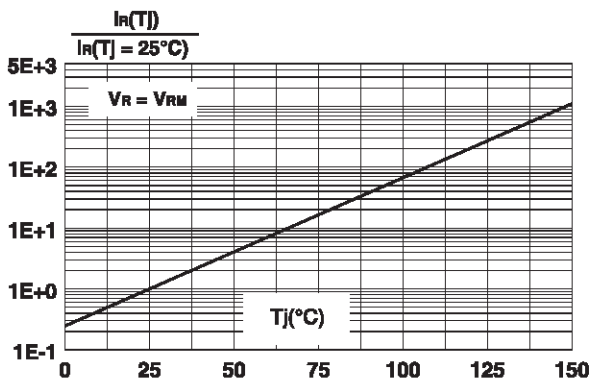
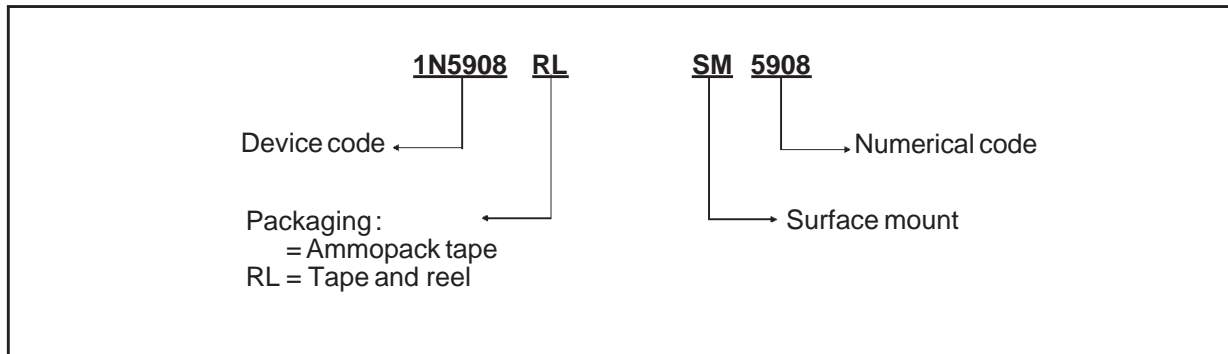

Fig. 7 : Relative variation of leakage current versus junction temperature.



ORDER CODE



MARKING : Logo, type code and cathode band

| Package | Type | Marking |
|---------|--------|---------|
| SMC | SM5908 | MDC |
| CB429 | 1N5908 | 1N5908 |

A white band indicates the cathode

PACKAGE MECHANICAL DATA

SMC (Plastic)

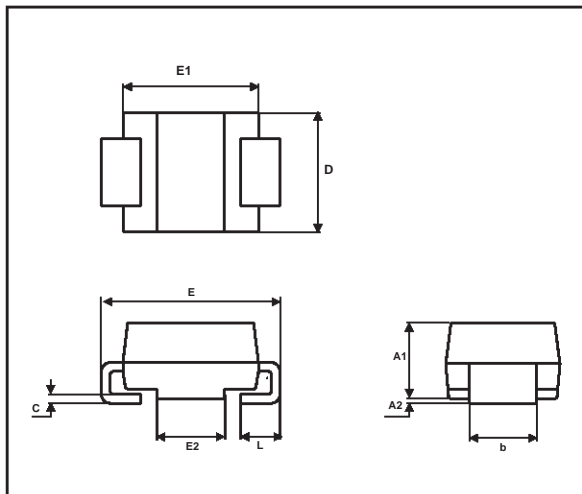

| REF. | DIMENSIONS | | | |
|------|-------------|------|--------|-------|
| | Millimeters | | Inches | |
| | Min. | Max. | Min. | Max. |
| A1 | 1.90 | 2.45 | 0.075 | 0.096 |
| A2 | 0.05 | 0.20 | 0.002 | 0.008 |
| b | 2.90 | 3.2 | 0.114 | 0.126 |
| c | 0.15 | 0.41 | 0.006 | 0.016 |
| E | 7.75 | 8.15 | 0.305 | 0.321 |
| E1 | 6.60 | 7.15 | 0.260 | 0.281 |
| E2 | 4.40 | 4.70 | 0.173 | 0.185 |
| D | 5.55 | 6.25 | 0.218 | 0.246 |
| L | 0.75 | 1.60 | 0.030 | 0.063 |

FOOT PRINT (in millimeters)

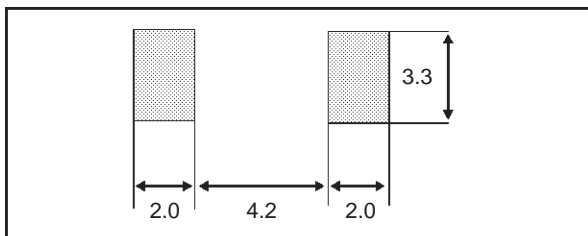

Packaging : Standard packaging is in tape and reel.

Weight = 0.25 g.

1N5908/SM5908

PACKAGE MECHANICAL DATA

CB429 (Plastic)

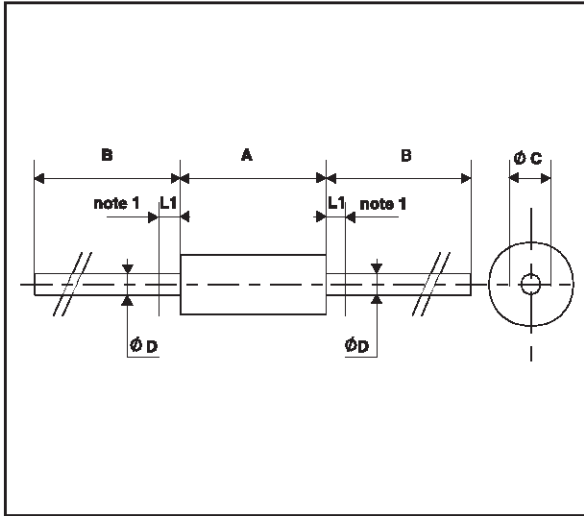

| REF. | DIMENSIONS | | | | | |
|--|-------------|------|------|--------|-------|-------|
| | Millimeters | | | Inches | | |
| | Min. | Typ. | Max. | Min. | Typ. | Max. |
| A | 9.45 | 9.50 | 9.80 | 0.372 | 0.374 | 0.386 |
| B | 26 | | | 1.024 | | |
| Ø C | 4.90 | 5.00 | 5.10 | 0.193 | 0.197 | 0.201 |
| Ø D | 0.94 | 1.00 | 1.06 | 0.037 | 0.039 | 0.042 |
| L1 | | | 1.27 | | | 0.050 |
| Note : The lead is not controlled within zone L ₁ | | | | | | |

Packaging : Standard packaging is in tape and reel.

Weight = 0.85 g.

Information furnished is believed to be accurate and reliable. However, STMicroelectronics assumes no responsibility for the consequences of use of such information nor for any infringement of patents or other rights of third parties which may result from its use. No license is granted by implication or otherwise under any patent or patent rights of STMicroelectronics. Specifications mentioned in this publication are subject to change without notice. This publication supersedes and replaces all information previously supplied. STMicroelectronics products are not authorized for use as critical components in life support devices or systems without express written approval of STMicroelectronics.

The ST logo is a registered trademark of STMicroelectronics

© 1999 STMicroelectronics - Printed in Italy - All rights reserved.

STMicroelectronics GROUP OF COMPANIES

Australia - Brazil - China - Finland - France - Germany - Hong Kong - India - Italy - Japan - Malaysia
Malta - Morocco - Singapore - Spain - Sweden - Switzerland - United Kingdom - U.S.A.

<http://www.st.com>