

Long-life grade capacitors

Applications

- Frequency converters
- Professional power supplies
- Uninterruptible power supplies

Features

- Extremely compact, i. e. high CU product
- High reliability and ripple current capability
- All-welded construction ensures reliable electrical contact
- Version with optimized construction for base cooling (2-pad solution) available
- Version with low-inductance design available

Construction

- Charge-discharge proof, polar
- Aluminum case with insulating sleeve
- Poles with screw terminal connections
- Mounting with ring clips, clamps or threaded stud
- The bases of types with threaded stud and $d \leq 76,9$ mm are not insulated, types with $d = 91$ mm have fully insulated bases

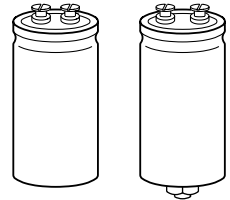

B43456

KAL0567-B

B43458

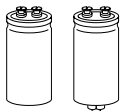

Specifications and characteristics in brief

| | | |
|-------------------------------------------------------------------------------------|------------------------------------------------------------------------------------------------------------------------------------------------------------------|-------------------------------------------------------------------------------------------------------------------------------------------------------------------------------------------------------------------------------------------------------------------------------------------------------------------------|
| Rated voltage U_R | 350 ... 450 VDC | |
| Surge voltage U_S | $1,10 \cdot U_R$ | |
| Rated capacitance C_R | 1 000 ... 18 000 μ F | |
| Capacitance tolerance | $\pm 20 \% \triangleq M$ | |
| Leakage current I_L (5 min, 20 °C) | $I_L \leq 0,3 \mu\text{A} \cdot \left(\frac{C_R}{\mu\text{F}} \cdot \frac{U_R}{V} \right)^{0,7} + 4 \mu\text{A}$ | |
| Self-inductance ESL | Approx. 20 nH Capacitors with low inductance design: $d \geq 64,3$ mm: approx. 13 nH | |
| Useful life 85 °C; U_R ; $I_{\sim R}$ 40 °C; U_R ; $1,5 \cdot I_{\sim R}$ | > 12 000 h > 250 000 h | Requirements: $\Delta C/C \leq \pm 30 \%$ of initial value $ESR \leq 3$ times initial specified limit $I_L \leq$ initial specified limit Failure percentage: $\leq 1 \%$ Failure rate: ≤ 40 fit ($\leq 40 \cdot 10^{-9}/\text{h}$) (for definition "fit", refer to chapter "Quality", page 62) |
| Voltage endurance test 85 °C; U_R | 2 000 h | Post test requirements: $\Delta C/C \leq \pm 10 \%$ of initial value $ESR \leq 1,3$ times initial specified limit $I_L \leq$ initial specified limit |
| Vibration resistance | To IEC 60068-2-6, test Fc: displacement amplitude 0,75 mm, frequency range 10 to 55 Hz, acceleration max. 10 g, duration 3×2 h | |
| IEC climatic category | To IEC 60068-1: $U_R \leq 400$ VDC: 40/085/56 (– 40 °C/+ 85 °C/56 days damp heat test) $U_R = 450$ VDC: 25/085/56 (– 25 °C/+ 85 °C/56 days damp heat test) | |
| Detail specifications | Similar to CECC 30301-803, CECC 30301-807 | |
| Sectional specification | IEC 60384-4 | |

Ripple current capability

Due to the ripple current capability of the contact elements, the following current upper limits must not be exceeded:

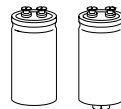
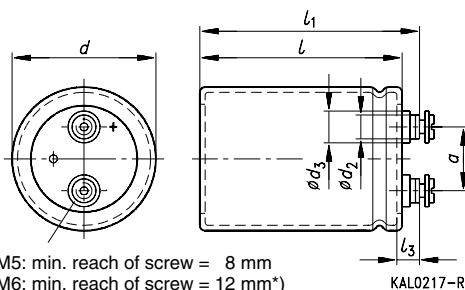
| | | | | |
|-----------------------|---------|---------|---------|---------|
| Capacitor diameter | 51,6 mm | 64,3 mm | 76,9 mm | 91,0 mm |
| $I_{\sim \text{max}}$ | 30 A | 40 A | 50 A | 70 A |

Dimensional drawings
Type B43456
 Ring clip/clamp mounting

M5: min. reach of screw = 8 mm
 M6: min. reach of screw = 12 mm*)
 *) 8 mm for low-inductance design

KAL0217-R

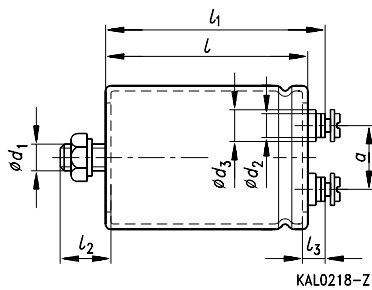
Type B43458
 Threaded stud mounting

KAL0218-Z

Positive pole marking: +

The base of types with threaded stud and $d = 91$ mm is fully insulated (the lengths l and l_1 are increased by 0,5 mm in these cases). For types with threaded stud and $d \leq 76$ mm the base is not insulated. Also refer to the notes on mounting given on page 168.

Screw terminals with UNF threads are available upon request.

Dimensions and weights

| Ter- minal | Dimensions (mm) with insulating sleeve | | | | | | | | | | Approx. wt. (g) |
|---------------|----------------------------------------|-----------|-------------|------------------------------------------------------|---------------|-------|-----------|-----------|--------------------------------------------------------|------|--------------------|
| | d | $l \pm 1$ | $l_1 \pm 1$ | $l_2 \begin{smallmatrix} +0 \\ -1 \end{smallmatrix}$ | l_3 | d_1 | d_2 max | d_3 max | $a \begin{smallmatrix} +0,2 \\ -0,4 \end{smallmatrix}$ | | |
| M 5 | 51,6 +0/-0,8 | 80,7 | 87,2 | 17 | 7,0 +0,2/-1 | M 12 | 8,2 | 13,5 | 22,2 | 220 | |
| M 5 | 51,6 +0/-0,8 | 105,7 | 112,2 | 17 | 7,0 +0,2/-1 | M 12 | 8,2 | 13,5 | 22,2 | 280 | |
| M 5 | 64,3 +0/-0,8 | 105,7 | 112,2 | 17 | 7,0 +0,2/-1 | M 12 | 8,2 | 13,5 | 28,5 | 440 | |
| M 6 | 76,9 +0/-0,7 | 105,7 | 111,5 | 17 | 6,4 +1,1/-0,8 | M 12 | 17,7 | 17,7 | 31,7 | 540 | |
| M 6 | 76,9 +0/-0,7 | 143,2 | 149,0 | 17 | 6,4 +1,1/-0,8 | M 12 | 17,7 | 17,7 | 31,7 | 840 | |
| M 6 | 76,9 +0/-0,7 | 220,7 | 226,5 | 17 | 6,4 +1,1/-0,8 | M 12 | 17,7 | 17,7 | 31,7 | 1300 | |
| M 6 | 91,0 +0/-2 | 144,5 | 149,8 | 17 | 6,4 +1,1/-0,8 | M 12 | 17,7 | 17,7 | 31,7 | 1200 | |
| M 6 | 91,0 +0/-2 | 221,0 | 226,3 | 17 | 6,4 +1,1/-0,8 | M 12 | 17,7 | 17,7 | 31,7 | 1900 | |

Dimensions are also valid for 2-pad solution and low-inductance design.

Packing

For ecological reasons the packing is pure cardboard.

| Capacitor diameter d | Packing units (pieces) | Capacitor diameter d | Packing units (pieces) |
|------------------------|------------------------|------------------------|------------------------|
| 51,6 mm | 22 | 76,9 mm | 12 |
| 64,3 mm | 15 | 91,0 mm | 8 |

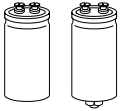

B43456 / B43458

Compact – 85 °C

Special designs

- Low-inductance design
- 2-pad solution

Design for optimized connection of the capacitor to the heatsink when using base cooling. This version is available for capacitors without threaded stud and for diameters $\geq 64,3$ mm (cf. $I_{-R}(B)$ in table “Technical data and ordering codes” and useful life graphs).

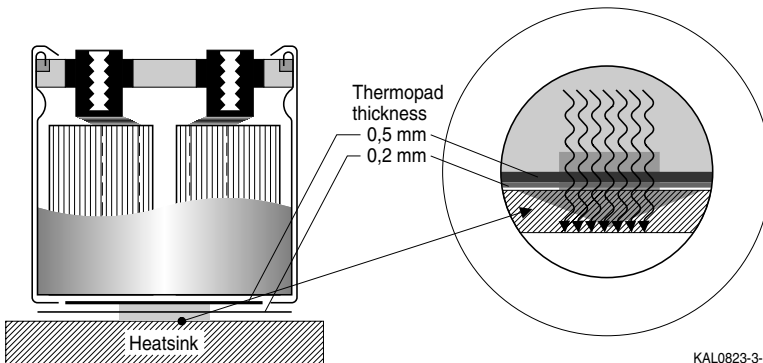

KAL0823-3-E

Ordering codes:

| Design | Identification in 3rd block of ordering code | Remark |
|------------------------|----------------------------------------------|-------------------------------------------------------------------------|
| Low inductance (13 nH) | M003 | For capacitors with diameter $d \geq 64,3$ mm |
| 2-pad solution | M006 | For capacitors with diameter $d \geq 64,3$ mm and without threaded stud |

Accessories

The following items are included in the delivery package, but are not fastened to the capacitors:

| | Thread | Toothed washers | Screws/Nuts | Maximum torque |
|---------------|--------|-----------------|------------------------------------------------|----------------|
| For terminals | M 5 | A 5,1 DIN 6797 | Cylinder-head screw M 5 \times 8 DIN 84-4.8 | 2 Nm |
| | M 6 | A 6,4 DIN 6797 | Cylinder-head screw M 6 \times 12 DIN 85-4.8 | 2,5 Nm |
| For mounting | M 12 | J 12,5 DIN 6797 | Hex nut BM 12 DIN 439 | 10 Nm |

The following must be ordered separately:

Ring clips

B 44 030 (cf. page 169)

Clamps for capacitors with $d \geq 64,3$ mm

B 44 030 (cf. page 173)

Insulating parts

B 44 020 (cf. page 166)

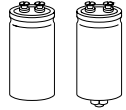
Overview of available types

| U_R (VDC) | 350 | 400 | 450 |
|------------------|-----------------------------------|--------------|--------------|
| C_R (μ F) | Case dimensions $d \times l$ (mm) | | |
| 1 000 | | 51,6 × 80,7 | 51,6 × 80,7 |
| 1 500 | 51,6 × 80,7 | 51,6 × 80,7 | 51,6 × 105,7 |
| 2 200 | 51,6 × 105,7 | 51,6 × 105,7 | 64,3 × 105,7 |
| 3 300 | | 64,3 × 105,7 | 76,9 × 105,7 |
| 3 900 | 64,3 × 105,7 | | |
| 4 700 | | 76,9 × 105,7 | |
| 5 600 | 76,9 × 105,7 | | 76,9 × 143,2 |
| 6 800 | | 76,9 × 143,2 | 91,0 × 144,5 |
| 8 200 | 76,9 × 143,2 | | 76,9 × 220,7 |
| 10 000 | | 91,0 × 144,5 | |
| 12 000 | 91,0 × 144,5 | 76,9 × 220,7 | 91,0 × 221,0 |
| 15 000 | 76,9 × 220,7 | 91,0 × 221,0 | |
| 18 000 | 91,0 × 221,0 | | |

The capacitance and voltage ratings listed above are available in different cases upon request. Other voltage and capacitance ratings are also available upon request.

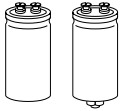
B43456 / B43458
Compact – 85 °C
Technical data and ordering codes

| U_R | C_R 100 Hz 20 °C μF | Case dimensions $d \times l$ mm | ESR_{max} 100 Hz 20 °C mΩ | Z_{max} 10 kHz 20 °C mΩ | $I_{~max}$ 100 Hz 40 °C A | $I_{~R}$ 100 Hz 85 °C A | $I_{~R(B)}$ 100 Hz 85 °C A | Ordering code ¹⁾ |
|-------|--------------------------------|------------------------------------------|--------------------------------------|------------------------------------|------------------------------------|----------------------------------|-------------------------------------|-------------------------------|
| 350 | 1 500 | 51,6 × 80,7 | 110 | 93 | 16 | 5,7 | 11 | B4345*A4158M000 |
| | 2 200 | 51,6 × 105,7 | 73 | 63 | 21 | 7,6 | 14 | B4345*A4228M000 |
| | 3 900 | 64,3 × 105,7 | 41 | 38 | 32 | 12 | 21 | B4345*A4398M000 ²⁾ |
| | 5 600 | 76,9 × 105,7 | 29 | 28 | 43 | 15 | 30 | B4345*A4568M000 ²⁾ |
| | 8 200 | 76,9 × 143,2 | 20 | 20 | 50 | 20 | 36 | B4345*A4828M000 ²⁾ |
| | 12 000 | 91,0 × 144,5 | 14 | 14 | 70 | 28 | 52 | B4345*A4129M000 ²⁾ |
| | 15 000 | 76,9 × 220,7 | 11 | 11 | 50 | 34 | 50 | B4345*A4159M000 ²⁾ |
| | 18 000 | 91,0 × 221,0 | 9 | 9 | 70 | 38 | 58 | B4345*A4189M000 ²⁾ |
| 400 | 1 000 | 51,6 × 80,7 | 160 | 133 | 13 | 4,6 | 8,2 | B4345*A9108M000 |
| | 1 500 | 51,6 × 80,7 | 110 | 93 | 17 | 6,0 | 13 | B4345*A9158M000 |
| | 2 200 | 51,6 × 105,7 | 73 | 63 | 22 | 8,0 | 15 | B4345*A9228M000 |
| | 3 300 | 64,3 × 105,7 | 49 | 44 | 30 | 11 | 20 | B4345*A9338M000 ²⁾ |
| | 4 700 | 76,9 × 105,7 | 34 | 32 | 40 | 14 | 29 | B4345*A9478M000 ²⁾ |
| | 6 800 | 76,9 × 143,2 | 24 | 24 | 50 | 19 | 33 | B4345*A9688M000 ²⁾ |
| | 10 000 | 91,0 × 144,5 | 16 | 16 | 70 | 25 | 48 | B4345*A9109M000 ²⁾ |
| | 12 000 | 76,9 × 220,7 | 14 | 14 | 50 | 31 | 46 | B4345*A9129M000 ²⁾ |
| | 15 000 | 91,0 × 221,0 | 11 | 11 | 70 | 35 | 54 | B4345*A9159M000 ²⁾ |
| 450 | 1 000 | 51,6 × 80,7 | 220 | 190 | 13 | 4,8 | 9,6 | B4345*A5108M000 |
| | 1 500 | 51,6 × 105,7 | 150 | 130 | 18 | 6,5 | 12 | B4345*A5158M000 |
| | 2 200 | 64,3 × 105,7 | 100 | 85 | 24 | 8,4 | 15 | B4345*A5228M000 ²⁾ |
| | 3 300 | 76,9 × 105,7 | 65 | 57 | 32 | 12 | 23 | B4345*A5338M000 ²⁾ |
| | 5 600 | 76,9 × 143,2 | 38 | 35 | 49 | 17 | 31 | B4345*A5568M000 ²⁾ |
| | 6 800 | 91,0 × 144,5 | 32 | 31 | 57 | 20 | 37 | B4345*A5688M000 ²⁾ |
| | 8 200 | 76,9 × 220,7 | 26 | 26 | 50 | 24 | 36 | B4345*A5828M000 ²⁾ |
| | 12 000 | 91,0 × 221,0 | 18 | 18 | 70 | 32 | 51 | B4345*A5129M000 ²⁾ |

Preferred types

1) * "6" = for capacitors with ring clip/clamp mounting

"8" = for capacitors with threaded stud

2) For 2-pad solution (types without threaded stud) and for low-inductance design, see page 128.

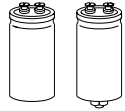

Useful life

depending on ambient temperature T_A (for natural cooling) and versus temperature of case base T_B (for base cooling) under ripple current operating conditions¹⁾

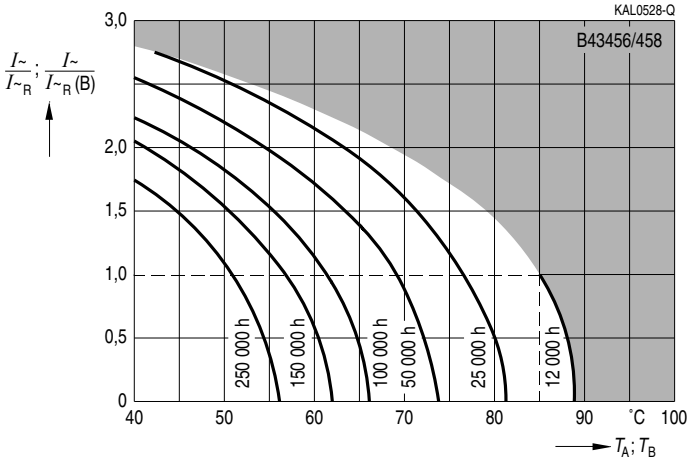

Frequency factor of permissible ripple current I_{\sim} versus frequency f

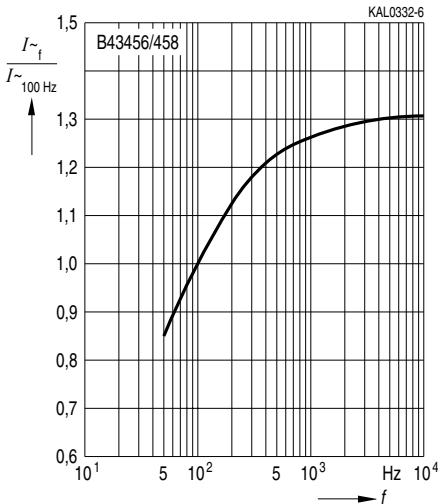

1) The ripple current refers to $I_{\sim R}$ for natural cooling or to $I_{\sim R}(B)$ for base cooling, respectively. Refer to page 40 for an explanation on how to interpret the useful life graphs.

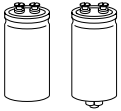

B43456 / B43458

Compact – 85 °C

Frequency characteristics of ESR

Typical behavior

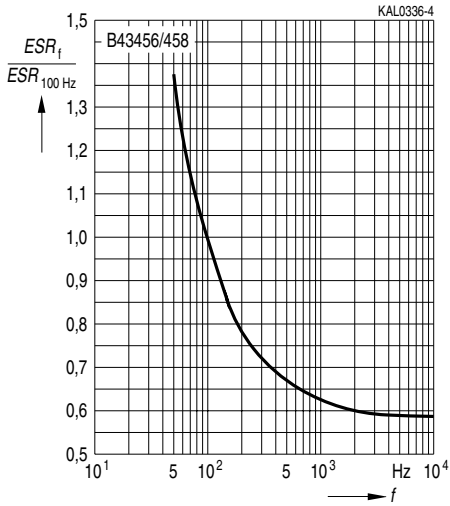

Impedance Z

versus frequency f

Typical behavior at 20 °C

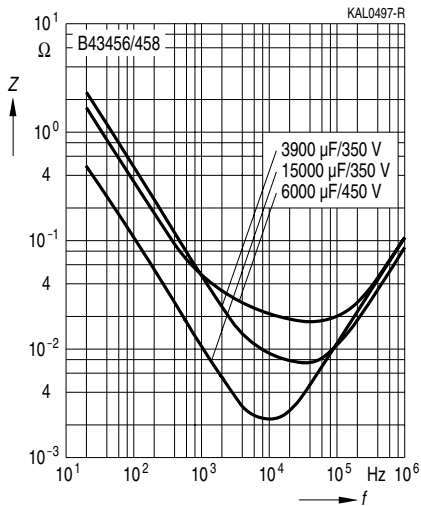

Herausgegeben von EPCOS AG

Unternehmenskommunikation, Postfach 80 17 09, 81617 München, DEUTSCHLAND

☎ ++49 89 636 09, FAX (0 89) 636-2 26 89

© EPCOS AG 2002. Vervielfältigung, Veröffentlichung, Verbreitung und Verwertung dieser Broschüre und ihres Inhalts ohne ausdrückliche Genehmigung der EPCOS AG nicht gestattet.

Bestellungen unterliegen den vom ZVEI empfohlenen Allgemeinen Lieferbedingungen für Erzeugnisse und Leistungen der Elektroindustrie, soweit nichts anderes vereinbart wird.

Diese Broschüre ersetzt die vorige Ausgabe.

Fragen über Technik, Preise und Liefermöglichkeiten richten Sie bitte an den Ihnen nächstgelegenen Vertrieb der EPCOS AG oder an unsere Vertriebsgesellschaften im Ausland. Bauelemente können aufgrund technischer Erfordernisse Gefahrstoffe enthalten. Auskünfte darüber bitten wir unter Angabe des betreffenden Typs ebenfalls über die zuständige Vertriebsgesellschaft einzuholen.

Published by EPCOS AG

Corporate Communications, P.O. Box 80 17 09, 81617 Munich, GERMANY

☎ ++49 89 636 09, FAX (0 89) 636-2 26 89

© EPCOS AG 2002. Reproduction, publication and dissemination of this brochure and the information contained therein without EPCOS' prior express consent is prohibited.

Purchase orders are subject to the General Conditions for the Supply of Products and Services of the Electrical and Electronics Industry recommended by the ZVEI (German Electrical and Electronic Manufacturers' Association), unless otherwise agreed.

This brochure replaces the previous edition.

For questions on technology, prices and delivery please contact the Sales Offices of EPCOS AG or the international Representatives.

Due to technical requirements components may contain dangerous substances. For information on the type in question please also contact one of our Sales Offices.