

**Cool MOS™ Power Transistor**

**Feature**

- New revolutionary high voltage technology
- Worldwide best  $R_{DS(on)}$  in TO 220
- Ultra low gate charge
- Periodic avalanche rated
- Extreme  $dv/dt$  rated
- High peak current capability
- Improved transconductance
- P-TO-220-3-31: Fully isolated package (2500 VAC; 1 minute)

$V_{DS} @ T_{jmax}$	650	V
$R_{DS(on)}$	0.19	$\Omega$
$I_D$	20.7	A

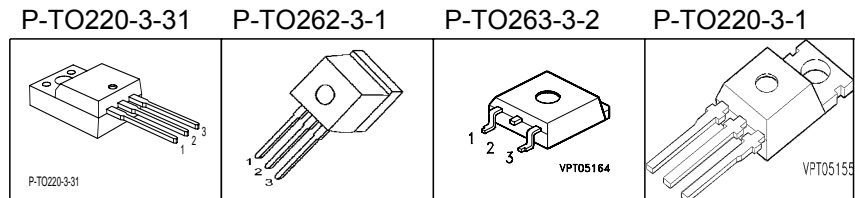

Type	Package	Ordering Code	Marking
SPP20N60C3	P-TO220-3-1	Q67040-S4398	20N60C3
SPB20N60C3	P-TO263-3-2	Q67040-S4397	20N60C3
SPI20N60C3	P-TO262-3-1	Q67040-S4550	20N60C3
SPA20N60C3	P-TO220-3-31	Q67040-S4410	20N60C3

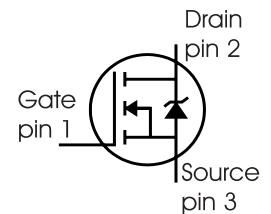

**Maximum Ratings**

Parameter	Symbol	Value		Unit
		SPP	SPA	
Continuous drain current $T_C = 25\text{ }^\circ\text{C}$ $T_C = 100\text{ }^\circ\text{C}$	$I_D$	20.7 13.1	20.7 <sup>1)</sup> 13.1 <sup>1)</sup>	A
Pulsed drain current, $t_p$ limited by $T_{jmax}$	$I_D \text{ puls}$	62.1	62.1	A
Avalanche energy, single pulse $I_D=10\text{A}, V_{DD}=50\text{V}$	$E_{AS}$	690	690	mJ
Avalanche energy, repetitive $t_{AR}$ limited by $T_{jmax}$ <sup>2)</sup> $I_D=20\text{A}, V_{DD}=50\text{V}$	$E_{AR}$	1	1	
Avalanche current, repetitive $t_{AR}$ limited by $T_{jmax}$	$I_{AR}$	20	20	A
Gate source voltage static	$V_{GS}$	$\pm 20$	$\pm 20$	V
Gate source voltage AC ( $f > 1\text{Hz}$ )	$V_{GS}$	$\pm 30$	$\pm 30$	
Power dissipation, $T_C = 25\text{ }^\circ\text{C}$	$P_{tot}$	208	34.5	W
Operating and storage temperature	$T_j, T_{stg}$	-55...+150		$^\circ\text{C}$

**Maximum Ratings**

Parameter	Symbol	Value	Unit
Drain Source voltage slope $V_{DS} = 480\text{ V}, I_D = 20.7\text{ A}, T_j = 125\text{ }^\circ\text{C}$	$dv/dt$	50	V/ns

**Thermal Characteristics**

Parameter	Symbol	Values			Unit
		min.	typ.	max.	
Thermal resistance, junction - case	$R_{thJC}$	-	-	0.6	K/W
Thermal resistance, junction - case, FullPAK	$R_{thJC\text{ FP}}$	-	-	3.6	
Thermal resistance, junction - ambient, leaded	$R_{thJA}$	-	-	62	
Thermal resistance, junction - ambient, FullPAK	$R_{thJA\text{ FP}}$	-	-	80	
SMD version, device on PCB: @ min. footprint @ 6 cm <sup>2</sup> cooling area <sup>3)</sup>	$R_{thJA}$	-	-	62	
Soldering temperature, 1.6 mm (0.063 in.) from case for 10s <sup>4)</sup>	$T_{sold}$	-	-	260	°C

**Electrical Characteristics, at  $T_j=25^\circ\text{C}$  unless otherwise specified**

Parameter	Symbol	Conditions	Values			Unit
			min.	typ.	max.	
Drain-source breakdown voltage	$V_{(BR)DSS}$	$V_{GS}=0\text{V}, I_D=0.25\text{mA}$	600	-	-	V
Drain-Source avalanche breakdown voltage	$V_{(BR)DS}$	$V_{GS}=0\text{V}, I_D=20\text{A}$	-	700	-	
Gate threshold voltage	$V_{GS(th)}$	$I_D=1000\mu\text{A}, V_{GS}=V_{DS}$	2.1	3	3.9	
Zero gate voltage drain current	$I_{DSS}$	$V_{DS}=600\text{V}, V_{GS}=0\text{V},$ $T_j=25^\circ\text{C}$ $T_j=150^\circ\text{C}$	-	0.1	1	$\mu\text{A}$
Gate-source leakage current	$I_{GSS}$	$V_{GS}=30\text{V}, V_{DS}=0\text{V}$	-	-	100	
Drain-source on-state resistance	$R_{DS(on)}$	$V_{GS}=10\text{V}, I_D=13.1\text{A}$ $T_j=25^\circ\text{C}$ $T_j=150^\circ\text{C}$	-	0.16	0.19	$\Omega$
Gate input resistance	$R_G$	$f=1\text{MHz}, \text{open drain}$	-	0.54	-	

**Electrical Characteristics**

Parameter	Symbol	Conditions	Values			Unit
			min.	typ.	max.	
Transconductance	$g_{fs}$	$V_{DS} \geq 2 \cdot I_D \cdot R_{DS(on)max}$ , $I_D = 13.1A$	-	17.5	-	S
Input capacitance	$C_{iss}$	$V_{GS} = 0V$ , $V_{DS} = 25V$ ,	-	2400	-	pF
Output capacitance	$C_{oss}$	$f = 1MHz$	-	780	-	
Reverse transfer capacitance	$C_{rss}$		-	50	-	
Effective output capacitance, <sup>5)</sup> energy related	$C_{o(er)}$	$V_{GS} = 0V$ , $V_{DS} = 0V$ to 480V	-	83	-	
Effective output capacitance, <sup>6)</sup> time related	$C_{o(tr)}$		-	160	-	
Turn-on delay time	$t_{d(on)}$	$V_{DD} = 380V$ , $V_{GS} = 0/13V$ , $I_D = 20.7A$ , $R_G = 3.6\Omega$ , $T_j = 125$	-	10	-	ns
Rise time	$t_r$	$V_{DD} = 380V$ , $V_{GS} = 0/13V$ ,	-	5	-	
Turn-off delay time	$t_{d(off)}$	$I_D = 20.7A$ ,	-	67	100	
Fall time	$t_f$	$R_G = 3.6\Omega$	-	4.5	12	

**Gate Charge Characteristics**

Gate to source charge	$Q_{gs}$	$V_{DD} = 480V$ , $I_D = 20.7A$	-	11	-	nC
Gate to drain charge	$Q_{gd}$		-	33	-	
Gate charge total	$Q_g$	$V_{DD} = 480V$ , $I_D = 20.7A$ , $V_{GS} = 0$ to 10V	-	87	114	
Gate plateau voltage	$V_{(plateau)}$	$V_{DD} = 480V$ , $I_D = 20.7A$	-	5.5	-	V

<sup>1</sup>Limited only by maximum temperature

<sup>2</sup>Repetitive avalanche causes additional power losses that can be calculated as  $P_{AV} = E_{AR} \cdot f$ .

<sup>3</sup>Device on 40mm\*40mm\*1.5mm epoxy PCB FR4 with 6cm<sup>2</sup> (one layer, 70 μm thick) copper area for drain connection. PCB is vertical without blown air.

<sup>4</sup>Soldering temperature for TO-263: 220°C, reflow

<sup>5</sup> $C_{o(er)}$  is a fixed capacitance that gives the same stored energy as  $C_{oss}$  while  $V_{DS}$  is rising from 0 to 80%  $V_{DSS}$ .

<sup>6</sup> $C_{o(tr)}$  is a fixed capacitance that gives the same charging time as  $C_{oss}$  while  $V_{DS}$  is rising from 0 to 80%  $V_{DSS}$ .

**Electrical Characteristics**

Parameter	Symbol	Conditions	Values			Unit
			min.	typ.	max.	
Inverse diode continuous forward current	$I_S$	$T_C=25^\circ\text{C}$	-	-	20.7	A
Inverse diode direct current, pulsed	$I_{SM}$		-	-	62.1	
Inverse diode forward voltage	$V_{SD}$	$V_{GS}=0\text{V}, I_F=I_S$	-	1	1.2	V
Reverse recovery time	$t_{rr}$	$V_R=480\text{V}, I_F=I_S,$	-	500	800	ns
Reverse recovery charge	$Q_{rr}$	$di_F/dt=100\text{A}/\mu\text{s}$	-	11	-	$\mu\text{C}$
Peak reverse recovery current	$I_{rrm}$		-	70	-	A
Peak rate of fall of reverse recovery current	$di_{rr}/dt$	$T_j=25^\circ\text{C}$	-	1400	-	$\text{A}/\mu\text{s}$

**Typical Transient Thermal Characteristics**

Symbol	Value		Unit	Symbol	Value		Unit
	SPP_B_I	SPA			SPP_B_I	SPA	
$R_{th1}$	0.00769	0.00769	K/W	$C_{th1}$	0.0003763	0.0003763	Ws/K
$R_{th2}$	0.015	0.015		$C_{th2}$	0.001411	0.001411	
$R_{th3}$	0.029	0.029		$C_{th3}$	0.001931	0.001931	
$R_{th4}$	0.114	0.163		$C_{th4}$	0.005297	0.005297	
$R_{th5}$	0.136	0.323		$C_{th5}$	0.012	0.008453	
$R_{th6}$	0.059	2.526		$C_{th6}$	0.091	0.412	

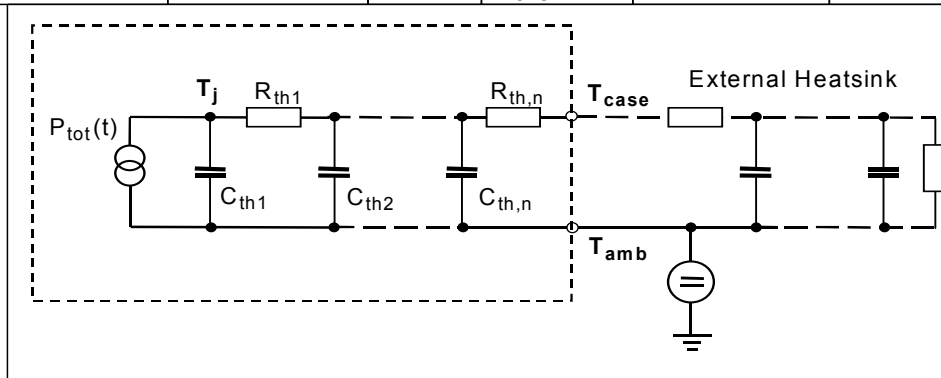

**1 Power dissipation**

$P_{tot} = f(T_C)$

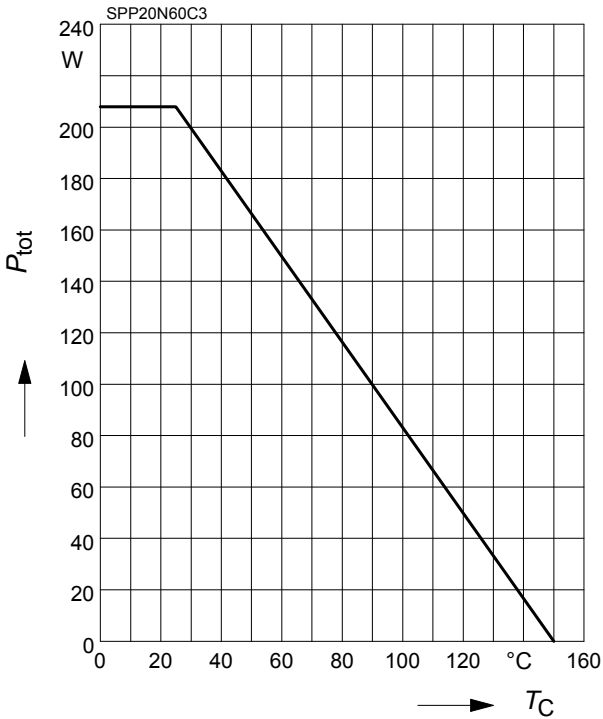

**2 Power dissipation FullPAK**

$P_{tot} = f(T_C)$

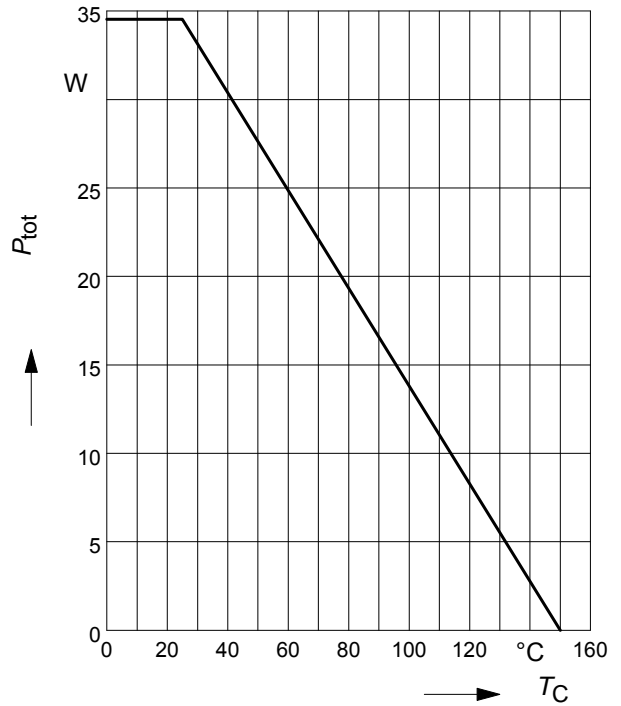

**3 Safe operating area**

$I_D = f(V_{DS})$

parameter :  $D = 0$  ,  $T_C = 25^\circ\text{C}$

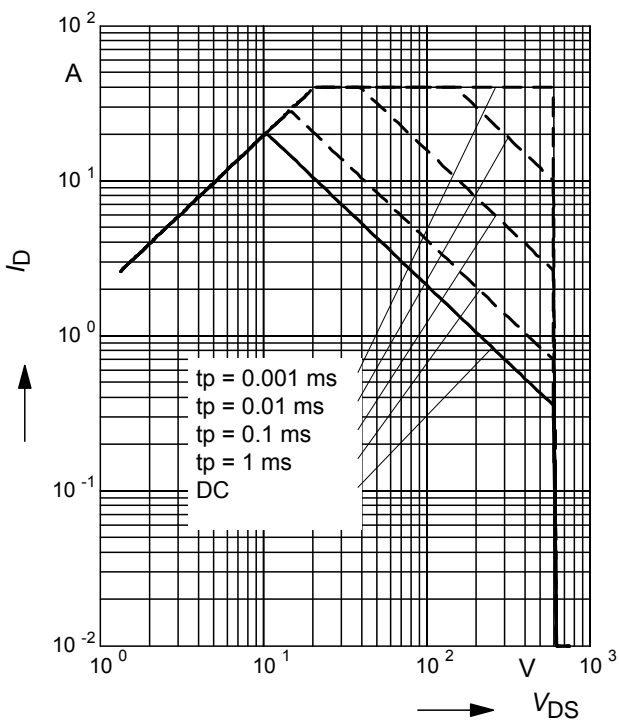

**4 Safe operating area FullPAK**

$I_D = f(V_{DS})$

parameter:  $D = 0$  ,  $T_C = 25^\circ\text{C}$

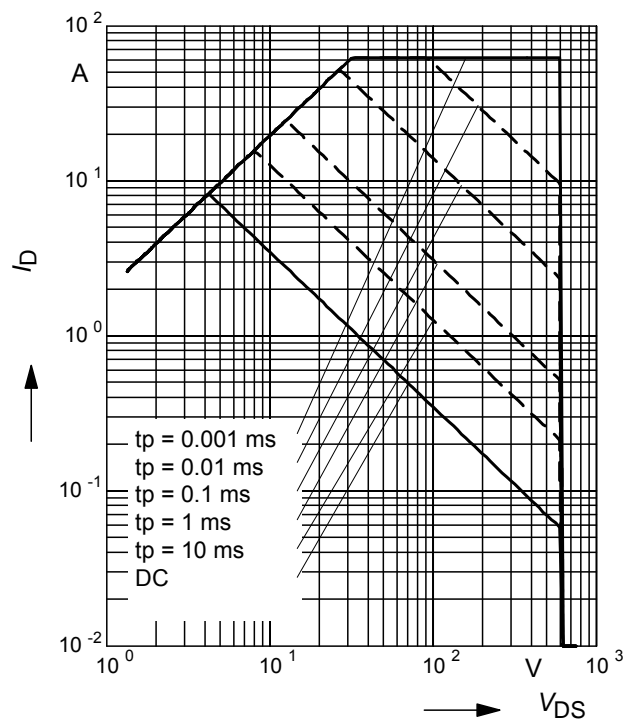

**5 Transient thermal impedance**

$Z_{thJC} = f(t_p)$

parameter:  $D = t_p/T$

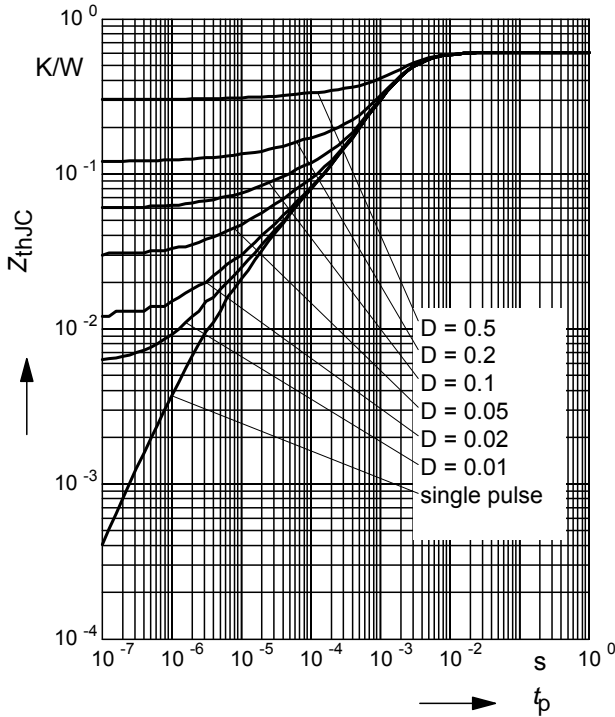

**6 Transient thermal impedance FullPAK**

$Z_{thJC} = f(t_p)$

parameter:  $D = t_p/t$

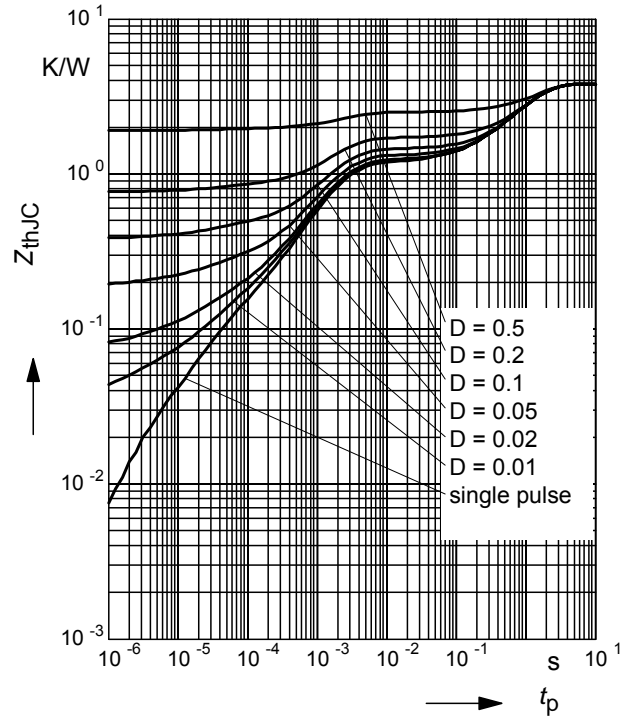

**7 Typ. output characteristic**

$I_D = f(V_{DS}); T_j = 25^\circ C$

parameter:  $t_p = 10 \mu s, V_{GS}$

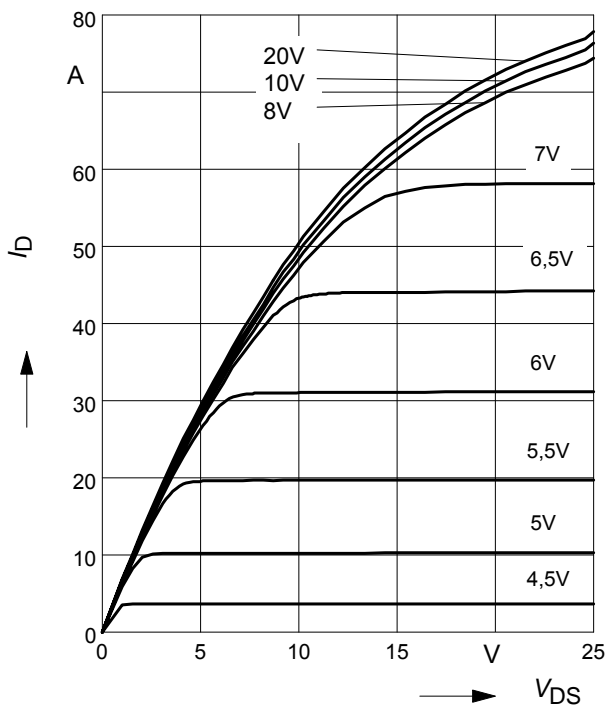

**8 Typ. output characteristic**

$I_D = f(V_{DS}); T_j = 150^\circ C$

parameter:  $t_p = 10 \mu s, V_{GS}$

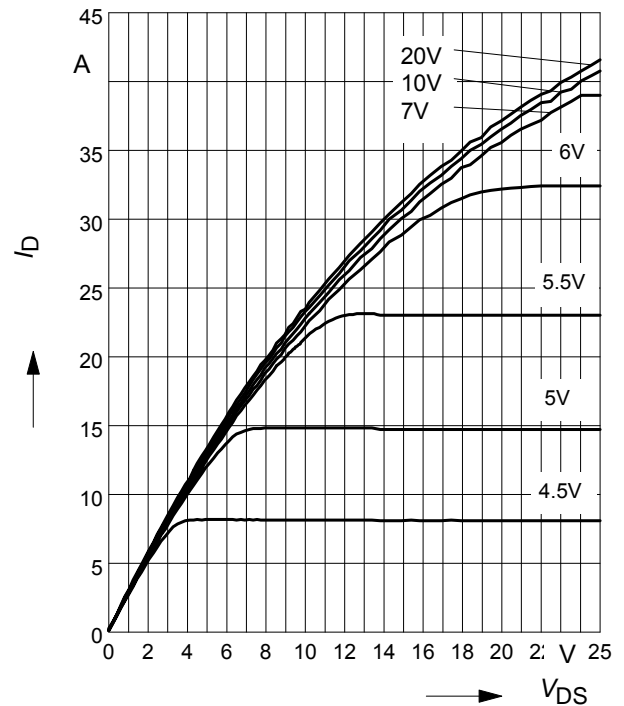

**9 Typ. drain-source on resistance**

$$R_{DS(on)} = f(I_D)$$

parameter:  $T_j = 150^\circ\text{C}$ ,  $V_{GS}$

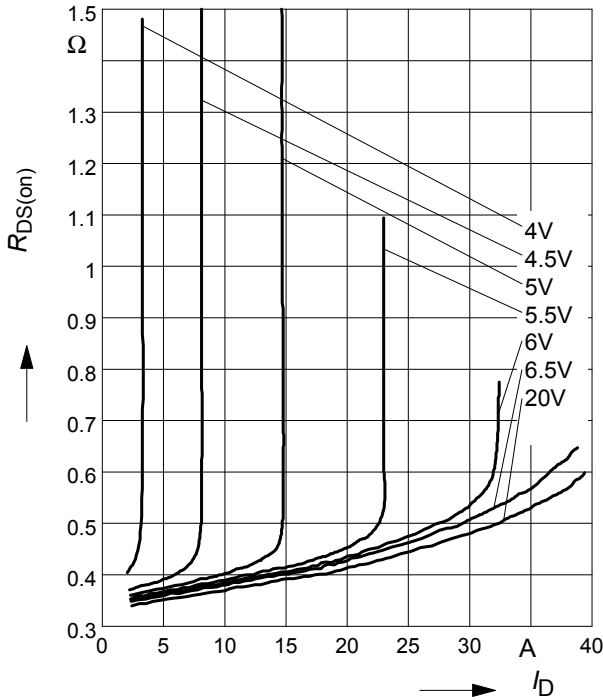

**10 Drain-source on-state resistance**

$$R_{DS(on)} = f(T_j)$$

parameter:  $I_D = 13.1\text{ A}$ ,  $V_{GS} = 10\text{ V}$

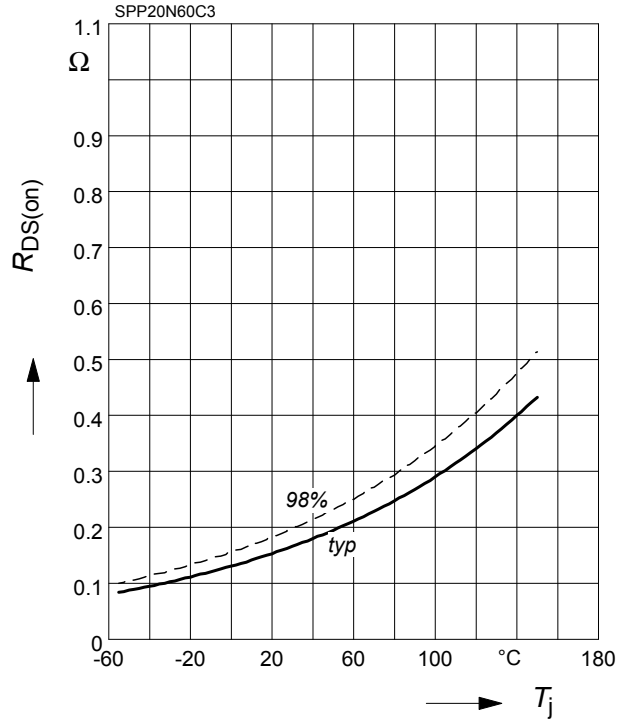

**11 Typ. transfer characteristics**

$$I_D = f(V_{GS}); V_{DS} \geq 2 \times I_D \times R_{DS(on)max}$$

parameter:  $t_p = 10\ \mu\text{s}$

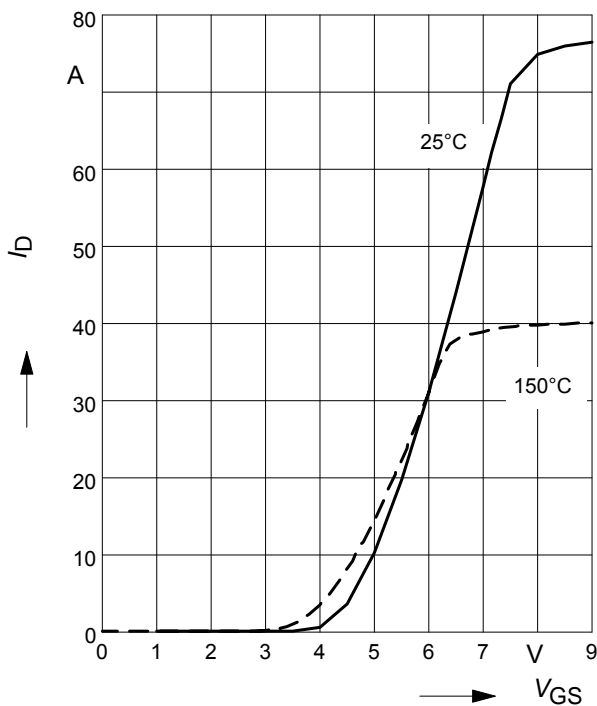

**12 Typ. gate charge**

$$V_{GS} = f(Q_{Gate})$$

parameter:  $I_D = 20.7\text{ A pulsed}$

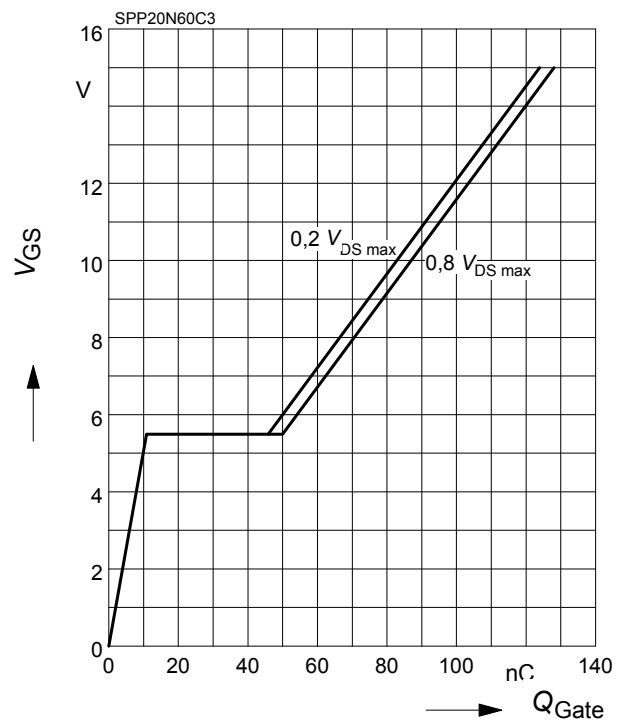

**13 Forward characteristics of body diode**

$I_F = f(V_{SD})$

parameter:  $T_j$ ,  $t_p = 10 \mu s$

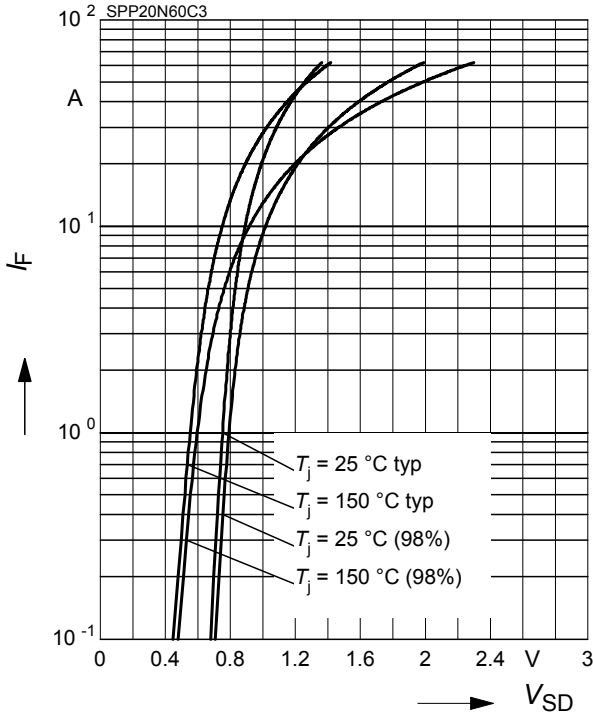

**14 Typ. switching time**

$t = f(I_D)$ , inductive load,  $T_j = 125^\circ C$

par.:  $V_{DS} = 380V$ ,  $V_{GS} = 0/+13V$ ,  $R_G = 3.6\Omega$

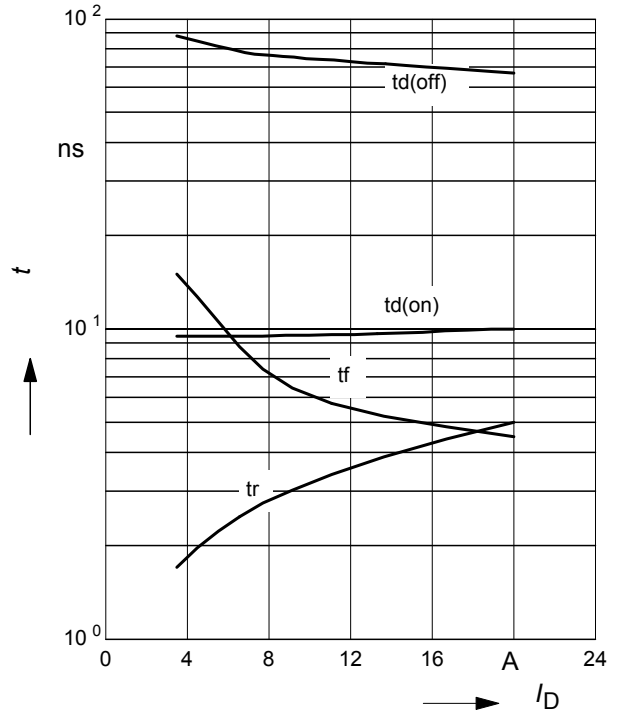

**15 Typ. switching time**

$t = f(R_G)$ , inductive load,  $T_j = 125^\circ C$

par.:  $V_{DS} = 380V$ ,  $V_{GS} = 0/+13V$ ,  $I_D = 20.7 A$

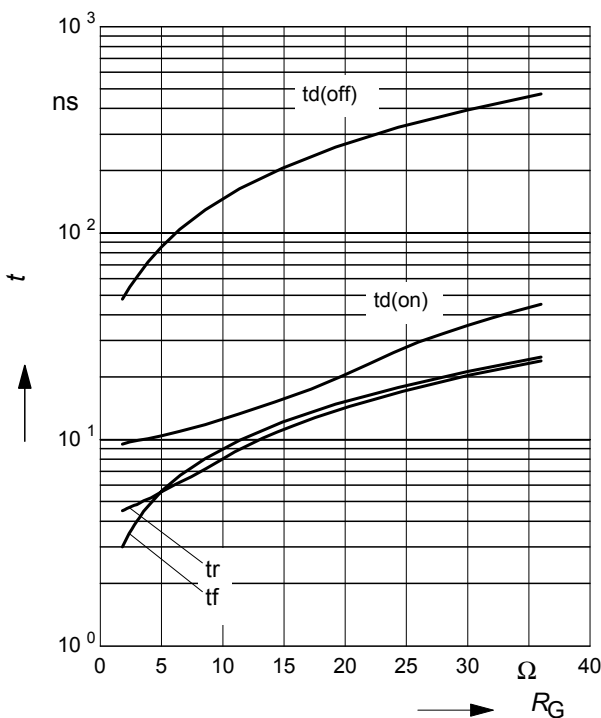

**16 Typ. drain current slope**

$di/dt = f(R_G)$ , inductive load,  $T_j = 125^\circ C$

par.:  $V_{DS} = 380V$ ,  $V_{GS} = 0/+13V$ ,  $I_D = 20.7A$

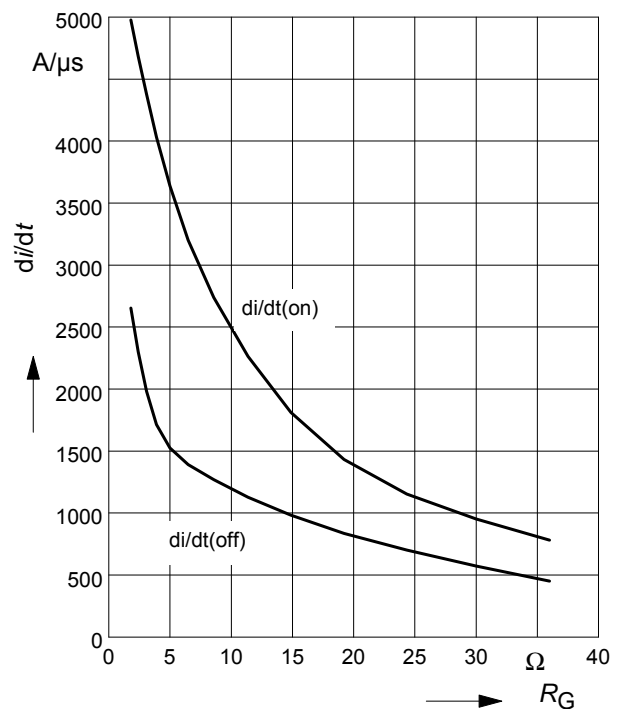



**17 Typ. drain source voltage slope**

$dv/dt = f(R_G)$ , inductive load,  $T_j = 125^\circ\text{C}$   
par.:  $V_{DS}=380\text{V}$ ,  $V_{GS}=0/+13\text{V}$ ,  $I_D=20.7\text{A}$

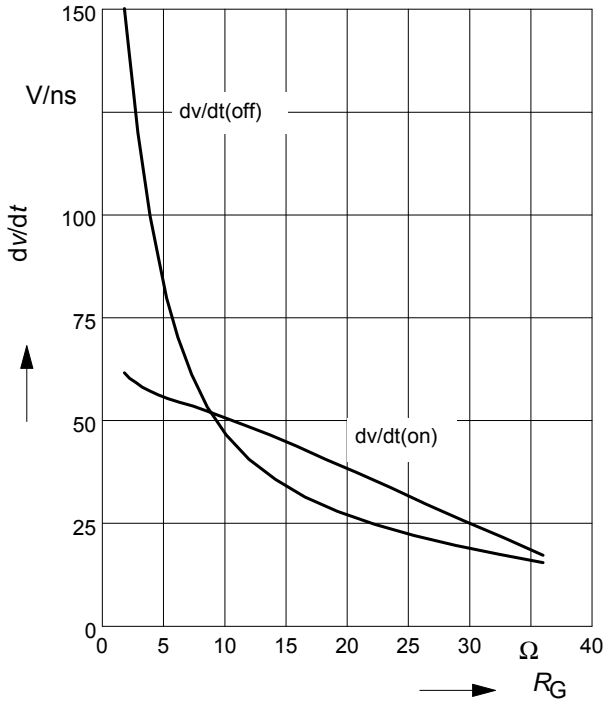

**18 Typ. switching losses**

$E = f(I_D)$ , inductive load,  $T_j=125^\circ\text{C}$   
par.:  $V_{DS}=380\text{V}$ ,  $V_{GS}=0/+13\text{V}$ ,  $R_G=3.6\Omega$

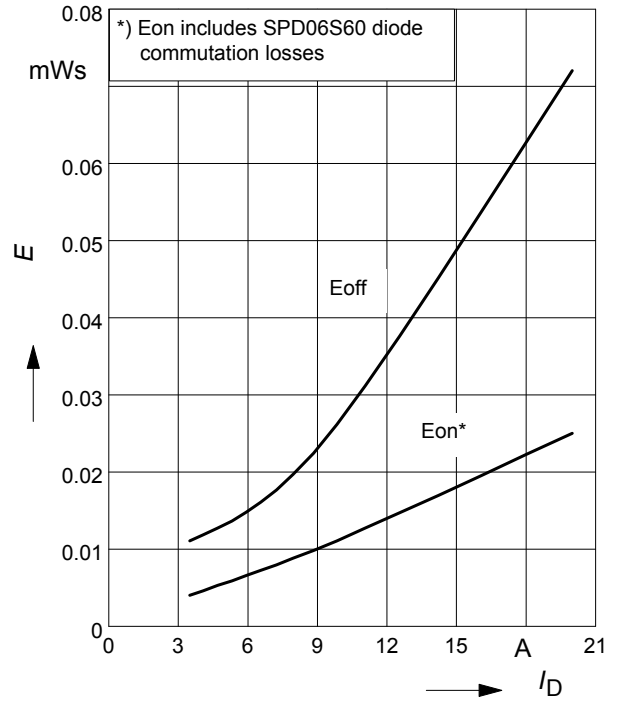

**19 Typ. switching losses**

$E = f(R_G)$ , inductive load,  $T_j=125^\circ\text{C}$   
par.:  $V_{DS}=380\text{V}$ ,  $V_{GS}=0/+13\text{V}$ ,  $I_D=20.7\text{A}$

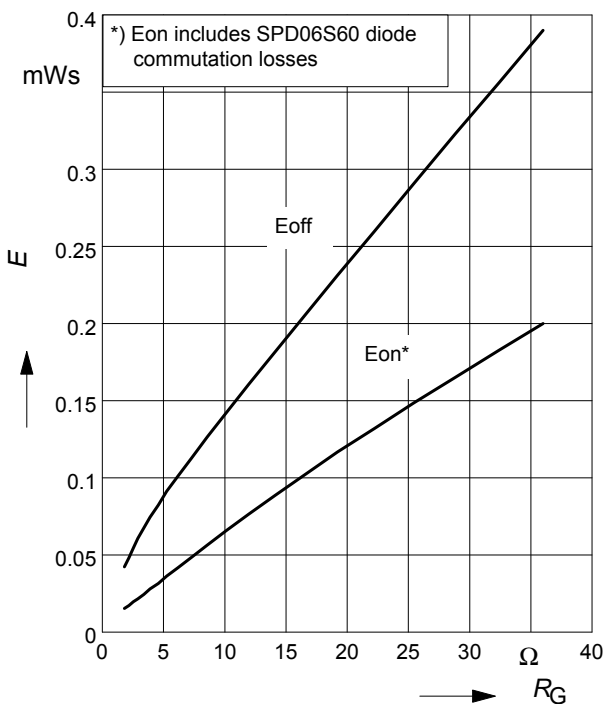

**20 Avalanche SOA**

$I_{AR} = f(t_{AR})$   
par.:  $T_j \leq 150^\circ\text{C}$

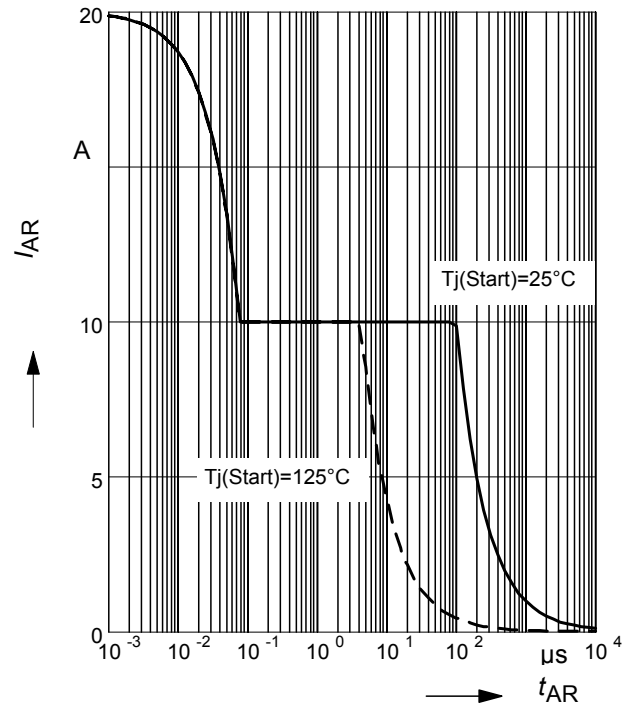

**21 Avalanche energy**

$$E_{AS} = f(T_j)$$

par.:  $I_D = 10\text{ A}$ ,  $V_{DD} = 50\text{ V}$

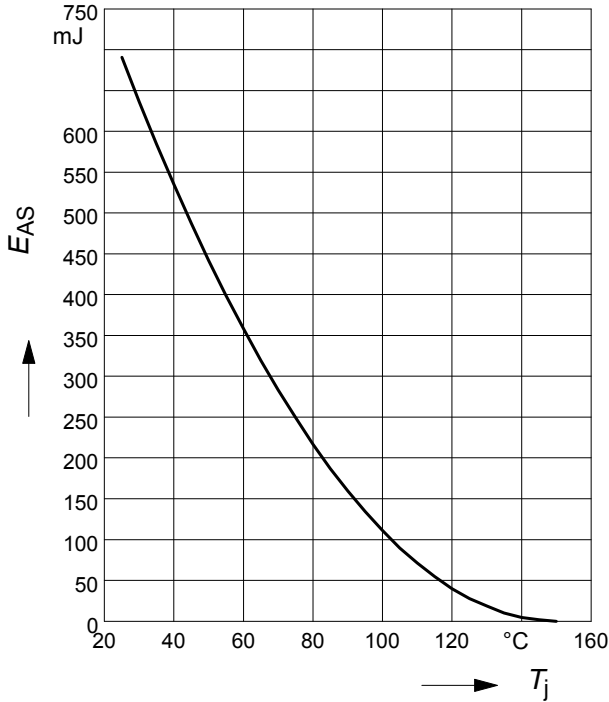

**22 Drain-source breakdown voltage**

$$V_{(BR)DSS} = f(T_j)$$

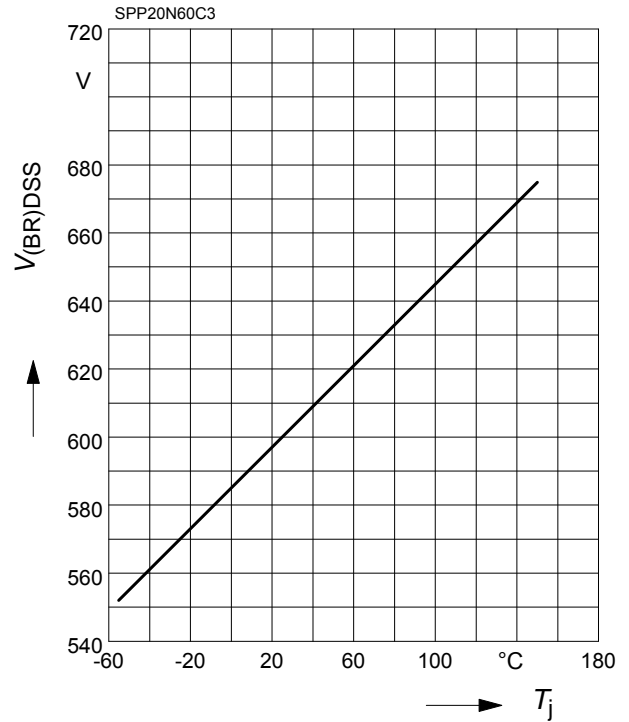

**23 Avalanche power losses**

$$P_{AR} = f(f)$$

parameter:  $E_{AR} = 1\text{ mJ}$

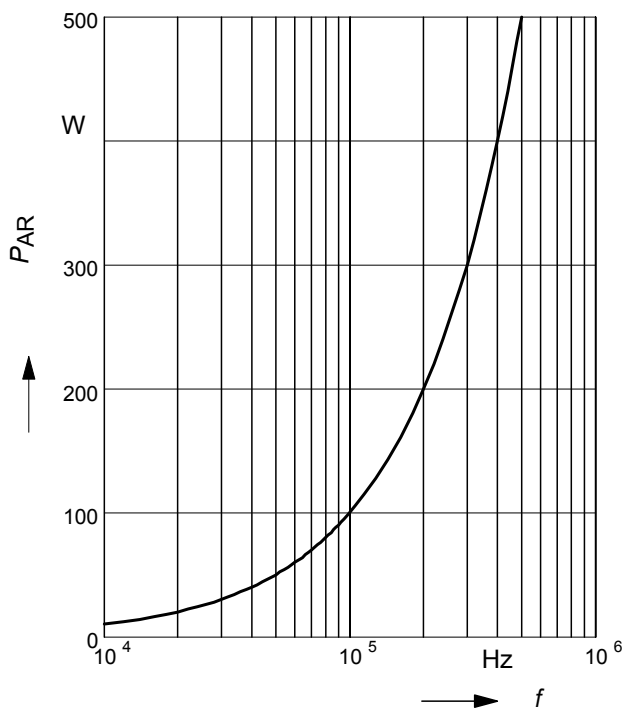

**24 Typ. capacitances**

$$C = f(V_{DS})$$

parameter:  $V_{GS} = 0\text{ V}$ ,  $f = 1\text{ MHz}$

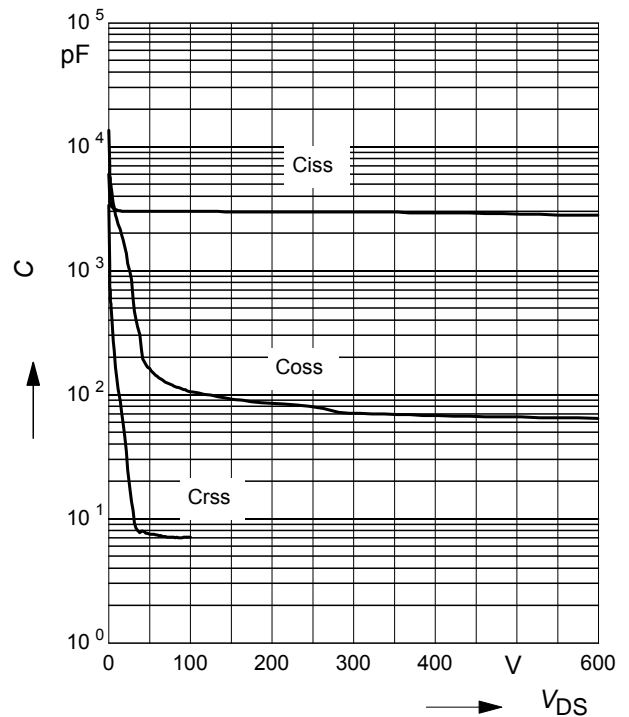

25 Typ.  $C_{OSS}$  stored energy

$$E_{OSS} = f(V_{DS})$$

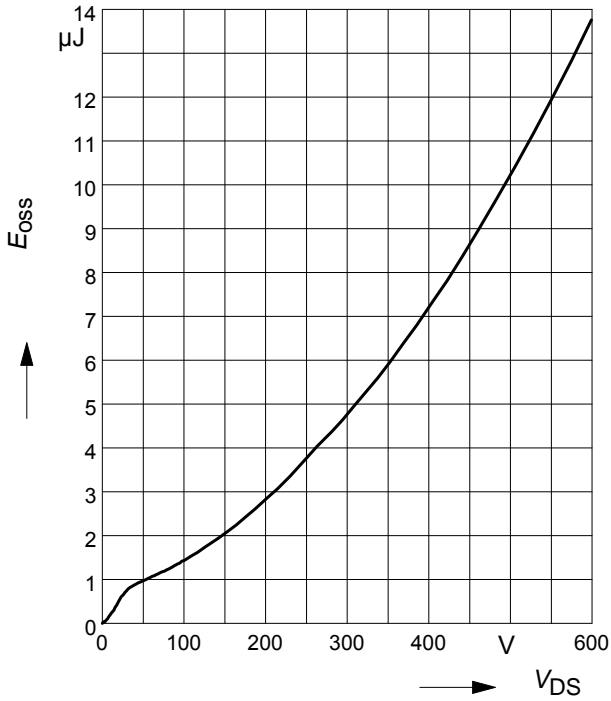

Definition of diodes switching characteristics

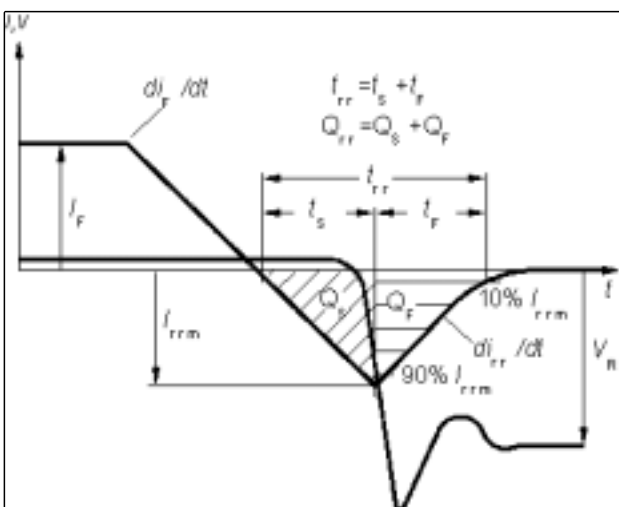

P-TO-220-3-1

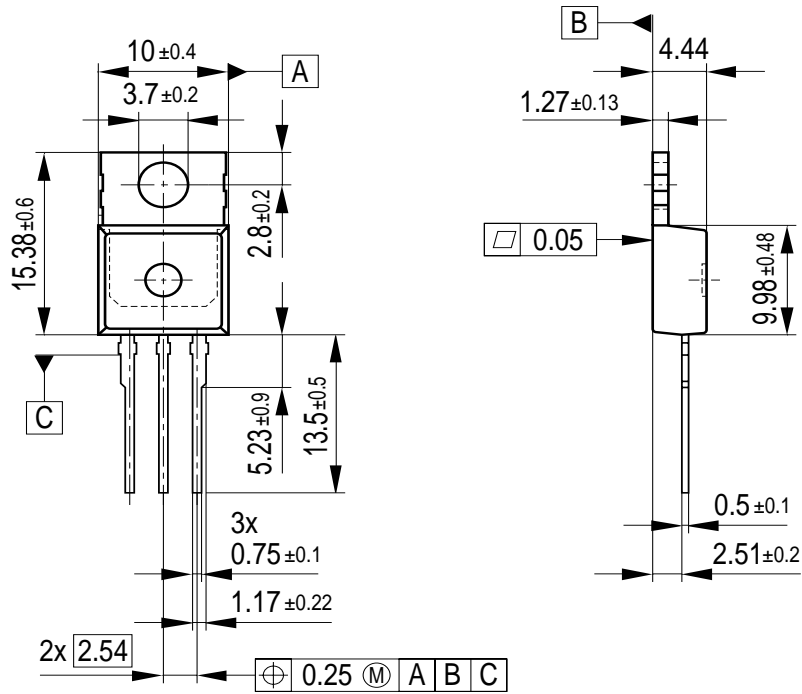

All metal surfaces tin plated, except area of cut.  
Metal surface min. x=7.25, y=12.3

P-TO-263-3-2 (D<sup>2</sup>-PAK)

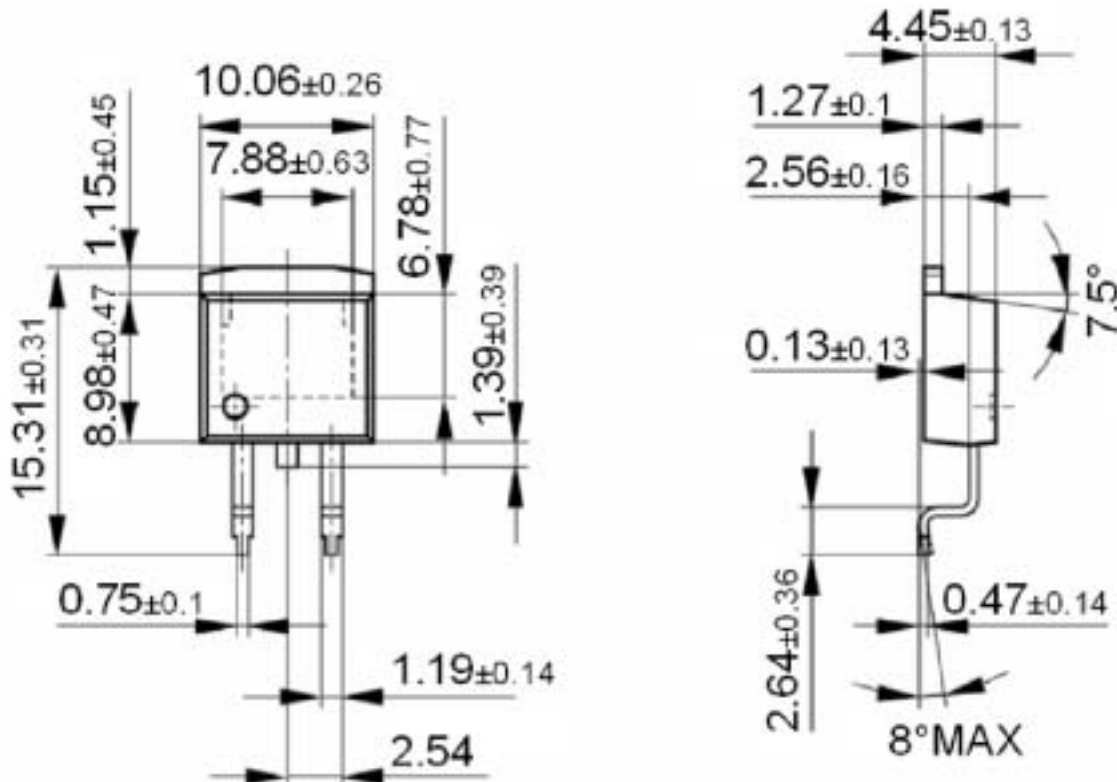

P-TO-262-3-1 (I<sup>2</sup>-PAK)

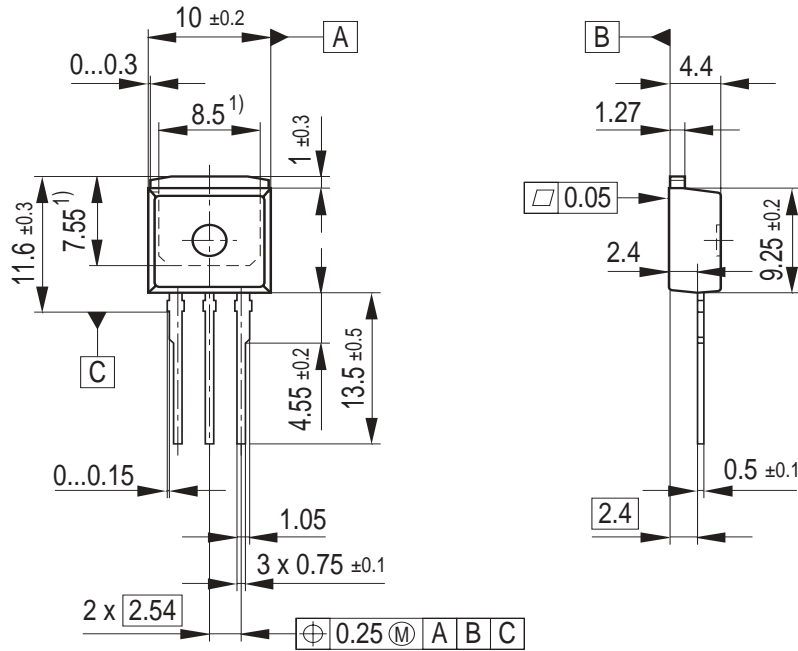

1) Typical

Metal surface min. X = 7.25, Y = 6.9

All metal surfaces tin plated, except area of cut.

P-TO-220-3-31 (FullPAK)

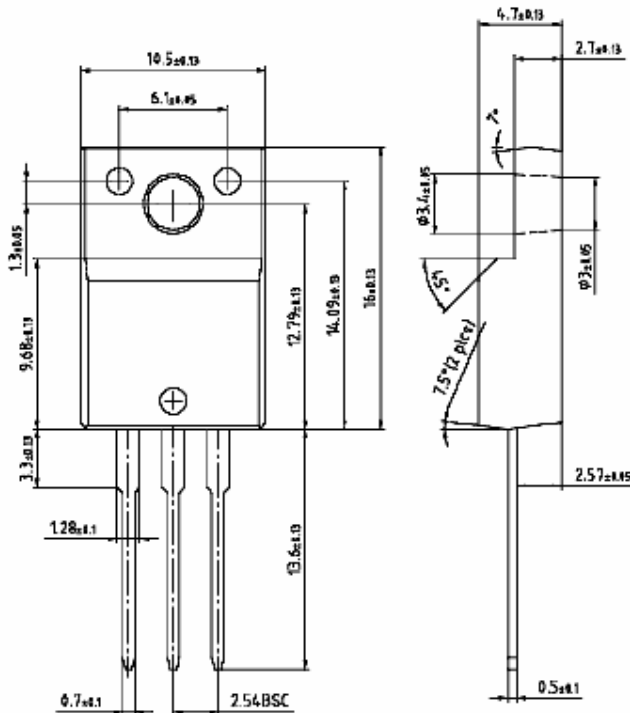

Please refer to mounting instructions (application note AN-TO220-3-31-01)

**Published by**  
**Infineon Technologies AG,**  
**Bereichs Kommunikation**  
**St.-Martin-Strasse 53,**  
**D-81541 München**  
**© Infineon Technologies AG 1999**  
**All Rights Reserved.**

**Attention please!**

The information herein is given to describe certain components and shall not be considered as warranted characteristics.

Terms of delivery and rights to technical change reserved.

We hereby disclaim any and all warranties, including but not limited to warranties of non-infringement, regarding circuits, descriptions and charts stated herein.

Infineon Technologies is an approved CECC manufacturer.

**Information**

For further information on technology, delivery terms and conditions and prices please contact your nearest Infineon Technologies Office in Germany or our Infineon Technologies Representatives worldwide (see address list).

**Warnings**

Due to technical requirements components may contain dangerous substances.

For information on the types in question please contact your nearest Infineon Technologies Office.

Infineon Technologies Components may only be used in life-support devices or systems with the express written approval of Infineon Technologies, if a failure of such components can reasonably be expected to cause the failure of that life-support device or system, or to affect the safety or effectiveness of that device or system. Life support devices or systems are intended to be implanted in the human body, or to support and/or maintain and sustain and/or protect human life. If they fail, it is reasonable to assume that the health of the user or other persons may be endangered.