

CD40192B, CD40193B Types

CMOS Presetable Up/Down Counters (Dual Clock With Reset)

High-Voltage Types (20-Volt Rating)

CD40192 – BCD Type

CD40193 – Binary Type

■ CD40192B Presetable BCD Up/Down Counter and the CD40193B Presetable Binary Up/Down Counter each consist of 4 synchronously clocked, gated "D" type flip-flops connected as a counter. The inputs consist of 4 individual jam lines, a PRESET ENABLE control, individual CLOCK UP and CLOCK DOWN signals and a master RESET. Four buffered Q signal outputs as well as CARRY and BORROW outputs for multiple-stage counting schemes are provided.

The counter is cleared so that all outputs are in a low state by a high on the RESET line. A RESET is accomplished asynchronously with the clock. Each output is individually programmable asynchronously with the clock to the level on the corresponding jam input when the PRESET ENABLE control is low.

The counter counts up one count on the positive clock edge of the CLOCK UP signal provided the CLOCK DOWN line is high. The counter counts down one count on the positive clock edge of the CLOCK DOWN signal provided the CLOCK UP line is high.

The CARRY and BORROW signals are high when the counter is counting up or down. The CARRY signal goes low one-half clock cycle after the counter reaches its maximum count in the count-up mode. The BORROW signal goes low one-half clock cycle after the counter reaches its minimum count in the count-down mode. Cascading of multiple packages is easily accomplished without the need for additional external circuitry by tying the BORROW and CARRY outputs to the CLOCK DOWN and CLOCK UP inputs, respectively, of the succeeding counter package.

The CD40192B and CD40193B types are supplied in 16-lead hermetic dual-in-line ceramic packages (F3A suffix), 16-lead dual-in-line plastic packages (E suffix), 16-lead small-outline packages (NSR suffix), and 16-lead thin shrink small-outline packages (PW and PWR suffixes).

Features:

- Individual clock lines for counting up or counting down
- Synchronous high-speed carry and borrow propagation delays for cascading
- Asynchronous reset and preset capability
- Medium-speed operation— $f_{CL} = 8 \text{ MHz (typ.) @ } 10 \text{ V}$
- 5-V, 10-V, and 15-V parametric ratings
- Standardized, symmetrical output characteristics
- 100% tested for quiescent current at 20 V
- Maximum input current of $1 \mu\text{A}$ at 18 V over full package temperature range; 100 nA at 18 V and 25°C
- Noise margin over full package temperature range:
1 V at $V_{DD} = 5 \text{ V}$ 2 V at $V_{DD} = 10 \text{ V}$
2.5 V at $V_{DD} = 15 \text{ V}$

- Meets all requirements of JEDEC Tentative Standard No. 13B, "Standard Specifications for Description of 'B' Series CMOS Devices"

Applications:

- Up/down difference counting
- Multistage ripple counting
- Synchronous frequency dividers
- A/D and D/A conversion
- Programmable binary or BCD counting

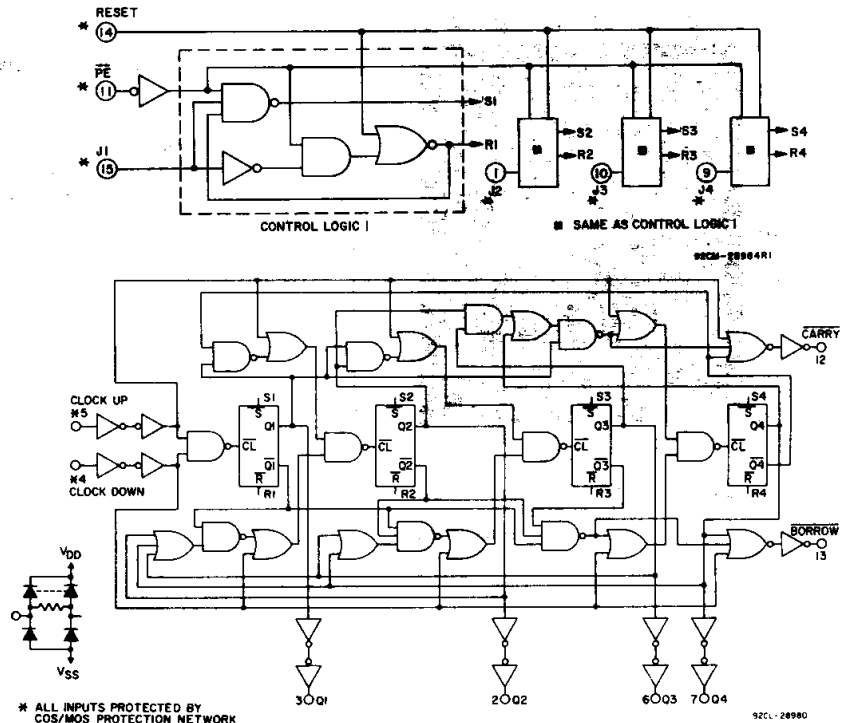
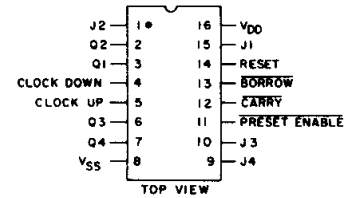
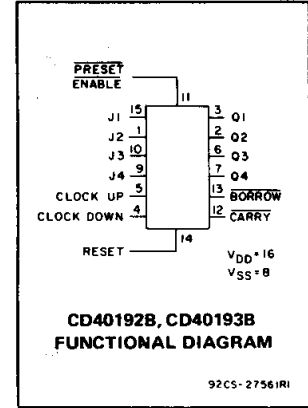

Fig. 1 – CD40192B logic diagram (BCD).

CD40192B, CD40193B Types

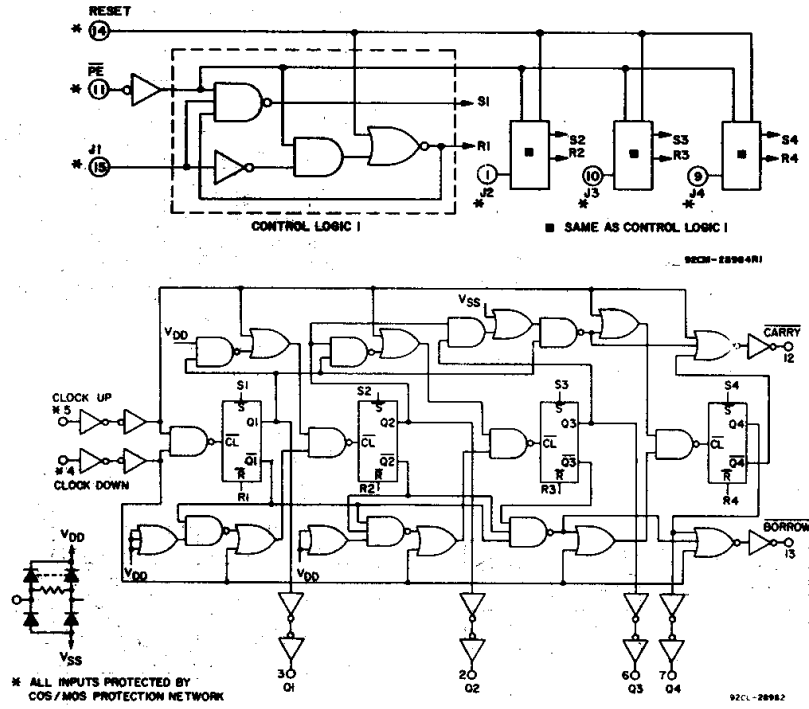

Fig. 2 - CD40193B logic diagram (binary).

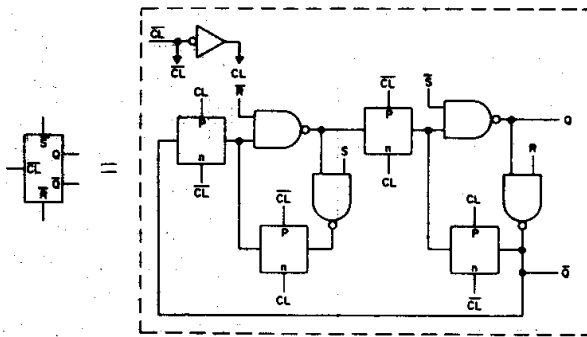

Fig. 4 - Internal logic of Flip-flop.

TRUTH TABLE

CLOCK UP	CLOCK DOWN	PRESET ENABLE	RESET	ACTION
	1	1	0	COUNT UP
	1	1	0	NO COUNT
1		1	0	COUNT DOWN
1		1	0	NO COUNT
X	X	0	0	PRESET
X	X	X	1	RESET

1 = HIGH LEVEL

0 = LOW LEVEL

X = DON'T CARE

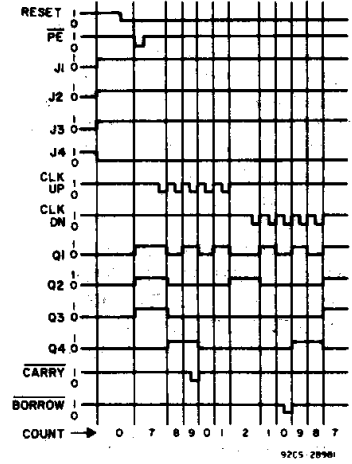

Fig. 3 - CD40192B timing diagram.

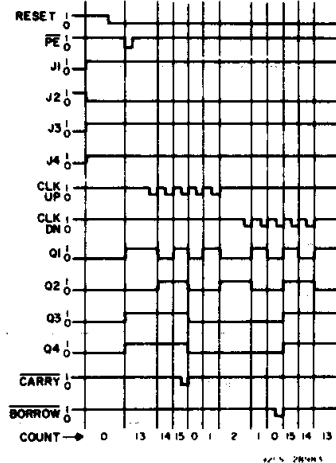

Fig. 5 - CD40193B timing diagram.

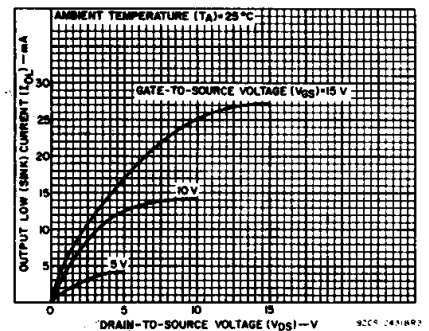

Fig. 6 - Typical output low (sink) current characteristics.

3
COMMERCIAL CMOS
HIGH VOLTAGE ICs

CD40192B, CD40193B Types

MAXIMUM RATINGS, Absolute-Maximum Values:

DC SUPPLY-VOLTAGE RANGE, (V_{DD})	
Voltages referenced to V_{SS} Terminal)	-0.5V to +20V
INPUT VOLTAGE RANGE, ALL INPUTS	-0.5V to $V_{DD} + 0.5V$
DC INPUT CURRENT, ANY ONE INPUT	$\pm 10mA$
POWER DISSIPATION PER PACKAGE (P_D):	
For $T_A = -55^\circ C$ to $+100^\circ C$	500mW
For $T_A = +100^\circ C$ to $+125^\circ C$	Derate Linearly at 12mW/ $^\circ C$ to 200mW
DEVICE DISSIPATION PER OUTPUT TRANSISTOR	
FOR $T_A =$ FULL PACKAGE-TEMPERATURE RANGE (All Package Types)	100mW
OPERATING-TEMPERATURE RANGE (T_A)	$-55^\circ C$ to $+125^\circ C$
STORAGE TEMPERATURE RANGE (T_{stg})	$-65^\circ C$ to $+150^\circ C$
LEAD TEMPERATURE (DURING SOLDERING):	
At distance $1/16 \pm 1/32$ Inch ($1.59 \pm 0.79mm$) from case for 10s max	$+265^\circ C$

RECOMMENDED OPERATING CONDITIONS at $T_A = 25^\circ C$ (unless otherwise specified)

For maximum reliability, nominal operating conditions should be selected so that operation is always within the following ranges.

CHARACTERISTIC	V_{DD} (V)	LIMITS		UNITS
		Min.	Max.	
Supply Voltage Range (For $T_A =$ Full Temp. Range)	-	3	18	V
Removal Time: RESET or \overline{PE}	5	80	-	ns
	10	40	-	
	15	30	-	
Pulse Width: RESET	5	480	-	ns
	10	300	-	
	15	260	-	
\overline{PE}	5	240	-	ns
	10	170	-	
	15	140	-	
CLOCK	5	180	-	ns
	10	90	-	
	15	60	-	
Clock Input Frequency	5	-	2	MHz
	10	DC	4	
	15	-	5.5	
Clock Rise & Fall Time	5	-	15	μs
	10	-	15	
	15	-	5	

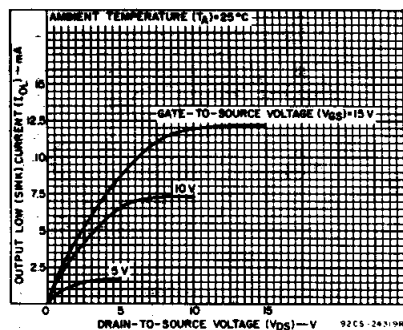

Fig. 7 - Minimum output low (sink) current characteristics.

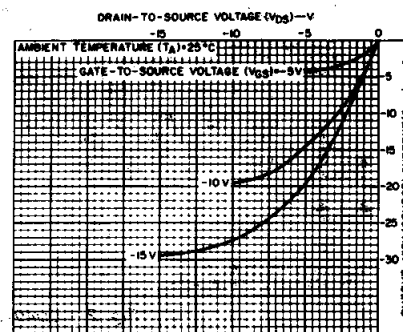

Fig. 8 - Typical output high (source) current characteristics.

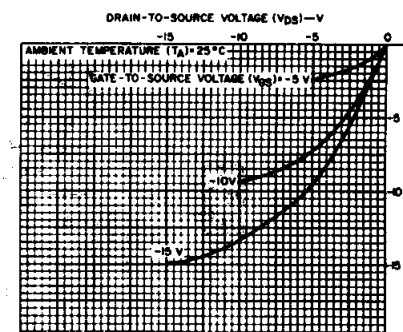

Fig. 9 - Minimum output high (source) current characteristics.

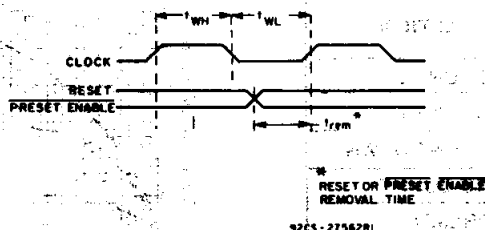

Fig. 10 - Timing diagram defining t_{rem}

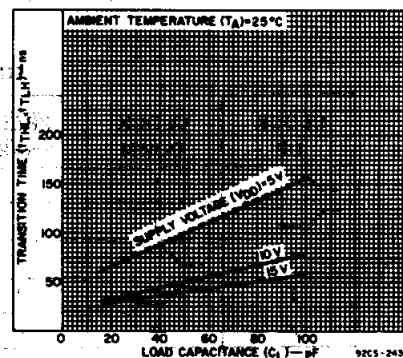

Fig. 11 - Typical transition time as a function of load capacitance.

CD40192B, CD40193B Types

STATIC ELECTRICAL CHARACTERISTICS

CHARACTER- ISTIC	CONDITIONS			LIMITS AT INDICATED TEMPERATURES (°C)							UNITS
	V _O (V)	V _{IN} (V)	V _{DD} (V)	-55			+25			Max.	
				-55	-40	+85	+125	Min.	Typ.		
Quiescent Device Current, I _{DD} Max.	-	0,5	5	5	5	150	150	-	0.04	5	μA
	-	0,10	10	10	10	300	300	-	0.04	10	
	-	0,15	15	20	20	600	600	-	0.04	20	
	-	0,20	20	100	100	3000	3000	-	0.08	100	
Output Low (Sink) Current I _{OL} Min.	0.4	0,5	5	0.64	0.61	0.42	0.36	0.51	1	-	mA
	0.5	0,10	10	1.6	1.5	1.1	0.9	1.3	2.6	-	
	1.5	0,15	15	4.2	4	2.8	2.4	3.4	6.8	-	
Output High (Source) Current, I _{OH} Min.	4.6	0,5	5	-0.64	-0.61	-0.42	-0.36	-0.51	-1	-	mA
	2.5	0,5	5	-2	-1.8	-1.3	-1.15	-1.6	-3.2	-	
	9.5	0,10	10	-1.6	-1.5	-1.1	-0.9	-1.3	-2.6	-	
	13.5	0,15	15	-4.2	-4	-2.8	-2.4	-3.4	-6.8	-	
Output Voltage: Low-Level, V _{OL} Max.	-	0,5	5	0.05			-	0	0.05	-	V
	-	0,10	10	0.05			-	0	0.05	-	
	-	0,15	15	0.05			-	0	0.05	-	
Output Voltage: High-Level, V _{OH} Min.	-	0,5	5	4.95			4.95	5	-	-	V
	-	0,10	10	9.95			9.95	10	-	-	
	-	0,15	15	14.95			14.95	15	-	-	
Input Low Voltage, V _{IL} Max.	0.5, 4.5	-	5	1.5			-	-	1.5	-	V
	1, 9	-	10	3			-	-	3	-	
	1.5, 13.5	-	15	4			-	-	4	-	
Input High Voltage, V _{IH} Min.	0.5, 4.5	-	5	3.5			3.5	-	-	-	V
	1, 9	-	10	7			7	-	-	-	
	1.5, 13.5	-	15	11			11	-	-	-	
Input Current I _{IN} Max.	-	0,18	18	±0.1	±0.1	±1	±1	-	±10 ⁻⁵	±0.1	μA

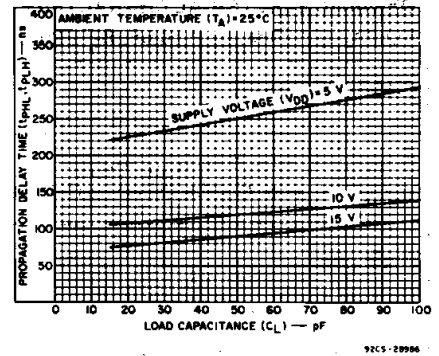

Fig. 12 - Typical propagation delay time as a function of load capacitance.

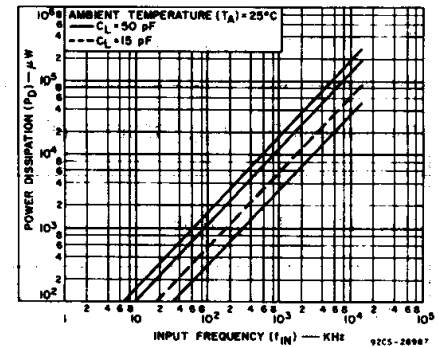
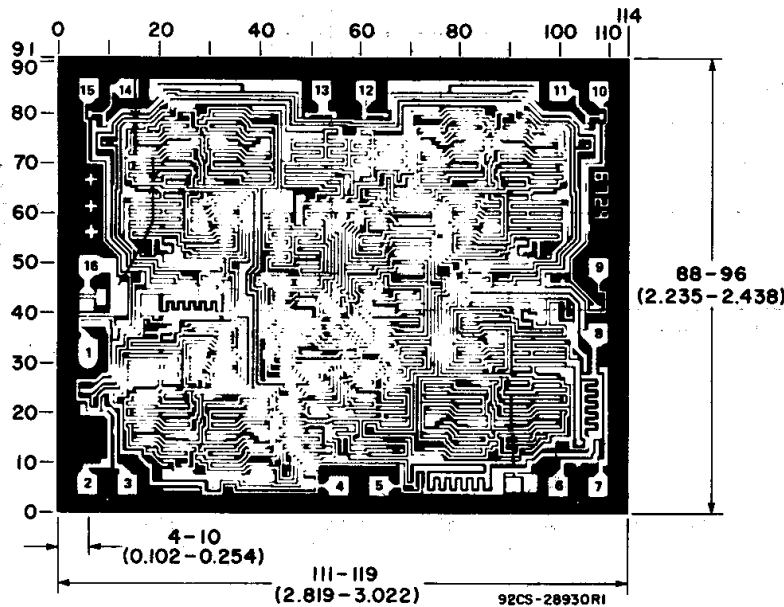

Fig. 13 - Dynamic power dissipation.



Dimensions and pad layout for the CD40192BH (dimensions and pad layout for the CD40193BH are identical).

Dimensions in parentheses are in millimeters and are derived from the basic inch dimensions as indicated. Grid graduations are in mils (10⁻³ inch).

3
COMMERCIAL CMOS
HIGH VOLTAGE ICs

CD40192B, CD40193B Types

DYNAMIC ELECTRICAL CHARACTERISTICS at $T_A = 25^\circ\text{C}$

Input $t_r, t_f = 20 \text{ ns}$, $C_L = 50 \text{ pF}$, $R_L = 200 \text{ k}\Omega$

CHARACTERISTIC	V _{DD} (V)	LIMITS			UNITS
		Min.	Typ.	Max.	
Propagation Delay Time t_{PHL}, t_{PLH} : CLOCK UP or CLOCK DOWN to Q, RESET to Q	5	—	250	500	ns
	10	—	120	240	
	15	—	90	180	
$\overline{\text{PE}}$ to Q	5	—	200	400	ns
	10	—	100	200	
	15	—	70	140	
CLOCK UP to $\overline{\text{CARRY}}$, CLOCK DOWN to $\overline{\text{BORROW}}$	5	—	160	320	ns
	10	—	80	160	
	15	—	60	120	
$\overline{\text{RESET}}$ or $\overline{\text{PE}}$ to $\overline{\text{BORROW}}$ or $\overline{\text{CARRY}}$	5	—	300	600	ns
	10	—	150	300	
	15	—	110	220	
Transition Time, t_{THL}, t_{TLH}	5	—	100	200	ns
	10	—	50	100	
	15	—	40	80	
Min. Removal Time, t_{rem} * RESET or $\overline{\text{PE}}$	5	—	40	80	ns
	10	—	20	40	
	15	—	15	30	
Min. Pulse Width, t_w RESET	5	—	240	480	ns
	10	—	150	300	
	15	—	130	260	
$\overline{\text{PE}}$	5	—	120	240	ns
	10	—	85	170	
	15	—	70	140	
CLOCK	5	—	90	180	ns
	10	—	45	90	
	15	—	30	60	
Max. Clock Input Frequency, f_{CL}	5	2	4	—	MHz
	10	4	8	—	
	15	5.5	11	—	
Clock Rise & Fall Time, t_r, t_f	5	—	—	15	μs
	10	—	—	15	
	15	—	—	5	
Input Capacitance, C_{IN} : RESET	—	—	10	15	pF
	All Other Inputs	—	5	7.5	

* The time required for RESET or PRESET ENABLE control to be removed before clocking (see timing diagram, Fig. 10).

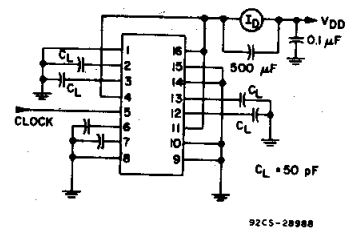

Fig. 14 — Dynamic power dissipation test circuit.

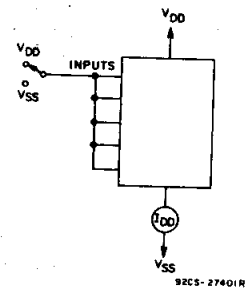

Fig. 15 — Quiescent device current test circuit.

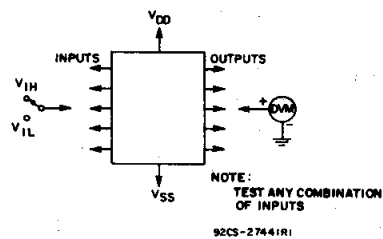

Fig. 16 — Input voltage test circuit.

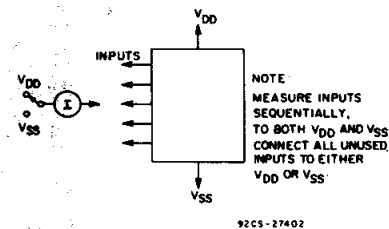

Fig. 17 — Input current test circuit.

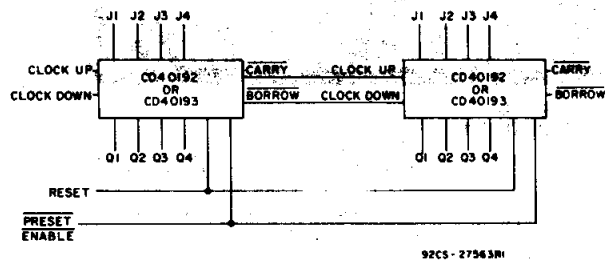

Fig. 18 — Cascaded counter packages.

PACKAGING INFORMATION

Orderable Device	Status ⁽¹⁾	Package Type	Package Drawing	Pins	Package Qty	Eco Plan ⁽²⁾	Lead/Ball Finish	MSL Peak Temp ⁽³⁾
CD40192BE	ACTIVE	PDIP	N	16	25	Pb-Free (RoHS)	CU NIPDAU	Level-NC-NC-NC
CD40192BF	ACTIVE	CDIP	J	16	1	None	Call TI	Level-NC-NC-NC
CD40192BF3A	ACTIVE	CDIP	J	16	1	None	Call TI	Level-NC-NC-NC
CD40192BNSR	ACTIVE	SO	NS	16	2000	Pb-Free (RoHS)	CU NIPDAU	Level-2-260C-1 YEAR/ Level-1-235C-UNLIM
CD40192BPW	ACTIVE	TSSOP	PW	16	90	Pb-Free (RoHS)	CU NIPDAU	Level-1-250C-UNLIM
CD40192BPWR	ACTIVE	TSSOP	PW	16	2000	Pb-Free (RoHS)	CU NIPDAU	Level-1-250C-UNLIM
CD40193BE	ACTIVE	PDIP	N	16	25	Pb-Free (RoHS)	CU NIPDAU	Level-NC-NC-NC
CD40193BF3A	ACTIVE	CDIP	J	16	1	None	Call TI	Level-NC-NC-NC
CD40193BNSR	ACTIVE	SO	NS	16	2000	Pb-Free (RoHS)	CU NIPDAU	Level-2-260C-1 YEAR/ Level-1-235C-UNLIM
CD40193BPW	ACTIVE	TSSOP	PW	16	90	Pb-Free (RoHS)	CU NIPDAU	Level-1-250C-UNLIM
CD40193BPWR	ACTIVE	TSSOP	PW	16	2000	Pb-Free (RoHS)	CU NIPDAU	Level-1-250C-UNLIM

⁽¹⁾ The marketing status values are defined as follows:

ACTIVE: Product device recommended for new designs.

LIFEBUY: TI has announced that the device will be discontinued, and a lifetime-buy period is in effect.

NRND: Not recommended for new designs. Device is in production to support existing customers, but TI does not recommend using this part in a new design.

PREVIEW: Device has been announced but is not in production. Samples may or may not be available.

OBSELETE: TI has discontinued the production of the device.

⁽²⁾ Eco Plan - May not be currently available - please check <http://www.ti.com/productcontent> for the latest availability information and additional product content details.

None: Not yet available Lead (Pb-Free).

Pb-Free (RoHS): TI's terms "Lead-Free" or "Pb-Free" mean semiconductor products that are compatible with the current RoHS requirements for all 6 substances, including the requirement that lead not exceed 0.1% by weight in homogeneous materials. Where designed to be soldered at high temperatures, TI Pb-Free products are suitable for use in specified lead-free processes.

Green (RoHS & no Sb/Br): TI defines "Green" to mean "Pb-Free" and in addition, uses package materials that do not contain halogens, including bromine (Br) or antimony (Sb) above 0.1% of total product weight.

⁽³⁾ MSL, Peak Temp. -- The Moisture Sensitivity Level rating according to the JEDEC industry standard classifications, and peak solder temperature.

Important Information and Disclaimer: The information provided on this page represents TI's knowledge and belief as of the date that it is provided. TI bases its knowledge and belief on information provided by third parties, and makes no representation or warranty as to the accuracy of such information. Efforts are underway to better integrate information from third parties. TI has taken and continues to take reasonable steps to provide representative and accurate information but may not have conducted destructive testing or chemical analysis on incoming materials and chemicals. TI and TI suppliers consider certain information to be proprietary, and thus CAS numbers and other limited information may not be available for release.

In no event shall TI's liability arising out of such information exceed the total purchase price of the TI part(s) at issue in this document sold by TI to Customer on an annual basis.

J (R-GDIP-T**)

14 LEADS SHOWN

CERAMIC DUAL IN-LINE PACKAGE



DIM \ PINS **	14	16	18	20
A	0.300 (7,62) BSC	0.300 (7,62) BSC	0.300 (7,62) BSC	0.300 (7,62) BSC
B MAX	0.785 (19,94)	.840 (21,34)	0.960 (24,38)	1.060 (26,92)
B MIN	—	—	—	—
C MAX	0.300 (7,62)	0.300 (7,62)	0.310 (7,87)	0.300 (7,62)
C MIN	0.245 (6,22)	0.245 (6,22)	0.220 (5,59)	0.245 (6,22)



4040083/F 03/03

- NOTES:
- A. All linear dimensions are in inches (millimeters).
 - B. This drawing is subject to change without notice.
 - C. This package is hermetically sealed with a ceramic lid using glass frit.
 - D. Index point is provided on cap for terminal identification only on press ceramic glass frit seal only.
 - E. Falls within MIL STD 1835 GDIP1-T14, GDIP1-T16, GDIP1-T18 and GDIP1-T20.

N (R-PDIP-T**)

PLASTIC DUAL-IN-LINE PACKAGE

16 PINS SHOWN



4040049/E 12/2002

- NOTES:
- A. All linear dimensions are in inches (millimeters).
 - B. This drawing is subject to change without notice.
 - $\triangle C$ Falls within JEDEC MS-001, except 18 and 20 pin minimum body length (Dim A).
 - $\triangle D$ The 20 pin end lead shoulder width is a vendor option, either half or full width.

MECHANICAL DATA

NS (R-PDSO-G**)

PLASTIC SMALL-OUTLINE PACKAGE

14-PINS SHOWN



- NOTES:
- A. All linear dimensions are in millimeters.
 - B. This drawing is subject to change without notice.
 - C. Body dimensions do not include mold flash or protrusion, not to exceed 0,15.

PW (R-PDSO-G**)

PLASTIC SMALL-OUTLINE PACKAGE

14 PINS SHOWN

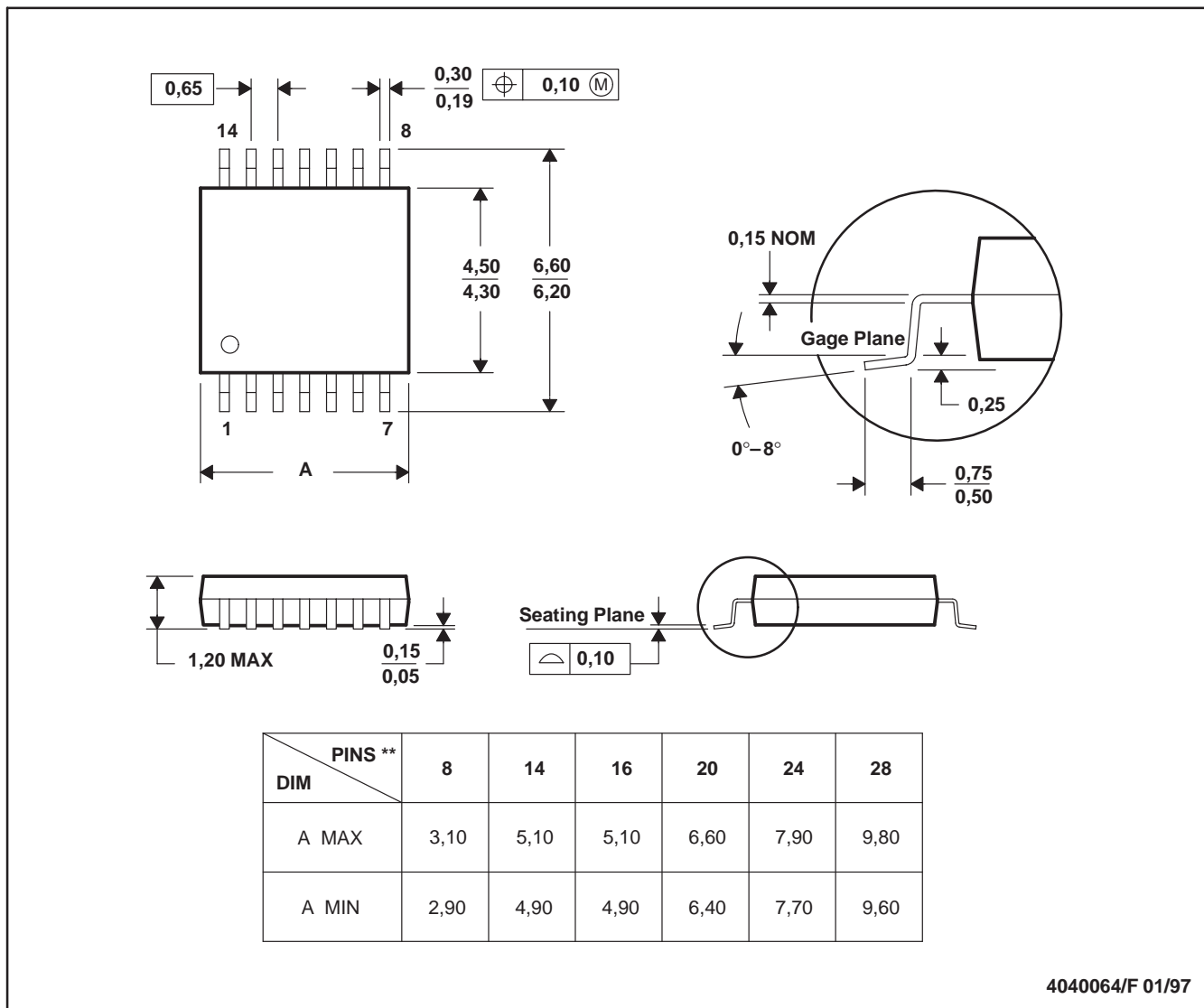

4040064/F 01/97

- NOTES: A. All linear dimensions are in millimeters.
 B. This drawing is subject to change without notice.
 C. Body dimensions do not include mold flash or protrusion not to exceed 0,15.
 D. Falls within JEDEC MO-153

IMPORTANT NOTICE

Texas Instruments Incorporated and its subsidiaries (TI) reserve the right to make corrections, modifications, enhancements, improvements, and other changes to its products and services at any time and to discontinue any product or service without notice. Customers should obtain the latest relevant information before placing orders and should verify that such information is current and complete. All products are sold subject to TI's terms and conditions of sale supplied at the time of order acknowledgment.

TI warrants performance of its hardware products to the specifications applicable at the time of sale in accordance with TI's standard warranty. Testing and other quality control techniques are used to the extent TI deems necessary to support this warranty. Except where mandated by government requirements, testing of all parameters of each product is not necessarily performed.

TI assumes no liability for applications assistance or customer product design. Customers are responsible for their products and applications using TI components. To minimize the risks associated with customer products and applications, customers should provide adequate design and operating safeguards.

TI does not warrant or represent that any license, either express or implied, is granted under any TI patent right, copyright, mask work right, or other TI intellectual property right relating to any combination, machine, or process in which TI products or services are used. Information published by TI regarding third-party products or services does not constitute a license from TI to use such products or services or a warranty or endorsement thereof. Use of such information may require a license from a third party under the patents or other intellectual property of the third party, or a license from TI under the patents or other intellectual property of TI.

Reproduction of information in TI data books or data sheets is permissible only if reproduction is without alteration and is accompanied by all associated warranties, conditions, limitations, and notices. Reproduction of this information with alteration is an unfair and deceptive business practice. TI is not responsible or liable for such altered documentation.

Resale of TI products or services with statements different from or beyond the parameters stated by TI for that product or service voids all express and any implied warranties for the associated TI product or service and is an unfair and deceptive business practice. TI is not responsible or liable for any such statements.

Following are URLs where you can obtain information on other Texas Instruments products and application solutions:

Products		Applications	
Amplifiers	amplifier.ti.com	Audio	www.ti.com/audio
Data Converters	dataconverter.ti.com	Automotive	www.ti.com/automotive
DSP	dsp.ti.com	Broadband	www.ti.com/broadband
Interface	interface.ti.com	Digital Control	www.ti.com/digitalcontrol
Logic	logic.ti.com	Military	www.ti.com/military
Power Mgmt	power.ti.com	Optical Networking	www.ti.com/opticalnetwork
Microcontrollers	microcontroller.ti.com	Security	www.ti.com/security
		Telephony	www.ti.com/telephony
		Video & Imaging	www.ti.com/video
		Wireless	www.ti.com/wireless

Mailing Address: Texas Instruments
Post Office Box 655303 Dallas, Texas 75265