

## MM74HCT05 Hex Inverter (Open Drain)

### General Description

The MM74HCT05 is a logic function fabricated by using advanced silicon-gate CMOS technology, which provides the inherent benefits of CMOS—low quiescent power and wide power supply range. The device is also input and output characteristic and pinout compatible with standard DM74LS logic families. The MM74HCT05 open drain Hex Inverter requires the addition of an external resistor to perform a wire-NOR function.

All inputs are protected from static discharge damage by internal diodes to  $V_{CC}$  and ground.

MM74HCT devices are intended to interface between TTL and NMOS components and standard CMOS devices.

These parts are also plug-in replacements for LS-TTL devices and can be used to reduce power consumption in existing designs.

### Features

- Open drain for wire-NOR function
- LS-TTL pinout and threshold compatible
- Fanout of 10 LS-TTL loads
- Typical propagation delays:
  - $t_{PLH}$  (with 1 k $\Omega$  resistor) 10 ns
  - $t_{PHL}$  (with 1 k $\Omega$  resistor) 8 ns

### Ordering Code:

Order Number	Package Number	Package Description
MM74HCT05M	M14A	14-Lead Small Outline Integrated Circuit (SOIC), JEDEC MS-120, 0.150" Narrow
MM74HCT05SJ	M14D	14-Lead Small Outline Package (SOP), EIAJ TYPE II, 5.3mm Wide
MM74HCT05MTC	MTC14	14-Lead Thin Shrink Small Outline Package (TSSOP), JEDEC MO-153, 4.4mm Wide
MM74HCT05N	N14A	14-Lead Plastic Dual-In-Line Package (PDIP), JEDEC MS-001, 0.300" Wide

Devices also available in Tape and Reel. Specify by appending the suffix letter "X" to the ordering code.

### Connection Diagram

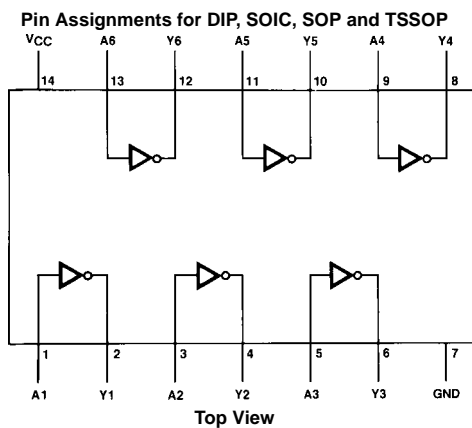

### Logic Diagram

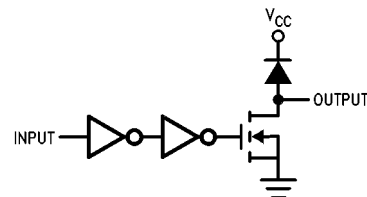

### Typical Application

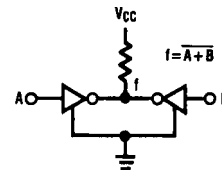

**Absolute Maximum Ratings** (Note 1)

(Note 2)

Supply Voltage ( $V_{CC}$ )	-0.5 to +7.0V
DC Input Voltage ( $V_{IN}$ )	-1.5 to $V_{CC} + 1.5V$
DC Output Voltage ( $V_{OUT}$ )	-0.5 to $V_{CC} + 0.5V$
Clamp Diode Current ( $I_{IK}, I_{OK}$ )	$\pm 20$ mA
DC Output Current, per pin ( $I_{OUT}$ )	$\pm 25$ mA
DC $V_{CC}$ or GND Current, per pin ( $I_{CC}$ )	$\pm 50$ mA
Storage Temperature Range ( $T_{STG}$ )	-65°C to +150°C
Power Dissipation ( $P_D$ )	
(Note 3)	600 mW
S.O. Package only	500 mW
Lead Temperature ( $T_L$ )	
(Soldering 10 seconds)	260°C

**Recommended Operating Conditions**

	Min	Max	Units
Supply Voltage ( $V_{CC}$ )	4.5	5.5	V
DC Input or Output Voltage ( $V_{IN}, V_{OUT}$ )	0	$V_{CC}$	V
Operating Temperature Range ( $T_A$ )	-40	+85	°C
Input Rise or Fall Times ( $t_r, t_f$ )		500	ns

**Note 1:** Absolute Maximum Ratings are those values beyond which damage to the device may occur.**Note 2:** Unless otherwise specified all voltages are referenced to ground.**Note 3:** Power Dissipation temperature derating — plastic "N" package: -12 mW/°C from 65°C to 85°C.**DC Electrical Characteristics** $(V_{CC} = 5V \pm 10\%$ , unless otherwise specified)

Symbol	Parameter	Conditions	$T_A = 25^\circ\text{C}$		$T_A = -40$ to $85^\circ\text{C}$	Units	
			Typ	Guaranteed Limits			
$V_{IH}$	Minimum HIGH Level Input Voltage			2.0	2.0	V	
$V_{IL}$	Maximum LOW Level Input Voltage			0.8	0.8	V	
$V_{OL}$	Maximum LOW Level Voltage	$V_{IN} = V_{IH}$		0	0.1	0.1	V
		$ I_{OUT}  = 20 \mu\text{A}$		0.2	0.26	0.33	V
		$ I_{OUT}  = 4.0 \text{ mA}, V_{CC} = 4.5V$ $ I_{OUT}  = 4.8 \text{ mA}, V_{CC} = 5.5V$		0.2	0.26	0.33	V
$I_{IN}$	Maximum Input Current	$V_{IN} = V_{CC}$ or GND, $V_{IH}$ or $V_{IL}$		$\pm 0.1$	$\pm 1.0$	$\mu\text{A}$	
$I_{LKG}$	Maximum HIGH Level Output Leakage Current	$V_{IN} = V_{IH}$ or $V_{IL}, V_{OUT} = V_{CC}$		0.5	5.0	$\mu\text{A}$	
$I_{CC}$	Maximum Quiescent Supply Current	$V_{IN} = V_{CC}$ or GND $I_{OUT} = 0 \mu\text{A}$		2.0	20	$\mu\text{A}$	
		$V_{IN} = 2.4V$ or $0.5V$ (Note 4)		0.3	0.4	mA	

**Note 4:** This is measured per input with all other inputs held at  $V_{CC}$  or ground.

<b>AC Electrical Characteristics</b>						
$V_{CC} = 5V, T_A = 25^\circ C, C_L = 15 \text{ pF}, t_r = t_f = 6 \text{ ns}$ unless otherwise noted.						
Symbol	Parameter	Conditions	Typ	Guaranteed Limit	Units	
$t_{PZL}$	Maximum Propagation Delay	$R_L = 1 \text{ k}\Omega$	8	15	ns	
$t_{PLZ}$	Maximum Propagation Delay	$R_L = 1 \text{ k}\Omega$	9	16	ns	
<b>AC Electrical Characteristics</b>						
$V_{CC} = 5V, \pm 10\%, C_L = 50\text{pF}, t_r = t_f = 6\text{ns}$ unless otherwise specified.						
Symbol	Parameter	Conditions	$T_A = 25^\circ C$		$T_A = -40 \text{ to } 85^\circ C$	Units
			Typ	Guaranteed Limits		
$t_{PZL}$	Maximum Propagation Delay	$R_L = 1 \text{ k}\Omega$	10	22	28	ns
$t_{PLZ}$	Maximum Propagation Delay	$R_L = 1 \text{ k}\Omega$	12	20	25	ns
$t_{THL}$	Maximum Output Fall Time		10	15	19	ns
$C_{PD}$	Power Dissipation Capacitance (Note 5)	(per gate) $R_L = \infty$		20		pF
$C_{IN}$	Maximum Input Capacitance			5	10	pF
<p><b>Note 5:</b> <math>C_{PD}</math> determines the no load dynamic power consumption, <math>P_D = C_{PD} V_{CC}^2 f + I_{CC} V_{CC}</math>, and the no load dynamic current consumption, <math>I_S = C_{PD} V_{CC} f + I_{CC}</math>.</p>						

**Physical Dimensions** inches (millimeters) unless otherwise noted

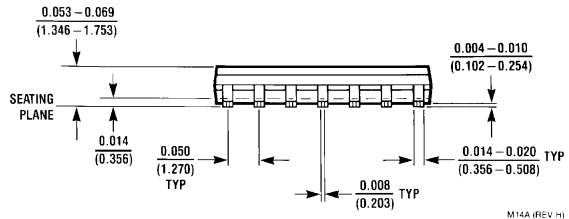
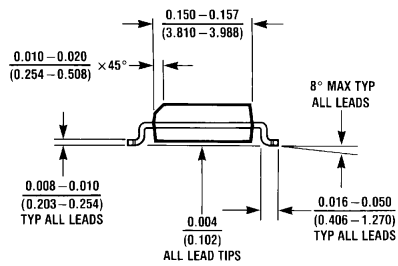
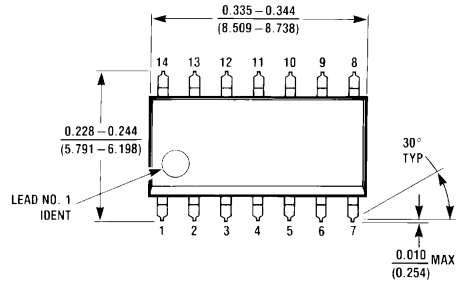

**14-Lead Small Outline Integrated Circuit (SOIC), JEDEC MS-120, 0.150" Narrow  
Package Number M14A**

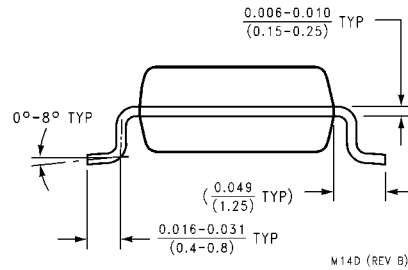
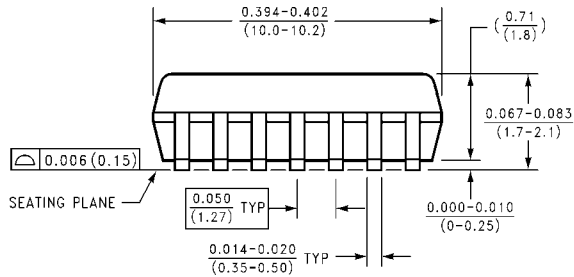
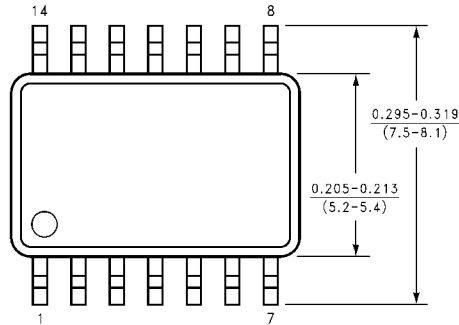

**14-Lead Small Outline Package (SOP), EIAJ TYPE II, 5.3mm Wide  
Package Number M14D**

**Physical Dimensions** inches (millimeters) unless otherwise noted (Continued)

14LD, TSSOP, JEDEC MO-153, 4.4MM WIDE

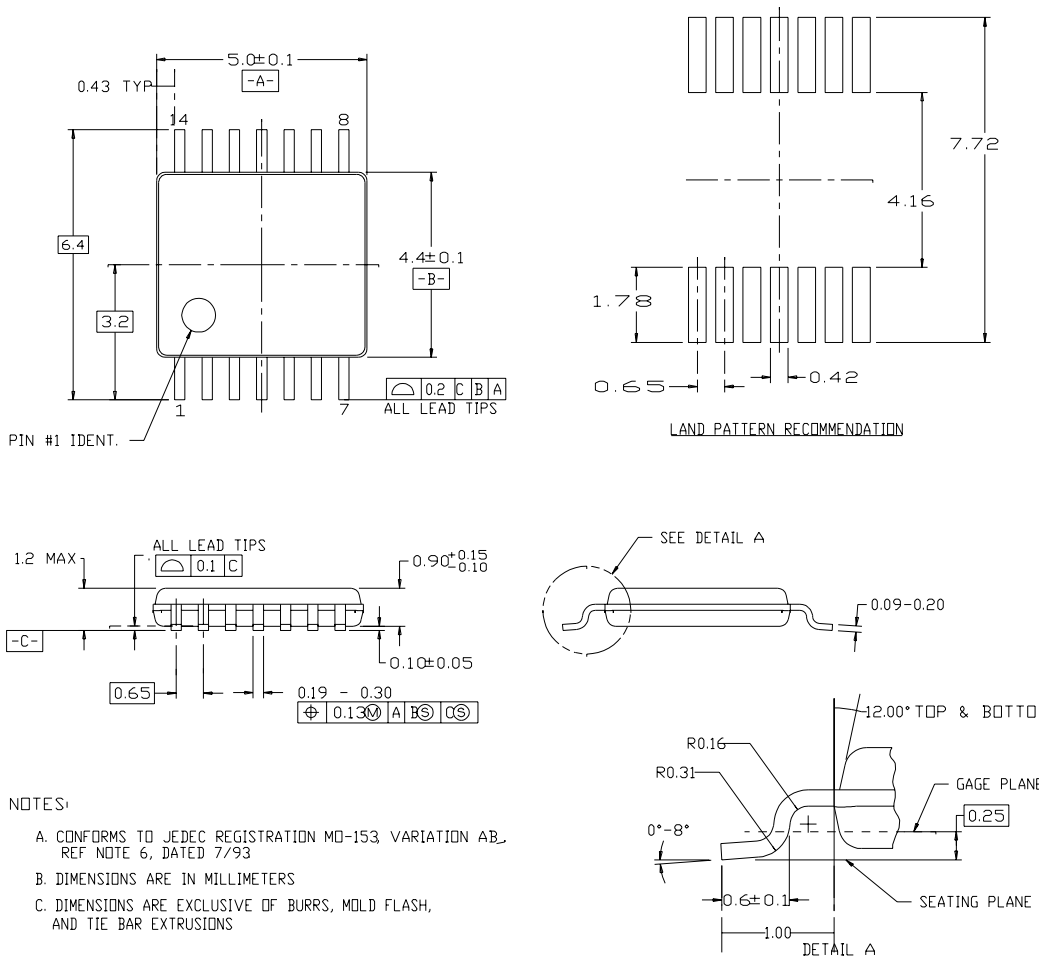

NOTES:

- A. CONFORMS TO JEDEC REGISTRATION MO-153, VARIATION AB, REF NOTE 6, DATED 7/93
- B. DIMENSIONS ARE IN MILLIMETERS
- C. DIMENSIONS ARE EXCLUSIVE OF BURRS, MOLD FLASH, AND TIE BAR EXTRUSIONS

**14-Lead Thin Shrink Small Outline Package (TSSOP), JEDEC MO-153, 4.4mm Wide  
Package Number MTC14**

**Physical Dimensions** inches (millimeters) unless otherwise noted (Continued)

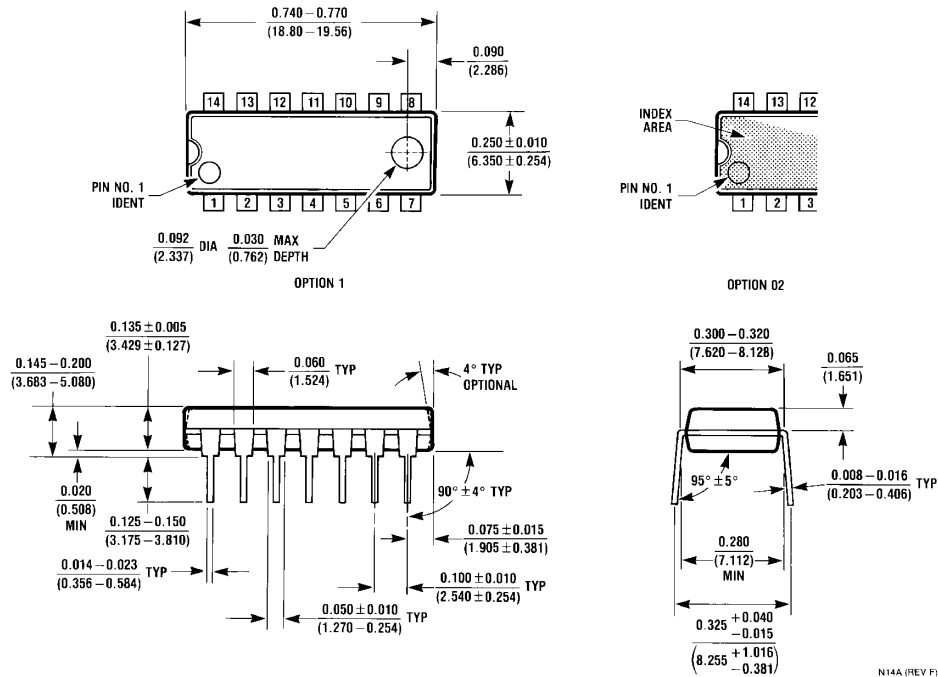

**14-Lead Plastic Dual-In-Line Package (PDIP), JEDEC MS-001, 0.300" Wide Package Number N14A**

**LIFE SUPPORT POLICY**

FAIRCHILD'S PRODUCTS ARE NOT AUTHORIZED FOR USE AS CRITICAL COMPONENTS IN LIFE SUPPORT DEVICES OR SYSTEMS WITHOUT THE EXPRESS WRITTEN APPROVAL OF THE PRESIDENT OF FAIRCHILD SEMICONDUCTOR CORPORATION. As used herein:

1. Life support devices or systems are devices or systems which, (a) are intended for surgical implant into the body, or (b) support or sustain life, and (c) whose failure to perform when properly used in accordance with instructions for use provided in the labeling, can be reasonably expected to result in a significant injury to the user.
2. A critical component in any component of a life support device or system whose failure to perform can be reasonably expected to cause the failure of the life support device or system, or to affect its safety or effectiveness.

[www.fairchildsemi.com](http://www.fairchildsemi.com)