

SHINDENGEN

Switching Power Transistor

HFx Series

2SC4231
(TP2V80HFx)

2A NPN

OUTLINE DIMENSIONS

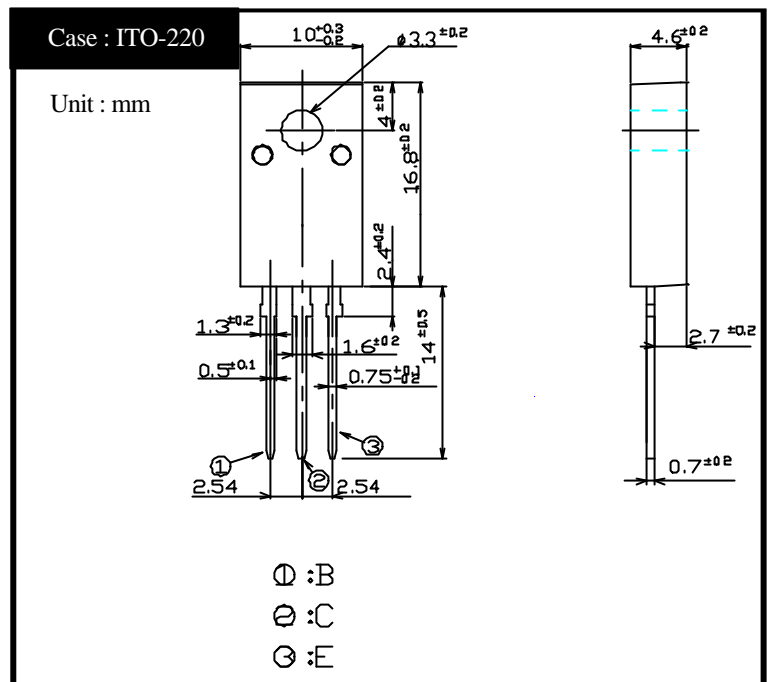

RATINGS

Absolute Maximum Ratings

Item	Symbol	Conditions	Ratings	Unit
Storage Temperature	T_{stg}		-55 ~ 150	
Junction Temperature	T_j		150	
Collector to Base Voltage	V_{CBO}		1200	V
Collector to Emitter Voltage	V_{CEO}		800	V
Emitter to Base Voltage	V_{EBO}		7	V
Collector Current DC	I_C		2	A
Collector Current Peak	I_{CP}		4	
Base Current DC	I_B		1	A
Base Current Peak	I_{BP}		2	
Total Transistor Dissipation	P_T	$T_C = 25$	30	W
Dielectric Strength	V_{dis}	Terminals to case, AC 1 minute	2	kV
Mounting Torque	TOR	(Recommended torque : 0.3N·m)	0.5	N·m

Electrical Characteristics ($T_C=25$)

Item	Symbol	Conditions	Ratings	Unit
Collector to Emitter Sustaining Voltage	$V_{CEO(sus)}$	$I_C = 0.1A$	Min 800	V
Collector Cutoff Current	I_{CBO}	At rated Voltage	Max 0.1	mA
	I_{CEO}		Max 0.1	
Emitter Cutoff Current	I_{EBO}	At rated Voltage	Max 0.1	mA
DC Current Gain	h_{FE}	$V_{CE} = 5V, I_C = 1A$	Min 8	
	h_{FEL}	$V_{CE} = 5V, I_C = 1mA$	Min 7	
Collector to Emitter Saturation Voltage	$V_{CE(sat)}$	$I_C = 1A$	Max 1.0	V
Base to Emitter Saturation Voltage	$V_{BE(sat)}$	$I_B = 0.2A$	Max 1.5	V
Thermal Resistance	θ_{jC}	Junction to case	Max 4.16	/W
Transition Frequency	f_T	$V_{CE} = 10V, I_C = 0.2A$	TYP 8	MHz
Turn on Time	t_{on}	$I_C = 1A$	Max 0.5	μs
Storage Time	t_s	$I_{B1} = 0.2A, I_{B2} = 0.4A$	Max 3.5	
Fall Time	t_f	$R_L = 250 \Omega, V_{BB2} = 4V$	Max 0.3	

2SC4231 $h_{FE} - I_C$

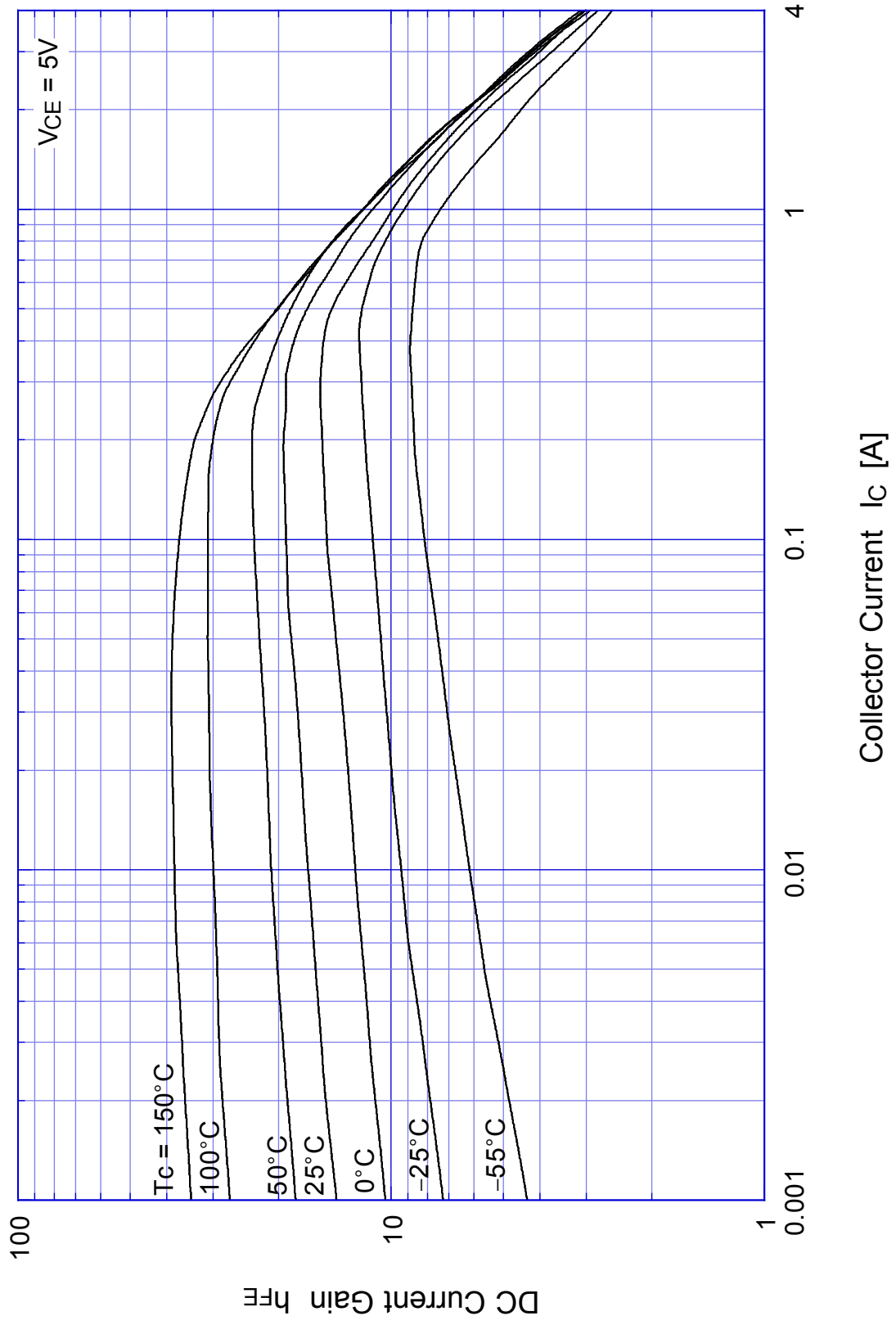

2SC4231 Saturation Voltage

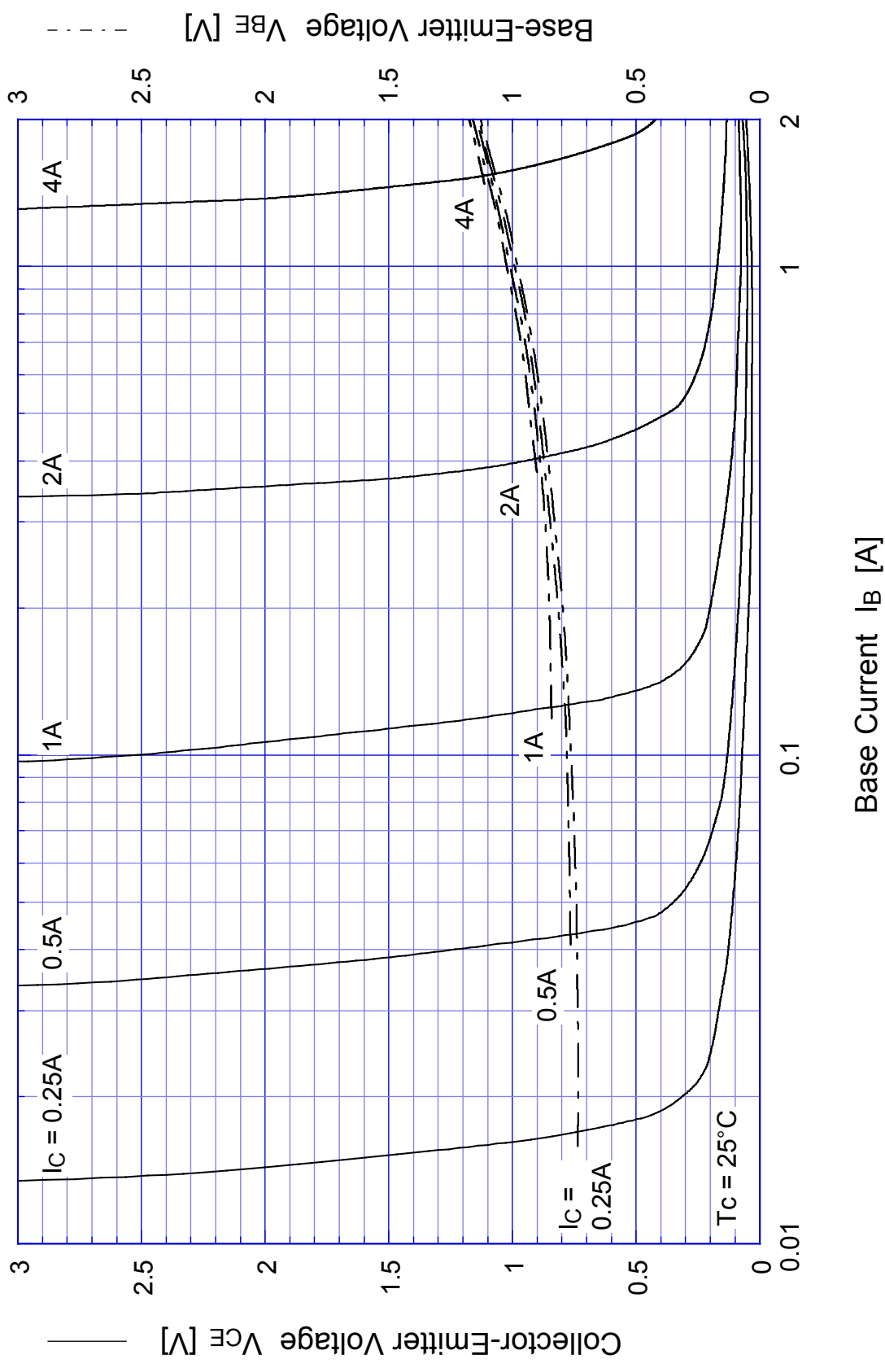

2SC4231

Switching Time - I_C

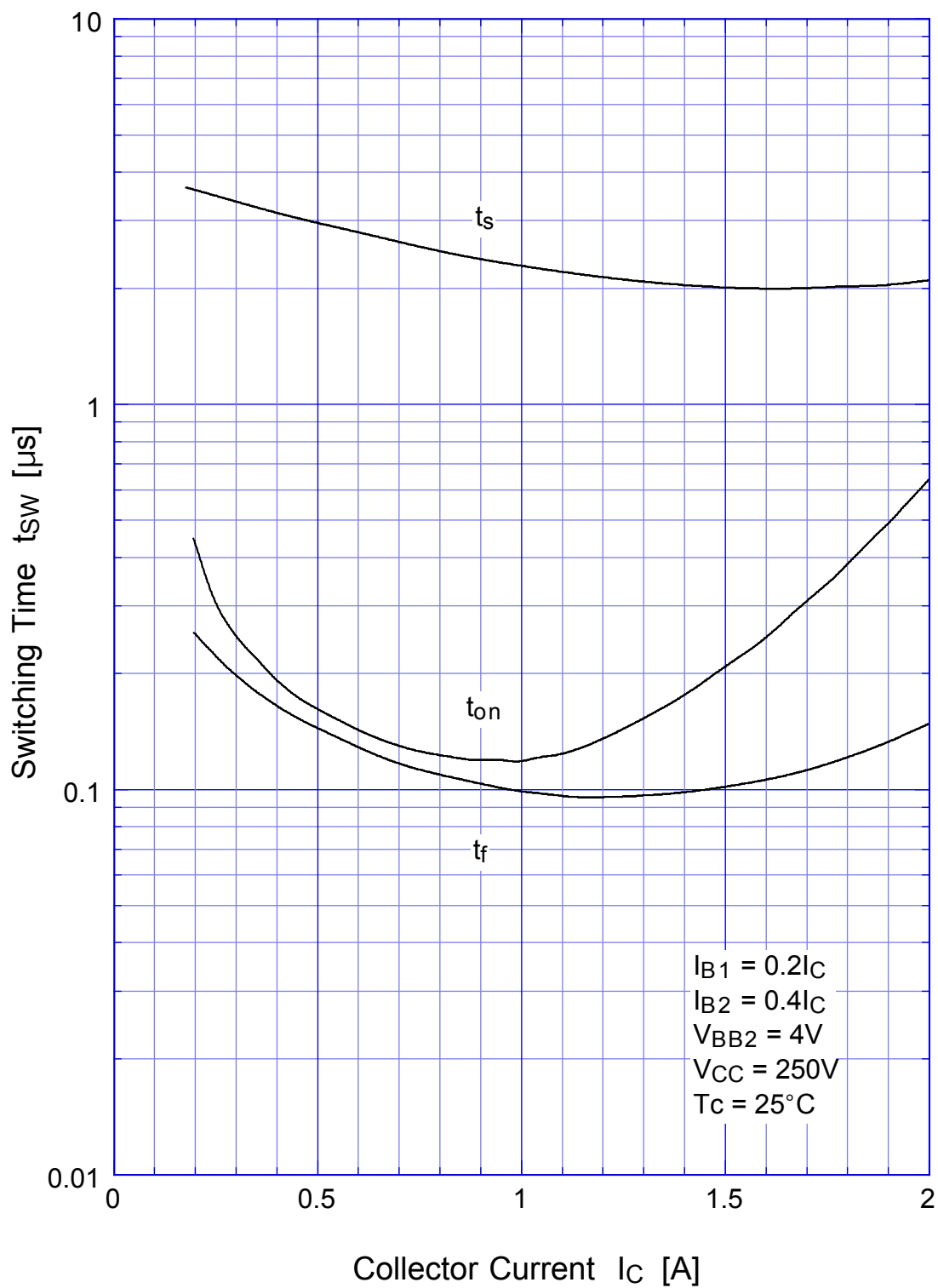

2SC4231 Switching Time - V_{CC}

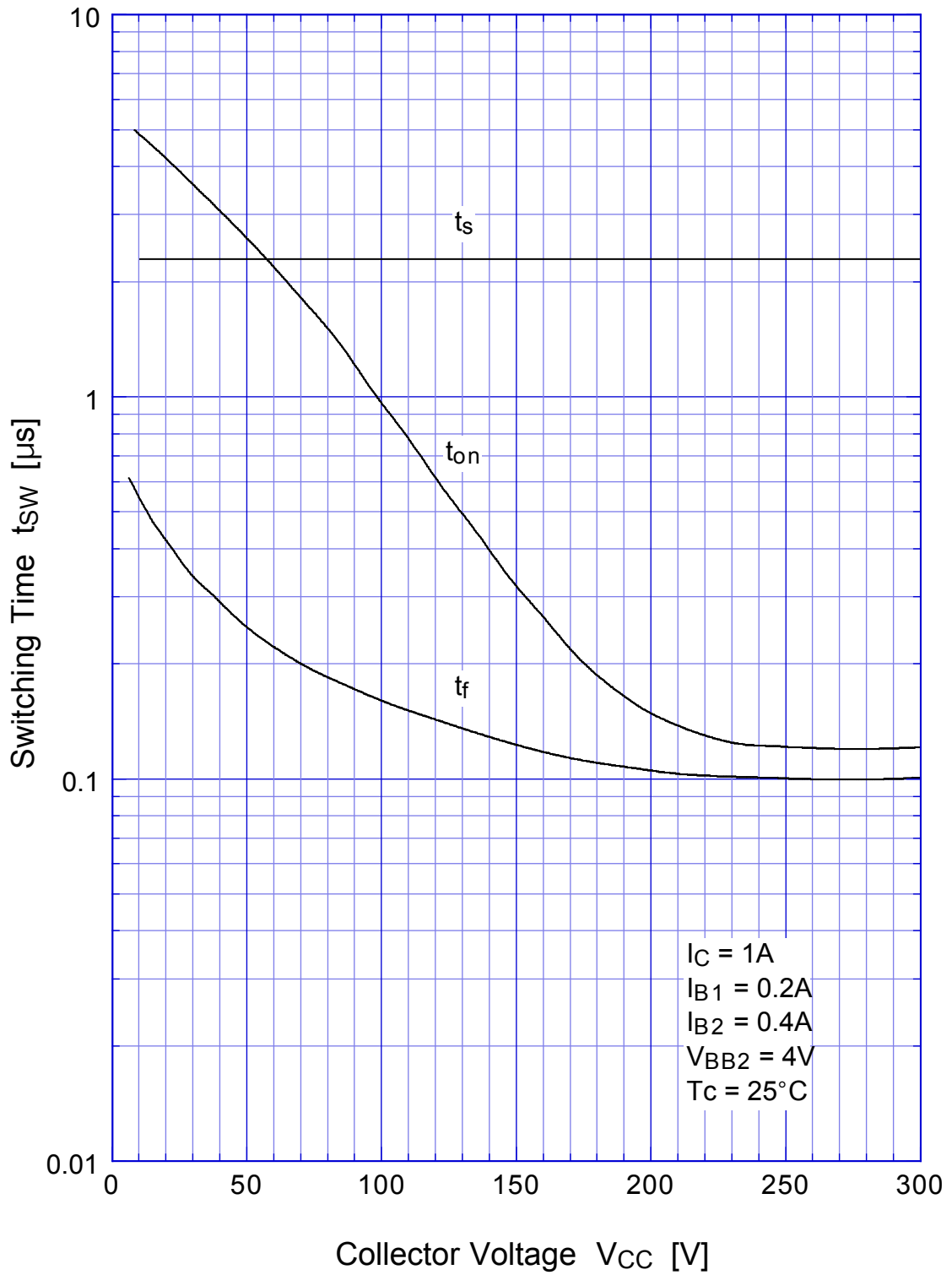

2SC4231

Switching Time - Tc

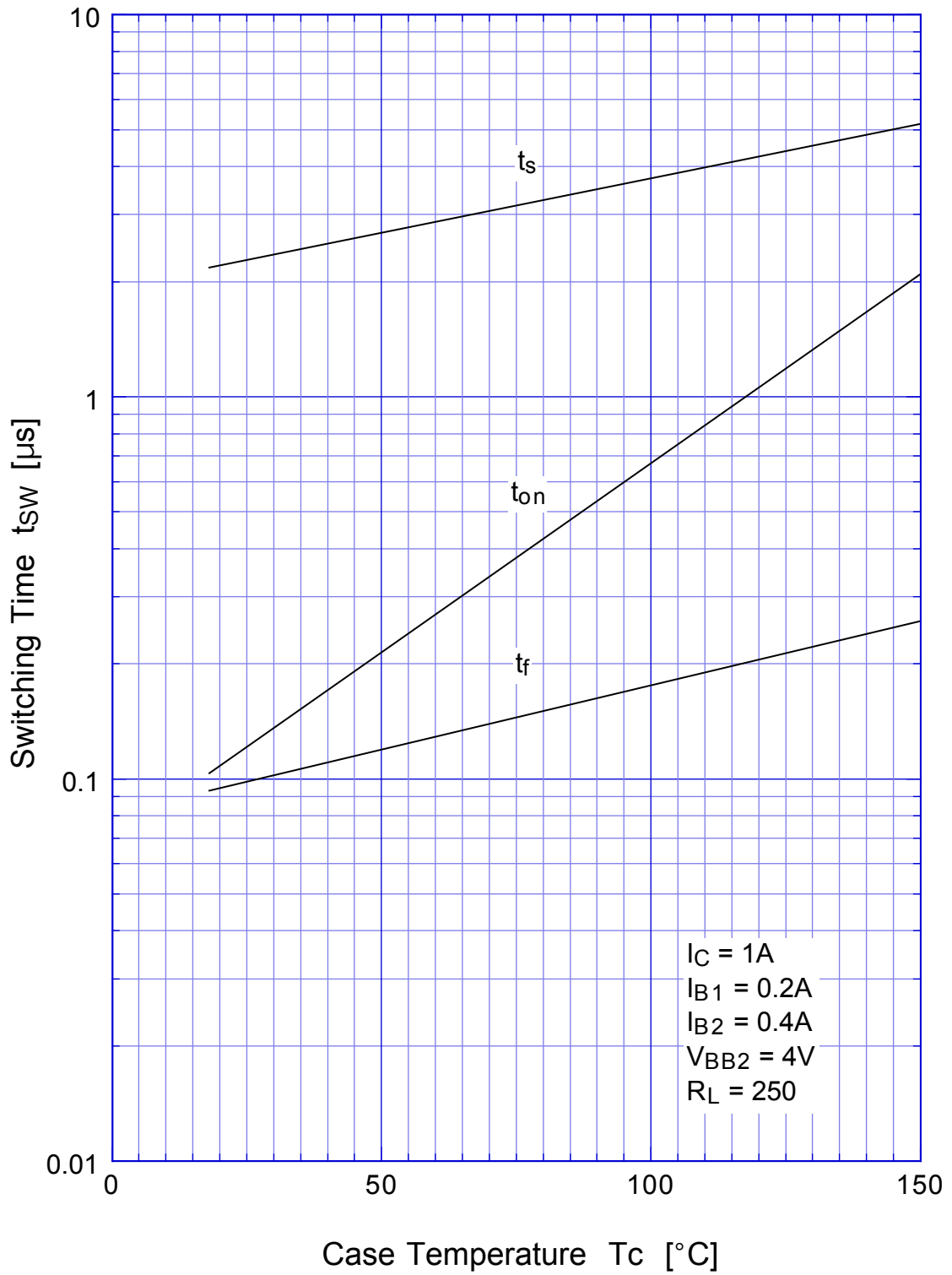

2SC4231 L-Load Switching Time - I_C

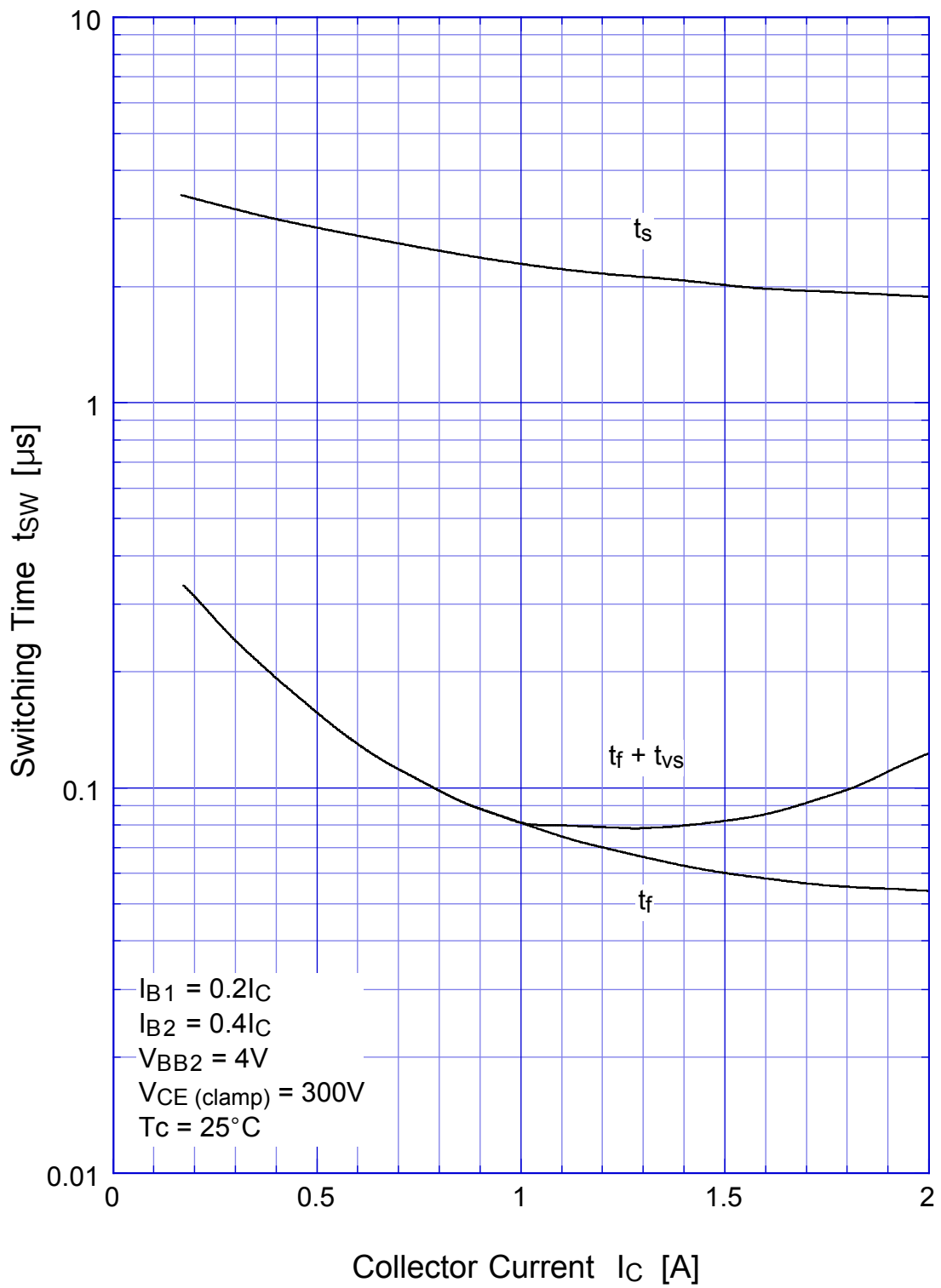

2SC4231 L-Load Switching Time - I_C (At High Temperature)

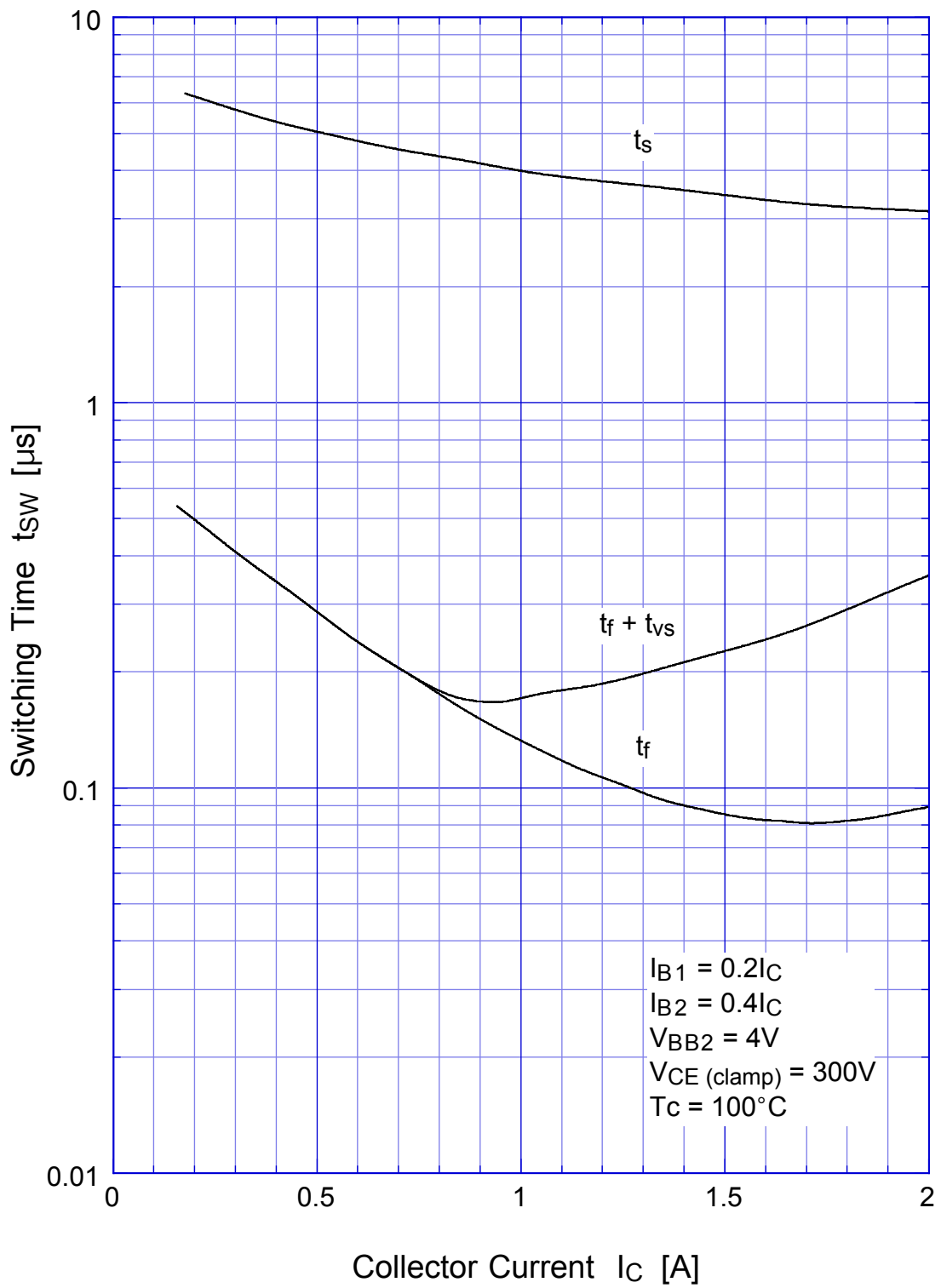

2SC4231 Transient Thermal Impedance

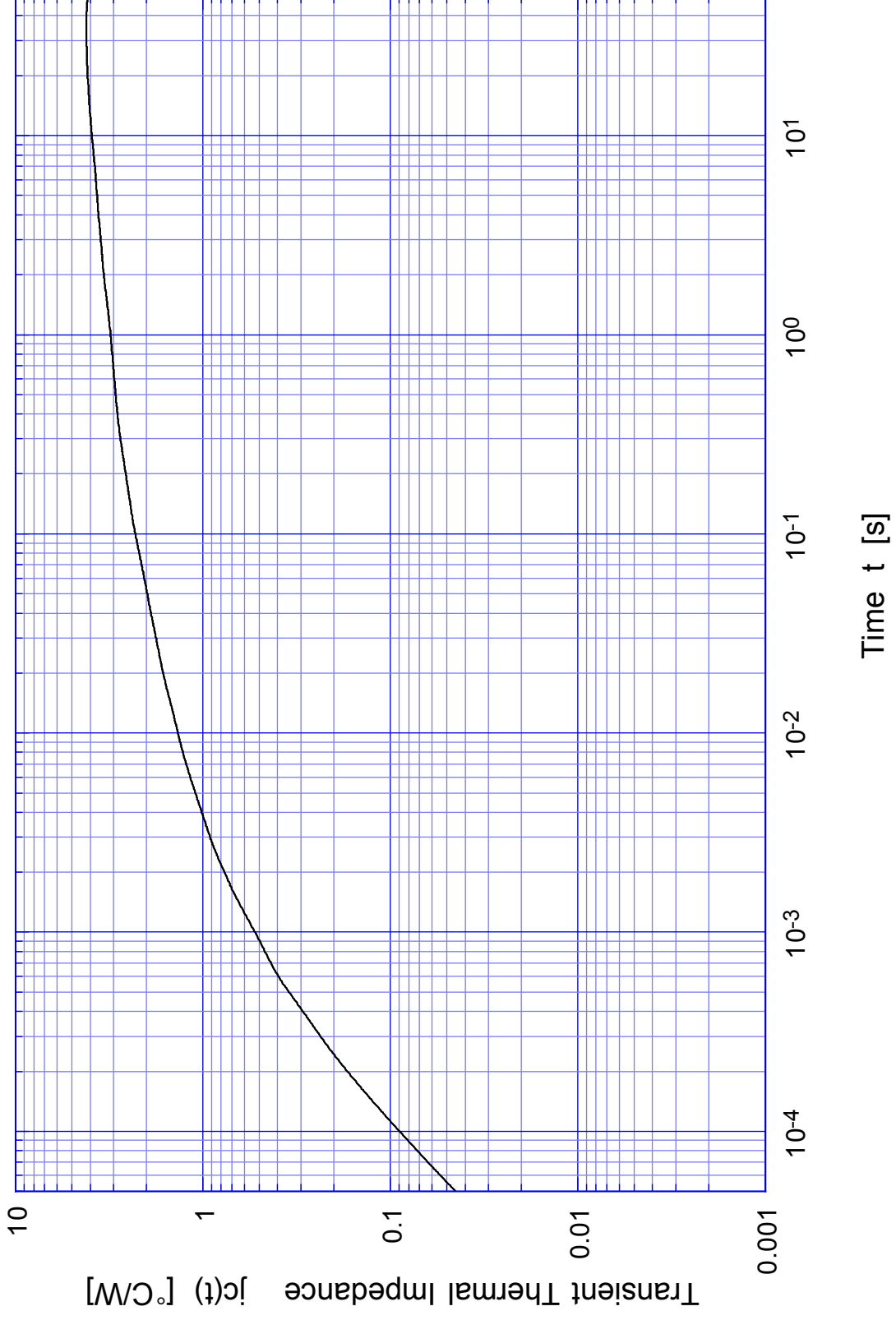

2SC4231

Forward Bias SOA

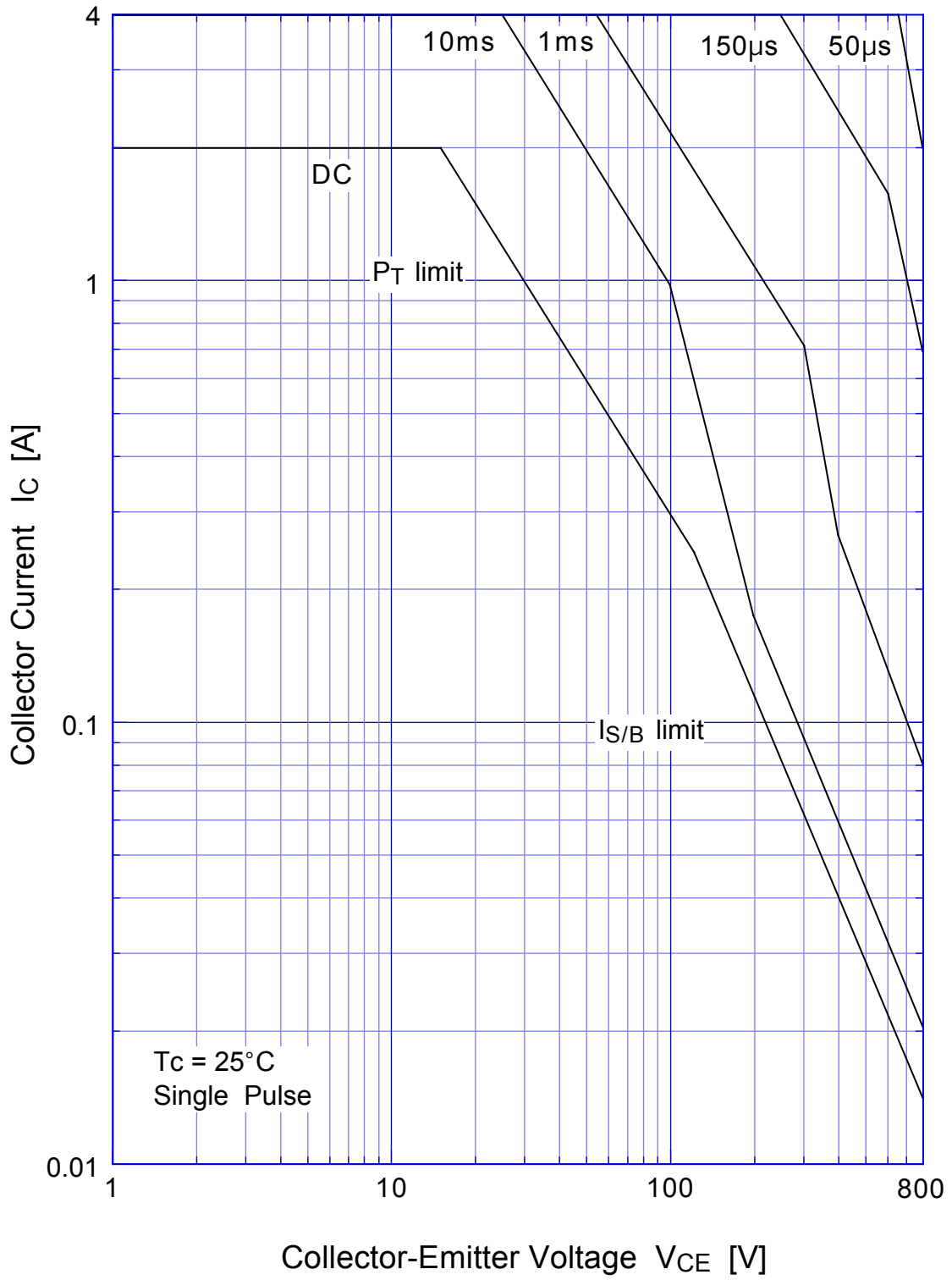

2SC4231 Collector Current Derating



2SC4231

Reverse Bias SOA

