

*RoHS COMPLIANT

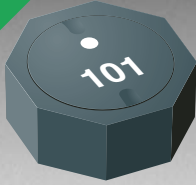

BOURNS®

Features

- Available in E6 series
- Unit height of 4.3 mm
- Current up to 5.4 A
- Lead free
- RoHS compliant*

Applications

- Input/output of DC/DC converters
- Power supplies for:
 - Portable communication equipment
 - Camcorders
 - LCD TVs
 - Car radios

SRU8043 Series - Shielded SMD Power Inductors

Electrical Specifications

Bourns Part No.	Inductance 100 KHz		Q Ref.	Test Frequency (MHz)	SRF Min. (MHz)	RDC (mΩ)	I rms Max. (A)	I sat Typ. (A)
	(μH)	Tol. %						
SRU8043-2R2Y	2.2	± 30	15	7.96	65.0	11.2	5.40	5.20
SRU8043-3R9Y	3.9	± 30	15	7.96	42.0	14.6	4.80	4.00
SRU8043-4R7Y	4.7	± 30	13	7.96	36.0	17.0	4.60	3.60
SRU8043-6R8Y	6.8	± 30	12	7.96	30.0	22.4	3.80	3.10
SRU8043-100Y	10.0	± 30	27	2.52	20.0	30.0	3.50	2.70
SRU8043-150Y	15.0	± 30	26	2.52	15.0	46.0	2.70	2.00
SRU8043-220Y	22.0	± 30	24	2.52	12.0	72.5	2.20	1.70
SRU8043-330Y	33.0	± 30	21	2.52	11.0	100.0	1.70	1.40
SRU8043-470Y	47.0	± 30	21	2.52	9.0	120.0	1.50	1.20
SRU8043-680Y	68.0	± 30	20	2.52	7.0	192.0	1.20	1.00
SRU8043-101Y	100.0	± 30	50	0.796	6.0	287.0	1.00	0.80

General Specifications

Test Voltage.....1 V
 Reflow Soldering ...230 °C, 50 sec. max.
 Operating Temperature -40 °C to +125 °C
 (Temperature rise included)
 Storage Temperature..-40 °C to +125 °C
 Resistance to Soldering Heat
260 °C for 10 sec.

Materials

Core.....Ferrite DR and RI core
 Wire.....Enameled copper
 Base.....LCP E4008
 Terminal.....Ag/Ni/Sn
 Rated Current
Ind. drop 35 % typ. at Isat
 Temperature Rise
40 °C max. at rated I_{rms}
 Packaging.....1000 pcs. per reel

Electrical Schematic

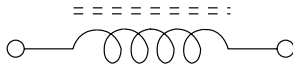

Inductor Connection

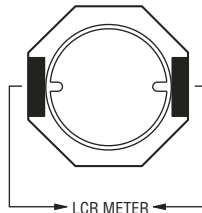

DIMENSIONS: $\frac{\text{MM}}{\text{(INCHES)}}$

Product Dimensions

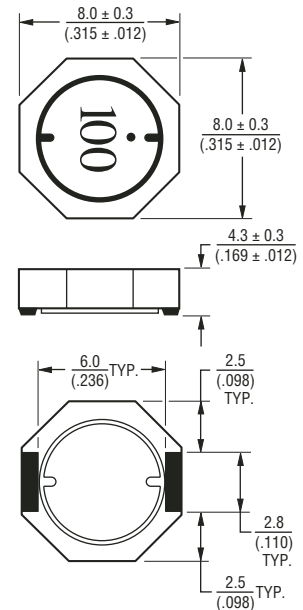

Recommended Layout

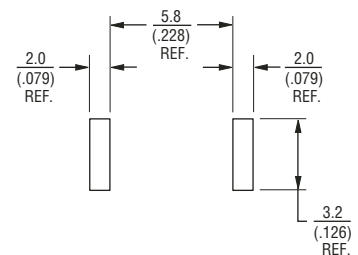

*RoHS Directive 2002/95/EC Jan 27 2003 including Annex
 Specifications are subject to change without notice.
 Customers should verify actual device performance in their specific applications.

SRU8043 Series - Shielded SMD Power Inductors

BOURNS®

Packaging Specifications

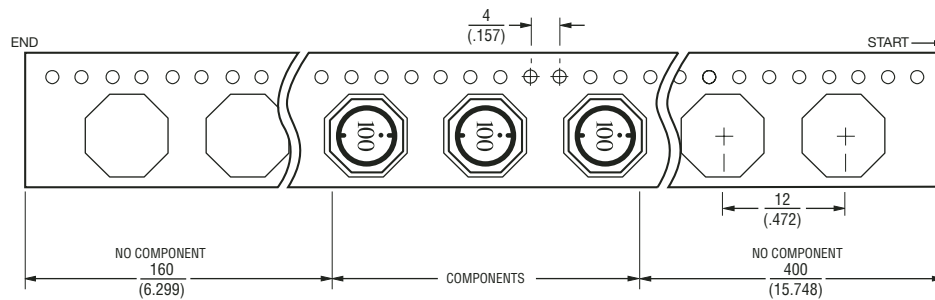
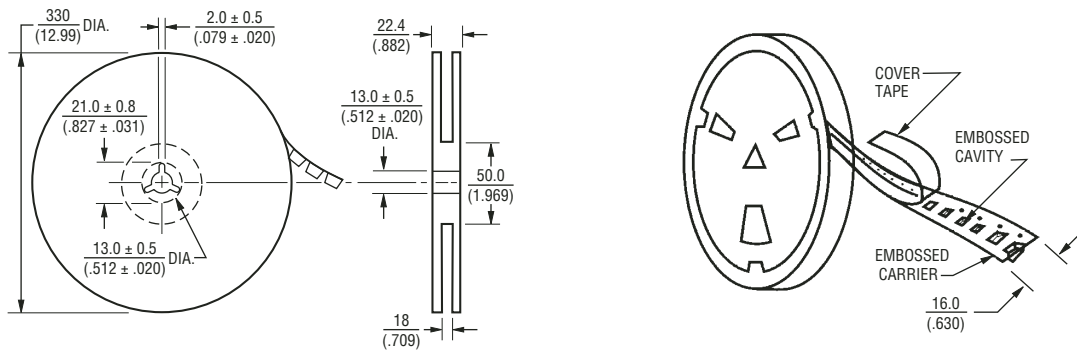

USER DIRECTION OF FEED →

QTY: 1,000 PCS. PER REEL

DIMENSIONS: $\frac{\text{MM}}{\text{(INCHES)}}$