

HMHAA280

HMHA2801 SERIES

HMHA281

DESCRIPTION

The HMHA281, HMHA2801 Series consists of a gallium arsenide infrared emitting diode driving a silicon phototransistor in a compact 4-pin mini-flat package. The lead pitch is 1.27 mm.

The HMHAA280 series consists of two gallium arsenide infrared emitting diodes, connected in inverse parallel, driving a single silicon phototransistor in a compact 4-pin mini-flat package. The lead pitch is 1.27mm.

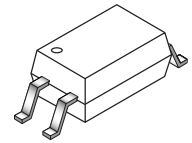

FEATURES

- Compact 4-pin package (2.4 mm maximum standoff height)
- Half pitch leads for optimum board space savings
- Current Transfer Ratio in selected groups
 HMHA2801: 80-600%
 HMHA2801A: 80-160%
 HMHA2801B: 50-150%
 HMHA2801C: 50-100%
 HMHA281: 50-600%
 HMHAA280: 50-600%
- Available in tape and reel quantities of 500 and 2500
- Applicable to Infrared Ray reflow (230°C Max, 30 seconds)
- BSI (File #8611/8612), CSA (File #1201524), UL (File #E90700) and VDE (File #136480) certified

APPLICATIONS

HMHAA280

- AC line monitor
- Unknown polarity DC sensor
- Telephone line receiver

HMHA281, HMHA2801 Series

- Digital logic inputs
- Microprocessor inputs
- Power supply monitor
- Twisted pair line receiver
- Telephone line receiver

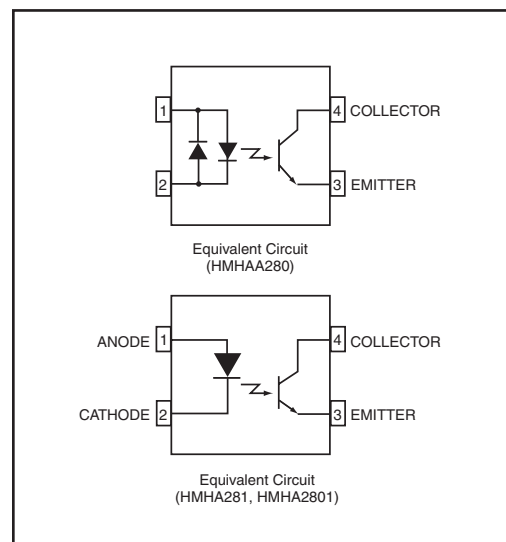
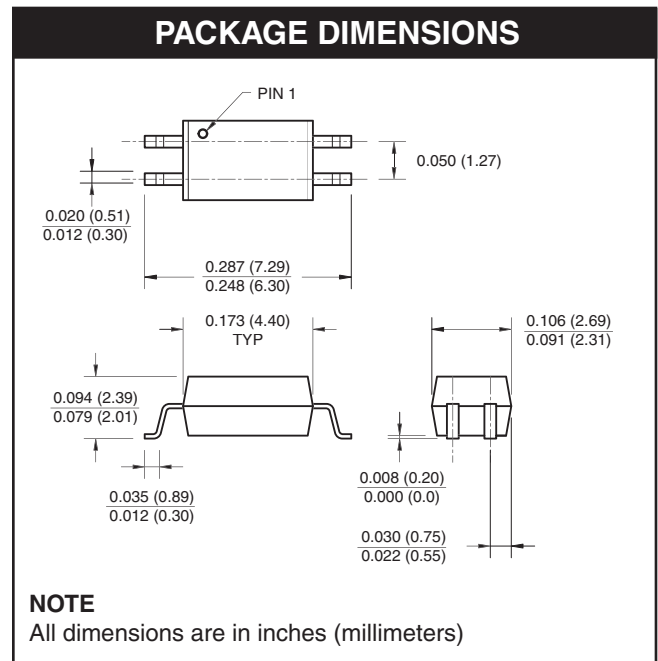

HMHAA280

HMHA2801 SERIES

HMHA281

ABSOLUTE MAXIMUM RATINGS ($T_A = 25^\circ\text{C}$ unless otherwise specified)			
Parameter	Symbol	Value	Units
TOTAL PACKAGE			
Storage Temperature	T_{STG}	-40 to +125	$^\circ\text{C}$
Operating Temperature	T_{OPR}	-40 to +100	$^\circ\text{C}$
EMITTER			
Continuous Forward Current	I_F (avg)	50	mA
Peak Forward Current (1 μs pulse, 300 pps.)	I_F (pk)	1	A
Reverse Input Voltage (HMHA)	V_R	6	V
Power Dissipation	P_D	60	mW
Derate linearly (above 25°C)		0.6	mW/ $^\circ\text{C}$
DETECTOR			
Continuous Collector Current		50	mA
Power Dissipation	P_D	150	mW
Derate linearly (above 25°C)		1.5	mW/ $^\circ\text{C}$
Collector-Emitter Voltage	V_{CEO}	80	V
Emitter-Collector Voltage	V_{ECO}	7	V

ELECTRICAL CHARACTERISTICS ($T_A = 25^\circ\text{C}$)							
INDIVIDUAL COMPONENT CHARACTERISTICS							
Parameter	Test Conditions	Symbol	Device	Min	Typ**	Max	Unit
EMITTER Forward Voltage	$(I_F = 10 \text{ mA})$	V_F	HMHA281	1.0		1.3	V
			HMHA2801				
	$(I_F = 20 \text{ mA})$		HMHA2801A	1.0		1.3	
			HMHA2801B				
			HMHA2801C				
$(I_F = \pm 5 \text{ mA})$	HMHAA280			1.4			
Reverse Current	$(V_R = 5 \text{ V})$	I_R	All			5	μA
DETECTOR							
Breakdown Voltage	$(I_C = 0.5 \text{ mA}, I_F = 0)$	BV_{CEO}	All	80			V
Collector to Emitter							
Emitter to Collector	$(I_E = 100 \mu\text{A}, I_F = 0)$	BV_{ECO}	All	7			
Collector Dark Current	$(V_{CE} = 80 \text{ V}, I_F = 0)$	I_{CEO}	All			100	nA
Capacitance	$(V_{CE} = 0 \text{ V}, f = 1 \text{ MHz})$	C_{CE}	All		10		pF

HMHAA280

HMHA2801 SERIES

HMHA281

TRANSFER CHARACTERISTICS ($T_A = 25^\circ\text{C}$)							
Characteristic	Test Conditions	Symbol	Device	Min	Typ**	Max	Unit
DC Current Transfer Ratio	$(I_F = \pm 5 \text{ mA}, V_{CE} = 5 \text{ V})$	CTR	HMHAA280	50		600	%
			HMHA281	50		600	
	$(I_F = 5 \text{ mA}, V_{CE} = 5 \text{ V})$		HMHA2801	80		600	
			HMHA2801A	80		160	
	$(I_F = 1 \text{ mA}, V_{CE} = 5 \text{ V})$		HMHA2801B	50		150	
			HMHA2801C	50		100	
CTR Symmetry	$(I_F = \pm 5 \text{ mA}, V_{CE} = 5 \text{ V})$	—	HMHAA280	0.33		3.0	
Saturation Voltage	$(I_F = \pm 8 \text{ mA}, I_C = 2.4 \text{ mA})$	$V_{CE(SAT)}$	HMHAA280			0.4	V
			HMHA281			0.4	
	$(I_F = 8 \text{ mA}, I_C = 2.4 \text{ mA})$		HMHA2801			0.3	
			HMHA2801A			0.3	
	$(I_F = 10 \text{ mA}, I_C = 2 \text{ mA})$		HMHA2801B			0.3	
			HMHA2801C			0.2	
Rise Time (Non-Saturated)	$(I_C = 2 \text{ mA}, V_{CE} = 5 \text{ V})$ $(R_L = 100\Omega)$	t_r	All except for HMHA2801C		3		μs
			HMHA2801C			9	
Fall Time (Non-Saturated)	$(I_C = 2 \text{ mA}, V_{CE} = 5 \text{ V})$ $(R_L = 100\Omega)$	t_f	All except for HMHA2801C		3		
			HMHA2801C			9	

ISOLATION CHARACTERISTICS							
Characteristic	Test Conditions	Symbol	Device	Min	Typ**	Max	Unit
Steady State Isolation Voltage	(1 Minute)	V_{ISO}	All	2500			VRMS

** All typicals at $T_A = 25^\circ\text{C}$

TYPICAL PERFORMANCE CURVES

Fig. 1 Forward Current vs. Forward Voltage

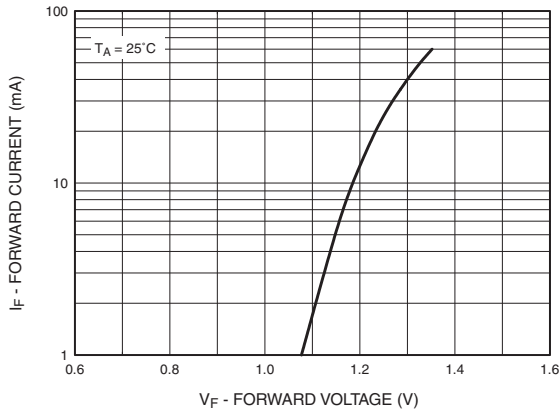

Fig. 2 Collector Current vs. Forward Current

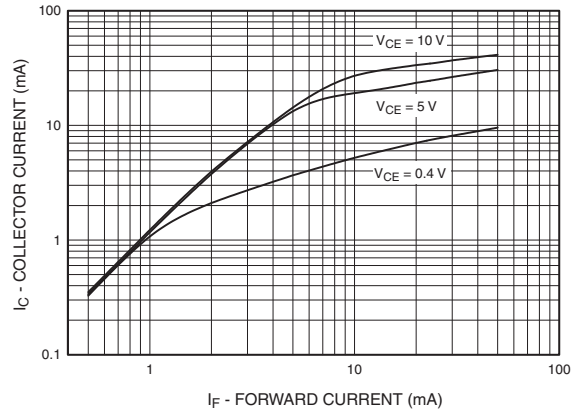

Fig. 3 Current Transfer Ratio vs. Forward Current

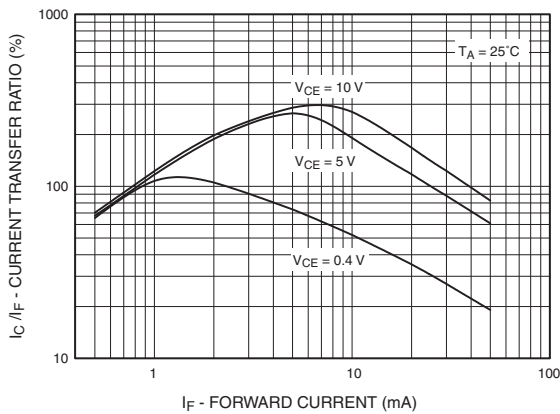

Fig. 4 Normalized CTR vs. Temperature

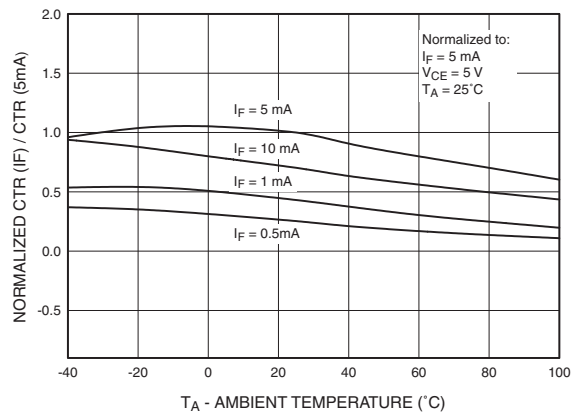

Fig. 5 Collector Current vs. Temperature

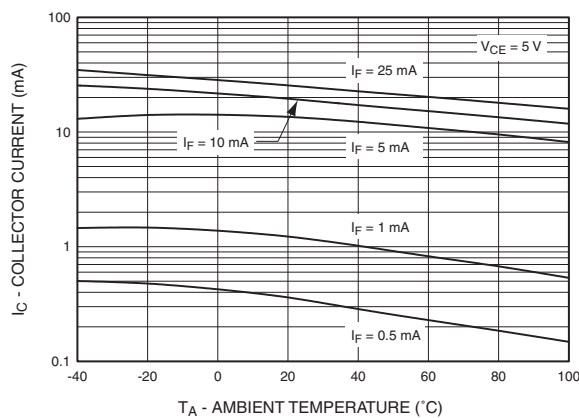

Fig. 6 Collector Current vs. Collector-Emitter Voltage

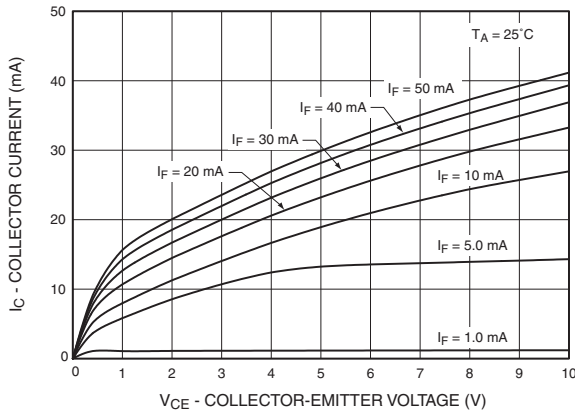

Fig. 7 Collector Current vs. Collector-Emitter Voltage

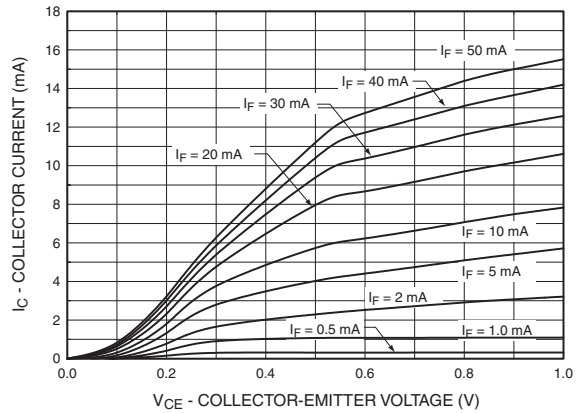

Fig. 8 Collector Dark Current vs. Temperature

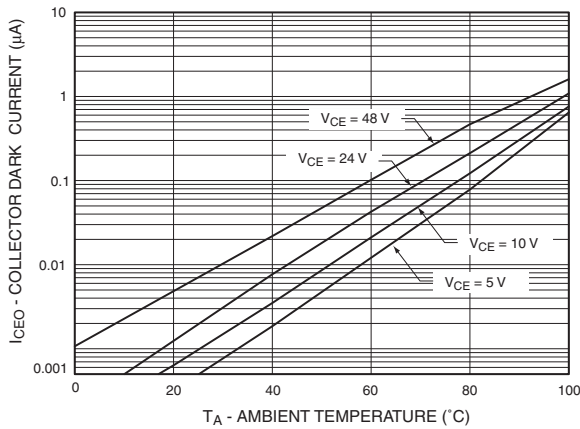

Fig. 9 Switching Time vs. Load Resistance

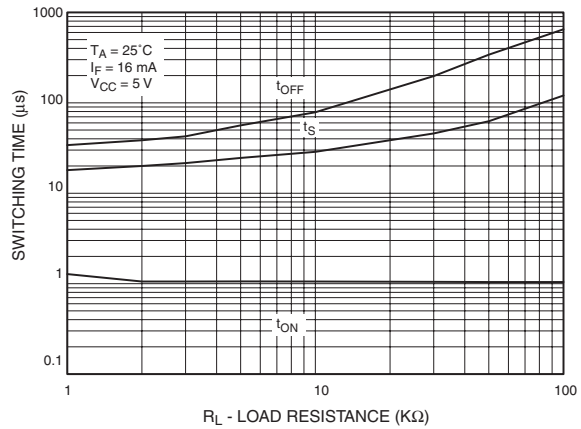
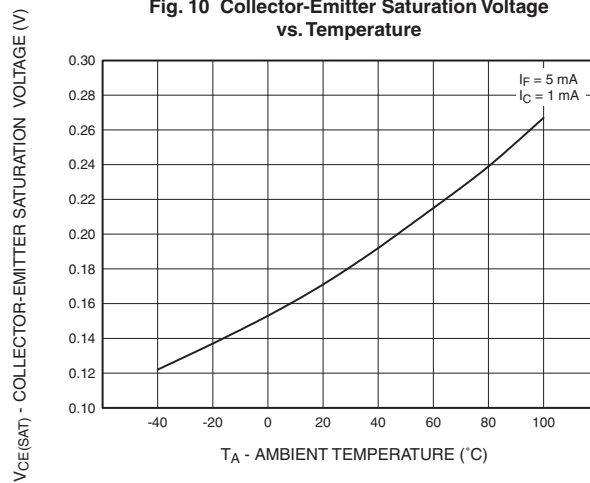

Fig. 10 Collector-Emitter Saturation Voltage vs. Temperature



HMHAA280

HMHA2801 SERIES

HMHA281

ORDERING INFORMATION

Option	Description
V	VDE Approved
R1	Tape and Reel (500 units)
R2	Tape and Reel (2500 units)
R3	Tape and Reel (500 units; unit 180° rotated)
R4	Tape and Reel (2500 units; unit 180° rotated)
R1V	Tape and Reel (500 units) and VDE Approved
R2V	Tape and Reel (2500 units) and VDE Approved
R3V	Tape and Reel (500 units; unit 180° rotated) and VDE Approved
R4V	Tape and Reel (2500 units; unit 180° rotated) and VDE Approved

HMHAA280

HMHA2801 SERIES

HMHA281

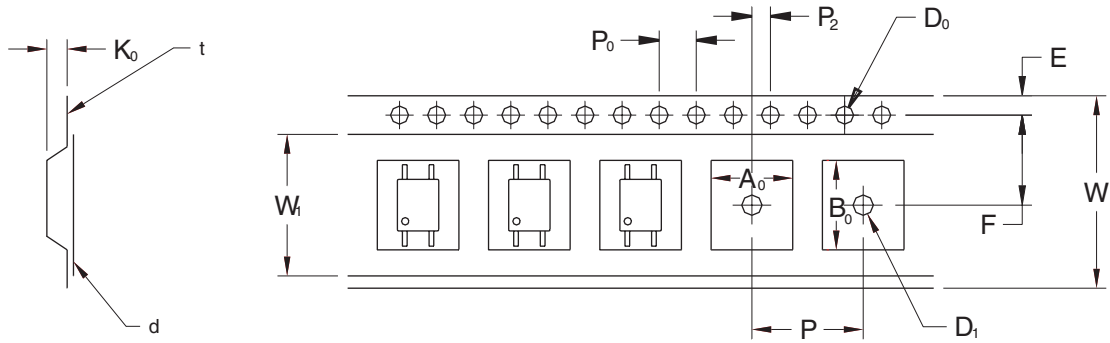

Description		Symbol	1.27 Pitch Dimensions (mm)
Tape Width		W	12.00±0.4
Tape Thickness		t	0.30±0.20
Sprocket Hole Pitch		P ₀	4.00±0.20
Sprocket Hole Dia.		D ₀	1.55±0.20
Sprocket Hole Location		E	1.75±0.20
Pocket Location		F	5.50±0.20
		P ₂	2.00±0.20
Pocket Pitch		P	8.00±0.20
Pocket Dimension		A ₀	4.40±0.20
		B ₀	7.30±0.20
		K ₀	2.30±0.20
Pocket Hole Dia.		D ₁	1.55±0.20
Cover Tape Width		W _f	9.20
Cover Tape Thickness		d	0.065±0.02
Max. Component Rotation or Tilt			20° max
Devices Per Reel		R1	500
		R2	2500
Reel Diameter		R1	178 mm (7")
		R2	330 mm (13")

HMHAA280

HMHA2801 SERIES

HMHA281

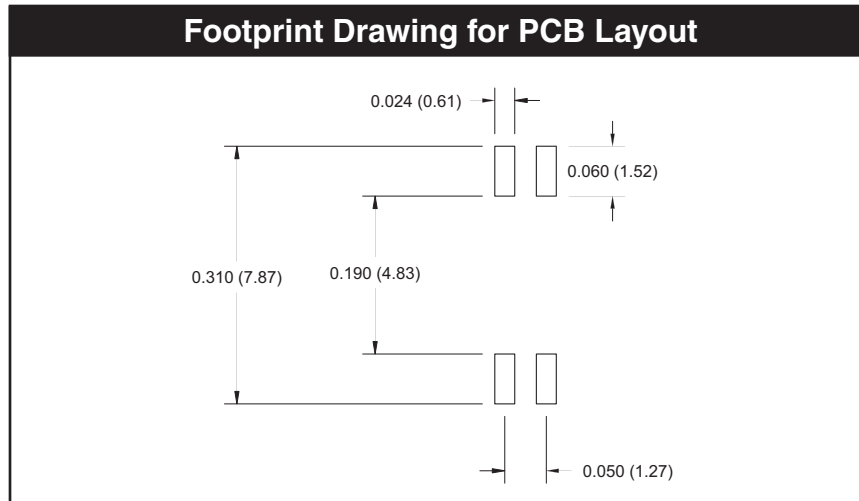

Recommended Infrared Reflow Soldering Profile

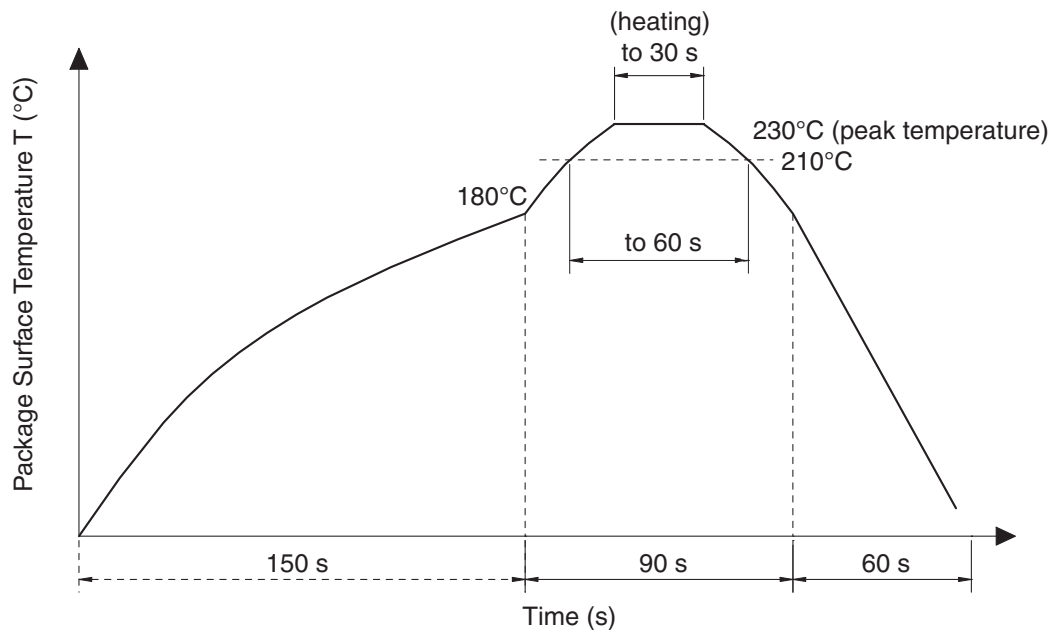

- Peak reflow temperature: 230°C (package surface temperature) for 30 seconds
- Time of temperature higher than 210°C: 60 seconds or less
- One time soldering reflow is recommended

HMHAA280

HMHA2801 SERIES

HMHA281

DISCLAIMER

FAIRCHILD SEMICONDUCTOR RESERVES THE RIGHT TO MAKE CHANGES WITHOUT FURTHER NOTICE TO ANY PRODUCTS HEREIN TO IMPROVE RELIABILITY, FUNCTION OR DESIGN. FAIRCHILD DOES NOT ASSUME ANY LIABILITY ARISING OUT OF THE APPLICATION OR USE OF ANY PRODUCT OR CIRCUIT DESCRIBED HEREIN; NEITHER DOES IT CONVEY ANY LICENSE UNDER ITS PATENT RIGHTS, NOR THE RIGHTS OF OTHERS.

LIFE SUPPORT POLICY

FAIRCHILD'S PRODUCTS ARE NOT AUTHORIZED FOR USE AS CRITICAL COMPONENTS IN LIFE SUPPORT DEVICES OR SYSTEMS WITHOUT THE EXPRESS WRITTEN APPROVAL OF THE PRESIDENT OF FAIRCHILD SEMICONDUCTOR CORPORATION. As used herein:

1. Life support devices or systems are devices or systems which, (a) are intended for surgical implant into the body, or (b) support or sustain life, and (c) whose failure to perform when properly used in accordance with instructions for use provided in the labeling, can be reasonably expected to result in a significant injury of the user.
2. A critical component in any component of a life support device or system whose failure to perform can be reasonably expected to cause the failure of the life support device or system, or to affect its safety or effectiveness.