

Features

- Lead free versions available (see How to Order "Termination" option)
- RoHS compliant (lead free version)*
- Standard E.I.A. package compatible with automatic placement equipment
- Tape and reel packaging standard
- Custom circuits are available

- Marking on contrasting background for permanent identification
- Compliant leads to reduce solder joint fatiguing
- Standard electrical schematics: isolated, bussed, dual terminator
- Now available with improved tolerance to $\pm 0.5\%$

4800P Series - Thick Film Surface Mounted Medium Body

Product Characteristics

Resistance Range

.....10 ohms to 2.2 megohms

Maximum Operating Voltage.....50 V

Temperature Coefficient of Resistance

50 ohms and above..... ± 100 ppm/ $^{\circ}$ C

below 50 ohms..... ± 250 ppm/ $^{\circ}$ C

TCR Tracking

(for equal values within a package)

..50 ppm/ $^{\circ}$ C max. for values > 50 ohms;

.....100 ppm/ $^{\circ}$ C for values \leq 50 ohms

Operating Temperature

.....-55 $^{\circ}$ C to +125 $^{\circ}$ C

Insulation Resistance

.....10,000 megohms min.

Dielectric Withstanding Voltage

.....200 VRMS

Lead Solderability

.....Meet requirements of MIL-STD-202 Method 208

Environmental Characteristics

TESTS PER MIL-STD-202 ΔR MAX.

Short Time Overload..... $\pm 0.25\%$

Load Life..... $\pm 1.00\%$

Moisture Resistance..... $\pm 0.50\%$

Resistance to Soldering Heat..... $\pm 0.25\%$

Thermal Shock..... $\pm 0.25\%$

Physical Characteristics

Flammability.....Conforms to UL94V-0

Lead Frame Material

.....Copper, solder coated

Body Material.....Thermoplastic

How To Order

48 16 P - 1 - 103

Model _____
(48 = SOM Pkg)

Number of Pins _____

Electrical Configuration _____

• 1 or 4 = Isolated*

• 2 = Bussed*

• 3 = Dual Terminator*

Resistance Code _____

• First 2 digits are significant

• Third digit represents the number of zeros to follow.

Resistance Tolerance _____

• Blank = $\pm 2\%$ (see "Resistance Tolerance" on next page for resistance range)

• F = $\pm 1\%$ (100 ohms - 1 megohm)

• D = $\pm 0.5\%$ (100 ohms - 1 megohm)

Terminations _____

• All electrical configurations EXCEPT T03:

LF = Tin-plated (lead free)

• ONLY electrical configuration T03:

L = Tin-plated (lead free)

• Blank = Tin/Lead-plated

*For tube packaging, use T01, T02, T03 or T04.

Consult factory for other available options.

Package Power Temp. Derating Curve

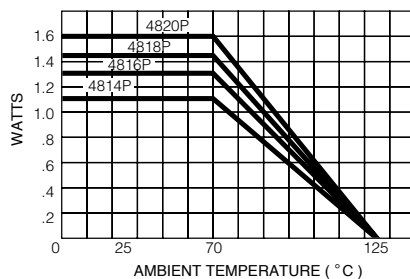

Package Power Rating at 70 $^{\circ}$ C

4814P.....	1.12 watts
4816P.....	1.28 watts
4818P.....	1.44 watts
4820P.....	1.60 watts

Typical Part Marking

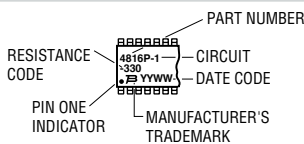

Recommended Land Pattern

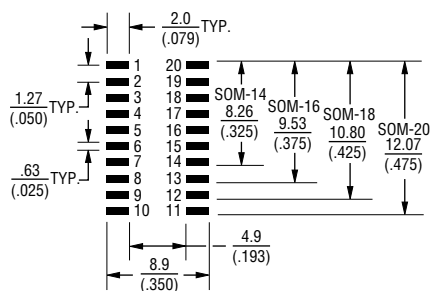

NOTE: Land pattern dimensions are based on design rules established by the Institute for Interconnecting and Packaging Electronic Circuits in IPC-SM-782.

For Standard Values Used in Capacitors, Inductors, and Resistors, [click here](#).

Product Dimensions

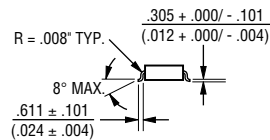
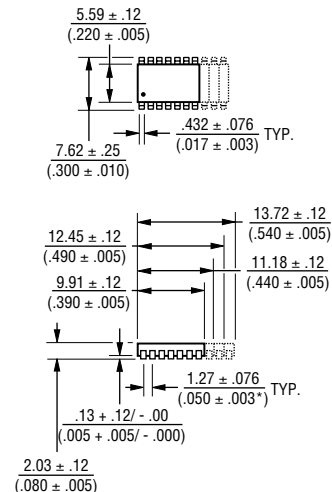

Lead coplanarity .102mm (.004 inch) max. at mounting surface.

Governing dimensions are in metric. Dimensions in parentheses are inches and are approximate.

*Terminal centerline to centerline measurements made at point of emergence of the lead from the body.

For information on specific applications, download Bourns' application notes:

- [DRAM Applications](#)
- [Dual Terminator Resistor Networks](#)
- [R/2R Ladder Networks](#)
- [SCSI Applications](#)

4800P Series - Thick Film Surface Mounted Medium Body



Isolated Resistors (1 And 4 Circuits)

Model 4814P-1
Model 4816P-1 (Shown)
Model 4818P-1
Model 4820P-1

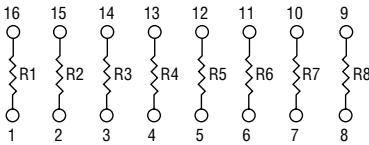

Model 4816P-4 (Shown)
Model 4820P-4

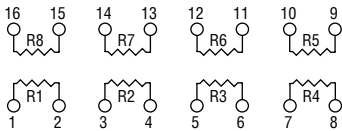

Resistance Tolerance

10 ohms to 49 ohms±1 ohm
 50 ohms to 2.2 megohms.....±2 %*

Power Rating per Resistor

1 Circuit at 70 °C0.160 watt
 4 Circuit at 70 °C0.160 watt

Resistor Power Temp. Derating Curve

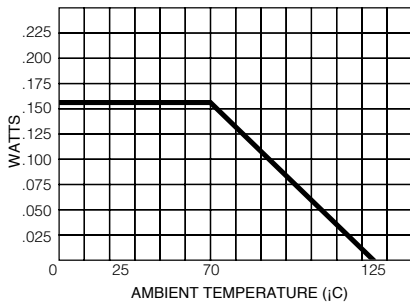

Bussed Resistors (2 Circuit)

Model 4814P-2
Model 4816P-2 (Shown)
Model 4818P-2
Model 4820P-2

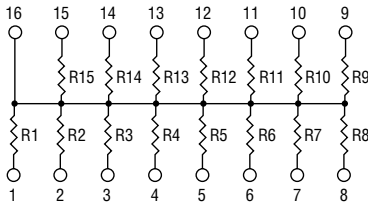

Resistance Tolerance

10 ohms to 49 ohms±1 ohm
 50 ohms to 2.2 megohms±2 %*

Power Rating per Resistor

2 Circuit at 70 °C0.080 watt

Resistor Power Temp. Derating Curve

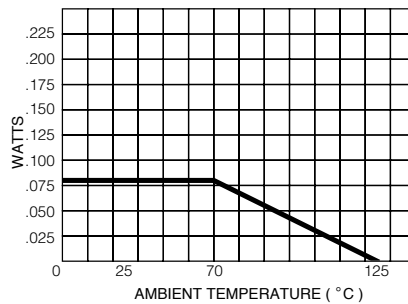

Dual Terminator (3 Circuit)

Model 4814P-3
Model 4816P-3 (Shown)
Model 4818P-3
Model 4820P-3

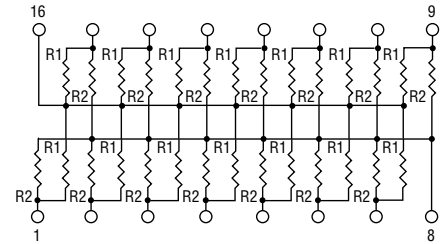

Resistance Tolerance

Below 100 ohms±2 ohms
 100 ohms to 2.2 megohms±2 %*

Power Rating per Resistor

3 Circuit at 70 °C0.080 watt

Resistor Power Temp. Derating Curve

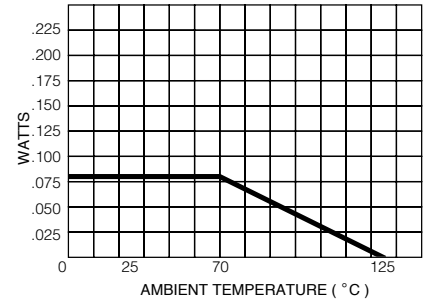

Popular Resistance Values (1, 4, And 2 Circuits)**

Ohms	Code	Ohms	Code	Ohms	Code	Ohms	Code	Ohms	Code
10	100	180	181	1,800	182	15,000	153	120,000	124
22	220	220	221	2,000	202	18,000	183	150,000	154
27	270	270	271	2,200	222	20,000	203	180,000	184
33	330	330	331	2,700	272	22,000	223	220,000	224
39	390	390	391	3,300	332	27,000	273	270,000	274
47	470	470	471	3,900	392	33,000	333	330,000	334
56	560	560	561	4,700	472	39,000	393	390,000	394
68	680	680	681	5,600	562	47,000	473	470,000	474
82	820	820	821	6,800	682	56,000	563	560,000	564
100	101	1,000	102	8,200	822	68,000	683	680,000	684
120	121	1,200	122	10,000	103	82,000	823	820,000	824
150	151	1,500	152	12,000	123	100,000	104	1,000,000	105

Popular Resistance Values (3 Circuit)**

Resistance			
(Ohms)		Code	
R ₁	R ₂	R ₁	R ₂
160	240	161	241
180	390	181	391
220	270	221	271
220	330	221	331
330	390	331	391
330	470	331	471
3,000	6,200	302	622

* ADD "F" AFTER RESISTANCE CODE FOR ±1 % TOLERANCE AVAILABLE FROM 100 OHMS THROUGH 1 MEGOHM, OR ADD "D" AFTER RESISTANCE CODE FOR ±0.5 % TOLERANCE AVAILABLE FROM 100 OHMS THROUGH 1 MEGOHM.

PART NUMBER SUFFIX EXAMPLES: -103 = 10K OHMS, ±2 % -103F = 10K OHMS, ±1 % -103D = 10K OHMS, ±0.5 %

** NON-STANDARD VALUES AVAILABLE, WITHIN RESISTANCE RANGE.

REV. 04/06

Specifications are subject to change without notice.
 Customers should verify actual device performance in their specific applications.

Surface Mounted Ordering Guide



Electrical Configuration	*Circuit Codes		Examples
	Tape & Reel	Tubes	
Isolated	1	T01	4816P-1-101
Bussed	2	T02	Isolated Circuit in Tape & Reel Package
Dual Terminated	3	T03	4816P-T01-101
Adj. Isolated	4	T04	Isolated Circuit in Slide Tube Package

*4816P-X-RC: To specify package type, replace "X" with appropriate "Circuit Code".

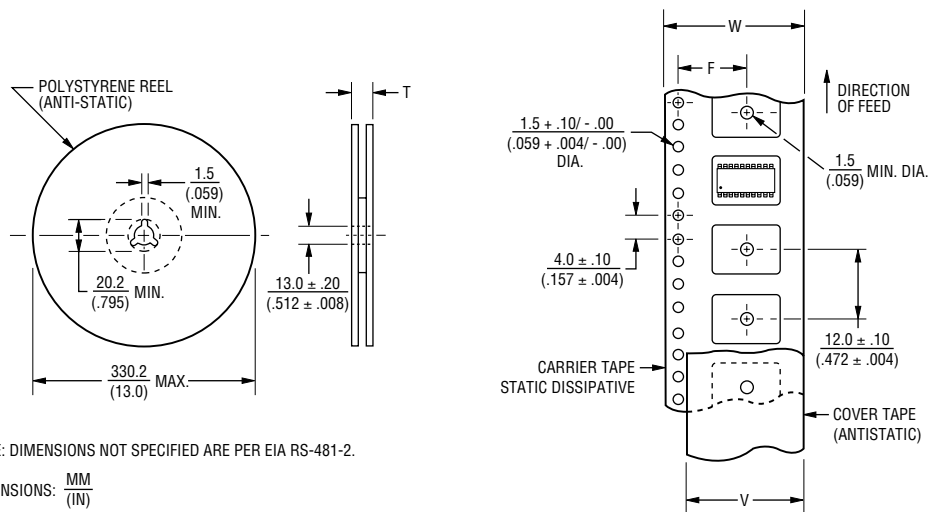

Model	Standard Quantity Per Reel	Carrier Tape Width (W)	Cover Tape Width (V)	Reel Width (T)	Pocket Center (F)
4814P 4816P 4818P 4820P	2,000	$24.0 \pm .30$ (.945 ± .012)	21.0 (.827) NOM.	30.4 (1.197) MAX.	$11.5 \pm .10$ (.453 ± .004)

Leader Length = 500 min.
Trailer Length = 500 mm min. } Empty Component Pockets Sealed with Cover Tape