

FMS7G15US60

Compact & Complex Module

Features

- Short Circuit rated $10\mu\text{s}$ @ $T_C = 100^\circ\text{C}$, $V_{GE} = 15\text{V}$
- High Speed Switching
- Low Saturation Voltage : $V_{CE(\text{sat})} = 2.1\text{V}$ @ $I_C = 15\text{A}$
- High Input Impedance
- Built in Brake & 3 Phase Rectifier Circuit
- Fast & Soft Anti-Parallel FWD
- Built-in NTC Thermistor

Applications

- AC & DC Motor Controls
- General Purpose Inverters
- Robotics
- Servo Controls

Description

Fairchild IGBT Power Module provides low conduction and switching losses as well as short circuit ruggedness. It's designed for the applications such as motor control and general inverters where short-circuit ruggedness is required.

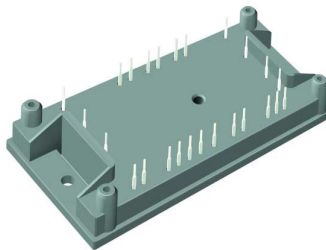

Package Code : 25PM-AA

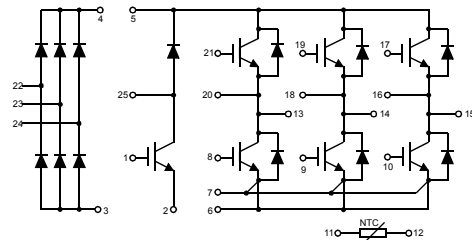

Internal Circuit Diagram

Absolute Maximum Ratings T_C = 25°C unless otherwise noted

	Symbol	Description	FMS7G15US60	Units
Inverter & Brake	V _{CES}	Collector-Emitter Voltage	600	V
	V _{GES}	Gate-Emitter Voltage	± 20	V
	I _C	Collector Current @ T _C = 80°C	15	A
	I _{CM(1)}	Pulsed Collector Current	30	A
	I _F	Diode Continuous Forward Current @ T _C = 80°C	15	A
	I _{FM}	Diode Maximum Forward Current	30	A
	P _D	Maximum Power Dissipation @ T _C = 25°C	73	W
	T _{SC}	Short Circuit Withstand Time @ T _C = 100°C	10	µs
Converter	V _{RPM}	Repetitive Peak Reverse Voltage	1600	V
	I _O	Average Output Rectified Current	20	A
	I _{FSM}	Surge Forward Current @ 1Cycle at 60Hz, Peak value Non-Repetitive	200	A
	i ² t	Energy pulse @ 1Cycle at 60Hz	164	A ² s
Common	T _J	Operating Junction Temperature	-40 to +150	°C
	T _{STG}	Storage Temperature Range	-40 to +125	°C
	V _{ISO}	Isolation Voltage @ AC 1minute	2500	V
Mounting Torque	Mounting part Screw @ M4	2.0	N·m	

Notes :

(1) Repetitive rating : Pulse width limited by max. junction temperature

Package Marking and Ordering Information

Device Marking	Device	Package	Reel Size	Tape Width	Quantity
FMS7G15US60	FMS7G15US60	25PM-AA	--	--	--

(2) TMC2 Reliability test was done under -45°C ~ 125°C

Electrical Characteristics of IGBT @ Inverter $T_C = 25^\circ\text{C}$ unless otherwise noted

Symbol	Parameter	Test Conditions	Min.	Typ.	Max.	Units
Off Characteristics						
BV_{CES}	Collector-Emitter Breakdown Voltage	$V_{GE} = 0V, I_C = 250\mu A$	600	--	--	V
$\frac{\Delta BV_{CES}}{\Delta T_J}$	Temperature Coeff. of Breakdown Voltage	$V_{GE} = 0V, I_C = 1mA$	--	0.6	--	V/ $^\circ\text{C}$
I_{CES}	Collector Cut-Off Current	$V_{CE} = V_{CES}, V_{GE} = 0V$	--	--	250	μA
I_{GES}	Gate - Emitter Leakage Current	$V_{GE} = V_{GES}, V_{CE} = 0V$	--	--	± 100	nA
On Characteristics						
$V_{GE(th)}$	Gate - Emitter Threshold Voltage	$I_C = 15mA, V_{CE} = V_{GE}$	5.0	6.5	8.5	V
$V_{CE(sat)}$	Collector to Emitter Saturation Voltage	$I_C = 15A, V_{GE} = 15V$	--	2.1	2.7	V
Dynamic Characteristics						
C_{ies}	Input Capacitance	$V_{CE} = 30V, V_{GE} = 0V,$ $f = 1MHz$	--	935	--	pF
C_{oes}	Output Capacitance		--	81	--	pF
C_{res}	Reverse Transfer Capacitance		--	18	--	pF
Switching Characteristics						
$t_{d(on)}$	Turn-On Delay Time	$V_{CC} = 300V, I_C = 15A,$ $R_G = 13\Omega, V_{GE} = 15V,$ Inductive Load, $T_C = 25^\circ\text{C}$	--	65	130	ns
t_r	Rise Time		--	80	160	ns
$t_{d(off)}$	Turn-Off Delay Time		--	80	160	ns
t_f	Fall Time		--	100	200	ns
E_{on}	Turn-On Switching Loss		--	0.3	--	mJ
E_{off}	Turn-Off Switching Loss		--	0.3	--	mJ
$t_{d(on)}$	Turn-On Delay Time	$V_{CC} = 300V, I_C = 15A,$ $R_G = 13\Omega, V_{GE} = 15V,$ Inductive Load, $T_C = 125^\circ\text{C}$	--	70	140	ns
t_r	Rise Time		--	80	160	ns
$t_{d(off)}$	Turn-Off Delay Time		--	90	180	ns
t_f	Fall Time		--	210	350	ns
E_{on}	Turn-On Switching Loss		--	0.33	--	mJ
E_{off}	Turn-Off Switching Loss		--	0.5	--	mJ
T_{sc}	Short Circuit Withstand Time	$V_{CC} = 300V, V_{GE} = 15V$ @ $T_C = 100^\circ\text{C}$	10	--	--	μs
Q_g	Total Gate Charge	$V_{CE} = 300V, I_C = 15A,$ $V_{GE} = 15V$	--	45	60	nC
Q_{ge}	Gate-Emitter Charge		--	9	15	nC
Q_{gc}	Gate-Collector Charge		--	17	30	nC

Electrical Characteristics of DIODE @ Inverter T_C = 25°C unless otherwise noted

Symbol	Parameter	Test Conditions	Min.	Typ.	Max.	Units	
V _{FM}	Diode Forward Voltage	I _F = 15A	T _C = 25°C	--	1.9	2.8	V
			T _C = 100°C	--	2.0	--	
t _{rr}	Diode Reverse Recovery Time	I _F = 15A di / dt = 30 A/μs	T _C = 25°C	--	75	150	ns
			T _C = 100°C	--	100	--	
I _{rr}	Diode Peak Reverse Recovery Current		T _C = 25°C	--	1.0	2.0	A
			T _C = 100°C	--	1.3	--	
Q _{rr}	Diode Reverse Recovery Charge		T _C = 25°C	--	40	150	nC
			T _C = 100°C	--	65	--	

Electrical Characteristics of DIODE @ Converter T_C = 25°C unless otherwise noted

Symbol	Parameter	Test Conditions	Min.	Typ.	Max.	Units	
V _{FM}	Diode Forward Voltage	I _F = 20A	T _C = 25°C	--	1.1	1.5	V
			T _C = 100°C	--	1.0	--	
I _{RRM}	Repetitive Reverse Current	V _R = V _{RRM}	T _C = 25°C	--	--	8	mA
			T _C = 100°C	--	5	--	

Thermal Characteristics

	Symbol	Parameter	Typ.	Max.	Units
Inverter	R _{θJC}	Junction-to-Case (IGBT Part, per 1/6 Module)	--	1.7	°C/W
	R _{θJC}	Junction-to-Case (DIODE Part, per 1/6 Module)	--	2.5	°C/W
Brake	R _{θJC}	Junction-to-Case (IGBT Part)	--	1.7	°C/W
	R _{θJC}	Junction-to-Case (DIODE Part)	--	2.5	°C/W
Converter	R _{θJC}	Junction-to-Case (DIODE Part, per 1/6 Module)	--	1.5	°C/W
Weight		Weight of Module	60	--	g

NTC Thermistor Characteristics

	Symbol	Parameter	Tol.	Typ.	Units
Thermistor	R25	Rated Resistance @ T _c = 25°C	+/- 5 %	4.7	KΩ
	B(25/100)	B - Value	+/- 3 %	3530	

Typical Performance Characteristics

Figure 1. Typical Output Characteristics

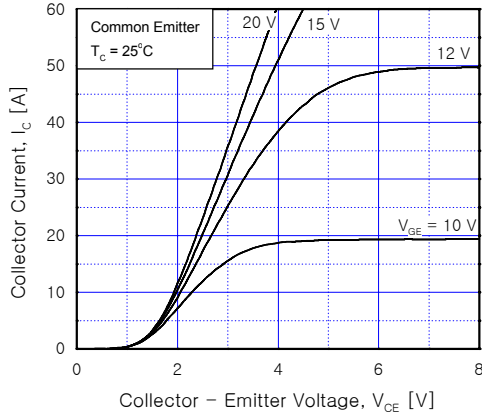

Figure 2. Typical Saturation Voltage Characteristics

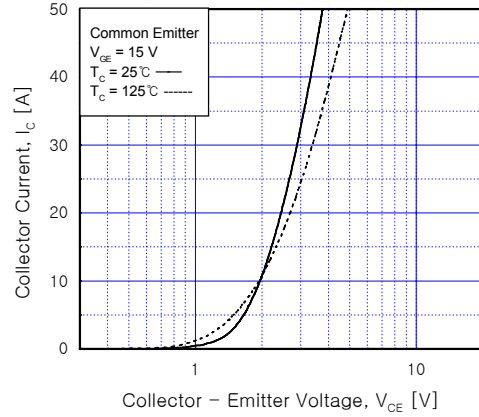

Figure 3. Saturation Voltage vs. Case Temperature at Variant Current Level

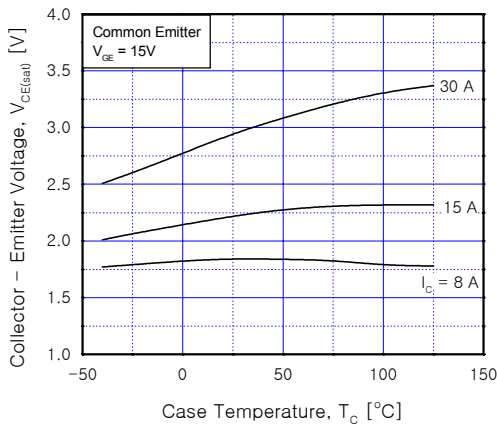

Figure 4. Transient Thermal Impedance

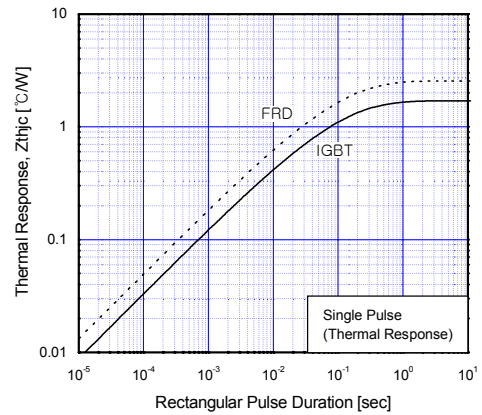

Figure 5. Saturation Voltage vs. V_GE

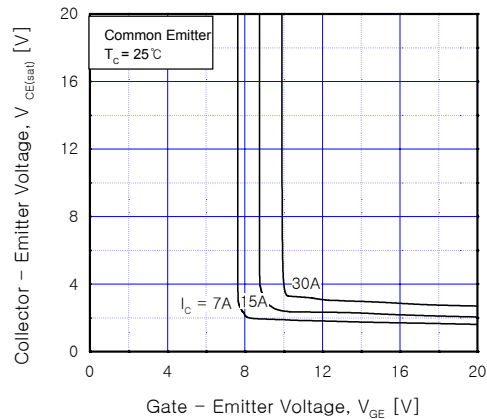
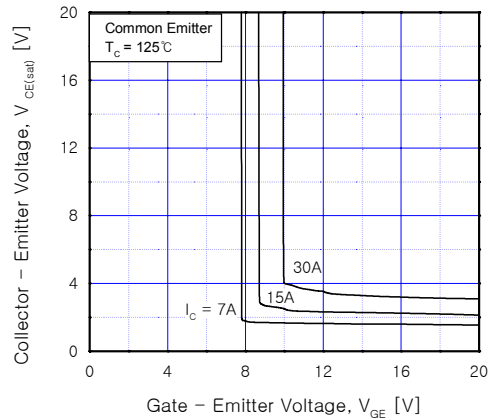

Figure 6. Saturation Voltage vs. V_GE



Typical Performance Characteristics (Continued)

Figure 7. Capacitance Characteristics

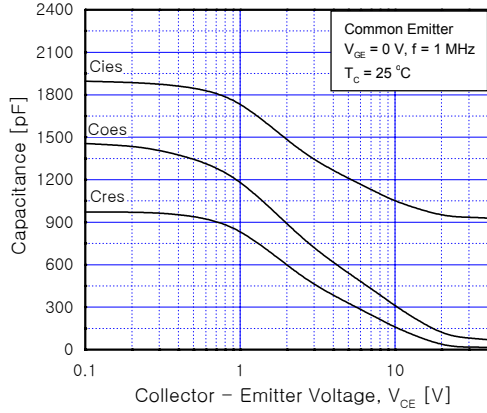

Figure 8. Turn-On Characteristics vs. Gate Resistance

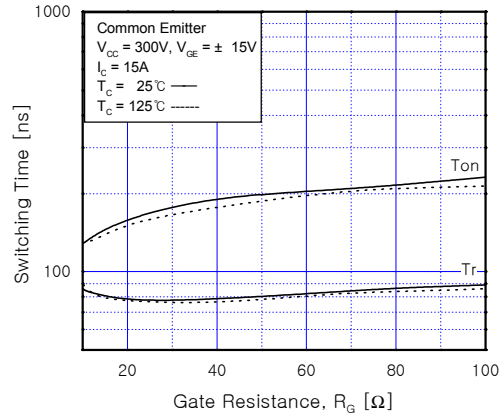

Figure 9. Turn-Off Characteristics vs. Gate Resistance

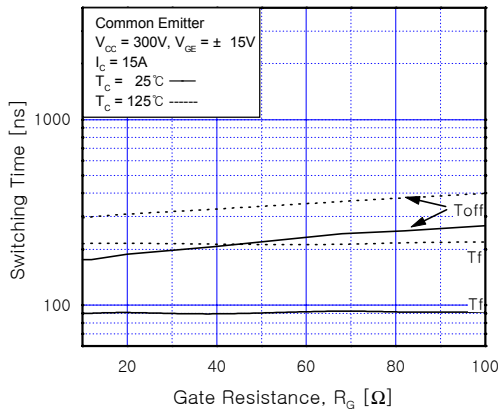

Figure 10. Switching Loss vs. Gate Resistance

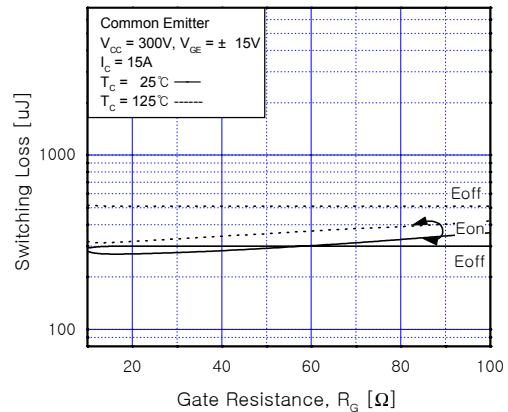

Figure 11. Turn-On Characteristics vs. Collector Current

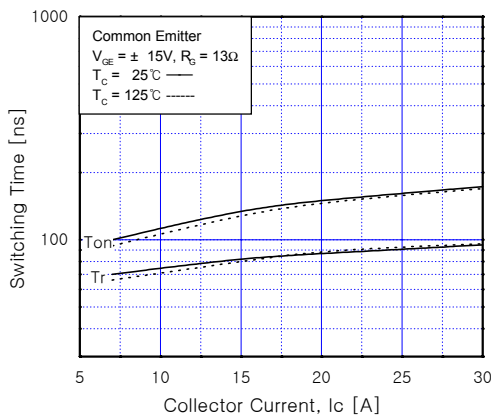
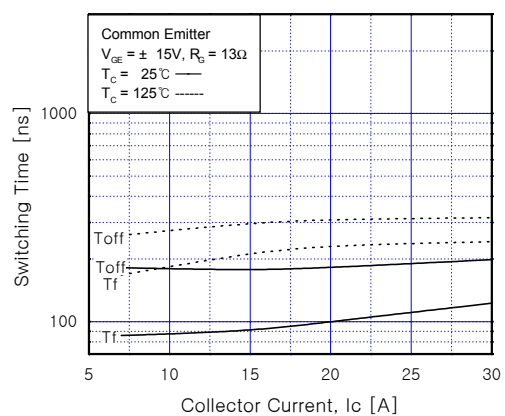

Figure 12. Turn-Off Characteristics vs. Collector Current



Typical Performance Characteristics (Continued)

Figure 13. Switching Loss vs. Collector Current

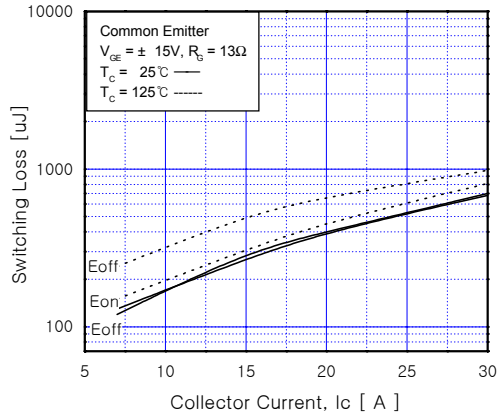

Figure 14. Gate Charge Characteristics

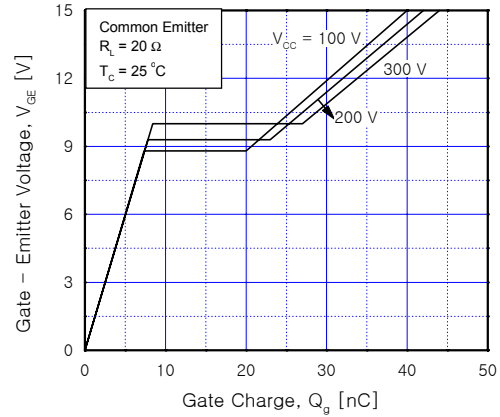

Figure 15. SOA Characteristics

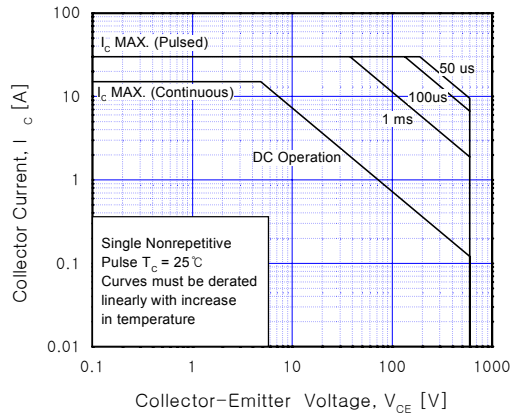

Figure 16. RBSOA Characteristics

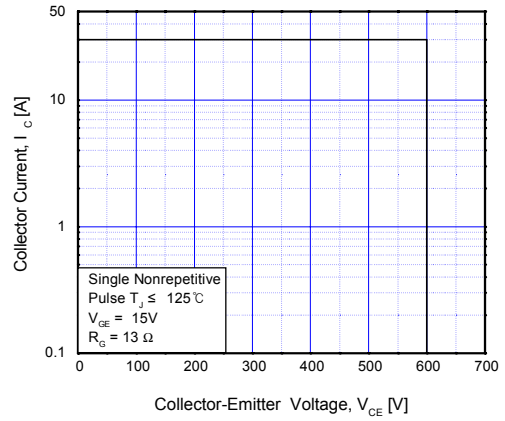

Figure 17. Forward Characteristics

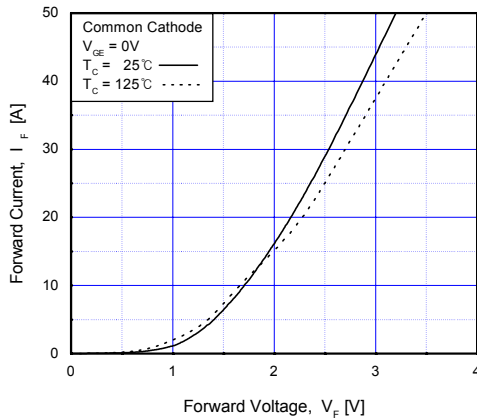
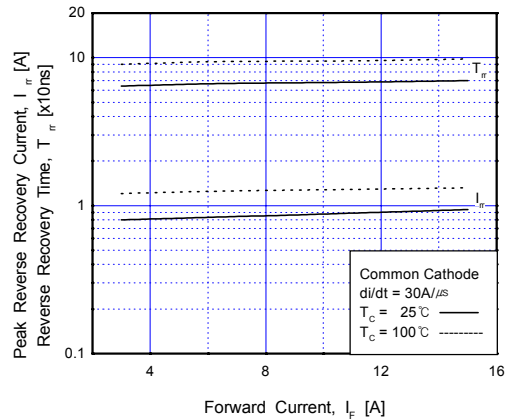

Figure 18. Reverse Recovery Characteristics



Typical Performance Characteristics (Continued)

Figure 19. Rectifier (Converter) Characteristics

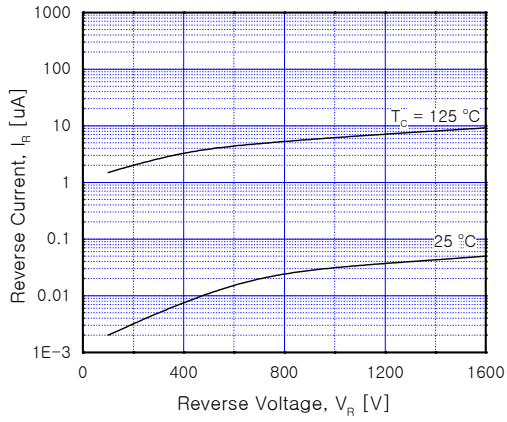

Figure 20. Rectifier (Converter) Characteristics

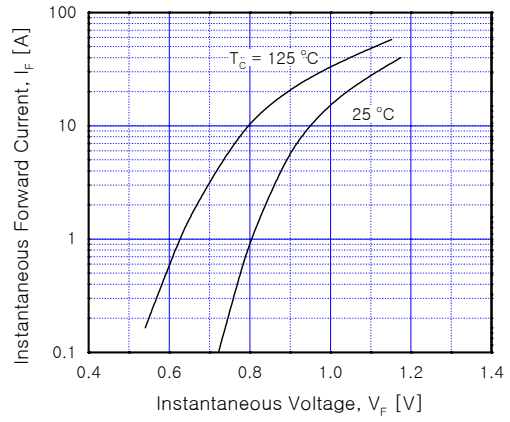
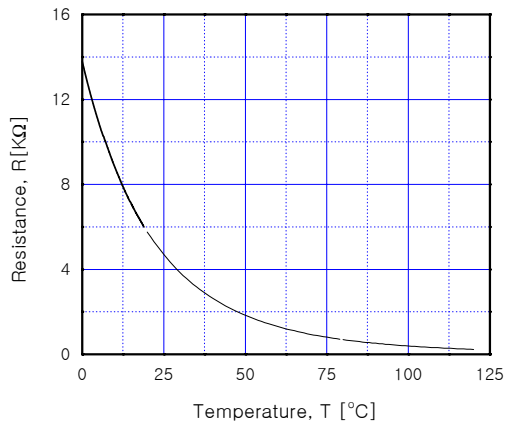
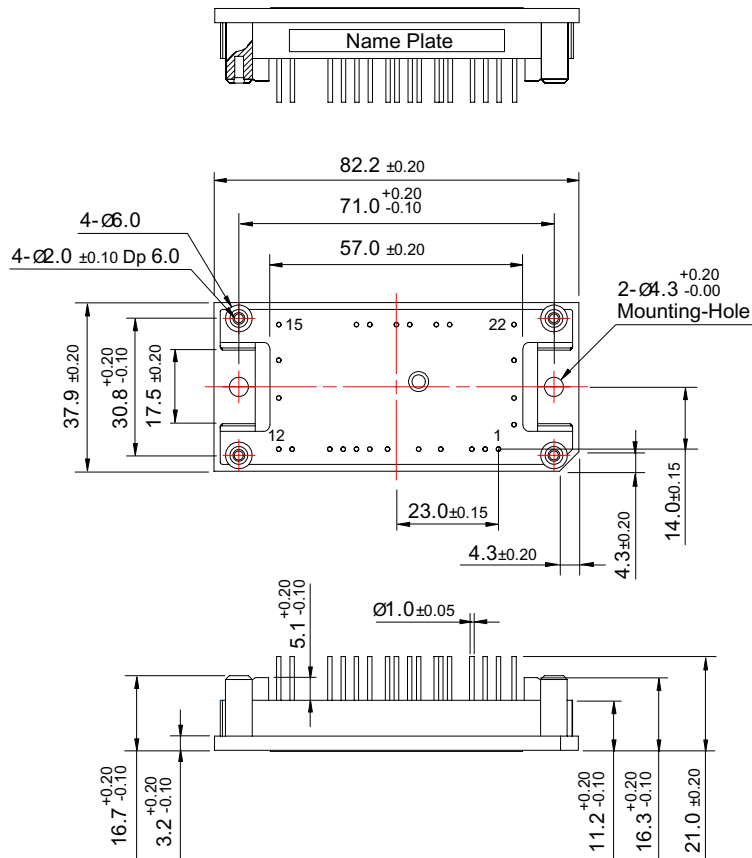

Figure 21. NTC Characteristics



Mechanical Dimensions

25PM-AA



- Pin Coordinate

Pin #No	Coordinate	
	x	y
1	0.0	0.0
2	-3.0	0.0
3	-6.0	0.0
4	-13.0	0.0
5	-18.0	0.0
6	-25.0	0.0
7	-29.0	0.0
8	-32.0	0.0
9	-35.0	0.0
10	-38.0	0.0
11	-46.5	0.0
12	-49.5	0.0
13	-49.5	11.5
14	-49.5	20.0
15	-49.5	28.0
16	-32.0	28.0
17	-29.0	28.0
18	-23.0	28.0
19	-20.0	28.0
20	-14.0	28.0
21	-11.0	28.0
22	3.5	28.0
23	3.5	20.0
24	3.5	11.5
25	3.5	5.5

* datum pin : #1

* Pin Tilt : ±0.15

Dimensions in Millimeters

TRADEMARKS

The following are registered and unregistered trademarks Fairchild Semiconductor owns or is authorized to use and is not intended to be an exhaustive list of all such trademarks.

ACEx™	FAST®	ISOPLANAR™	PowerSaver™	SuperSOT™-8
ActiveArray™	FASTr™	LittleFET™	PowerTrench®	SyncFET™
Bottomless™	FPS™	MICROCOUPLER™	QFET®	TinyLogic®
Build it Now™	FRFET™	MicroFET™	QS™	TINYOPTO™
CoolFET™	GlobalOptoisolator™	MicroPak™	QT Optoelectronics™	TruTranslation™
CROSSVOLT™	GTO™	MICROWIRE™	Quiet Series™	UHC™
DOME™	HiSeC™	MSX™	RapidConfigure™	UltraFET®
EcoSPARK™	I ² C™	MSXPro™	RapidConnect™	UniFET™
E ² CMOS™	i-Lo™	OCX™	μSerDes™	VCX™
EnSigna™	ImpliedDisconnect™	OCXPro™	SILENT SWITCHER®	Wire™
FACT™	IntelliMAX™	OPTOLOGIC®	SMART START™	
FACT Quiet Series™		OPTOPLANAR™	SPM™	
Across the board. Around the world.™		PACMAN™	Stealth™	
The Power Franchise®		POP™	SuperFET™	
Programmable Active Droop™		Power247™	SuperSOT™-3	
		PowerEdge™	SuperSOT™-6	

DISCLAIMER

FAIRCHILD SEMICONDUCTOR RESERVES THE RIGHT TO MAKE CHANGES WITHOUT FURTHER NOTICE TO ANY PRODUCTS HEREIN TO IMPROVE RELIABILITY, FUNCTION OR DESIGN. FAIRCHILD DOES NOT ASSUME ANY LIABILITY ARISING OUT OF THE APPLICATION OR USE OF ANY PRODUCT OR CIRCUIT DESCRIBED HEREIN; NEITHER DOES IT CONVEY ANY LICENSE UNDER ITS PATENT RIGHTS, NOR THE RIGHTS OF OTHERS.

LIFE SUPPORT POLICY

FAIRCHILD'S PRODUCTS ARE NOT AUTHORIZED FOR USE AS CRITICAL COMPONENTS IN LIFE SUPPORT DEVICES OR SYSTEMS WITHOUT THE EXPRESS WRITTEN APPROVAL OF FAIRCHILD SEMICONDUCTOR CORPORATION.

As used herein:

1. Life support devices or systems are devices or systems which, (a) are intended for surgical implant into the body, or (b) support or sustain life, or (c) whose failure to perform when properly used in accordance with instructions for use provided in the labeling, can be reasonably expected to result in significant injury to the user.
2. A critical component is any component of a life support device or system whose failure to perform can be reasonably expected to cause the failure of the life support device or system, or to affect its safety or effectiveness.

PRODUCT STATUS DEFINITIONS

Definition of Terms

Datasheet Identification	Product Status	Definition
Advance Information	Formative or In Design	This datasheet contains the design specifications for product development. Specifications may change in any manner without notice.
Preliminary	First Production	This datasheet contains preliminary data, and supplementary data will be published at a later date. Fairchild Semiconductor reserves the right to make changes at any time without notice in order to improve design.
No Identification Needed	Full Production	This datasheet contains final specifications. Fairchild Semiconductor reserves the right to make changes at any time without notice in order to improve design.
Obsolete	Not In Production	This datasheet contains specifications on a product that has been discontinued by Fairchild semiconductor. The datasheet is printed for reference information only.

Rev. I16