

DS36277 Dominant Mode Multipoint Transceiver

General Description

The DS36277 Dominant Mode Multipoint Transceiver is designed for use on bi-directional differential busses. It is optimal for use on Interfaces that utilize Society of Automotive Engineers (SAE) J1708 Electrical Standard.

The device is similar to standard TIA/EIA-485 transceivers, but differs in enabling scheme. The Driver's Input is normally externally tied LOW, thus providing only two states: Active (LOW), or Disabled (OFF). When the driver is active, the dominant mode is LOW, conversely, when the driver is disabled, the bus is pulled HIGH by external bias resistors.

The receiver provides a FAILSAFE feature that guarantees a known output state when the Interface is in the following conditions: Floating Line, Idle Line (no active drivers), and Line Fault Conditions (open or short). The receiver output is HIGH for the following conditions: Open Inputs, Terminated Inputs (50Ω), or Shorted Inputs. FAILSAFE is a highly desirable feature when the transceivers are used with Asynchronous Controllers such as UARTs.

Features

- FAILSAFE receiver, RO = HIGH for:
 - OPEN inputs
 - Terminated inputs
 - SHORTED inputs
- Optimal for use in SAE J1708 Interfaces
- Compatible with popular interface standards:
 - TIA/EIA-485 and TIA/EIA-422-A
 - CCITT recommendation V.11
- Bi-directional transceiver
 - Designed for multipoint transmission
- Wide bus common mode range
 - (-7V to +12V)
- Available in plastic DIP and SOIC packages

Connection and Logic Diagram

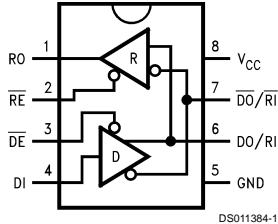

DS011384-1

Order Number DS36277TM or DS36277TN
See NS Package Number M08A or N08E

Truth Tables

Driver

Inputs		Outputs	
\overline{DE}	DI	DO/RI	$\overline{DO}/\overline{RI}$
L	L	L	H
L	H	H	L
H	X	Z	Z

Receiver

Inputs	Output
\overline{RE}	RO
L	≥ 0 mV
L	≤ -500 mV
L	SHORTED
L	OPEN
H	X

Absolute Maximum Ratings (Note 1)

If Military/Aerospace specified devices are required, please contact the National Semiconductor Sales Office/Distributors for availability and specifications.

Supply Voltage (V_{CC})	7V
Input Voltage (\overline{DE} , \overline{RE} , and DI)	5.5V
Driver Output Voltage/	
Receiver Input Voltage	-10V to +15V
Receiver Output Voltage (RO)	5.5V
Maximum Package Power Dissipation @ +25°C	
N Package (derate 9.3 mW/°C above +25°C)	1168 mW
M Package (derate 5.8 mW/°C above +25°C)	726 mW

Storage Temperature Range	-65°C to +150°C
Lead Temperature (Soldering 4 sec.)	260°C
ESD Rating (HBM, 1.5 kΩ, 100 pF)	≥ 6.0 kV

Recommended Operating Conditions

	Min	Max	Units
Supply Voltage, V_{CC}	4.75	5.25	V
Bus Voltage	-7	+12	V
Operating Temperature (T_A)			
DS36277T	-40	+85	°C

Electrical Characteristics (Notes 2, 4)

Over recommended Supply Voltage and Operating Temperature ranges, unless otherwise specified.

Symbol	Parameter	Conditions	Min	Typ	Max	Units		
DRIVER CHARACTERISTICS								
V_{OD}	Differential Output Voltage	$I_O = 0$ mA (No Load)	1.5	3.6	6	V		
V_{oDO}	Output Voltage	$I_O = 0$ mA (Output to GND)	0		6	V		
$V_{\overline{oDO}}$	Output Voltage		0		6	V		
V_{T1}	Differential Output Voltage (Termination Load)	$R_L = 54\Omega$ (485)	(Figure 1)		1.3	2.2	5.0	V
		$R_L = 100\Omega$ (422)	1.7	2.6	5.0	V		
ΔV_{T1}	Balance of V_{T1} $ V_{T1} - \overline{V_{T1}} $	$R_L = 54\Omega$	(Note 3)		-0.2		0.2	V
		$R_L = 100\Omega$	-0.2		0.2	V		
V_{OS}	Driver Common Mode Output Voltage	$R_L = 54\Omega$	(Figure 1)		0	2.5	3.0	V
		$R_L = 100\Omega$	0	2.5	3.0	V		
ΔV_{OS}	Balance of V_{OS} $ V_{OS} - \overline{V_{OS}} $	$R_L = 54\Omega$	(Note 3)		-0.2		0.2	V
		$R_L = 100\Omega$	-0.2		0.2	V		
V_{OH}	Output Voltage High	$I_{OH} = -22$ mA	(Figure 2)		2.7	3.7	V	
V_{OL}	Output Voltage Low	$I_{OL} = +22$ mA		1.3	2	V		
I_{OSD}	Driver Short-Circuit Output Current	$V_O = +12$ V	(Figure 3)			92	290	mA
		$V_O = -7$ V		-187	-290	mA		
RECEIVER CHARACTERISTICS								
V_{TH}	Differential Input High Threshold Voltage (Note 5)	$V_O = V_{OH}$, $I_O = -0.4$ mA $-7V \leq V_{CM} \leq +12V$		-0.150	0	V		
V_{TL}	Differential Input Low Threshold Voltage (Note 5)	$V_O = V_{OL}$, $I_O = 8.0$ mA $-7V \leq V_{CM} \leq +12V$	-0.5	-0.230		V		
V_{HST}	Hysteresis (Note 6)	$V_{CM} = 0$ V		80		mV		
I_{IN}	Line Input Current ($V_{CC} = 4.75$ V, 5.25 V, 0 V)	Other Input = 0 V	$V_1 = +12$ V $V_1 = -7$ V		0.5	1.5	mA	
		$\overline{DE} = V_{IH}$ (Note 7)		-0.5	-1.5	mA		
I_{OSR}	Short Circuit Current	$V_O = 0$ V	RO	-15	-32	-85	mA	
I_{OZ}	TRI-STATE® Leakage Current	$V_O = 0.4$ to 2.4 V		-20	1.4	+20	μA	
V_{OH}	Output High Voltage (Figure 12)	$V_{ID} = 0$ V, $I_{OH} = -0.4$ mA		2.3	3.7		V	
		$V_{ID} = OPEN$, $I_{OH} = -0.4$ mA		2.3	3.7		V	
V_{OL}	Output Low Voltage (Figure 12)	$V_{ID} = -0.5$ V, $I_{OL} = +8$ mA			0.3	0.7	V	
		$V_{ID} = -0.5$ V, $I_{OL} = +16$ mA			0.3	0.8	V	
R_{IN}	Input Resistance		10	20		kΩ		

Electrical Characteristics (Notes 2, 4) (Continued)

Over recommended Supply Voltage and Operating Temperature ranges, unless otherwise specified.

Symbol	Parameter	Conditions	Min	Typ	Max	Units	
DEVICE CHARACTERISTICS							
V _{IH}	High Level Input Voltage		2.0		V _{CC}	V	
V _{IL}	Low Level Input Voltage						
I _{IH}	High Level Input Current						V _{IH} = 2.4V
I _{IL}	Low Level Input Current						V _{IL} = 0.4V
V _{CL}	Input Clamp Voltage	I _{CL} = -18 mA		-0.7	-1.5	V	
I _{CC}	Output Low Voltage	$\overline{DE} = 0V, \overline{RE} = 0V, DI = 0V$		39	60	mA	
I _{CCR}	Supply Current	$\overline{DE} = 3V, \overline{RE} = 0V, DI = 0V$		24	50	mA	
I _{CCD}	(No Load)	$\overline{DE} = 0V, \overline{RE} = 3V, DI = 0V$		40	75	mA	
I _{CCX}		$\overline{DE} = 3V, \overline{RE} = 3V, DI = 0V$		27	45	mA	

Switching Characteristics (Note 4)

Over recommended Supply Voltage and Operating Temperature ranges, unless otherwise specified.

Symbol	Parameter	Conditions	Min	Typ	Max	Units
DRIVER CHARACTERISTICS						
t _{PLHD}	Diff. Prop. Delay Low to High	R _L = 54Ω	8	17	60	ns
t _{PHLD}	Diff. Prop. Delay High to Low	C _L = 50 pF	8	19	60	ns
t _{SKD}	Diff. Skew (t _{PLHD} - t _{PHLD})	C _D = 50 pF		2	10	ns
t _r	Diff. Rise Time	(Figures 4, 5)		11	60	ns
t _f	Diff. Fall Time			11	60	ns
t _{PLH}	Prop. Delay Low to High	R _L = 27Ω, C _L = 15 pF		22	85	ns
t _{PHL}	Prop. Delay High to Low	(Figures 6, 7)		25	85	ns
t _{PZH}	Enable Time Z to High	R _L = 110Ω		25	60	ns
t _{PZL}	Enable Time Z to Low	C _L = 50 pF		30	60	ns
t _{PHZ}	Disable Time High to Z	(Figure 8 - Figure 11)		16	60	ns
t _{PLZ}	Disable Time Low to Z			11	60	ns
RECEIVER CHARACTERISTICS						
t _{PLH}	Prop. Delay Low to High	V _{ID} = -1.5V to +1.5V	15	37	90	ns
t _{PHL}	Prop. Delay High to Low	C _L = 15 pF	15	43	90	ns
t _{SK}	Skew (t _{PLH} - t _{PHL})	(Figures 13, 14)		6	15	ns
t _{PZH}	Enable Time Z to High	C _L = 15 pF		12	60	ns
t _{PZL}	Enable Time Z to Low	(Figures 15, 16)		28	60	ns
t _{PHZ}	Disable Time High to Z			20	60	ns
t _{PLZ}	Disable Time Low to Z			10	60	ns

Note 1: "Absolute Maximum Ratings" are those values beyond which the safety of the device cannot be guaranteed. They are not meant to imply that the devices should be operated at these limits. The tables of "Electrical Characteristics" specify conditions for device operation.

Note 2: Current into device pins is defined as positive. Current out of device pins is defined as negative. All voltages are referenced to ground unless otherwise specified.

Note 3: $\Delta |V_{T1}|$ and $\Delta |V_{OS}|$ are changes in magnitude of V_{T1} and V_{OS} , respectively, that occur when the input changes state.

Note 4: All typicals are given for $V_{CC} = 5.0V$ and $T_A = +25^\circ C$.

Note 5: Threshold parameter limits specified as an algebraic value rather than by magnitude.

Note 6: Hysteresis defined as $V_{HST} = V_{TH} - V_{TL}$.

Note 7: I_{IN} includes the receiver input current and driver TRI-STATE leakage current.

Parameter Measurement Information

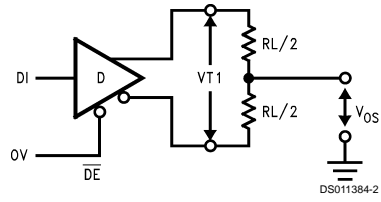

FIGURE 1. Driver V_{T1} and V_{OS} Test Circuit

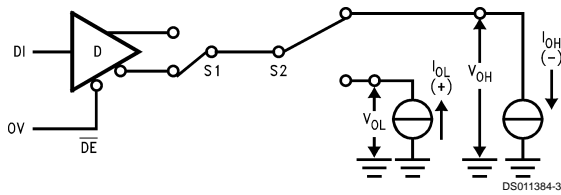

FIGURE 2. Driver V_{OH} and V_{OL} Test Circuit

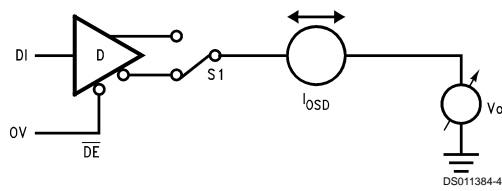

FIGURE 3. Driver Short Circuit Test Circuit

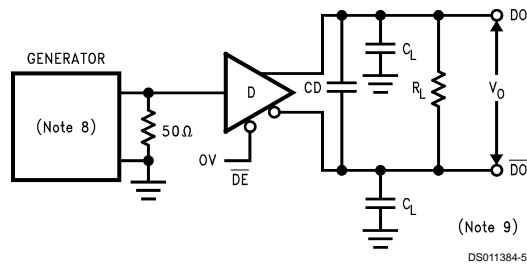

FIGURE 4. Driver Differential Propagation Delay and Transition Time Test Circuit

Parameter Measurement Information (Continued)

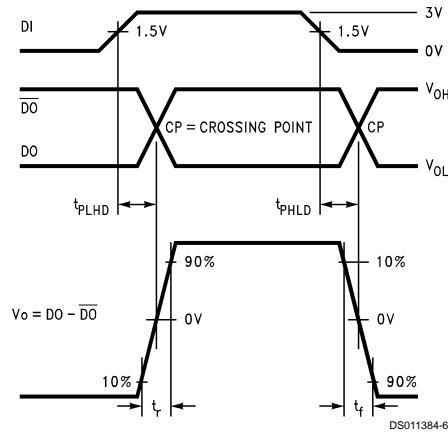

FIGURE 5. Driver Differential Propagation Delays and Transition Times

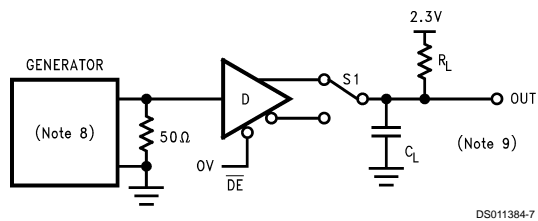

FIGURE 6. Driver Propagation Delay Test Circuit

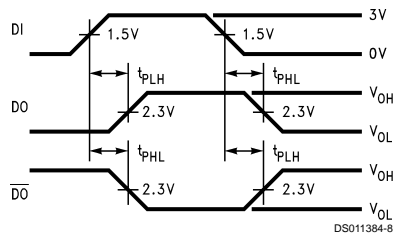
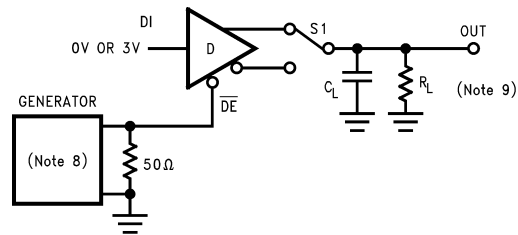

FIGURE 7. Driver Propagation Delays



S1 to DO for DI = 3V
 S1 to \overline{DO} for DI = 0V

FIGURE 8. Driver TRI-STATE Test Circuit (t_{PZH} , t_{PHZ})

Parameter Measurement Information (Continued)

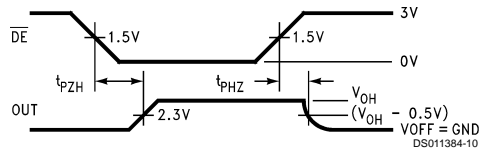
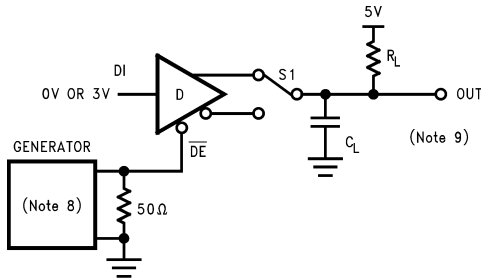

FIGURE 9. Driver TRI-STATE Delays (t_{PZH} , t_{PHZ})



DS011384-11

S1 to \overline{DO} for DI = 0V
S1 to \overline{DO} for DI = 3V

FIGURE 10. Driver TRI-STATE Test Circuit (t_{PZL} , t_{PLZ})

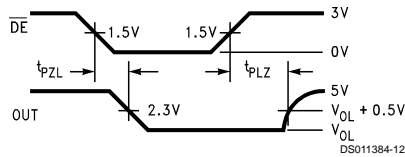

FIGURE 11. Driver TRI-STATE Delays (t_{PZL} , t_{PLZ})

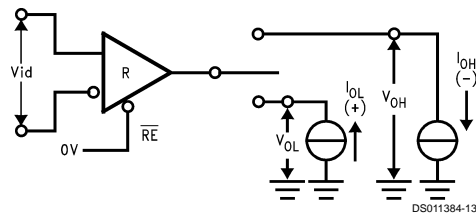
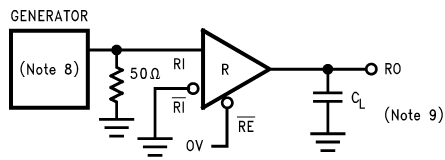

FIGURE 12. Receiver V_{OH} and V_{OL}



DS011384-14

FIGURE 13. Receiver Propagation Delay Test Circuit

Parameter Measurement Information (Continued)

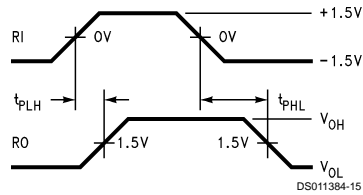

FIGURE 14. Receiver Propagation Delays

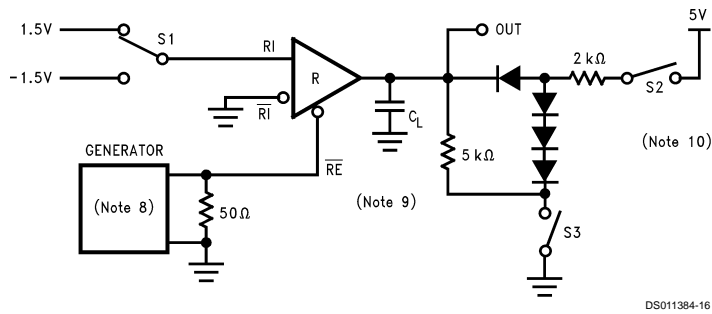

FIGURE 15. Receiver TRI-STATE Delay Test Circuit

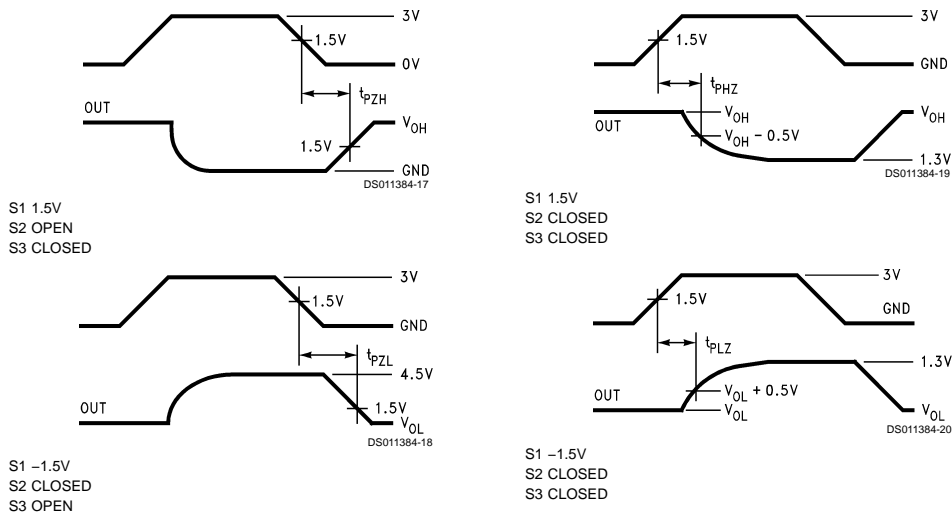

FIGURE 16. Receiver Enable and Disable Timing

Note 8: The input pulse is supplied by a generator having the following characteristics: $f = 1.0$ MHz, 50% duty cycle, t_r and $t_f < 6.0$ ns, $Z_0 = 50\Omega$.

Note 9: C_L includes probe and stray capacitance.

Note 10: Diodes are 1N916 or equivalent.

Typical Performance Characteristics

Differential Output Voltage vs Output Current

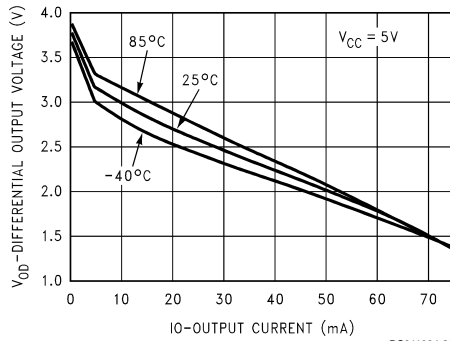

Differential Output Voltage vs Output Current

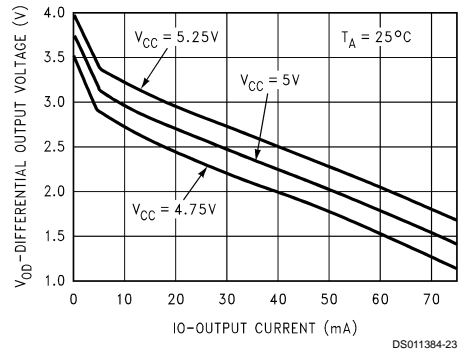

Driver V_{OH} vs I_{OH} vs V_{CC}

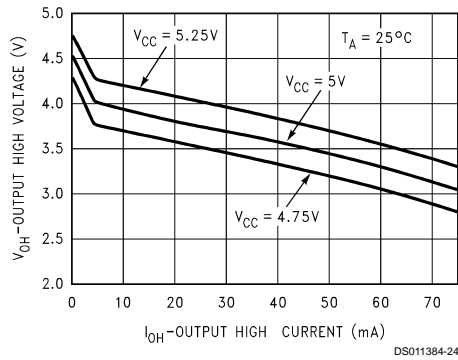

Driver V_{OH} vs I_{OH} vs Temperature

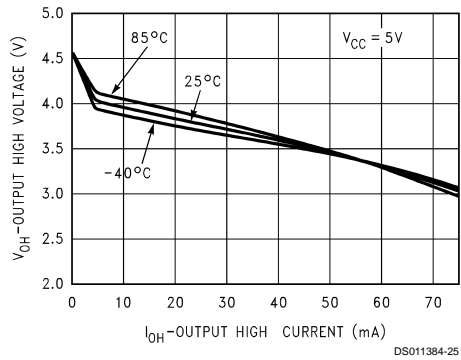

Driver V_{OL} vs I_{OL} vs V_{CC}

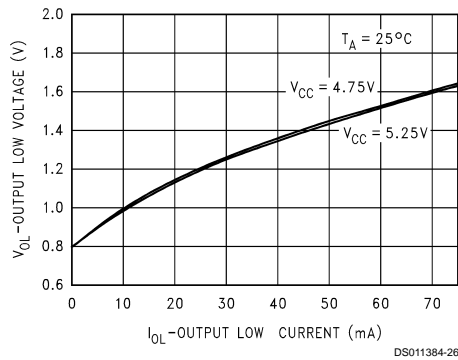

Driver V_{OL} vs I_{OL} vs Temperature

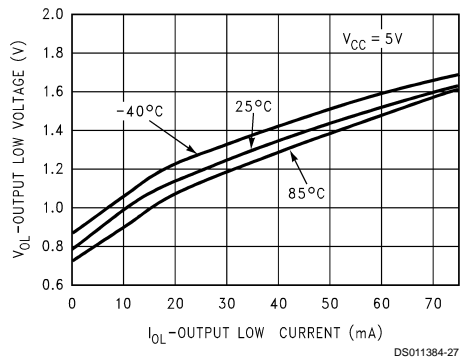

Typical Performance Characteristics (Continued)

Receiver V_{OH} vs I_{OH} vs V_{CC}

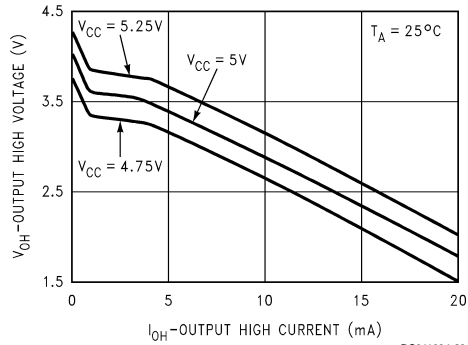

DS011384-28

Receiver V_{OH} vs I_{OH} vs Temperature

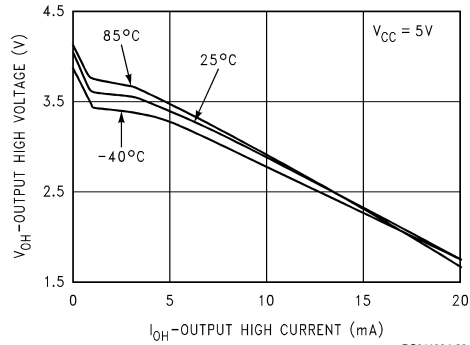

DS011384-29

Receiver V_{OL} vs I_{OL} vs V_{CC}

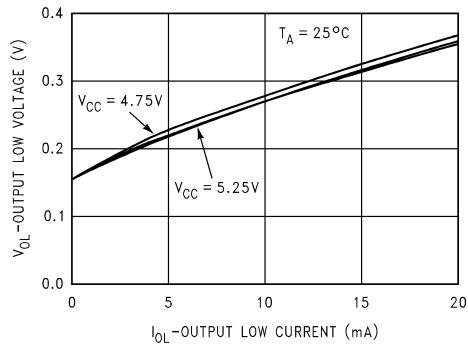

DS011384-30

Receiver V_{OL} vs I_{OL} vs Temperature

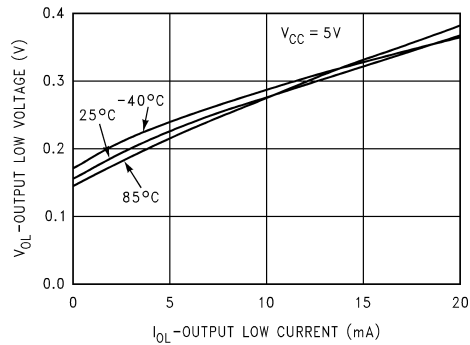

DS011384-31

Supply Current vs Supply Voltage

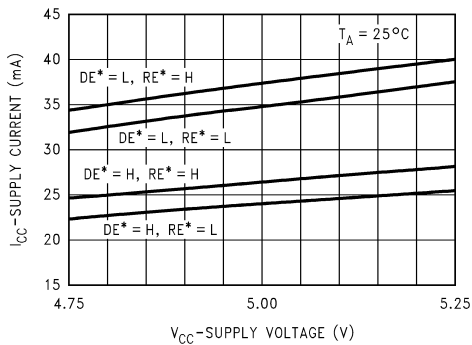

DS011384-32

Supply Current vs Temperature

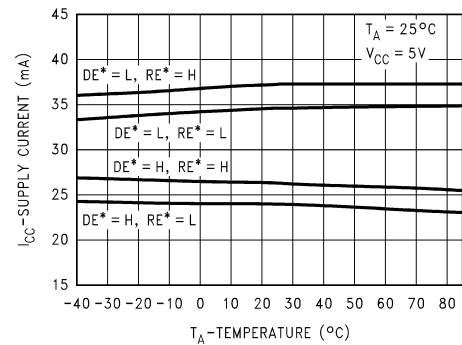

DS011384-33

Typical Performance Characteristics (Continued)

Voltage Output vs Voltage Input (Hysteresis)

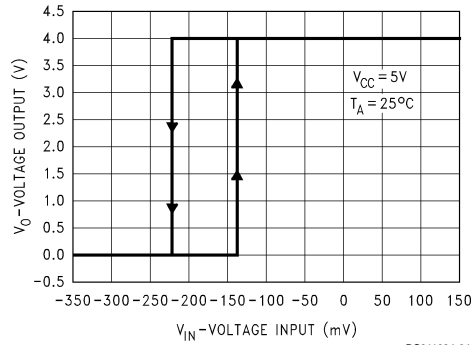

DS011384-34

Typical Applications Information

SAE J1708 Node with External Bias Resistors and Filters

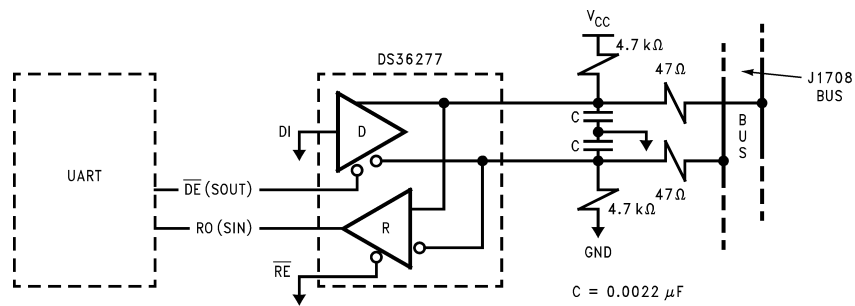

DS011384-21

Physical Dimensions inches (millimeters) unless otherwise noted

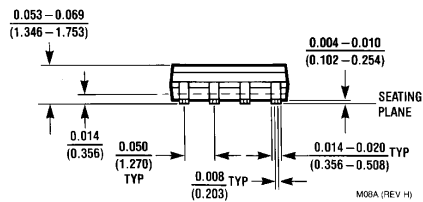
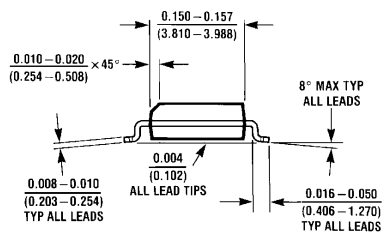
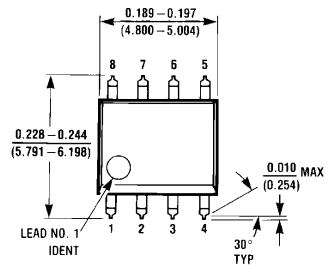

8-Lead Molded Package (SO)
Order Number DS36277TM
NS Package Number M08A

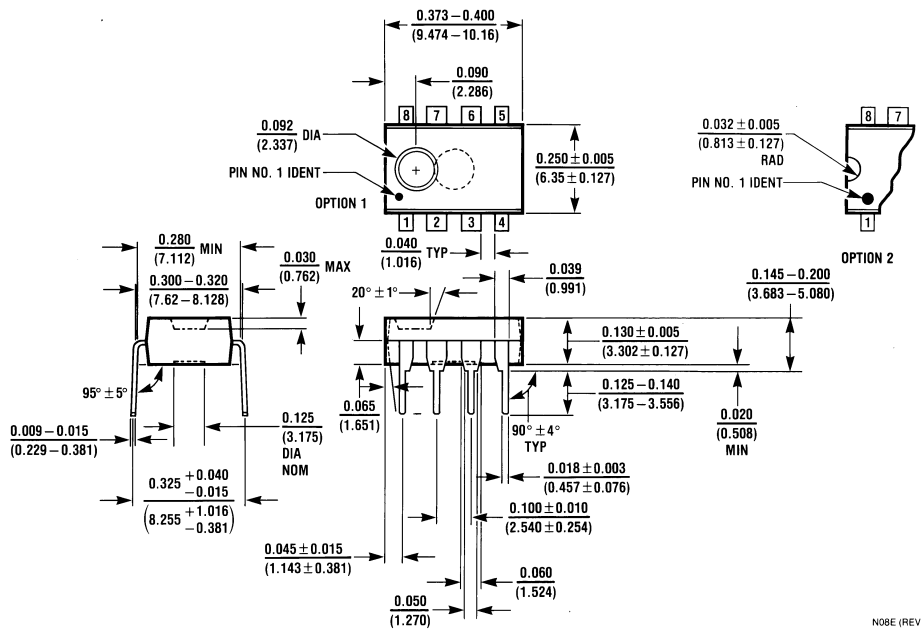

8-Lead Molded Dual-In-Line Package (N)
Order Number DS36277TN
NS Package Number N08E

LIFE SUPPORT POLICY

NATIONAL'S PRODUCTS ARE NOT AUTHORIZED FOR USE AS CRITICAL COMPONENTS IN LIFE SUPPORT DEVICES OR SYSTEMS WITHOUT THE EXPRESS WRITTEN APPROVAL OF THE PRESIDENT OF NATIONAL SEMICONDUCTOR CORPORATION. As used herein:

1. Life support devices or systems are devices or systems which, (a) are intended for surgical implant into the body, or (b) support or sustain life, and whose failure to perform when properly used in accordance with instructions for use provided in the labeling, can be reasonably expected to result in a significant injury to the user.
2. A critical component is any component of a life support device or system whose failure to perform can be reasonably expected to cause the failure of the life support device or system, or to affect its safety or effectiveness.



National Semiconductor Corporation
Americas
Tel: 1-800-272-9959
Fax: 1-800-737-7018
Email: support@nsc.com

www.national.com

National Semiconductor Europe
Fax: +49 (0) 1 80-530 85 86
Email: europe.support@nsc.com
Deutsch Tel: +49 (0) 1 80-530 85 85
English Tel: +49 (0) 1 80-532 78 32
Français Tel: +49 (0) 1 80-532 93 58
Italiano Tel: +49 (0) 1 80-534 16 80

National Semiconductor Asia Pacific Customer Response Group
Tel: 65-2544466
Fax: 65-2504466
Email: sea.support@nsc.com

National Semiconductor Japan Ltd.
Tel: 81-3-5639-7560
Fax: 81-3-5639-7507