

Cascadable Silicon Bipolar MMIC Amplifier

Technical Data

MSA-0686

Features

- **Cascadable 50 Ω Gain Block**
- **Low Operating Voltage:**
3.5 V Typical V_d
- **3 dB Bandwidth:**
DC to 0.8 GHz
- **High Gain:**
18.5 dB Typical at 0.5 GHz
- **Low Noise Figure:**
3.0 dB Typical at 0.5 GHz
- **Surface Mount Plastic Package**
- **Tape-and-Reel Packaging Available^[1]**

Note:

1. Refer to PACKAGING section "Tape-and-Reel Packaging for Surface Mount Semiconductors".

Description

The MSA-0686 is a high performance silicon bipolar Monolithic Microwave Integrated Circuit (MMIC) housed in a low cost, surface mount plastic package. This MMIC is designed for use as a general purpose 50 Ω gain block. Applications include narrow and broad band IF and RF amplifiers in commercial and industrial applications.

The MSA-series is fabricated using HP's 10 GHz f_T , 25 GHz f_{MAX} , silicon bipolar MMIC process which uses nitride self-alignment, ion implantation, and gold metallization to achieve excellent performance, uniformity and reliability. The use of an external bias resistor for temperature and current stability also allows bias flexibility.

86 Plastic Package

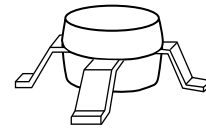

Typical Biasing Configuration

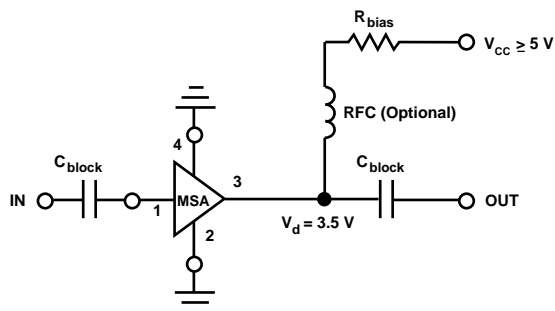

MSA-0686 Absolute Maximum Ratings

Parameter	Absolute Maximum ^[1]
Device Current	50 mA
Power Dissipation ^[2,3]	200 mW
RF Input Power	+13 dBm
Junction Temperature	150°C
Storage Temperature	-65 to 150°C

Thermal Resistance^{[2,4]:}

$$\theta_{jc} = 120^{\circ}\text{C/W}$$

Notes:

1. Permanent damage may occur if any of these limits are exceeded.
2. $T_{\text{CASE}} = 25^{\circ}\text{C}$.
3. Derate at $8.3 \text{ mW}/^{\circ}\text{C}$ for $T_{\text{C}} > 126^{\circ}\text{C}$.
4. See MEASUREMENTS section “Thermal Resistance” for more information.

Electrical Specifications^[1], $T_{\text{A}} = 25^{\circ}\text{C}$

Symbol	Parameters and Test Conditions: $I_{\text{d}} = 16 \text{ mA}$, $Z_{\text{o}} = 50 \Omega$	Units	Min.	Typ.	Max.
G _P	Power Gain ($ S_{21} ^2$)	dB	16.5	20.0	
				18.5	
ΔG_{P}	Gain Flatness	dB		± 0.7	
f _{3 dB}	3 dB Bandwidth	GHz		0.8	
VSWR	Input VSWR			1.7:1	
	Output VSWR			1.7:1	
NF	50 Ω Noise Figure	dB		3.0	
P _{1 dB}	Output Power at 1 dB Gain Compression	dBm		2.0	
IP ₃	Third Order Intercept Point	dBm		14.5	
t _D	Group Delay	psec		225	
V _d	Device Voltage	V	2.8	3.5	4.2
dV/dT	Device Voltage Temperature Coefficient	mV/°C		-8.0	

Notes:

1. The recommended operating current range for this device is 12 to 20 mA. Typical performance as a function of current is on the following page.

Part Number Ordering Information

Part Number	No. of Devices	Container
MSA-0686-TR1	1000	7" Reel
MSA-0686-BLK	100	Antistatic Bag

For more information, see “Tape and Reel Packaging for Semiconductor Devices”.

MSA-0686 Typical Scattering Parameters ($Z_0 = 50 \Omega$, $T_A = 25^\circ\text{C}$, $I_d = 16 \text{ mA}$)

Freq. GHz	S_{11}		S_{21}			S_{12}			S_{22}		k
	Mag	Ang	dB	Mag	Ang	dB	Mag	Ang	Mag	Ang	
0.1	.06	-175	20.1	10.08	170	-23.3	.069	4	.04	-84	1.05
0.2	.06	-169	19.8	9.77	161	-23.2	.069	8	.07	-103	1.05
0.3	.07	-164	19.4	9.35	152	-22.5	.075	13	.10	-113	1.03
0.4	.08	-158	19.1	8.98	144	-22.2	.078	16	.13	-123	1.02
0.5	.08	-154	18.7	8.58	135	-21.6	.083	18	.15	-131	1.01
0.6	.09	-152	18.0	7.94	128	-21.1	.088	21	.18	-140	1.01
0.8	.12	-152	17.2	7.25	114	-20.3	.097	25	.21	-155	1.00
1.0	.15	-154	16.3	6.51	102	-19.5	.106	25	.24	-168	0.99
1.5	.25	-171	14.0	5.01	76	-17.6	.133	22	.27	165	0.99
2.0	.34	171	11.9	3.94	56	-16.1	.157	19	.27	147	1.01
2.5	.43	155	9.8	3.09	42	-15.9	.161	16	.27	134	1.06
3.0	.49	140	8.0	2.51	28	-15.3	.171	11	.26	124	1.10
3.5	.56	128	6.4	2.09	15	-15.1	.175	6	.25	118	1.13
4.0	.61	118	5.0	1.78	3	-14.9	.180	3	.24	115	1.15
5.0	.70	99	2.4	1.32	-18	-14.7	.185	-2	.24	118	1.16

Note:

1. A model for this device is available in the DEVICE MODELS section.

Typical Performance, $T_A = 25^\circ\text{C}$

(unless otherwise noted)

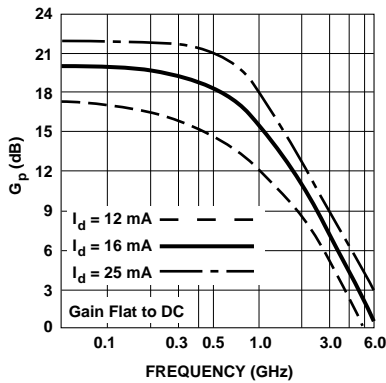

Figure 1. Typical Power Gain vs. Frequency, $T_A = 25^\circ\text{C}$.

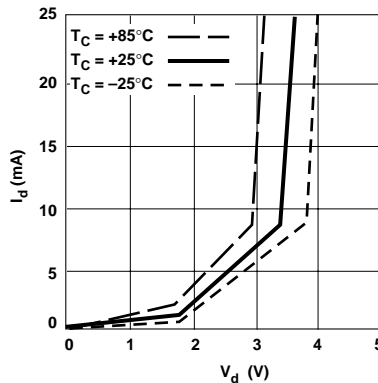

Figure 2. Device Current vs. Voltage.

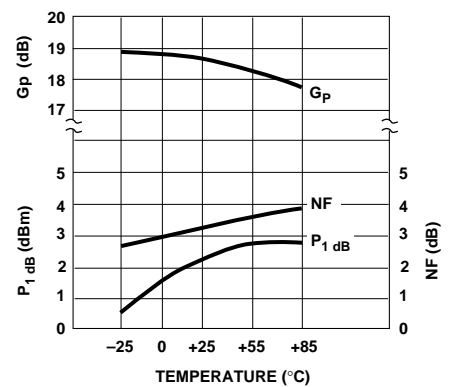

Figure 3. Output Power at 1 dB Gain Compression, NF and Power Gain vs. Case Temperature, $f = 1.0 \text{ GHz}$, $I_d = 16 \text{ mA}$.

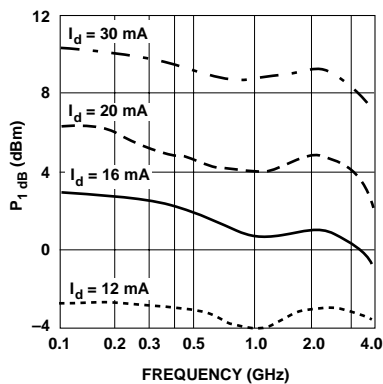

Figure 4. Output Power at 1 dB Gain Compression vs. Frequency.

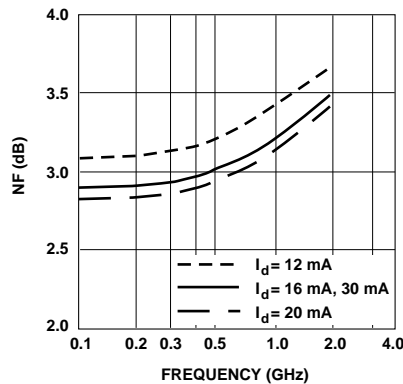
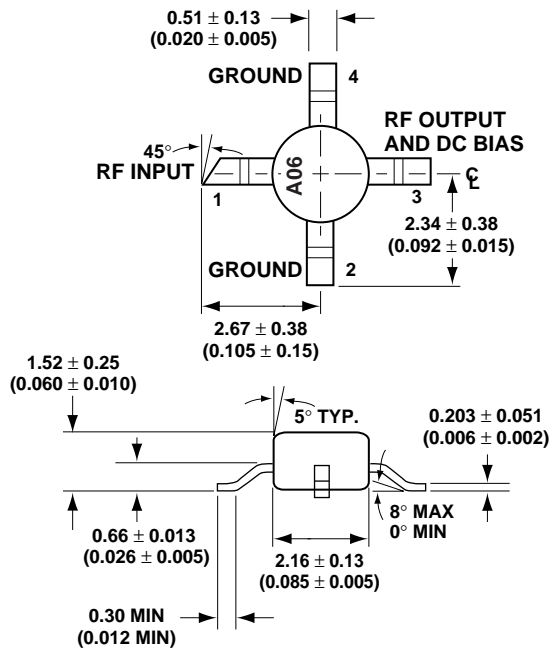

Figure 5. Noise Figure vs. Frequency.

86 Plastic Package Dimensions



DIMENSIONS ARE IN MILLIMETERS (INCHES)