

IN74LV244

OCTAL BUFFER/LINE DRIVER 3-STATE

The IN74LV244 is a low-voltage Si-gate CMOS device and is pin and function compatible with IN74HC/HCT244.

The IN74LV244 is an octal non-inverting buffer/line driver with 3-state outputs. The 3-state outputs are controlled by the output enable inputs $\overline{1OE}$ and $\overline{2OE}$. A HIGH on \overline{nOE} causes the outputs to assume a high impedance OFF-state.

The IN74LV244 is identical to the IN74LV240 but has non-inverting outputs.

- Outputs Directly Interface to CMOS, NMOS, and TTL
- Operating Voltage Range: 1.2 to 3.6 V
- Low Input Current: 1.0 μ A, 0.1 μ A at T = 25 °C
- Output Current: 8 mA at $V_{CC} = 3.0$ V
- High Noise Immunity Characteristic of CMOS Devices

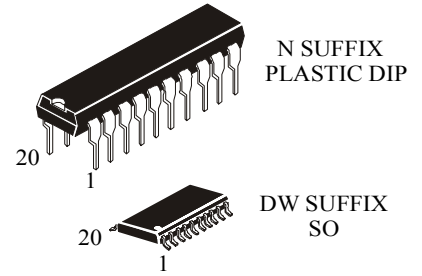

ORDERING INFORMATION

IN74LV244N Plastic DIP
IN74LV244DW SOIC
IZ74LV244 chip
 $T_A = -40^\circ$ to 125° C for all packages

LOGIC DIAGRAM

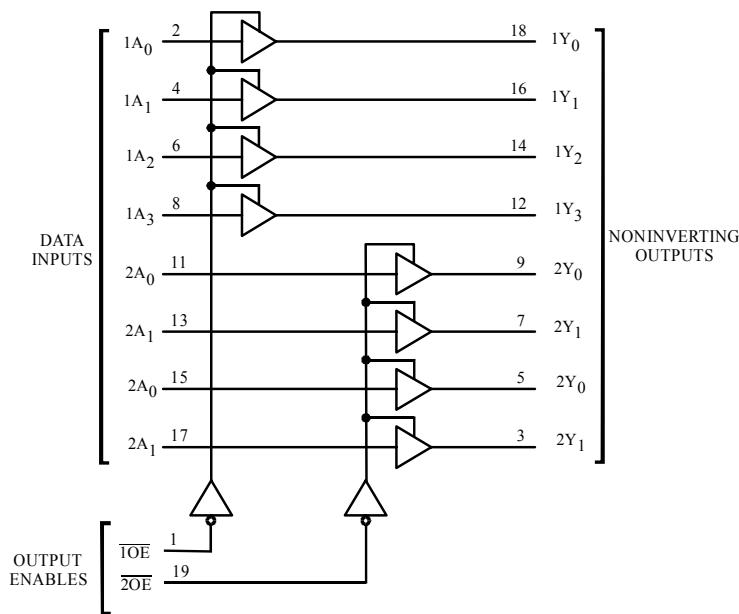

PIN 20 = V_{CC}
 PIN 10 = GND

PIN ASSIGNMENT

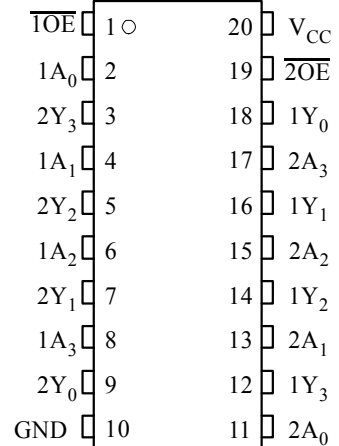

FUNCTION TABLE

Input		OUTPUT
\overline{nOE}	nAn	nYn
L	L	L
L	H	H
H	X	Z

H= high level
 L = low level
 X = don't care
 Z = high impedance

IN74LV244

MAXIMUM RATINGS*

Symbol	Parameter	Value	Unit
V_{CC}	DC supply voltage	-0.5 to +5.0	V
I_{IK}^{*1}	DC Input diode current	± 20	mA
I_{OK}^{*2}	DC Output diode current	± 50	mA
I_O^{*3}	DC Output source or sink current	± 35	mA
I_{CC}	DC V_{CC} current	± 70	mA
I_{GND}	DC GND current	± 70	mA
P_D	Power dissipation per package: ^{*4} Plastic DIP SO	750 500	mW
T_{stg}	Storage Temperature	-65 to +150	°C
T_L	Lead Temperature, 1.5 mm (Plastic DIP Package), 0.3 mm (SO Package) from Case for 4 Seconds	260	°C

*Maximum Ratings are those values beyond which damage to the device may occur. Functional operation should be restricted to the Recommended Operating Conditions.

*¹ $V_I < -0.5\text{ V}$ or $V_I > V_{CC} + 0.5\text{ V}$.

*² $V_O < -0.5\text{ V}$ or $V_O > V_{CC} + 0.5\text{ V}$.

*³ $-0.5\text{ V} < V_O < V_{CC} + 0.5\text{ V}$.

*⁴ Derating - Plastic DIP: - 12 mW/°C from 70° to 125°C

SO Package: : - 8 mW/°C from 70° to 125°C

RECOMMENDED OPERATING CONDITIONS

Symbol	Parameter	Min	Max	Unit
V_{CC}	DC Supply Voltage	1.2	3.6	V
V_I	Input Voltage	0	V_{CC}	V
V_O	Output Voltage	0	V_{CC}	V
T_A	Operating Temperature, All Package Types	-40	+125	°C
t_r, t_f	Input Rise and Fall Time (Figure 1)			
	$V_{CC} = 1.2\text{ V}$	0	1000	ns
	$V_{CC} = 2.0\text{ V}$	0	700	
	$V_{CC} = 3.0\text{ V}$	0	500	
	$V_{CC} = 3.6\text{ V}$	0	400	

This device contains protection circuitry to guard against damage due to high static voltages or electric fields. However, precautions must be taken to avoid applications of any voltage higher than maximum rated voltages to this high-impedance circuit. For proper operation, V_{IN} and V_{OUT} should be constrained to the range $GND \leq (V_{IN} \text{ or } V_{OUT}) \leq V_{CC}$.

Unused inputs must always be tied to an appropriate logic voltage level (e.g., either GND or V_{CC}). Unused outputs must be left open.

IN74LV244

DC ELECTRICAL CHARACTERISTICS (Voltages Referenced to GND)

Symbol	Parameter	Test conditions	V _{CC} V	Guaranteed Limit						Unit
				25°C		-40°C to 85°C		125°C		
				min	max	min	max	min	max	
V _{IH}	HIGH level input voltage		1.2	0.9	-	0.9	-	0.9	-	V
			2.0	1.4	-	1.4	-	1.4	-	
			3.0	2.1	-	2.1	-	2.1	-	
			3.6	2.5	-	2.5	-	2.5	-	
V _{IL}	LOW level input voltage		1.2	-	0.3	-	0.3	-	0.3	V
			2.0	-	0.6	-	0.6	-	0.6	
			3.0	-	0.9	-	0.9	-	0.9	
			3.6	-	1.1	-	1.1	-	1.1	
V _{OH}	HIGH level output voltage	V _I = V _{IH} or V _{IL} I _O = -50 μA	1.2	1.1	-	1.0	-	1.0	-	V
			2.0	1.92	-	1.9	-	1.9	-	
			3.0	2.92	-	2.9	-	2.9	-	
			3.6	3.52	-	3.5	-	3.5	-	
		3.0	2.48	-	2.34	-	2.20	-	V	
V _{OL}	LOW level output voltage	V _I = V _{IH} or V _{IL} I _O = 50 μA	1.2	-	0.09	-	0.1	-	0.1	V
			2.0	-	0.09	-	0.1	-	0.1	
			3.0	-	0.09	-	0.1	-	0.1	
			3.6	-	0.09	-	0.1	-	0.1	
		3.0	-	0.33	-	0.4	-	0.5	V	
I _I	Input current	V _I = V _{CC} or 0 V	*	-	±0.1	-	±1.0	-	±1.0	μA
I _{OZ}	Three state leakage current	3-state outputs V _I (01,19) = V _{IH} V _O = V _{CC} or 0 V	1.2 *	-	±0.5	-	±5	-	±10	μA
I _{CC}	Supply current	V _I = V _{CC} or 0 V I _O = 0 μA	*	-	8.0	-	80	-	160	μA

* V_{CC} = 3.3 ± 0.3 V

IN74LV244

AC ELECTRICAL CHARACTERISTICS ($C_L=50$ pF, $t_r=t_f=6.0$ ns)

Symbol	Parameter	Test conditions	V_{CC} V	Guaranteed Limit						Unit
				25°C		-40°C to 85°C		125°C		
				min	max	min	max	min	max	
t_{PHL}, t_{PLH}	Propagation delay, $1A_n$ to $1Y_n$, $2A_n$ to $2Y_n$	$V_I = 0$ V or V_{CC} Figure 1 and 3	1.2 2.0 *	- 100 -	100 24 15	- - -	125 30 19	- - -	150 36 23	ns
t_{PHZ}, t_{PLZ}	Propagation delay, $\overline{1OE}$ to $1Y_n$, $\overline{2OE}$ to $2Y_n$	$V_I = 0$ V or V_{CC} Figure 2 and 4	1.2 2.0 *	- 140 -	140 30 20	- - -	175 35 24	- - -	210 41 28	ns
t_{PZH}, t_{PZL}	Propagation delay, $\overline{1OE}$ to $1Y_n$, $\overline{2OE}$ to $2Y_n$	$V_I = 0$ V or V_{CC} Figure 2 and 4	1.2 2.0 *	- 140 -	140 32 20	- - -	175 40 25	- - -	210 48 30	ns
t_{THL}, t_{TLH}	Output Transition Time, Any Output	$V_I = 0$ V or V_{CC} Figure 1 and 3	1.2 2.0 *	- 60 -	60 16 10	- - -	75 20 13	- - -	90 24 15	ns
C_I	Input capacitance		3.0	-	7.0	-	7.0	-	7.0	pF
C_{PD}	Power dissipation capacitance (per one channel)	$V_I = 0$ V or V_{CC}		-	50	-	-	-	-	pF

* $V_{CC} = 3.3 \pm 0.3$ V

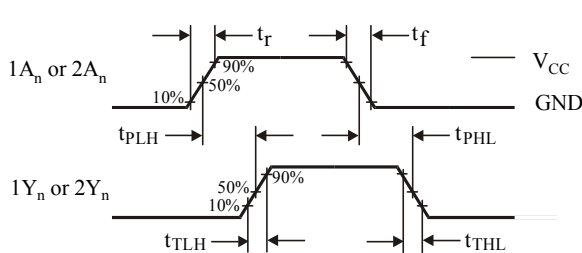

Figure 1. Switching Waveforms

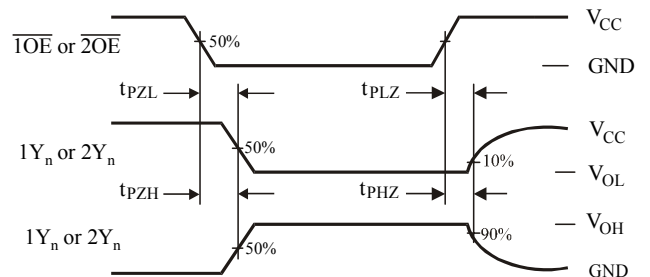
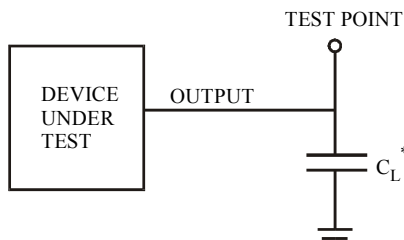
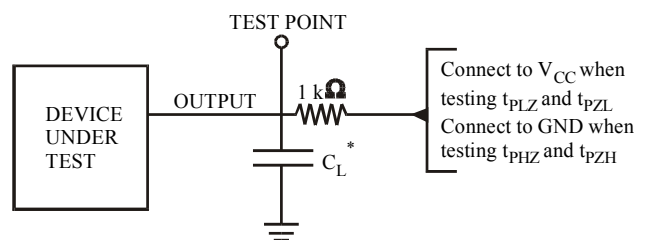

Figure 2. Switching Waveforms



* Includes all probe and jig capacitance
Figure 3. Test Circuit



* Includes all probe and jig capacitance
Figure 4. Test Circuit