

200MHz Amplifiers



The EL5150, EL5151, EL5250, EL5251, and EL5451 are 200MHz bandwidth -3dB voltage mode

feedback amplifiers with DC accuracy of 0.01%, 1mV offsets and 10kV/V open loop gains. These amplifiers are ideally suited for applications ranging from precision measurement instrumentation to high speed video and monitor applications. Capable of operating with as little as 1.4mA of current from a single supply ranging from 5V to 12V dual supplies ranging from $\pm 2.5V$ to $\pm 5.0V$, these amplifiers are also well suited for handheld, portable and battery-powered equipment.

Single amplifiers are offered in SOT-23 packages and duals in a 10-pin MSOP package for applications where board space is critical. Quad amplifiers are available in a 14-pin SO package. Additionally, singles and duals are available in the industry-standard 8-pin SO package. All parts operate over the industrial temperature range of $-40^{\circ}C$ to $+85^{\circ}C$.

Ordering Information

PART NUMBER	PACKAGE	TAPE & REEL	PKG. DWG. #
EL5150IS	8-Pin SO	-	MDP0027
EL5150IS-T7	8-Pin SO	7"	MDP0027
EL5150IS-T13	8-Pin SO	13"	MDP0027
EL5150IW-T7	6-Pin SOT-23	7" (3K pcs)	MDP0038
EL5150IW-T7A	6-Pin SOT-23	7" (250 pcs)	MDP0038
EL5151IW-T7	5-Pin SOT-23	7" (3K pcs)	MDP0038
EL5151IW-T7A	5-Pin SOT-23	7" (250 pcs)	MDP0038
EL5250IY	10-Pin MSOP	-	MDP0043
EL5250IY-T7	10-Pin MSOP	7"	MDP0043
EL5250IY-T13	10-Pin MSOP	13"	MDP0043
EL5251IS	8-Pin SO	-	MDP0027
EL5251IS-T7	8-Pin SO	7"	MDP0027
EL5251IS-T13	8-Pin SO	13"	MDP0027
EL5251IY	8-Pin MSOP	-	MDP0043
EL5251IY-T7	8-Pin MSOP	7"	MDP0043
EL5251IY-T13	8-Pin MSOP	13"	MDP0043
EL5451IS	14-Pin SO	-	MDP0027
EL5451IS-T7	14-Pin SO	7"	MDP0027
EL5451IS-T13	14-Pin SO	13"	MDP0027

Features

- 200MHz -3dB bandwidth
- 110V/ μs slew rate
- Very high open loop gains 50kV/V
- Low supply current = 1.4mA
- Single supplies from 5V to 12V
- Dual supplies from $\pm 2.5V$ to $\pm 5V$
- Fast disable on the EL5150 and EL5250
- Low cost

Applications

- Imaging
- Instrumentation
- Video
- Communications devices

Pinouts

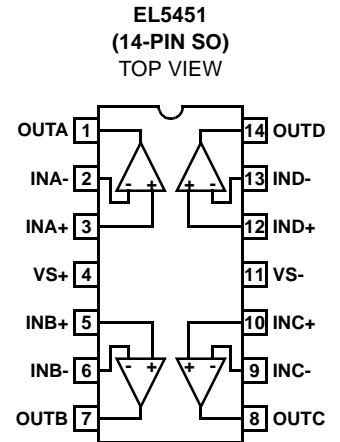
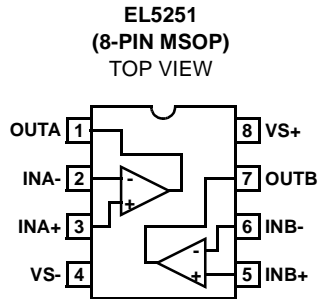
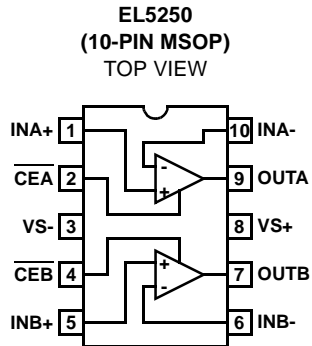
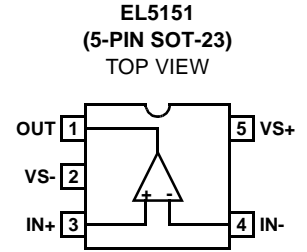
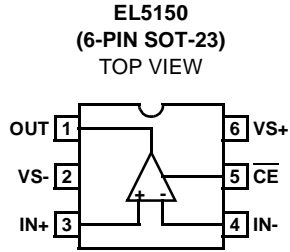
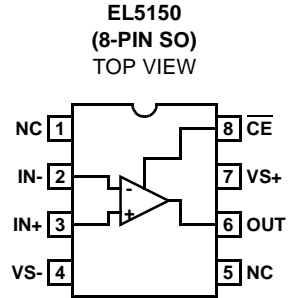

EL5150, EL5151, EL5250, EL5251, EL5451

Absolute Maximum Ratings (T_A = 25°C)

Supply Voltage between V _S and GND 12V	Junction Temperature -40°C to +125°C
Maximum Continuous Output Current 40mA	Storage Temperature -65°C to +150°C
Pin Voltages GND -0.5V to V _S +0.5V	Ambient Operating Temperature -40°C to +85°C
Power Dissipation See Curves	Current into I _{N+} , I _{N-} , CE 5mA

CAUTION: Stresses above those listed in "Absolute Maximum Ratings" may cause permanent damage to the device. This is a stress only rating and operation of the device at these or any other conditions above those indicated in the operational sections of this specification is not implied.

IMPORTANT NOTE: All parameters having Min/Max specifications are guaranteed. Typical values are for information purposes only. Unless otherwise noted, all tests are at the specified temperature and are pulsed tests, therefore: T_J = T_C = T_A

Electrical Specifications V_{S+} = +5V, V_{S-} = ±5V, R_L = 150Ω, T_A = 25°C, unless otherwise specified.

PARAMETER	DESCRIPTION	CONDITIONS	MIN	TYP	MAX	UNIT
AC PERFORMANCE						
BW	-3dB Bandwidth	A _V = +1, R _L = 500Ω		200		MHz
		A _V = +2, R _L = 150Ω		36		MHz
GBWP	Gain Bandwidth Product	A _V = 500		86		MHz
BW1	0.1dB Bandwidth	A _V = +1, R _L = 500Ω		10		MHz
SR	Slew Rate	V _O = ±2.5V, A _V = +2	50	67		V/μs
		V _O = ±3.0V, A _V = 1, R _L = 500Ω		100		V/μs
t _S	0.1% Settling Time	V _{OUT} = -1V to +1V, A _V = -2		80		ns
dG	Differential Gain Error (Note 1)	A _V = +2, R _L = 150Ω		0.1		%
dP	Differential Phase Error (Note 1)	A _V = +2, R _L = 150Ω		1.17		°
V _N	Input Referred Voltage Noise			12		nV/√Hz
I _N	Input Referred Current Noise			1.6		pA/√Hz
DC PERFORMANCE						
V _{OS}	Offset Voltage		-1	0.5	1	mV
T _C V _{OS}	Input Offset Voltage Temperature Coefficient	Measured from T _{MIN} to T _{MAX}		-2		μV/°C
A _{VOL}	Open Loop Gain		15	56		kV/V
INPUT CHARACTERISTICS						
CMIR	Common Mode Input Range	Guaranteed by CMRR test	TBD		TBD	V
CMRR	Common Mode Rejection Ratio		85	100		dB
I _B	Input Bias Current		-100	20	+100	mA
I _{OS}	Input Offset Current		-30	6	30	nA
R _{IN}	Input Resistance		80	170		MΩ
C _{IN}	Input Capacitance			1		pF
OUTPUT CHARACTERISTICS						
V _{OUT}	Output Voltage Swing Low	R _L = 150Ω to GND	±2.5	±2.8		V
		R _L = 500Ω to GND	±3.1	±3.4		V
I _{OUT}	Output Current	R _L = 10Ω to GND	±40	±70		mA
ENABLE (SELECTED PACKAGES ONLY)						
t _{EN}	Enable Time			170		ns
t _{DIS}	Disable Time			1.25		μs
I _{IHCE}	CE Pin Input High Current	CE = V _{S+}		0	-1	μA

Electrical Specifications $V_{S+} = +5V$, $V_{S-} = \pm 5V$, $R_L = 150\Omega$, $T_A = 25^\circ C$, unless otherwise specified. (Continued)

PARAMETER	DESCRIPTION	CONDITIONS	MIN	TYP	MAX	UNIT
I_{ILCE}	\overline{CE} Pin Input Low Current	$\overline{CE} = V_{S-}$	5	13	25	μA
V_{IHCE}	\overline{CE} Input High Voltage for Power-down		$V_{S+} - 1$			V
V_{ILCE}	\overline{CE} Input Low Voltage for Power-down				$V_{S+} - 3$	V
SUPPLY						
I_{SON}	Supply Current - Enabled (per amplifier)	No load, $V_{IN} = 0V$, $CE = +5V$	1.12	1.35	1.6	mA
I_{SOFF}	Supply Current - Disabled	No load, $V_{IN} = 0V$	5	13	25	μA
PSRR	Power Supply Rejection Ratio	DC, $V_S = \pm 3.0V$ to $\pm 6.0V$	80	110		dB

NOTE:

- Standard NTSC test, AC signal amplitude = $286mV_{P-P}$, $f = 3.58MHz$, V_{OUT} is swept from 0.8V to 3.4V, R_L is DC coupled

Typical Performance Curves

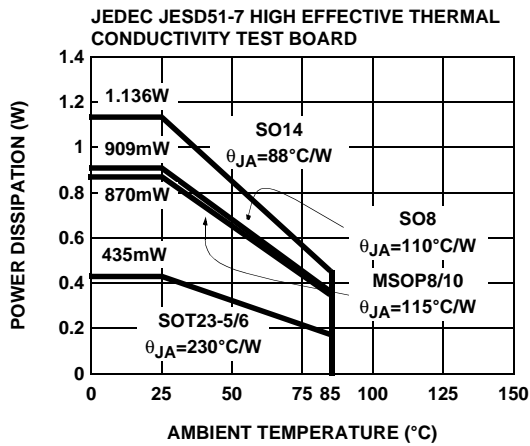

FIGURE 1. PACKAGE POWER DISSIPATION vs AMBIENT TEMPERATURE

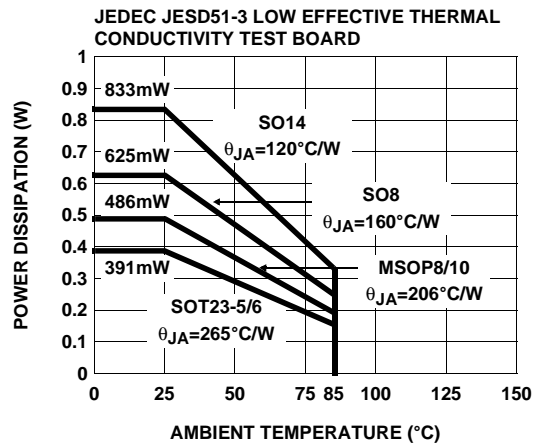

FIGURE 2. PACKAGE POWER DISSIPATION vs AMBIENT TEMPERATURE

All Intersil U.S. products are manufactured, assembled and tested utilizing ISO9000 quality systems. Intersil Corporation's quality certifications can be viewed at www.intersil.com/design/quality

Intersil products are sold by description only. Intersil Corporation reserves the right to make changes in circuit design, software and/or specifications at any time without notice. Accordingly, the reader is cautioned to verify that data sheets are current before placing orders. Information furnished by Intersil is believed to be accurate and reliable. However, no responsibility is assumed by Intersil or its subsidiaries for its use; nor for any infringements of patents or other rights of third parties which may result from its use. No license is granted by implication or otherwise under any patent or patent rights of Intersil or its subsidiaries.

For information regarding Intersil Corporation and its products, see www.intersil.com