



# Triple/Quad, 2:1 Video Multiplexer-Amplifiers with Input Clamps

## General Description

The MAX4028/MAX4029 are 5V, triple/quad, 2:1 voltage-feedback multiplexer-amplifiers with input clamps and a fixed gain of +2V/V (6dB). Channel 1 (IN1A and IN1B) inputs are clamped to the video sync tip of the input signal, while the remaining inputs can be clamped to either the video sync tip or the video sync of channel 1 (IN1<sub>-</sub>). The latter is referred to as a key clamp and is pin selectable. Selectable clamp/key-clamp inputs and fixed-gain video output buffers make the MAX4028/MAX4029 ideal for video-source switching applications such as automotive entertainment systems, video projectors, and displays/TVs. Both devices have 20ns channel switching times and low  $\pm 10\text{mV}_{\text{P-P}}$  switching transients, making them ideal for high-speed video switching applications such as on-screen display (OSD) insertion.

The MAX4028/MAX4029 have a -3dB large-signal ( $2\text{V}_{\text{P-P}}$ ) bandwidth of 130MHz, a -3dB small-signal bandwidth of 210MHz, and a  $300\text{V}/\mu\text{s}$  slew rate. Low differential gain and phase errors of 0.2% and  $0.4^\circ$ , respectively, make these devices ideal for broadcast video applications.

The MAX4028/MAX4029 are specified over the  $-40^\circ\text{C}$  to  $+85^\circ\text{C}$  extended temperature range and are offered in 16-pin and 20-pin TSSOP/SO packages.

## Applications

- In-Car Navigation/Entertainment
- Blade Servers
- Security Systems
- Video Projectors
- Displays and Digital Televisions
- Broadcast and Graphics Video
- Set-Top Boxes
- Notebook Computers
- Video Crosspoint Switching

## Selector Guide

PART	NO. OF 2:1 MUX-AMPS	GAIN
MAX4028	3	2V/V
MAX4029	4	2V/V

Pin Configurations appear at end of data sheet.



Maxim Integrated Products 1

For pricing, delivery, and ordering information, please contact Maxim/Dallas Direct! at 1-888-629-4642, or visit Maxim's website at [www.maxim-ic.com](http://www.maxim-ic.com).

## Features

- ◆ Single +5V Operation
- ◆ Independently Selectable Sync-Tip or Key-Clamp Inputs
- ◆ Adjustable Key-Clamp Voltage
- ◆ 130MHz Large-Signal -3dB Bandwidth
- ◆ 210MHz Small-Signal -3dB Bandwidth
- ◆  $300\text{V}/\mu\text{s}$  Slew Rate
- ◆ 20ns Switching Time
- ◆ Ultra-Low  $\pm 10\text{mV}_{\text{P-P}}$  Switching Transient
- ◆ 0.2% Differential Gain/ $0.4^\circ$  Phase Error
- ◆ Low-Power, High-Impedance Disable Mode

## Ordering Information

PART	TEMP RANGE	PIN-PACKAGE
MAX4028EUE	$-40^\circ\text{C}$ to $+85^\circ\text{C}$	16 TSSOP
MAX4028EWE	$-40^\circ\text{C}$ to $+85^\circ\text{C}$	16 Wide SO
MAX4029EUP	$-40^\circ\text{C}$ to $+85^\circ\text{C}$	20 TSSOP
MAX4029EWP	$-40^\circ\text{C}$ to $+85^\circ\text{C}$	20 Wide SO

## Typical Operating Circuit

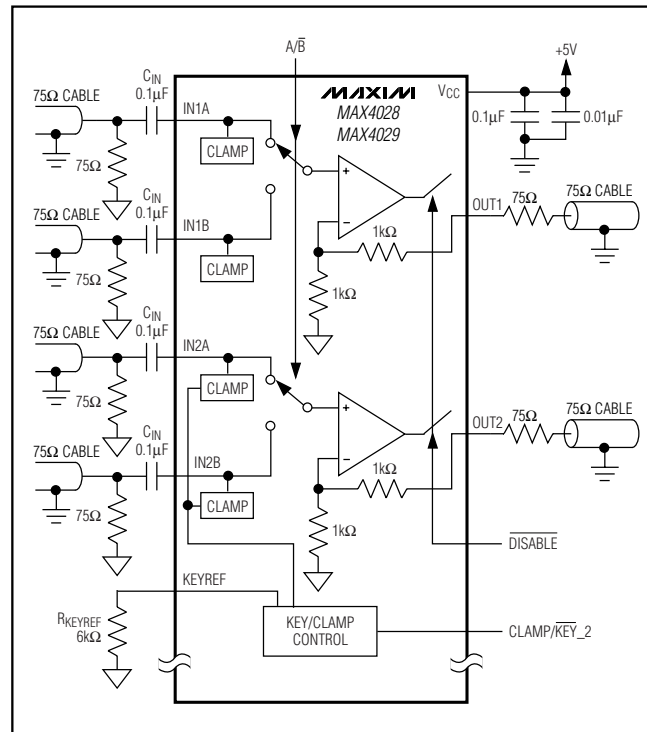

MAX4028/MAX4029

# Triple/Quad, 2:1 Video Multiplexer-Amplifiers with Input Clamps

## ABSOLUTE MAXIMUM RATINGS

Supply Voltage (V <sub>CC</sub> to GND) .....	-0.3V to +6V	20-Pin TSSOP (derate 11mW/°C above +70°C) .....	879mW
IN_A, IN_B, OUT .....	-0.3V to (V <sub>CC</sub> + 0.3V)	20-Pin Wide SO (derate 10mW/°C above +70°C) .....	800mW
DISABLE, A/B, KEYREF, CLAMP/KEY_ .....	-0.3V to (V <sub>CC</sub> + 0.3V)	Operating Temperature Range .....	-40°C to +85°C
Current Into IN_A, IN_B .....	±0.5mA	Junction Temperature .....	+150°C
Short-Circuit Duration (V <sub>OUT</sub> to GND) .....	Continuous	Storage Temperature Range .....	-65°C to +150°C
Short-Circuit Duration (V <sub>OUT</sub> to V <sub>CC</sub> ) .....	(Note 1)	Lead Temperature (soldering, 10s) .....	+300°C
Continuous Power Dissipation (T <sub>A</sub> = +70°C)			
16-Pin TSSOP (derate 9.4mW/°C above +70°C) .....	755mW		
16-Pin Wide SO (derate 9.5mW/°C above +70°C) .....	762mW		

**Note 1:** Do not short V<sub>OUT</sub> to V<sub>CC</sub>.

Stresses beyond those listed under "Absolute Maximum Ratings" may cause permanent damage to the device. These are stress ratings only, and functional operation of the device at these or any other conditions beyond those indicated in the operational sections of the specifications is not implied. Exposure to absolute maximum rating conditions for extended periods may affect device reliability.

## DC ELECTRICAL CHARACTERISTICS

(V<sub>CC</sub> = +5V, GND = 0V, R<sub>L</sub> = 150Ω to GND, V<sub>DISABLE</sub> = +5V, R<sub>KEYREF</sub> = 6kΩ, C<sub>IN</sub> = 0.1μF to GND, T<sub>A</sub> = T<sub>MIN</sub> to T<sub>MAX</sub>, unless otherwise noted. Typical values are at T<sub>A</sub> = +25°C.) (Note 2)

PARAMETER	SYMBOL	CONDITIONS	MIN	TYP	MAX	UNITS
Operating Supply Voltage Range	V <sub>CC</sub>	Guaranteed by PSRR	4.5		5.5	V
Quiescent Supply Current	I <sub>CC</sub>	MAX4028, R <sub>L</sub> = ∞		29	40	mA
		MAX4029, R <sub>L</sub> = ∞		38	55	
Disable Supply Current	V <sub>DISABLE</sub> = 0V	MAX4028		9	15	mA
		MAX4029		11	20	
Output Clamp Voltage	V <sub>CLAMP</sub>	Clamp (Note 3)	0.32	0.4	0.48	V
		Key clamp (Note 4)		1.1		
Input Clamping Current	I <sub>IN</sub>	Input voltage = input clamp + 0.5V		5	18	μA
Clamp Voltage Matching	ΔV <sub>CLAMP</sub>	Measured at output		10		mV
Clamp Voltage Drift	TC <sub>VCLAMP</sub>	Measured at output		80		μV/°C
Input Resistance	R <sub>IN</sub>			7		MΩ
Output Resistance	R <sub>OUT</sub>			0.7		Ω
Disable Output Resistance	R <sub>OUT</sub>	V <sub>DISABLE</sub> = 0V		2		kΩ
Power-Supply Rejection Ratio	PSRR	4.5V < V <sub>CC</sub> < 5.5V (Note 5)	48	58		dB
Voltage Gain	A <sub>VCL</sub>		1.9	2.0	2.1	V/V
Channel-to-Channel Gain Matching	ΔA <sub>VCL</sub>			±1	±2	%
Output-Voltage High	V <sub>OH</sub>		V <sub>CLAMP</sub> + 2.4			V
Output-Voltage Low	V <sub>OL</sub>				V <sub>CLAMP</sub>	V
Output Current	I <sub>OUT</sub>		30			mA
<b>LOGIC INPUT CHARACTERISTICS (DISABLE, A/B, CLAMP/KEY_)</b>						
Logic-Low Threshold	V <sub>IL</sub>				0.8	V
Logic-High Threshold	V <sub>IH</sub>		2.0			V
Logic-Low Input Current	I <sub>IL</sub>	V <sub>IL</sub> = 0V		6.6	25	μA
Logic-High Input Current	I <sub>IH</sub>	V <sub>IH</sub> = V <sub>CC</sub>		1.2	25	μA

# Triple/Quad, 2:1 Video Multiplexer-Amplifiers with Input Clamps

MAX4028/MAX4029

## AC ELECTRICAL CHARACTERISTICS

( $V_{CC} = +5V$ ,  $GND = 0V$ ,  $R_L = 150\Omega$  to  $GND$ ,  $V_{DISABLE} = +5V$ ,  $R_{KEYREF} = 6k\Omega$ ,  $C_{IN} = 0.1\mu F$ ,  $T_A = T_{MIN}$  to  $T_{MAX}$ , unless otherwise noted. Typical values are at  $T_A = +25^\circ C$ .)

PARAMETER	SYMBOL	CONDITIONS	MIN	TYP	MAX	UNITS
Small-Signal -3dB Bandwidth	BW <sub>SS</sub>	$V_{OUT} = 100mV_{P-P}$		210		MHz
Large-Signal -3dB Bandwidth	BW <sub>LS</sub>	$V_{OUT} = 2V_{P-P}$		130		MHz
Small-Signal 0.1dB Gain Flatness Bandwidth	BW <sub>0.1dBSS</sub>	$V_{OUT} = 100mV_{P-P}$		30		MHz
Large-Signal 0.1dB Gain Flatness Bandwidth	BW <sub>0.1dBLS</sub>	$V_{OUT} = 2V_{P-P}$		30		MHz
Slew Rate	SR	$V_{OUT} = 2V_{P-P}$		300		V/ $\mu s$
Settling Time to 0.1%	t <sub>s</sub>	$V_{OUT} = 2V$ step		20		ns
Power-Supply Rejection Ratio	PSRR	f = 100kHz		55		dB
Output Impedance	Z <sub>O</sub>	f = 100kHz		0.7		$\Omega$
Differential Gain Error	DG	5-step modulated staircase		0.2		%
Differential Phase Error	DP	5-step modulated staircase		0.4		degrees
Group Delay	D/dT	f = 3.58MHz or 4.43MHz		1.0		ns
Peak Signal to RMS Noise	SNR	100kHz to 30MHz		70		dB
Channel-to-Channel Crosstalk	X <sub>TALK</sub>	f = 100kHz		73		dB
A/B Crosstalk	X <sub>TALKAB</sub>	f = 100kHz		91		dB
Off-Isolation	A <sub>ISO</sub>	$V_{OUT\_} = 2V_{P-P}$ , f = 100kHz		108		dB
Droop	D <sub>R</sub>	Guaranteed by input clamp current			2	%
<b>SWITCHING CHARACTERISTICS</b>						
Channel Switching Time	t <sub>SW</sub>			20		ns
Enable Time	t <sub>ON</sub>			0.1		$\mu s$
Disable Time	t <sub>OFF</sub>			0.1		$\mu s$
Switching Transient				$\pm 10$		mV <sub>P-P</sub>

**Note 2:** All devices are 100% production tested at  $T_A = +25^\circ C$ . Specifications over temperature are guaranteed by design.

**Note 3:** The clamp voltage at the input is  $V_{CLAMP}$  (measured at the output) divided by gain +  $V_{BE}$ .

**Note 4:** The key-clamp voltage is above the sync-tip clamp voltage by approximately 0.7V, and is adjusted by varying  $R_{KEYREF}$ .

**Note 5:** Measured at f = 100Hz at thermal equilibrium.

# Triple/Quad, 2:1 Video Multiplexer-Amplifiers with Input Clamps

## Typical Operating Characteristics

( $V_{CC} = +5V$ ,  $GND = 0V$ ,  $V_{DISABLE} = +5V$ ,  $R_L = 150\Omega$  to  $GND$ ,  $C_{IN} = 0.1\mu F$ ,  $R_{KEYREF} = 6.04k\Omega \pm 1\%$ ,  $T_A = +25^\circ C$ , unless otherwise noted.)

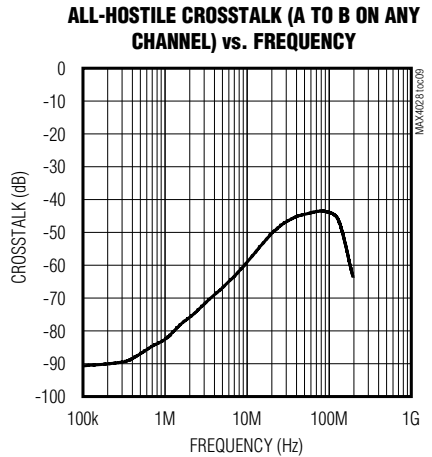
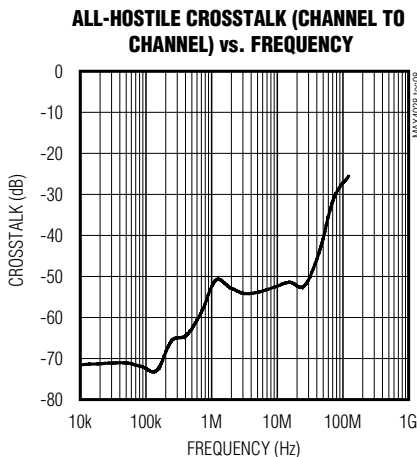
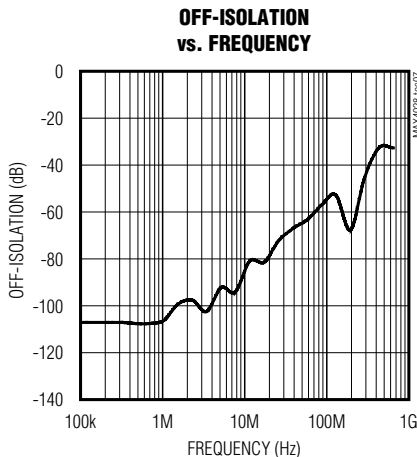
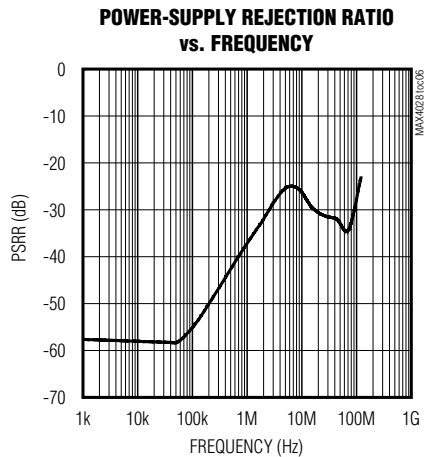
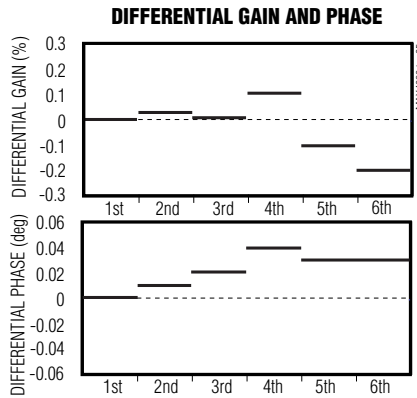
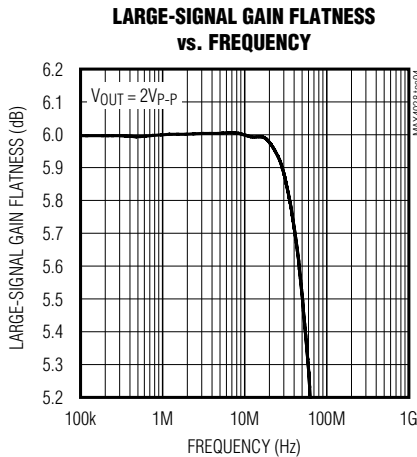
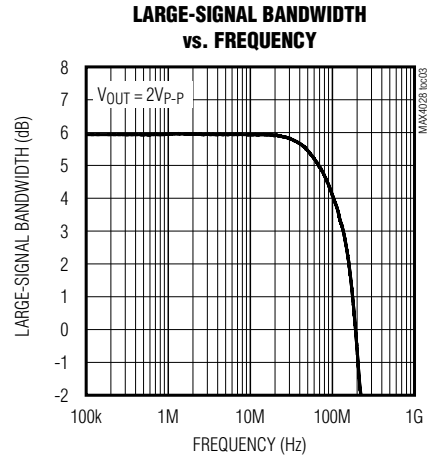
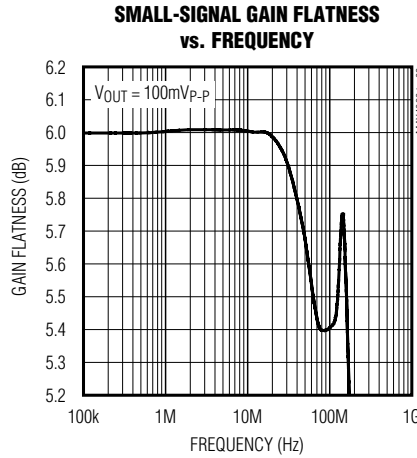
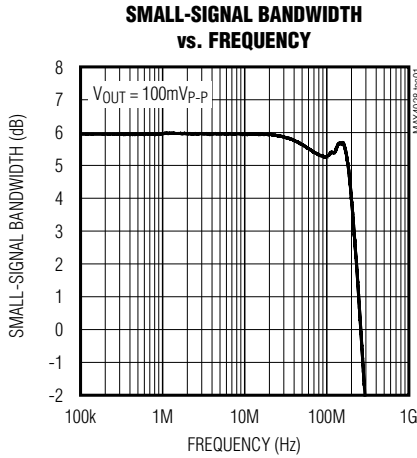

# Triple/Quad, 2:1 Video Multiplexer-Amplifiers with Input Clamps

## Typical Operating Characteristics (continued)

( $V_{CC} = +5V$ ,  $GND = 0V$ ,  $V_{DISABLE} = +5V$ ,  $R_L = 150\Omega$  to  $GND$ ,  $C_{IN} = 0.1\mu F$ ,  $R_{KEYREF} = 6.04k\Omega \pm 1\%$ ,  $T_A = +25^\circ C$ , unless otherwise noted.)

MAX4028/MAX4029

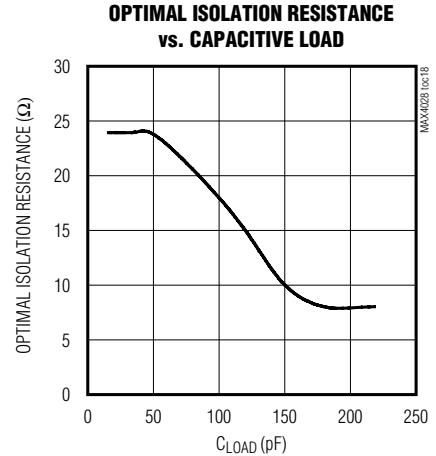
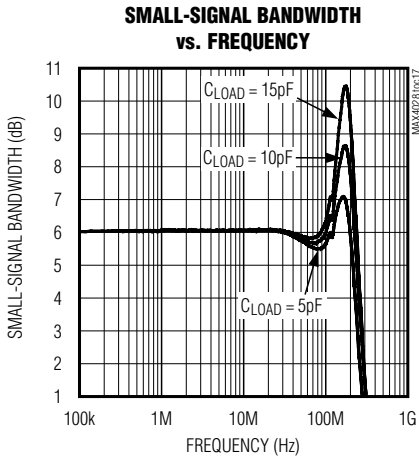
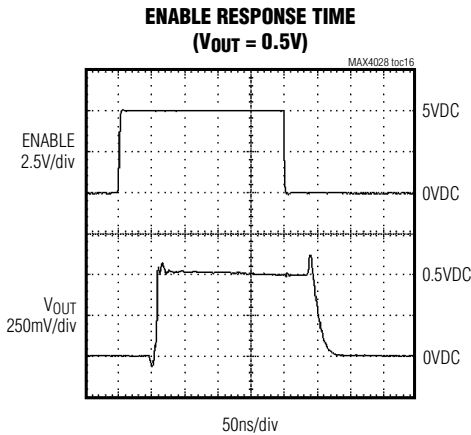
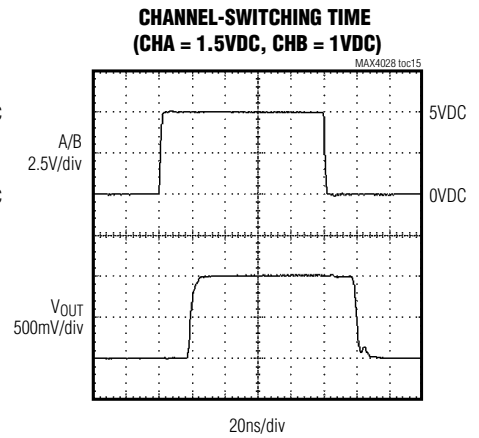
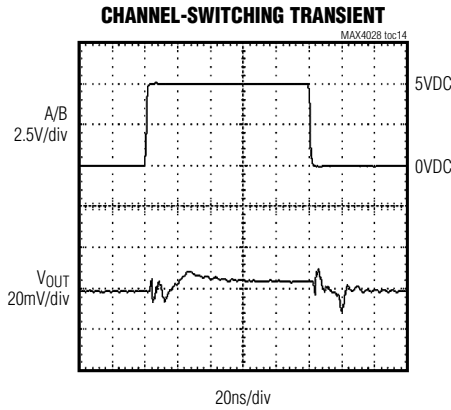
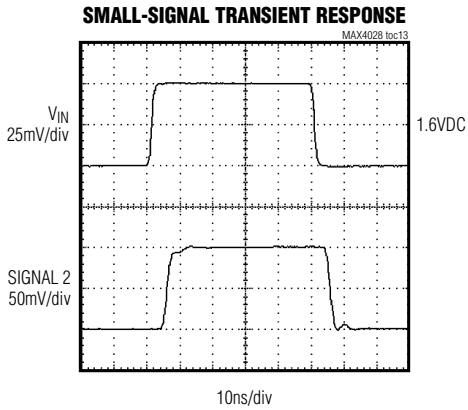
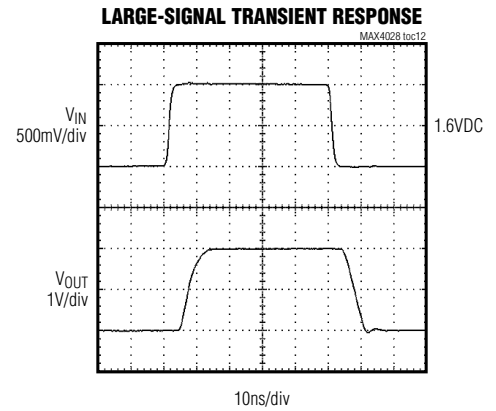
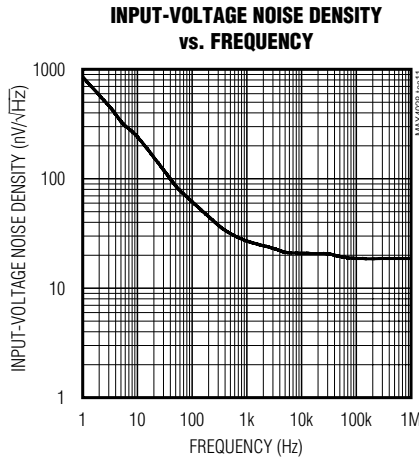
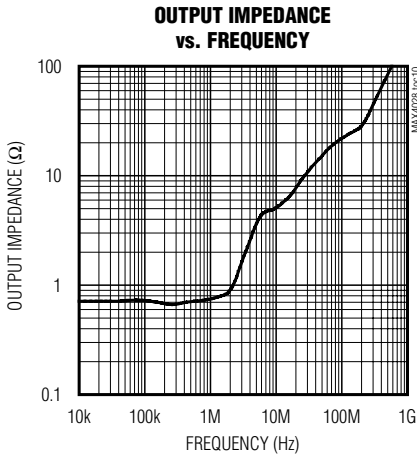

# Triple/Quad, 2:1 Video Multiplexer-Amplifiers with Input Clamps

## Typical Operating Characteristics (continued)

( $V_{CC} = +5V$ ,  $GND = 0V$ ,  $V_{DISABLE} = +5V$ ,  $R_L = 150\Omega$  to  $GND$ ,  $C_{IN} = 0.1\mu F$ ,  $R_{KEYREF} = 6.04k\Omega \pm 1\%$ ,  $T_A = +25^\circ C$ , unless otherwise noted.)

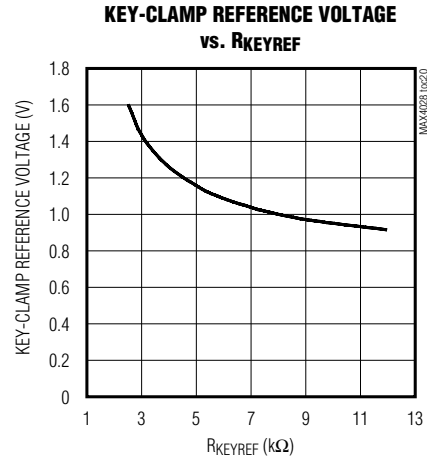
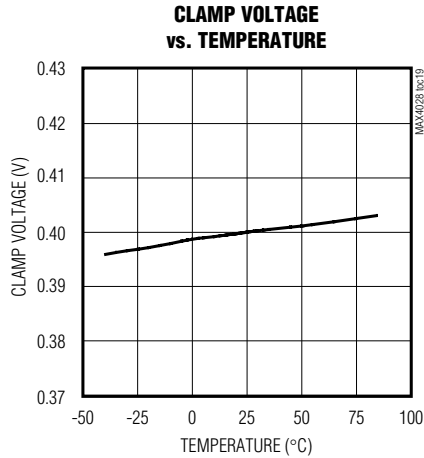

## Pin Description

PIN		NAME	FUNCTION
MAX4028	MAX4029		
—	1	IN4A	Amplifier Input 4A
1	2	IN3A	Amplifier Input 3A
2	3	IN2A	Amplifier Input 2A
3	4	IN1A	Amplifier Input 1A
4	5	A/B	Channel-Select Input. Drive A/B high or leave floating to select channel A. Drive A/B low to select channel B.
5	6	KEYREF	Key-Clamp Reference Output. Connect an external resistor from KEYREF to GND to generate the key-clamp voltage.
6	7	IN1B	Amplifier Input 1B
7	8	IN2B	Amplifier Input 2B
8	9	IN3B	Amplifier Input 3B
—	10	IN4B	Amplifier Input 4B
—	11	OUT4	Amplifier Output 4
9	12	CLAMP/KEY_3	Output 3 Clamp or Key-Clamp Input. Drive CLAMP/KEY_3 high to clamp OUT3. Drive CLAMP/KEY_3 low to key clamp OUT3.
10	13	GND	Ground
11	14	OUT3	Amplifier Output 3
12	15	CLAMP/KEY_2	Output 2 Clamp or Key-Clamp Input. Drive CLAMP/KEY_2 high to clamp OUT2. Drive CLAMP/KEY_2 low to key clamp OUT2.
13	16	OUT2	Amplifier Output 2
14	17	VCC	Power-Supply Voltage. Bypass VCC to GND with 0.1μF and 0.01μF capacitors as close to the pin as possible.

# Triple/Quad, 2:1 Video Multiplexer-Amplifiers with Input Clamps

## Pin Description (continued)

PIN		NAME	FUNCTION
MAX4028	MAX4029		
15	18	OUT1	Amplifier Output 1
16	19	$\overline{\text{DISABLE}}$	Disable Input. Pull $\overline{\text{DISABLE}}$ high for normal operation. Drive $\overline{\text{DISABLE}}$ low to disable all outputs.
—	20	CLAMP/ $\overline{\text{KEY}}_4$	Output 4 Clamp or Key-Clamp Input. Drive CLAMP/ $\overline{\text{KEY}}_4$ high to clamp OUT4. Drive CLAMP/ $\overline{\text{KEY}}_4$ low to key clamp OUT4.

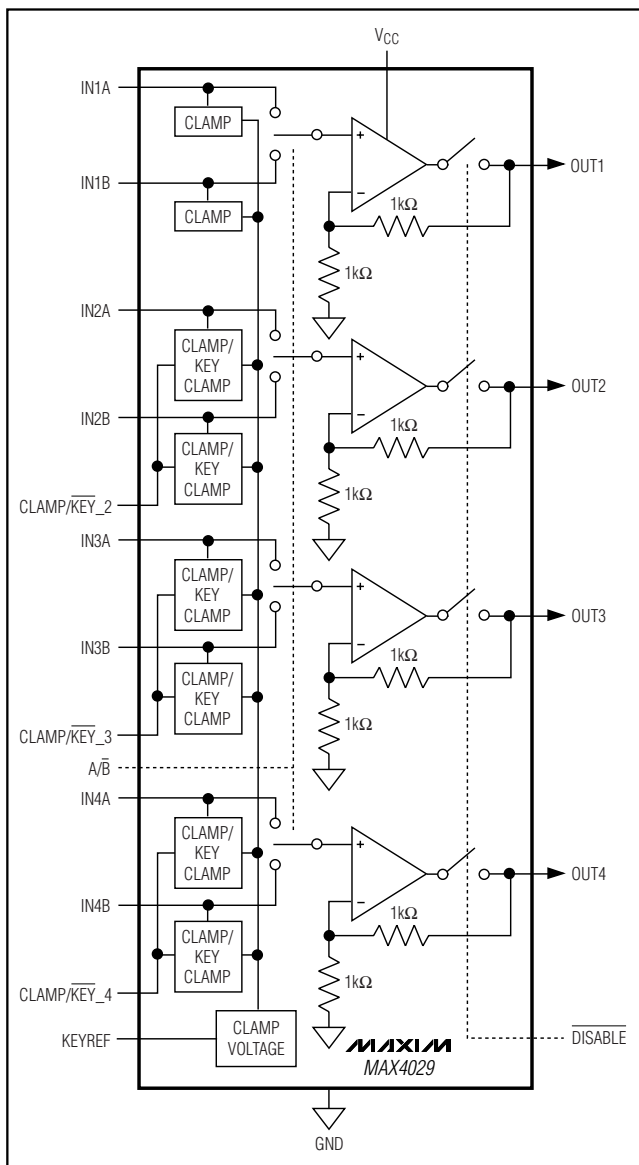

Figure 1. MAX4029 Functional Diagram

## Detailed Description

The MAX4028/MAX4029 are 5V, triple/quad, 2:1 voltage-feedback multiplexer-amplifiers with input clamps and a fixed gain of +2V/V (6dB). Channel 1 (IN1A and IN1B) inputs are clamped to the video sync tip of the input IN1\_ channel, while the remaining inputs can be clamped to either the video sync tip of the respective input channel (IN\_A and IN\_B) or the video sync of channel 1 (IN1\_). The latter is referred to as a key clamp and is pin selectable. Selectable clamp/key-clamp inputs and fixed-gain video output buffers make the MAX4028/MAX4029 ideal for video-source switching applications such as automotive entertainment systems, video projectors, and displays/TVs. Both devices have 20ns channel switching times and low  $\pm 10\text{mV}_{\text{P-P}}$  switching transients, making them ideal for both high-speed video switching applications such as OSD insertion.

The MAX4028/MAX4029 have a -3dB large-signal ( $2\text{V}_{\text{P-P}}$ ) bandwidth of 130MHz, a -3dB small-signal bandwidth of 210MHz, and a  $300\text{V}/\mu\text{s}$  slew rate. Low differential gain and phase errors of 0.2% and  $0.4^\circ$ , respectively, make these devices ideal for broadcast video applications.

### Sync Tip and Key Clamps

The MAX4028/MAX4029 have AC-coupled inputs, with either a sync tip or key clamp to provide bias for the video signal. Channel 1 of the MAX4028/MAX4029 always has a sync tip clamp at the input, while the remaining channels are selectable as either sync tip or key clamps to accommodate the various video waveforms (see the *Clamp/Key-Clamp Settings for Video Formats* section). The value of the sync-tip clamp voltage is set internally for the lowest value, consistent with linear operation, and cannot be adjusted. The key-clamp voltage is adjustable, to compensate for variations in the voltage between component video inputs such as Linear RGB, YPbPr, and Y-C, by varying RKEYREF. The key-clamp voltage can be computed from:

$$V_{\text{Key-Clamp}} = 0.40 + \frac{2000 \cdot R_{\text{KEYREF}}}{5000 + R_{\text{KEYREF}}}$$

## Triple/Quad, 2:1 Video Multiplexer-Amplifiers with Input Clamps

Therefore, a  $6\text{k}\Omega$  resistor will produce a  $1.13\text{V}$  key-clamp voltage as shown in Figure 2. The clamp voltage ( $V_{\text{CLAMP}}$ ) is measured at the output; the voltage at the input is  $V_{\text{CLAMP}}$  (sync tip or key clamp) divided by the gain  $(+2V/V) + V_{\text{BE}}$ .

In order for these clamps (sync tip or key) to work properly, the input must be coupled with a  $0.1\mu\text{F}$  capacitor (typ) with low leakage ( $<1\mu\text{A}$  to  $2\mu\text{A}$ , max). Without proper coupling, the clamp voltage will change during the horizontal line time causing the “black level” to vary, changing the image brightness from left to right on the display. In addition

to the capacitor, a low resistance ( $\leq 75\Omega$ ) is required on the source side to return the capacitor to ground. The clamps used here are active devices with the coupling capacitor serving two functions; first, as a charge reservoir to maintain the clamp voltage, and second, as the compensation capacitor for the clamp itself. If an input is not used, it must be terminated to avoid causing oscillations that could couple with another input.

In general, a sync-tip clamp is used for composite video (Cvbs), gamma corrected primaries (R'G'B'), and the luma signal (Y) in S-video. A key clamp is preferred for component color difference signals (Pb and Pr), linear primaries (RGB in PCs), and chroma (C) in S-video. The rule is to sync tip clamp a signal if sync is present and key clamp all others. Several examples are given in the *Clamp/Key-Clamp Settings for Video Formats* section.

### Clamp/Key-Clamp Settings for Video Formats

Tables 1 and 2 provide the clamp settings on the MAX4028/MAX4029 to interface with various video formats.

### Low-Power, High-Impedance Disable Mode

All parts feature a low-power, high-impedance disable mode that is activated by driving the  $\overline{\text{DISABLE}}$  input low. Placing the amplifier in disable mode reduces the quiescent supply current and places the output impedance at  $2\text{k}\Omega$  typically. Multiple devices can be paralleled to construct larger switch matrices by connecting the outputs of several devices together and disabling all but one of the paralleled amplifiers' outputs.

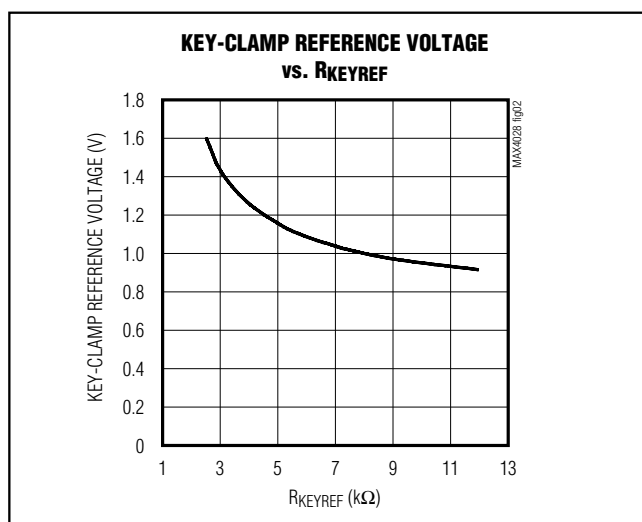

Figure 2. Key-Clamp Reference Voltage vs.  $R_{\text{KEYREF}}$

Table 1. MAX4028 Clamp Settings for Video Formats

INPUT	FORMAT	CLAMP/KEY
1	Cvbs1	Clamp
2	Cvbs2	Clamp
3	Cvbs3	Clamp

INPUT	FORMAT	CLAMP/KEY
1	G'	Clamp
2	B'	Clamp
3	R'	Clamp

R, G, B have sync on all.

INPUT	FORMAT	CLAMP/KEY
1	Gs	Clamp
2	B	Key
3	R	Key

Gs, B, R have sync only on Green.

INPUT	FORMAT	CLAMP/KEY
1	Y	Clamp
2	C	Key
3	Cvbs	Clamp

INPUT	FORMAT	CLAMP/KEY
1	Y	Clamp
2	Pb	Key
3	Pr	Key



# Triple/Quad, 2:1 Video Multiplexer-Amplifiers with Input Clamps

**Table 2. MAX4029 Clamp Settings for Video Formats**

INPUT	FORMAT	CLAMP/KEY
1	Cvbs1	Clamp
2	Cvbs2	Clamp
3	Cvbs3	Clamp
4	Cvbs4	Clamp

INPUT	FORMAT	CLAMP/KEY
1	H-Sync	Clamp
2	G	Key
3	B	Key
4	R	Key

*R, G, B have sync on none.*

INPUT	FORMAT	CLAMP/KEY
1	Y	Clamp
2	C	Key
3	Cvbs	Clamp
4	Cvbs	Clamp

INPUT	FORMAT	CLAMP/KEY
1	Gs	Clamp
2	R	Key
3	B	Key
4	Cvbs	Clamp

*Gs, B, R have sync only on Green.*

INPUT	FORMAT	CLAMP/KEY
1	Y	Clamp
2	Pr	Key
3	Pb	Key
4	Cvbs	Clamp

*R, G, B have sync on all.*

The MAX4028/MAX4029 have a fixed gain of +2V/V that is internally set with two 1kΩ thin-film resistors. The impedance of the internal feedback resistors must be taken into account when operating multiple MAX4028/MAX4029s in large multiplexer applications.

## Applications Information

### Video Line Driver

The MAX4028/MAX4029 are well suited to drive coaxial transmission lines when the cable is terminated at both ends, as shown in Figure 3, where the fixed gain of +2V/V compensates for the loss in the resistors,  $R_T$ .

### Driving Capacitive Loads

A correctly terminated transmission line is purely resistive and presents no capacitive load to the amplifier. Reactive loads decrease phase margin and may produce excessive ringing and oscillation.

Another concern when driving capacitive loads is the amplifier's output impedance, which appears inductive at high frequencies. This inductance forms an L-C reso-

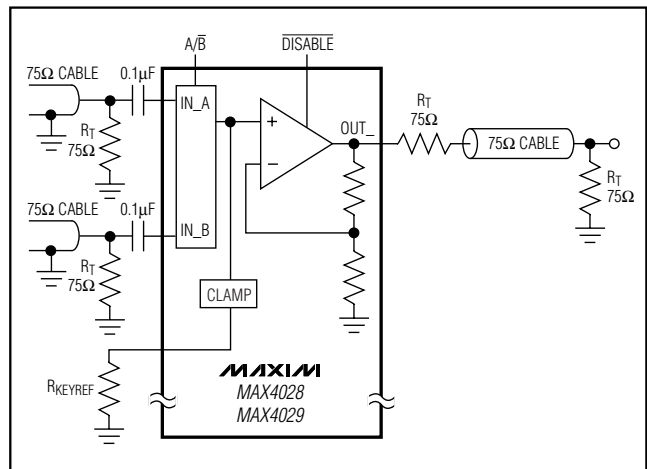

Figure 3. Video Line Driver

nant circuit with the capacitive load, which causes peaking in the frequency response and degrades the amplifier's phase margin.

# Triple/Quad, 2:1 Video Multiplexer-Amplifiers with Input Clamps

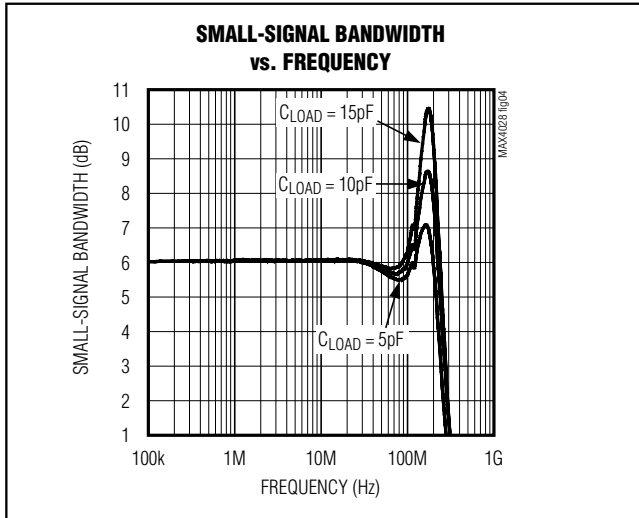

Figure 4. Small-Signal Gain vs. Frequency with Capacitive Load and No Isolation Resistor

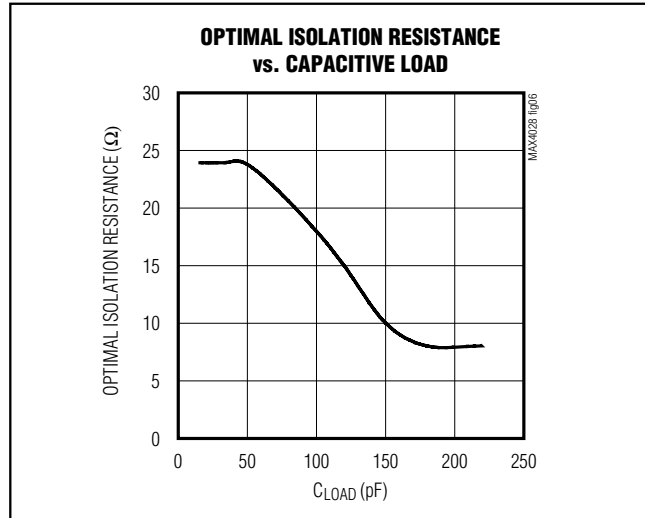

Figure 6. Optimal Isolation Resistance vs. Capacitive Load

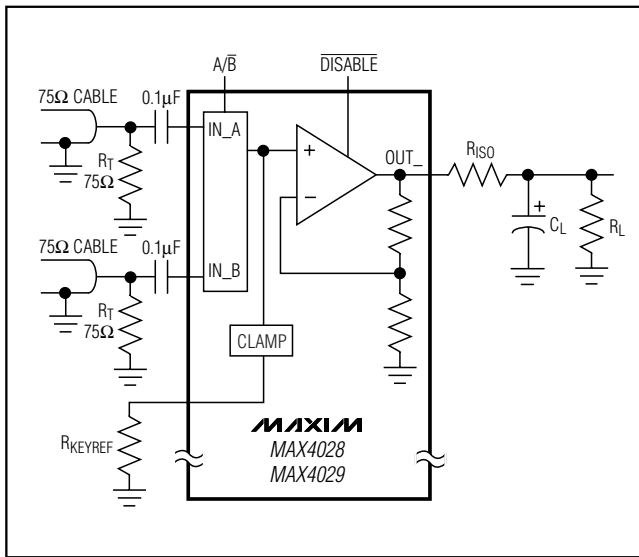

Figure 5. Using an Isolation Resistor ( $R_{ISO}$ ) for a High-Capacitive Load

Although the MAX4028/MAX4029 are optimized for AC performance and are not designed to drive highly capacitive loads, they are capable of driving up to 15pF without oscillations. However, some peaking may occur in the frequency domain (Figure 4). To drive larger capacitive loads or to reduce ringing, add an isolation resistor between the amplifier's output and the load (Figure 5). The value of  $R_{ISO}$  depends on the circuit's

gain (+2V/V) and the capacitive load (Figure 6). Also note that the isolation resistor forms a divider that decreases the voltage delivered to the load.

### Layout and Power-Supply Bypassing

The MAX4028/MAX4029 have high bandwidths and consequently require careful board layout, including the possible use of constant-impedance microstrip or stripline techniques.

To realize the full AC performance of these high-speed amplifiers, pay careful attention to power-supply bypassing and board layout. The PC board should have at least two layers: a signal and power layer on one side, and a large, low-impedance ground plane on the other side. The ground plane should be as free of voids as possible. Whether or not a constant-impedance board is used, it is best to observe the following guidelines when designing the board:

- 1) Do not use wire-wrapped boards or breadboards.
- 2) Do not use IC sockets; they increase parasitic capacitance and inductance.
- 3) Keep signal lines as short and straight as possible. Do not make 90° turns; round all corners.
- 4) Observe high-frequency bypassing techniques to maintain the amplifier's accuracy and stability.
- 5) Use surface-mount components. They generally have shorter bodies and lower parasitic reactance, yielding better high-frequency performance than through-hole components.

# Triple/Quad, 2:1 Video Multiplexer-Amplifiers with Input Clamps

The bypass capacitors should include a 0.1μF, ceramic surface-mount capacitor between V<sub>CC</sub> and the ground plane, located as close to the package as possible. Optionally, place a 10μF capacitor at the power supply's point-of-entry to the PC board to ensure the integrity of incoming supplies. The power-supply traces should lead

directly from the capacitor to the V<sub>CC</sub> pin. To minimize parasitic inductance, keep PC traces short and use surface-mount components.

If input termination resistors and output back-termination resistors are used, they should be surface-mount types, and should be placed as close to the IC pins as possible.

## Pin Configurations

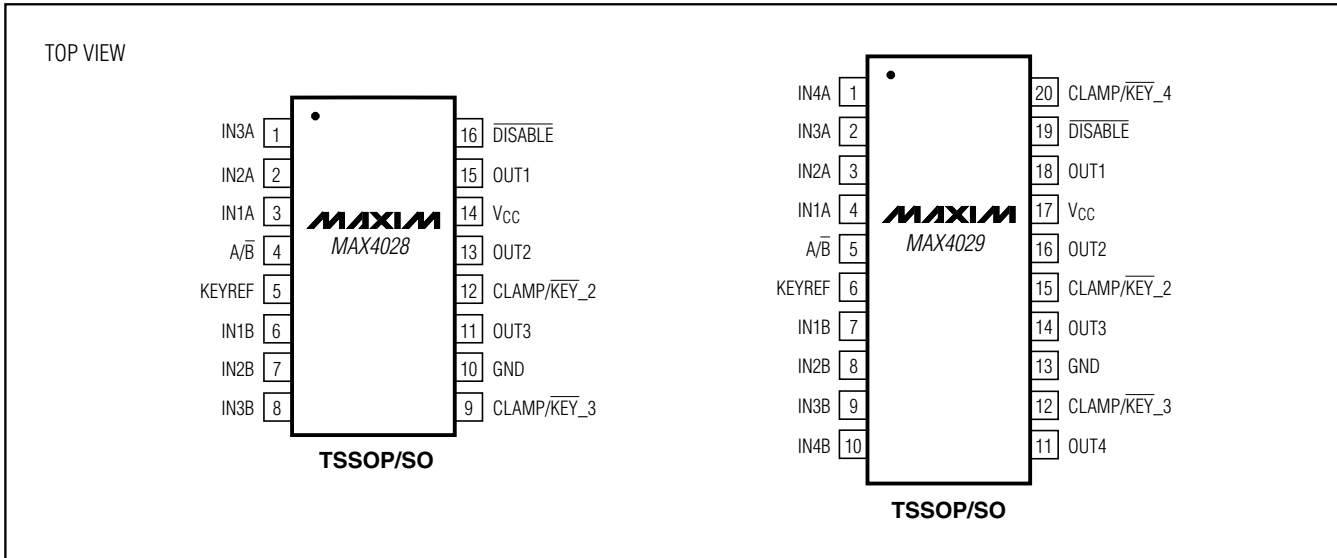

## Chip Information

TRANSISTOR COUNT: 1032

PROCESS: Bipolar

# Triple/Quad, 2:1 Video Multiplexer-Amplifiers with Input Clamps

## Package Information

(The package drawing(s) in this data sheet may not reflect the most current specifications. For the latest package outline information, go to [www.maxim-ic.com/packages](http://www.maxim-ic.com/packages).)

TSSOP4.40mm.EPS

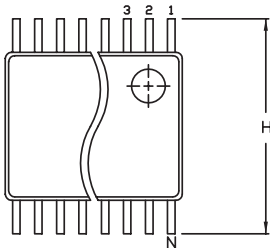

TOP VIEW

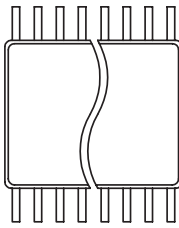

BOTTOM VIEW

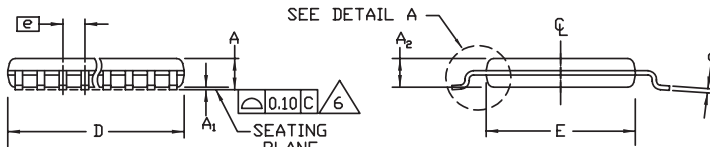

SIDE VIEW

END VIEW

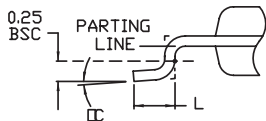

DETAIL A

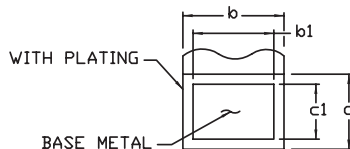

LEAD TIP DETAIL

	COMMON DIMENSIONS			
	MILLIMETERS		INCHES	
	MIN.	MAX.	MIN.	MAX.
A	—	1.10		.043
A <sub>1</sub>	0.05	0.15	.002	.006
A <sub>2</sub>	0.85	0.95	.033	.037
b	0.19	0.30	.007	.012
b <sub>1</sub>	0.19	0.25	.007	.010
C	0.09	0.20	.004	.008
C <sub>1</sub>	0.09	0.14	.004	.006
D	SEE VARIATIONS	SEE VARIATIONS	SEE VARIATIONS	SEE VARIATIONS
E	4.30	4.50	.169	.177
e	0.65 BSC		.026 BSC	
H	6.25	6.55	.246	.258
L	0.50	0.70	.020	.028
N	SEE VARIATIONS	SEE VARIATIONS	SEE VARIATIONS	SEE VARIATIONS
α	0°	8°	0°	8°

JEDEC	N		VARIATIONS			
			MILLIMETERS		INCHES	
MD-153			MIN.	MAX.	MIN.	MAX.
AB-1	14	D	4.90	5.10	.193	.201
AB	16	D	4.90	5.10	.193	.201
AC	20	D	6.40	6.60	.252	.260
AD	24	D	7.70	7.90	.303	.311
AE	28	D	9.60	9.80	.378	.386

**NOTES:**

- DIMENSIONS D AND E DO NOT INCLUDE FLASH
  - MOLD FLASH OR PROTRUSIONS NOT TO EXCEED 0.15mm PER SIDE
  - CONTROLLING DIMENSION: MILLIMETER
  - MEETS JEDEC OUTLINE MD-153. SEE JEDEC VARIATIONS TABLE
  - 'N' REFERS TO NUMBER OF LEADS
- △ THE LEAD TIPS MUST LIE WITHIN A SPECIFIED ZONE. THIS TOLERANCE ZONE IS DEFINED BY TWO PARALLEL PLANES. ONE PLANE IS THE SEATING PLANE, DATUM [-C-]; THE OTHER PLANE IS AT THE SPECIFIED DISTANCE FROM [-C-] IN THE DIRECTION INDICATED

**DALLAS SEMICONDUCTOR** **MAXIM**

PROPRIETARY INFORMATION

TITLE:  
PACKAGE OUTLINE, TSSOP 4.40mm BODY

APPROVAL	DOCUMENT CONTROL NO. 21-0066	REV. F	1/1
----------	---------------------------------	-----------	-----

# Triple/Quad, 2:1 Video Multiplexer-Amplifiers with Input Clamps

## Package Information (continued)

(The package drawing(s) in this data sheet may not reflect the most current specifications. For the latest package outline information, go to [www.maxim-ic.com/packages](http://www.maxim-ic.com/packages).)

MAX4028/MAX4029

SOICWEP5

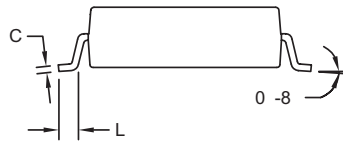
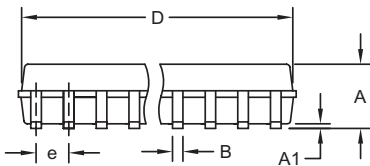
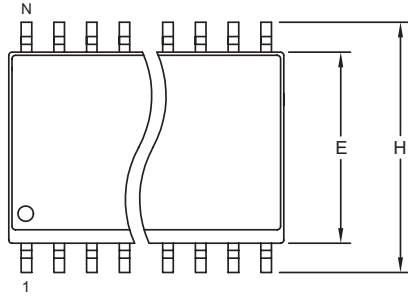

DIM	INCHES		MILLIMETERS	
	MIN	MAX	MIN	MAX
A	0.093	0.104	2.35	2.65
A1	0.004	0.012	0.10	0.30
B	0.014	0.019	0.35	0.49
C	0.009	0.013	0.23	0.32
e	0.050		1.27	
E	0.291	0.299	7.40	7.60
H	0.394	0.419	10.00	10.65
L	0.016	0.050	0.40	1.27

### VARIATIONS:

DIM	INCHES		MILLIMETERS		N	MS013
	MIN	MAX	MIN	MAX		
D	0.398	0.413	10.10	10.50	16	AA
D	0.447	0.463	11.35	11.75	18	AB
D	0.496	0.512	12.60	13.00	20	AC
D	0.598	0.614	15.20	15.60	24	AD
D	0.697	0.713	17.70	18.10	28	AE

### NOTES:

1. D&E DO NOT INCLUDE MOLD FLASH.
2. MOLD FLASH OR PROTRUSIONS NOT TO EXCEED 0.15mm (.006").
3. LEADS TO BE COPLANAR WITHIN 0.10mm (.004").
4. CONTROLLING DIMENSION: MILLIMETERS.
5. MEETS JEDEC MS013.
6. N = NUMBER OF PINS.

<small>PROPRIETARY INFORMATION</small>	
<small>TITLE:</small> PACKAGE OUTLINE, .300" SOIC	
<small>APPROVAL</small>	<small>DOCUMENT CONTROL NO.</small> 21-0042
<small>REV.</small> B	<small>1/1</small>

Maxim cannot assume responsibility for use of any circuitry other than circuitry entirely embodied in a Maxim product. No circuit patent licenses are implied. Maxim reserves the right to change the circuitry and specifications without notice at any time.

Maxim Integrated Products, 120 San Gabriel Drive, Sunnyvale, CA 94086 408-737-7600 \_\_\_\_\_ 13