



MICROCHIP

TC4467/TC4468/TC4469

Logic-Input CMOS Quad Drivers

Features

- High Peak Output Current: 1.2 A
- Wide Operating Range:
 - 4.5 V to 18 V
- Symmetrical Rise/Fall Times: 25 nsec
- Short, Equal Delay Times: 75 nsec
- Latch-proof. Will Withstand 500 mA Inductive Kickback
- 3 Input Logic Choices:
 - AND / NAND / AND + Inv
- ESD Protection on All Pins: 2 kV

Applications

- General Purpose CMOS Logic Buffer
- Driving All Four MOSFETs in an H-Bridge
- Direct Small Motor Driver
- Relay or Peripheral Drivers
- CCD Driver
- Pin-Switching Network Driver

General Description

The TC4467/TC4468/TC4469 devices are a family of four-output CMOS buffers/MOSFET drivers with 1.2 A peak drive capability. Unlike other MOSFET drivers, these devices have two inputs for each output. The inputs are configured as logic gates: NAND (TC4467), AND (TC4468) and AND/INV (TC4469).

The TC4467/TC4468/TC4469 drivers can continuously source up to 250 mA into ground referenced loads. These devices are ideal for direct driving low current motors or driving MOSFETs in a H-bridge configuration for higher current motor drive (see Section 5.0 for details). Having the logic gates onboard the driver can help to reduce component count in many designs.

The TC4467/TC4468/TC4469 devices are very robust and highly latch-up resistant. They can tolerate up to 5 V of noise spiking on the ground line and can handle up to 0.5 A of reverse current on the driver outputs.

The TC4467/4468/4469 devices are available in commercial, industrial and military temperature ranges.

Package Types

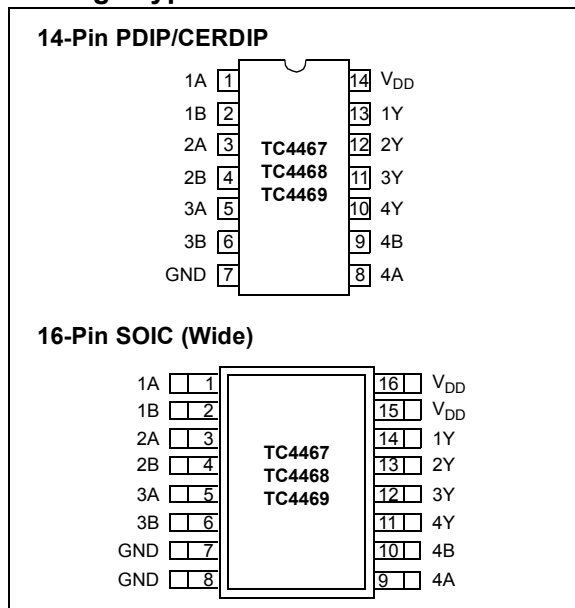

TC4467/TC4468/TC4469

Logic Diagrams

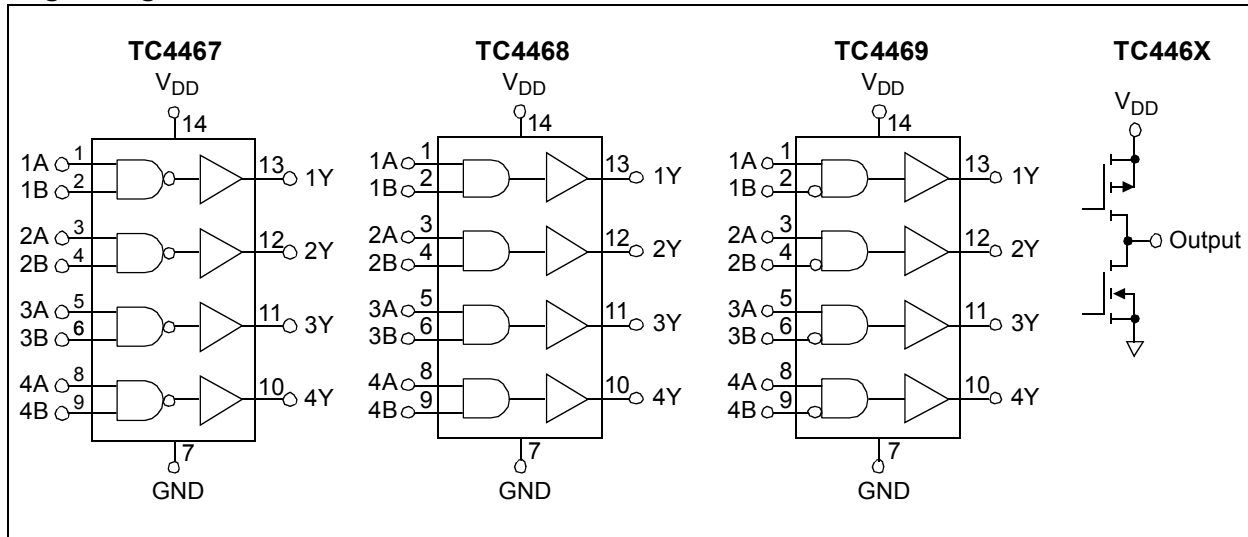

TC4467/TC4468/TC4469

1.0 ELECTRICAL CHARACTERISTICS

Absolute Maximum Ratings†

Supply Voltage	+20 V
Input Voltage	(GND – 5 V) to ($V_{DD} + 0.3 V$)
Package Power Dissipation: ($T_A \leq 70^\circ\text{C}$)	
PDIP	800 mW
CERDIP	840 mW
SOIC	760 mW
Package Thermal Resistance:	
CERDIP $R_{\theta J-A}$	100°C/W
CERDIP $R_{\theta J-C}$	23°C/W
PDIP $R_{\theta J-A}$	80°C/W
PDIP $R_{\theta J-C}$	35°C/W
SOIC $R_{\theta J-A}$	95°C/W
SOIC $R_{\theta J-C}$	28°C/W
Operating Temperature Range:	
C Version	0°C to +70°C
E Version	-40°C to +85°C
M Version	-55°C to +125°C
Maximum Chip Temperature	+150°C
Storage Temperature Range	-65°C to +150°C

†**Notice:** Stresses above those listed under "Maximum Ratings" may cause permanent damage to the device. This is a stress rating only and functional operation of the device at those or any other conditions above those indicated in the operation listings of this specification is not implied. Exposure to maximum rating conditions for extended periods may affect device reliability.

ELECTRICAL SPECIFICATIONS

Electrical Characteristics: Unless otherwise noted, $T_A = +25^\circ\text{C}$, with $4.5 V \leq V_{DD} \leq 18 V$.						
Parameters	Sym	Min	Typ	Max	Units	Conditions
Input						
Logic 1, High Input Voltage	V_{IH}	2.4	—	V_{DD}	V	Note 3
Logic 0, Low Input Voltage	V_{IL}	—	—	0.8	V	Note 3
Input Current	I_{IN}	-1.0	—	+1.0	μA	$0 V \leq V_{IN} \leq V_{DD}$
Output						
High Output Voltage	V_{OH}	$V_{DD} - 0.025$	—	—	V	$I_{LOAD} = 100 \mu\text{A}$ (Note 1)
Low Output Voltage	V_{OL}	—	—	0.15	V	$I_{LOAD} = 10 \text{ mA}$ (Note 1)
Output Resistance	R_O	—	10	15	Ω	$I_{OUT} = 10 \text{ mA}$, $V_{DD} = 18 V$
Peak Output Current	I_{PK}	—	1.2	—	A	
Continuous Output Current	I_{DC}	—	—	300	mA	Single Output
		—	—	500		Total Package
Latch-Up Protection Withstand Reverse Current	I	—	500	—	mA	$4.5 V \leq V_{DD} \leq 16 V$
Switching Time (Note 1)						
Rise Time	t_R	—	15	25	nsec	Figure 4-1
Fall Time	t_F	—	15	25	nsec	Figure 4-1
Delay Time	t_{D1}	—	40	75	nsec	Figure 4-1
Delay Time	t_{D2}	—	40	75	nsec	Figure 4-1
Power Supply						
Power Supply Current	I_S	—	1.5	4	mA	Note 2
Power Supply Voltage	V_{DD}	4.5	—	18	V	

- Note 1:** Totem pole outputs should not be paralleled because the propagation delay differences from one to the other could cause one driver to drive high a few nanoseconds before another. The resulting current spike, although short, may decrease the life of the device. Switching times are ensured by design.
- Note 2:** When driving all four outputs simultaneously in the same direction, V_{DD} will be limited to 16 V. This reduces the chance that internal dv/dt will cause high-power dissipation in the device.
- Note 3:** The input threshold has approximately 50 mV of hysteresis centered at approximately 1.5 V. Input rise times should be kept below 5 μsec to avoid high internal peak currents during input transitions. Static input levels should also be maintained above the maximum, or below the minimum, input levels specified in the "Electrical Characteristics" to avoid increased power dissipation in the device.

TC4467/TC4468/TC4469

ELECTRICAL SPECIFICATIONS (OPERATING TEMPERATURES)

Electrical Characteristics: Unless otherwise noted, over operating temperature range with $4.5\text{ V} \leq V_{DD} \leq 18\text{ V}$.						
Parameters	Sym	Min	Typ	Max	Units	Conditions
Input						
Logic 1, High Input Voltage	V_{IH}	2.4	—	—	V	Note 3
Logic 0, Low Input Voltage	V_{IL}	—	—	0.8	V	Note 3
Input Current	I_{IN}	-10	—	10	μA	$0\text{ V} \leq V_{IN} \leq V_{DD}$
Output						
High Output Voltage	V_{OH}	$V_{DD} - 0.025$	—	—	V	$I_{LOAD} = 100\ \mu\text{A}$ (Note 1)
Low Output Voltage	V_{OL}	—	—	0.30	V	$I_{LOAD} = 10\ \text{mA}$ (Note 1)
Output Resistance	R_O	—	20	30	Ω	$I_{OUT} = 10\ \text{mA}$, $V_{DD} = 18\ \text{V}$
Peak Output Current	I_{PK}	—	1.2	—	A	
Continuous Output Current	I_{DC}	—	—	300	mA	Single Output
		—	—	500		Total Package
Latch-Up Protection Withstand Reverse Current	I	—	500	—	mA	$4.5\text{ V} \leq V_{DD} \leq 16\text{ V}$
Switching Time (Note 1)						
Rise Time	t_R	—	15	50	nsec	Figure 4-1
Fall Time	t_F	—	15	50	nsec	Figure 4-1
Delay Time	t_{D1}	—	40	100	nsec	Figure 4-1
Delay Time	t_{D2}	—	40	100	nsec	Figure 4-1
Power Supply						
Power Supply Current	I_S	—	—	8	mA	Note 2
Power Supply Voltage	V_{DD}	4.5	—	18	V	

- Note 1:** Totem pole outputs should not be paralleled because the propagation delay differences from one to the other could cause one driver to drive high a few nanoseconds before another. The resulting current spike, although short, may decrease the life of the device. Switching times are ensured by design.
- Note 2:** When driving all four outputs simultaneously in the same direction, V_{DD} will be limited to 16 V. This reduces the chance that internal dv/dt will cause high-power dissipation in the device.
- Note 3:** The input threshold has approximately 50 mV of hysteresis centered at approximately 1.5 V. Input rise times should be kept below 5 μsec to avoid high internal peak currents during input transitions. Static input levels should also be maintained above the maximum, or below the minimum, input levels specified in the "Electrical Characteristics" to avoid increased power dissipation in the device.

TRUTH TABLE

Part No.	TC4467 NAND				TC4468 AND				TC4469 AND/INV			
Inputs A	H	H	L	L	H	H	L	L	H	H	L	L
Inputs B	H	L	H	L	H	L	H	L	H	L	H	L
Outputs TC446X	L	H	H	H	H	L	L	L	L	H	L	L

Legend: H = High L = Low

2.0 TYPICAL PERFORMANCE CURVES

Note: The graphs and tables provided following this note are a statistical summary based on a limited number of samples and are provided for informational purposes only. The performance characteristics listed herein are not tested or guaranteed. In some graphs or tables, the data presented may be outside the specified operating range (e.g., outside specified power supply range) and therefore outside the warranted range.

Note: $T_A = +25^\circ\text{C}$, with $4.5\text{ V} \leq V_{DD} \leq 18\text{ V}$.

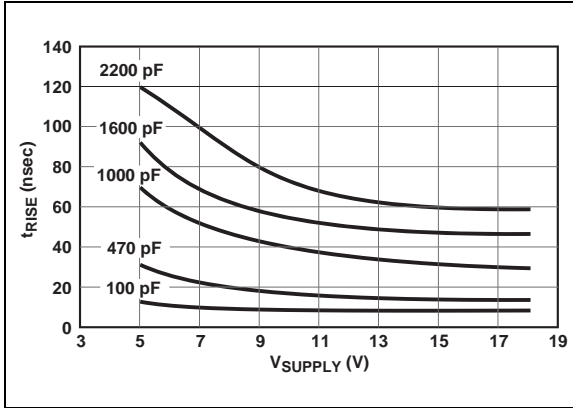

FIGURE 2-1: Rise Time vs. Supply Voltage.

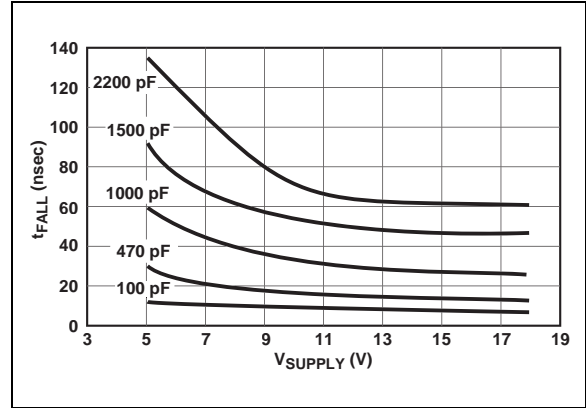

FIGURE 2-4: Fall Time vs. Supply Voltage.

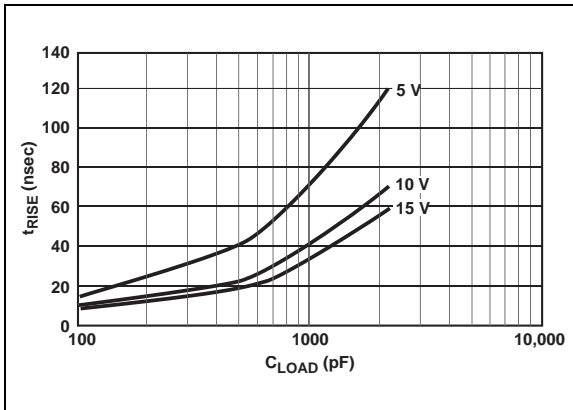

FIGURE 2-2: Rise Time vs. Capacitive Load.

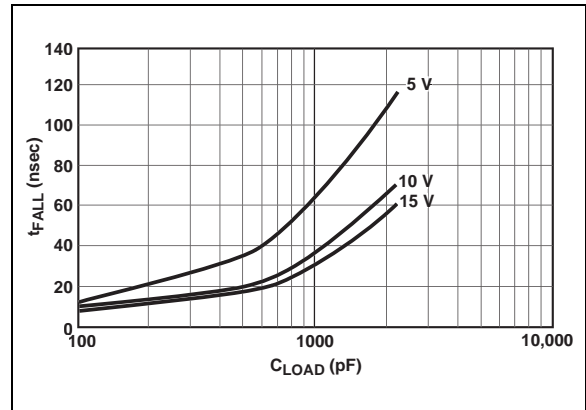

FIGURE 2-5: Fall Time vs. Capacitive Load.

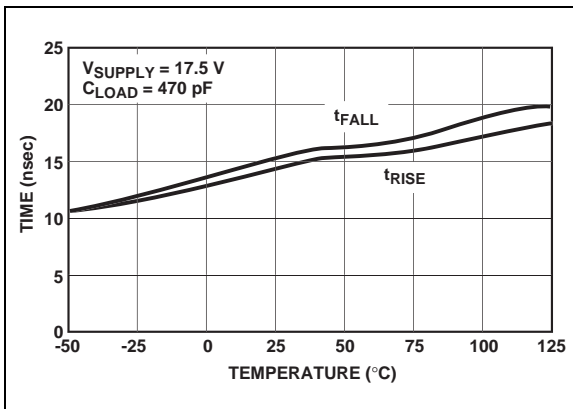

FIGURE 2-3: Rise/Fall Times vs. Temperature.

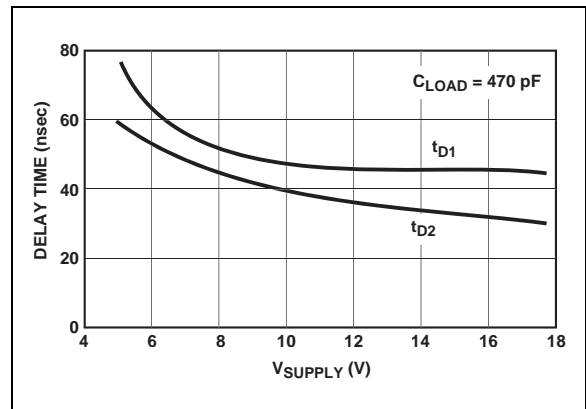

FIGURE 2-6: Propagation Delay Time vs. Supply Voltage.

TC4467/TC4468/TC4469

2.0 TYPICAL PERFORMANCE CURVES (CONTINUED)

Note: $T_A = +25^\circ\text{C}$, with $4.5\text{ V} \leq V_{DD} \leq 18\text{ V}$.

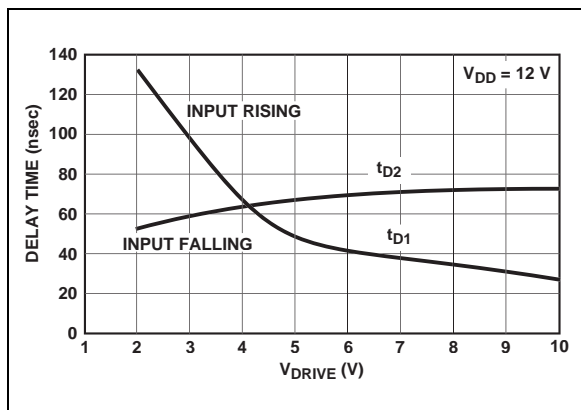

FIGURE 2-7: Input Amplitude vs. Delay Times.

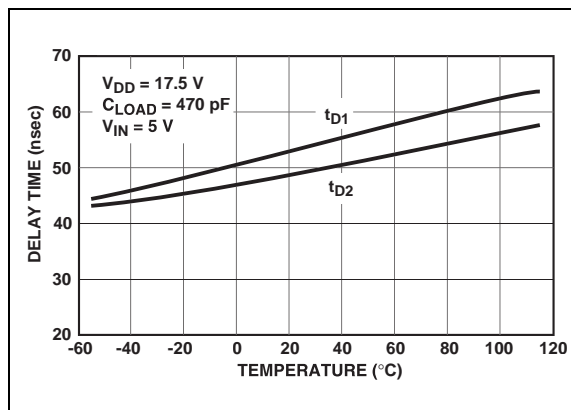

FIGURE 2-10: Propagation Delay Times vs. Temperatures.

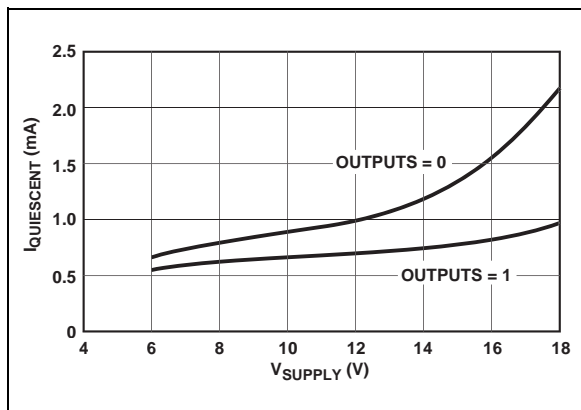

FIGURE 2-8: Quiescent Supply Current vs. Supply Voltage.

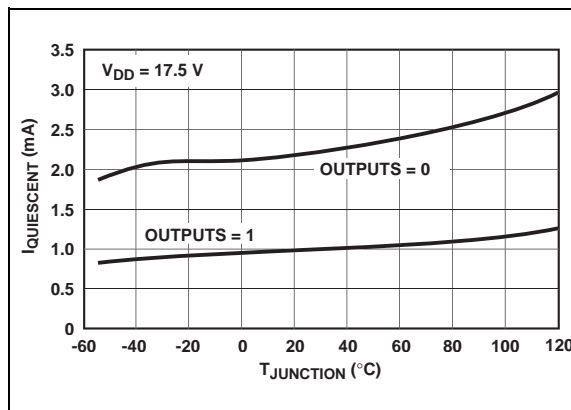

FIGURE 2-11: Quiescent Supply Current vs. Temperature.

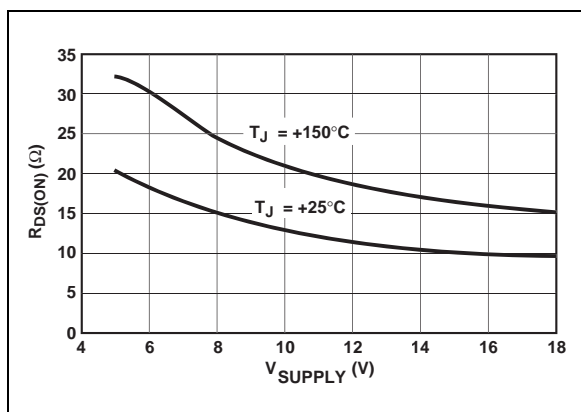

FIGURE 2-9: High-State Output Resistance.

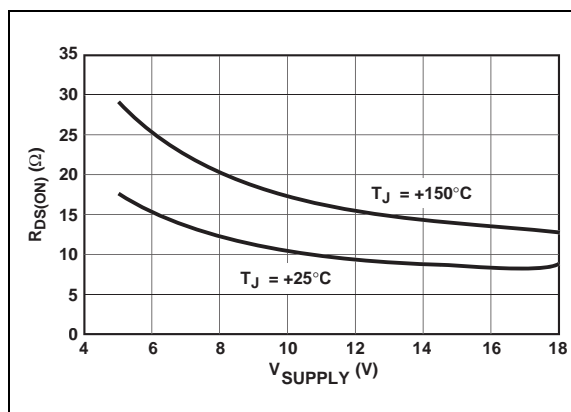

FIGURE 2-12: Low-State Output Resistance.

2.0 TYPICAL PERFORMANCE CURVES (CONTINUED)

Note: (Load on single output only).

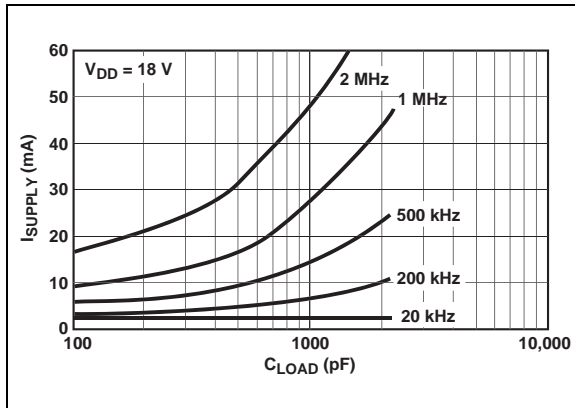

FIGURE 2-13: Supply Current vs. Capacitive Load.

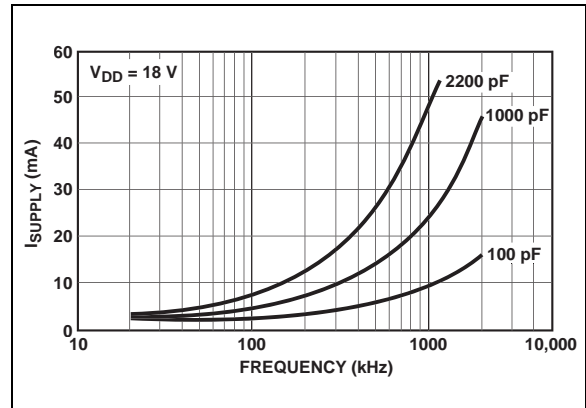

FIGURE 2-16: Supply Current vs. Frequency.

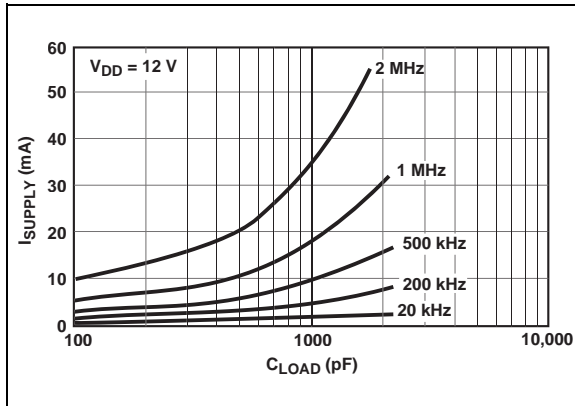

FIGURE 2-14: Supply Current vs. Capacitive Load.

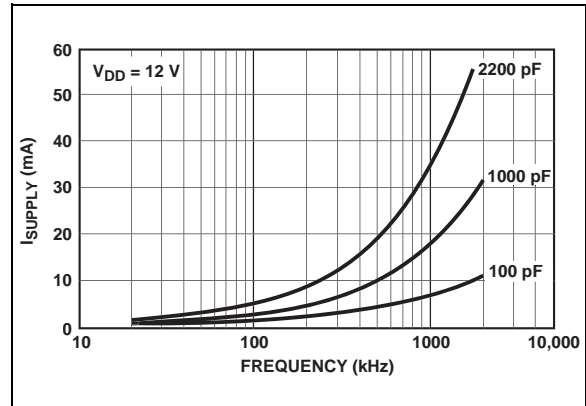

FIGURE 2-17: Supply Current vs. Frequency.

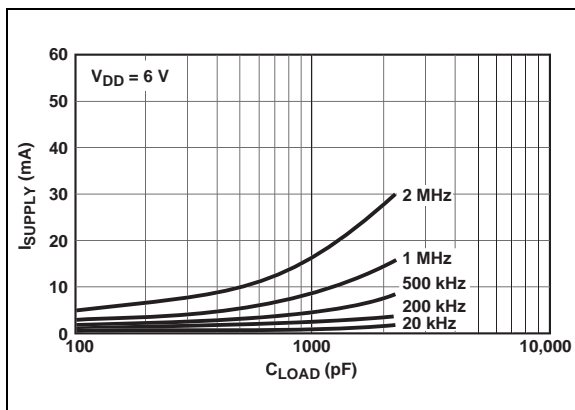

FIGURE 2-15: Supply Current vs. Capacitive Load.

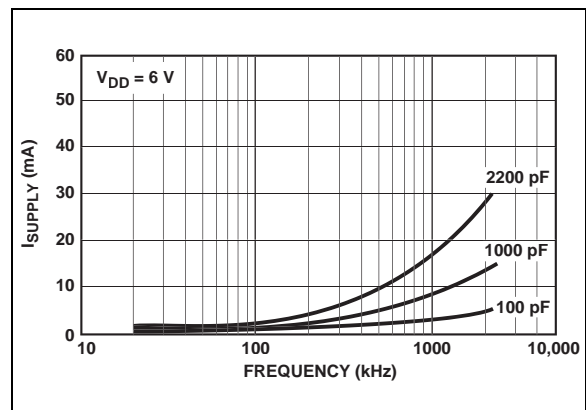

FIGURE 2-18: Supply Current vs. Frequency.

TC4467/TC4468/TC4469

3.0 PIN DESCRIPTIONS

The descriptions of the pins are listed in Table 3-1.

TABLE 3-1: PIN FUNCTION TABLE

14-Pin PDIP, CERDIP	16-Pin SOIC (Wide)	Description
Symbol	Symbol	
1A	1A	Input A for Driver 1, TTL/CMOS Compatible Input
1B	1B	Input B for Driver 1, TTL/CMOS Compatible Input
2A	2A	Input A for Driver 2, TTL/CMOS Compatible Input
2B	2B	Input B for Driver 2, TTL/CMOS Compatible Input
3A	3A	Input A for Driver 3, TTL/CMOS Compatible Input
3B	3B	Input B for Driver 3, TTL/CMOS Compatible Input
GND	GND	Ground
—	GND	Ground
4A	4A	Input A for Driver 4, TTL/CMOS Compatible Input
4B	4B	Input B for Driver 4, TTL/CMOS Compatible Input
4Y	4Y	Output for Driver 4, CMOS Push-Pull Output
3Y	3Y	Output for Driver 3, CMOS Push-Pull Output
2Y	2Y	Output for Driver 2, CMOS Push-Pull Output
1Y	1Y	Output for Driver 1, CMOS Push-Pull Output
V _{DD}	V _{DD}	Supply Input, 4.5 V to 18 V
—	V _{DD}	Supply Input, 4.5 V to 18 V

4.0 DETAILED DESCRIPTION

4.1 Supply Bypassing

Large currents are required to charge and discharge large capacitive loads quickly. For example, charging a 1000 pF load to 18 V in 25 nsec requires 0.72 A from the device's power supply.

To ensure low supply impedance over a wide frequency range, a 1 μ F film capacitor in parallel with one or two low-inductance, 0.1 μ F ceramic disk capacitors with short lead lengths (<0.5 in.) normally provide adequate bypassing.

4.2 Grounding

The TC4467 and TC4469 contain inverting drivers. Potential drops developed in common ground impedances from input to output will appear as negative feedback and degrade switching speed characteristics. Instead, individual ground returns for input and output circuits, or a ground plane, should be used.

4.3 Input Stage

The input voltage level changes the no-load or quiescent supply current. The N-channel MOSFET input stage transistor drives a 2.5 mA current source load. With logic "0" outputs, maximum quiescent supply current is 4 mA. Logic "1" output level signals reduce quiescent current to 1.4 mA, maximum. Unused driver inputs must be connected to V_{DD} or V_{SS} . Minimum power dissipation occurs for logic "1" outputs.

The drivers are designed with 50 mV of hysteresis, which provides clean transitions and minimizes output stage current spiking when changing states. Input voltage thresholds are approximately 1.5 V, making any voltage greater than 1.5 V, up to V_{DD} , a logic "1" input. Input current is less than 1 μ A over this range.

4.4 Power Dissipation

The supply current versus frequency and supply current versus capacitive load characteristic curves will aid in determining power dissipation calculations. Microchip Technology's CMOS drivers have greatly reduced quiescent DC power consumption.

Input signal duty cycle, power supply voltage and load type influence package power dissipation. Given power dissipation and package thermal resistance, the maximum ambient operating temperature is easily calculated. The 14-pin plastic package junction-to-ambient thermal resistance is 83.3°C/W. At +70°C, the package is rated at 800 mW maximum dissipation. Maximum allowable chip temperature is +150°C.

Three components make up total package power dissipation:

1. Load-caused dissipation (P_L).
2. Quiescent power (P_Q).
3. Transition power (P_T).

A capacitive-load-caused dissipation (driving MOSFET gates), is a direct function of frequency, capacitive load and supply voltage. The power dissipation is:

EQUATION

$$P_L = fCV_S^2$$

f = Switching Frequency
 C = Capacitive Load
 V_S = Supply Voltage

A resistive-load-caused dissipation for ground-referenced loads is a function of duty cycle, load current and load voltage. The power dissipation is:

EQUATION

$$P_L = D(V_S - V_L)I_L$$

D = Duty Cycle
 V_S = Supply Voltage
 V_L = Load Voltage
 I_L = Load Current

TC4467/TC4468/TC4469

A resistive-load-caused dissipation for supply-referenced loads is a function of duty cycle, load current and output voltage. The power dissipation is

EQUATION

$$P_L = DV_O I_L$$

D = Duty Cycle
 V_O = Device Output Voltage
 I_L = Load Current

Quiescent power dissipation depends on input signal duty cycle. Logic HIGH outputs result in a lower power dissipation mode, with only 0.6 mA total current drain (all devices driven). Logic LOW outputs raise the current to 4 mA maximum. The quiescent power dissipation is:

EQUATION

$$P_Q = V_S(D(I_H) + (1 - D)I_L)$$

I_H = Quiescent Current with all outputs LOW
 (4 mA max.)
 I_L = Quiescent Current with all outputs HIGH
 (0.6 mA max.)
 D = Duty Cycle
 V_S = Supply Voltage

Transition power dissipation arises in the complimentary configuration (TC446X) because the output stage N-channel and P-channel MOS transistors are ON simultaneously for a very short period when the output changes. The transition power dissipation is approximately:

EQUATION

$$P_T = fV_S(10 \times 10^{-9})$$

$C = 1000 \text{ pF}$ Capacitive Load
 $V_S = 15 \text{ V}$
 $D = 50\%$
 $f = 200 \text{ kHz}$
 $P_D = \text{Package Power Dissipation}$
 $= P_L + P_Q + P_T$
 $= 45 \text{ mW} + 35 \text{ mW} + 30 \text{ mW}$
 $= 110 \text{ mW}$

Package power dissipation is the sum of load, quiescent and transition power dissipations. An example shows the relative magnitude for each term:

Maximum operating temperature is:

EQUATION

$$T_J - \theta_{JA}(P_D) = 141^\circ\text{C}$$

T_J = Maximum allowable junction temperature
 (+150°C)
 θ_{JA} = Junction-to-ambient thermal resistance
 (83.3°C/W) 14-pin plastic package

Note: Ambient operating temperature should not exceed +85°C for "EJD" device or +125°C for "MJD" device.

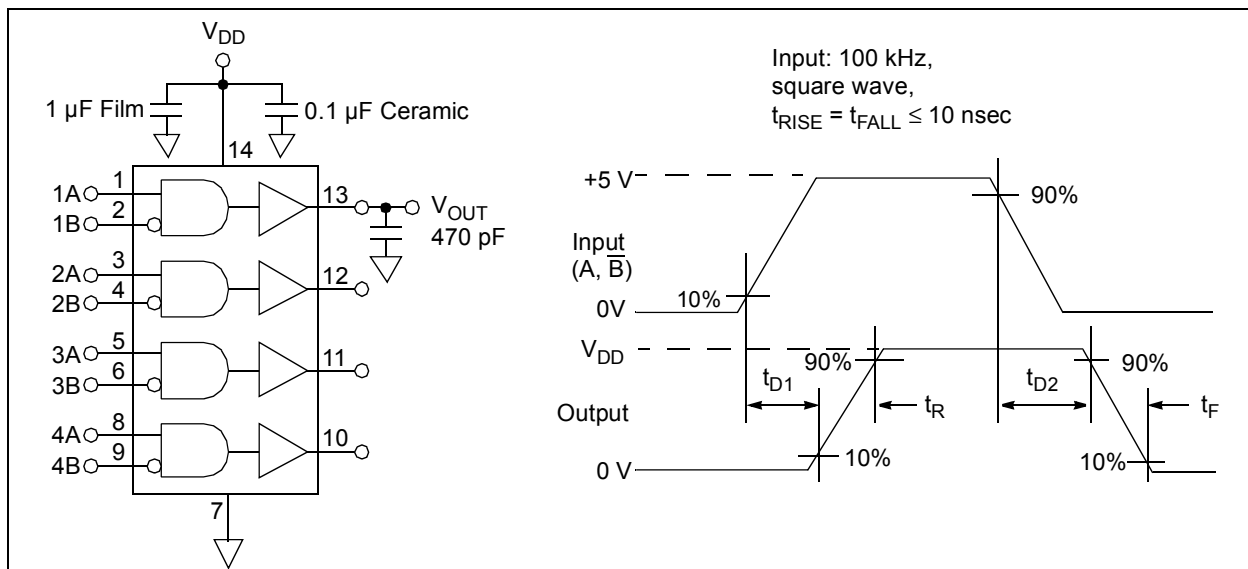

FIGURE 4-1: Switching Time Test Circuit.

5.0 APPLICATIONS INFORMATION

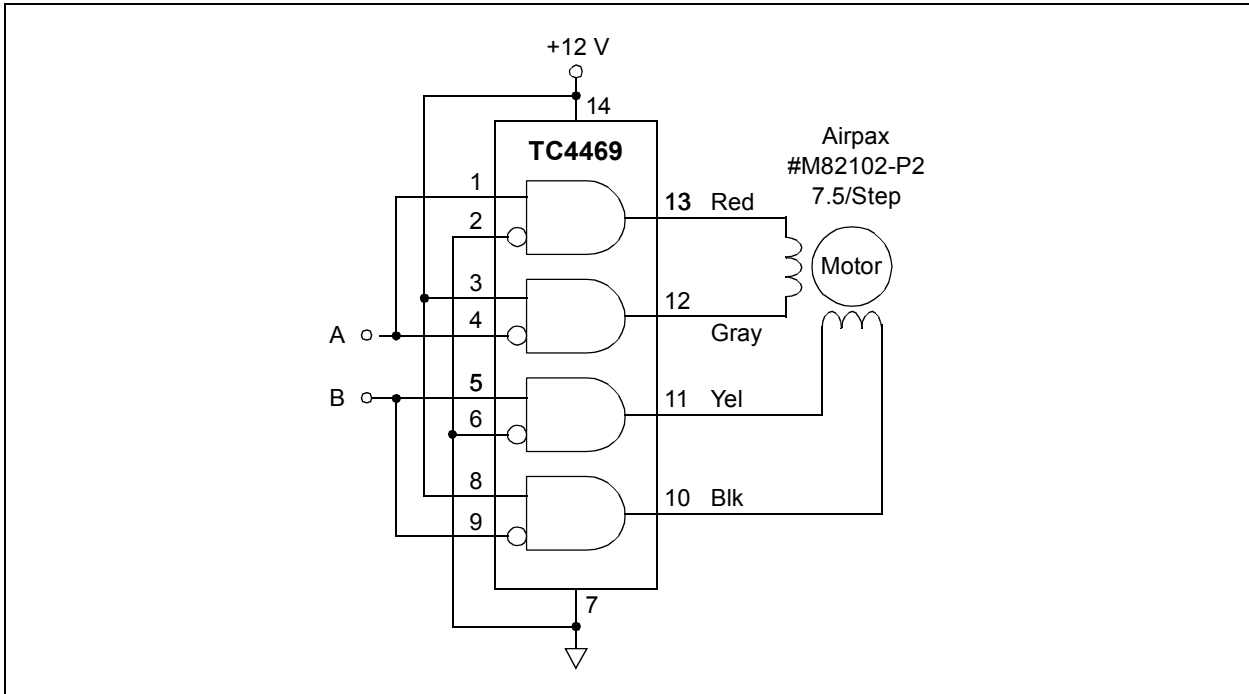

FIGURE 5-1: Stepper Motor Drive.

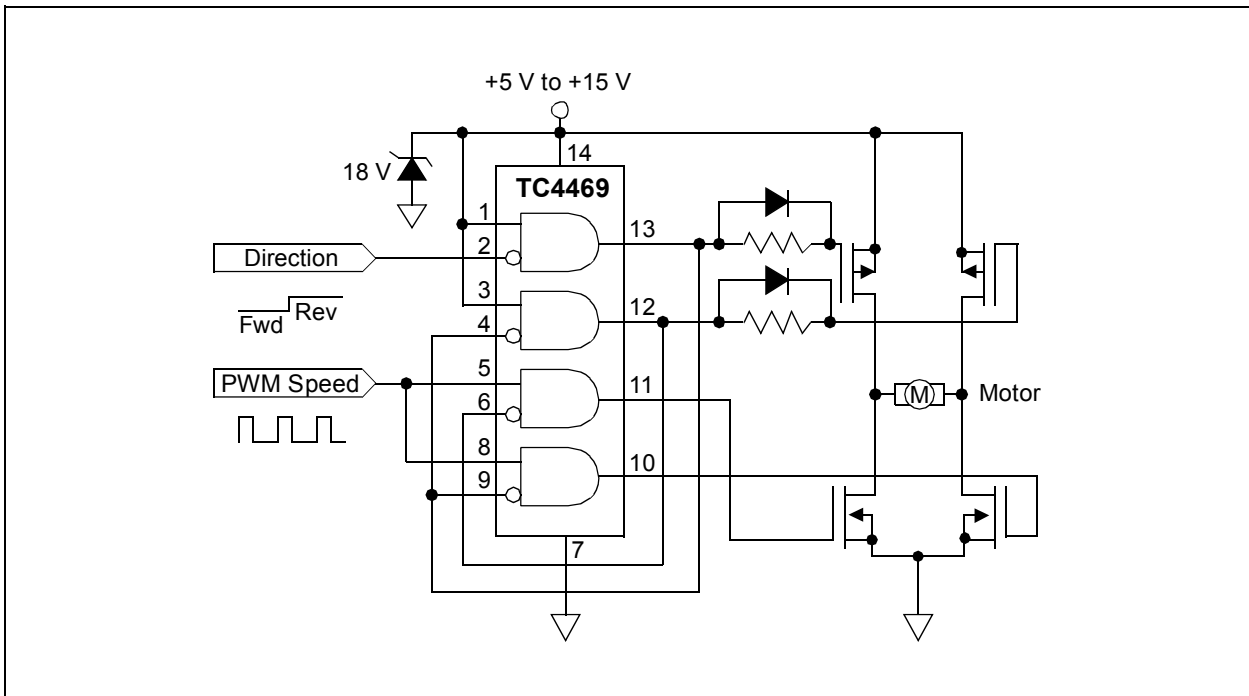

FIGURE 5-2: Quad Driver For H-bridge Motor Control.

TC4467/TC4468/TC4469

6.0 PACKAGING INFORMATION

6.1 Package Marking Information

14-Lead PDIP (300 mil)

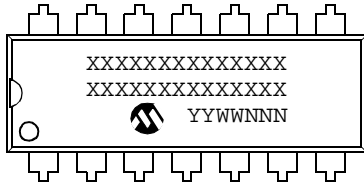

Example:

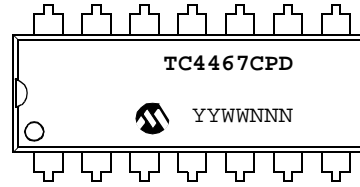

14-Lead CERDIP (300 mil)

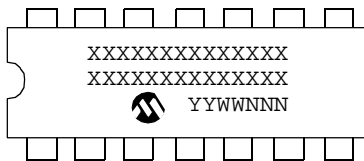

Example:

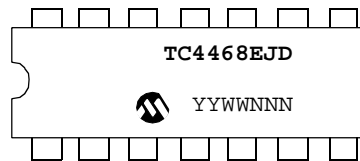

16-Lead SOIC (300 mil)

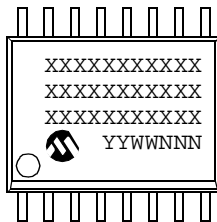

Example:

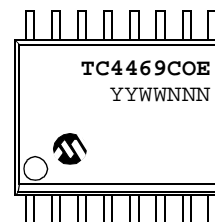

Legend:	XX...X	Customer specific information*
	YY	Year code (last 2 digits of calendar year)
	WW	Week code (week of January 1 is week '01')
	NNN	Alphanumeric traceability code
Note:	In the event the full Microchip part number cannot be marked on one line, it will be carried over to the next line thus limiting the number of available characters for customer specific information.	

* Standard OTP marking consists of Microchip part number, year code, week code, facility code, mask rev#, and assembly code.

TC4467/TC4468/TC4469

14-Lead Plastic Dual In-line (P) – 300 mil (PDIP)

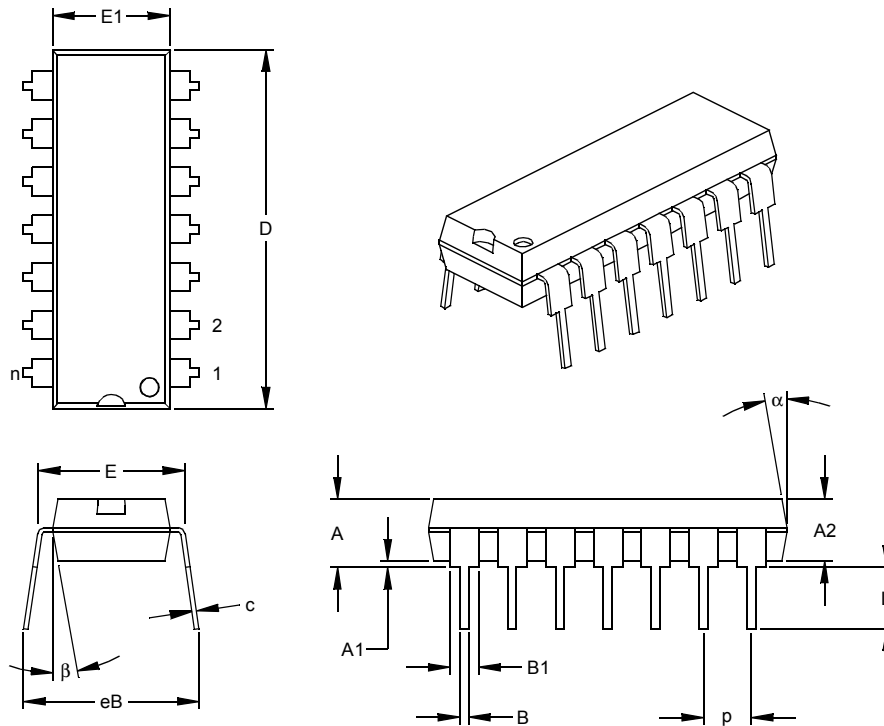

Units		INCHES*			MILLIMETERS		
Dimension Limits		MIN	NOM	MAX	MIN	NOM	MAX
Number of Pins	n		14			14	
Pitch	p		.100			2.54	
Top to Seating Plane	A	.140	.155	.170	3.56	3.94	4.32
Molded Package Thickness	A2	.115	.130	.145	2.92	3.30	3.68
Base to Seating Plane	A1	.015			0.38		
Shoulder to Shoulder Width	E	.300	.313	.325	7.62	7.94	8.26
Molded Package Width	E1	.240	.250	.260	6.10	6.35	6.60
Overall Length	D	.740	.750	.760	18.80	19.05	19.30
Tip to Seating Plane	L	.125	.130	.135	3.18	3.30	3.43
Lead Thickness	c	.008	.012	.015	0.20	0.29	0.38
Upper Lead Width	B1	.045	.058	.070	1.14	1.46	1.78
Lower Lead Width	B	.014	.018	.022	0.36	0.46	0.56
Overall Row Spacing	§ eB	.310	.370	.430	7.87	9.40	10.92
Mold Draft Angle Top	α	5	10	15	5	10	15
Mold Draft Angle Bottom	β	5	10	15	5	10	15

* Controlling Parameter

§ Significant Characteristic

Notes:

Dimensions D and E1 do not include mold flash or protrusions. Mold flash or protrusions shall not exceed .010" (0.254mm) per side.

JEDEC Equivalent: MS-001

Drawing No. C04-005

TC4467/TC4468/TC4469

14-Lead Ceramic Dual In-line – 300 mil (CERDIP)

14-Pin CERDIP (Narrow)

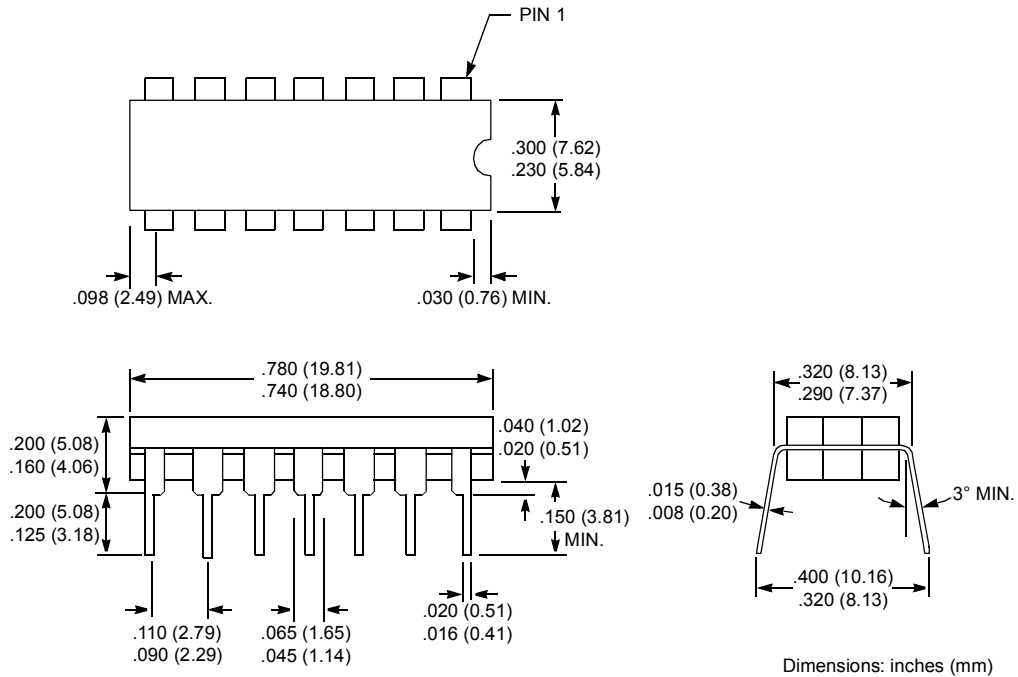

TC4467/TC4468/TC4469

16-Lead Plastic Small Outline (SO) – Wide, 300 mil (SOIC)

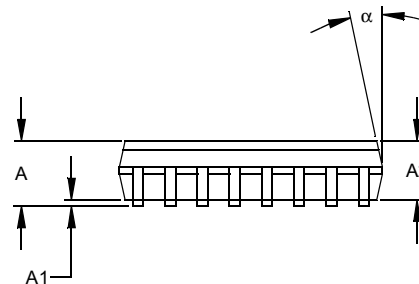
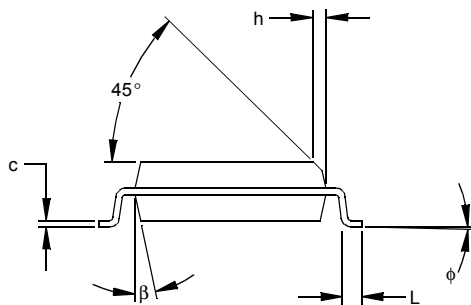
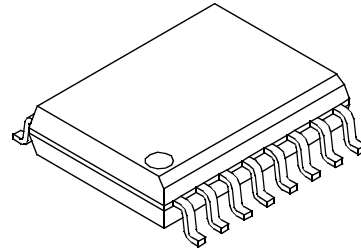
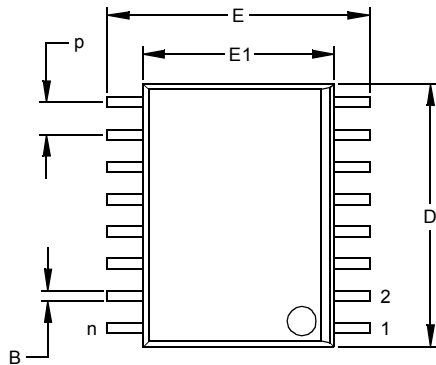

Units		INCHES*			MILLIMETERS		
Dimension Limits		MIN	NOM	MAX	MIN	NOM	MAX
Number of Pins	n		16			16	
Pitch	p		.050			1.27	
Overall Height	A	.093	.099	.104	2.36	2.50	2.64
Molded Package Thickness	A2	.088	.091	.094	2.24	2.31	2.39
Standoff §	A1	.004	.008	.012	0.10	0.20	0.30
Overall Width	E	.394	.407	.420	10.01	10.34	10.67
Molded Package Width	E1	.291	.295	.299	7.39	7.49	7.59
Overall Length	D	.398	.406	.413	10.10	10.30	10.49
Chamfer Distance	h	.010	.020	.029	0.25	0.50	0.74
Foot Length	L	.016	.033	.050	0.41	0.84	1.27
Foot Angle	φ	0	4	8	0	4	8
Lead Thickness	c	.009	.011	.013	0.23	0.28	0.33
Lead Width	B	.014	.017	.020	0.36	0.42	0.51
Mold Draft Angle Top	α	0	12	15	0	12	15
Mold Draft Angle Bottom	β	0	12	15	0	12	15

* Controlling Parameter
§ Significant Characteristic

Notes:

Dimensions D and E1 do not include mold flash or protrusions. Mold flash or protrusions shall not exceed .010" (0.254mm) per side.

JEDEC Equivalent: MS-013

Drawing No. C04-102

TC4467/TC4468/TC4469

NOTES:

ON-LINE SUPPORT

Microchip provides on-line support on the Microchip World Wide Web (WWW) site.

The web site is used by Microchip as a means to make files and information easily available to customers. To view the site, the user must have access to the Internet and a web browser, such as Netscape or Microsoft Explorer. Files are also available for FTP download from our FTP site.

Connecting to the Microchip Internet Web Site

The Microchip web site is available by using your favorite Internet browser to attach to:

www.microchip.com

The file transfer site is available by using an FTP service to connect to:

<ftp://ftp.microchip.com>

The web site and file transfer site provide a variety of services. Users may download files for the latest Development Tools, Data Sheets, Application Notes, User's Guides, Articles and Sample Programs. A variety of Microchip specific business information is also available, including listings of Microchip sales offices, distributors and factory representatives. Other data available for consideration is:

- Latest Microchip Press Releases
- Technical Support Section with Frequently Asked Questions
- Design Tips
- Device Errata
- Job Postings
- Microchip Consultant Program Member Listing
- Links to other useful web sites related to Microchip Products
- Conferences for products, Development Systems, technical information and more
- Listing of seminars and events

Systems Information and Upgrade Hot Line

The Systems Information and Upgrade Line provides system users a listing of the latest versions of all of Microchip's development systems software products. Plus, this line provides information on how customers can receive any currently available upgrade kits. The Hot Line Numbers are:

1-800-755-2345 for U.S. and most of Canada, and

1-480-792-7302 for the rest of the world.

013001

TC4467/TC4468/TC4469

READER RESPONSE

It is our intention to provide you with the best documentation possible to ensure successful use of your Microchip product. If you wish to provide your comments on organization, clarity, subject matter, and ways in which our documentation can better serve you, please FAX your comments to the Technical Publications Manager at (480) 792-4150.

Please list the following information, and use this outline to provide us with your comments about this Data Sheet.

To: Technical Publications Manager Total Pages Sent
RE: Reader Response
From: Name _____
Company _____
Address _____
City / State / ZIP / Country _____
Telephone: (_____) _____ - _____ FAX: (_____) _____ - _____

Application (optional):

Would you like a reply? ___Y ___N

Device: **TC4467/TC4468/TC4469** Literature Number: **DS21425B**

Questions:

1. What are the best features of this document?

2. How does this document meet your hardware and software development needs?

3. Do you find the organization of this data sheet easy to follow? If not, why?

4. What additions to the data sheet do you think would enhance the structure and subject?

5. What deletions from the data sheet could be made without affecting the overall usefulness?

6. Is there any incorrect or misleading information (what and where)?

7. How would you improve this document?

8. How would you improve our software, systems, and silicon products?

TC4467/TC4468/TC4469

PRODUCT IDENTIFICATION SYSTEM

To order or obtain information, e.g., on pricing or delivery, refer to the factory or the listed sales office.

<u>PART NO.</u>	<u>X</u>	<u>XX</u>
Device	Temperature Range	Package
Device:	TC4467: 1.2A Quad MOSFET Driver, NAND TC4468: 1.2A Quad MOSFET Driver, AND TC4469: 1.2A Quad MOSFET Driver, AND/INV	
Temperature Range:	C = 0°C to +70°C E = -40°C to +85°C (CERDIP only) M = -55°C to +125°C (CERDIP only)	
Package:	PD = Plastic DIP, (300 mil body), 14-lead JD = Ceramic DIP, (300 mil body), 14-lead OE = SOIC (Wide), 16-lead OE713 = SOIC (Wide), 16-lead (Tape and Reel)	

Examples:

- a) TC4467COE: Commercial Temperature, SOIC package.
- b) TC4467CPD: Commercial Temperature, PDIP package.
- c) TC4467MJD: Military Temperature, Ceramic DIP package.

- a) TC4468COE713: Tape and Reel, Commercial Temp., SOIC package.
- b) TC4468CPD: Commercial Temperature, PDIP package.

- a) TC4469COE: Commercial Temperature, SOIC package.
- b) TC4469CPD: Commercial Temperature, PDIP package.

Sales and Support

Data Sheets

Products supported by a preliminary Data Sheet may have an errata sheet describing minor operational differences and recommended workarounds. To determine if an errata sheet exists for a particular device, please contact one of the following:

1. Your local Microchip sales office
2. The Microchip Corporate Literature Center U.S. FAX: (480) 792-7277
3. The Microchip Worldwide Site (www.microchip.com)

Please specify which device, revision of silicon and Data Sheet (include Literature #) you are using.

New Customer Notification System

Register on our web site (www.microchip.com/cn) to receive the most current information on our products.

TC4467/TC4468/TC4469

NOTES:

Information contained in this publication regarding device applications and the like is intended through suggestion only and may be superseded by updates. It is your responsibility to ensure that your application meets with your specifications. No representation or warranty is given and no liability is assumed by Microchip Technology Incorporated with respect to the accuracy or use of such information, or infringement of patents or other intellectual property rights arising from such use or otherwise. Use of Microchip's products as critical components in life support systems is not authorized except with express written approval by Microchip. No licenses are conveyed, implicitly or otherwise, under any intellectual property rights.

Trademarks

The Microchip name and logo, the Microchip logo, FilterLab, KEELOQ, microID, MPLAB, MXDEV, PIC, PICmicro, PICMASTER, PICSTART, PRO MATE, SEEVAL and The Embedded Control Solutions Company are registered trademarks of Microchip Technology Incorporated in the U.S.A. and other countries.

dsPIC, dsPICDEM.net, ECONOMONITOR, FanSense, FlexROM, fuzzyLAB, In-Circuit Serial Programming, ICSP, ICEPIC, microPort, Migratable Memory, MPASM, MPLIB, MPLINK, MPSIM, MXLAB, PICC, PICDEM, PICDEM.net, rfPIC, Select Mode and Total Endurance are trademarks of Microchip Technology Incorporated in the U.S.A.

Serialized Quick Turn Programming (SQTP) is a service mark of Microchip Technology Incorporated in the U.S.A.

All other trademarks mentioned herein are property of their respective companies.

© 2002, Microchip Technology Incorporated, Printed in the U.S.A., All Rights Reserved.

 Printed on recycled paper.

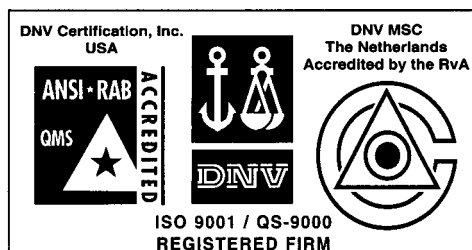

Microchip received QS-9000 quality system certification for its worldwide headquarters, design and wafer fabrication facilities in Chandler and Tempe, Arizona in July 1999 and Mountain View, California in March 2002. The Company's quality system processes and procedures are QS-9000 compliant for its PICmicro® 8-bit MCUs, KEELOQ® code hopping devices, Serial EEPROMs, microperipherals, non-volatile memory and analog products. In addition, Microchip's quality system for the design and manufacture of development systems is ISO 9001 certified.



MICROCHIP

WORLDWIDE SALES AND SERVICE

AMERICAS

Corporate Office

2355 West Chandler Blvd.
Chandler, AZ 85224-6199
Tel: 480-792-7200 Fax: 480-792-7277
Technical Support: 480-792-7627
Web Address: <http://www.microchip.com>

Rocky Mountain

2355 West Chandler Blvd.
Chandler, AZ 85224-6199
Tel: 480-692-7966 Fax: 480-792-4338

Atlanta

500 Sugar Mill Road, Suite 200B
Atlanta, GA 30350
Tel: 770-640-0034 Fax: 770-640-0307

Boston

2 Lan Drive, Suite 120
Westford, MA 01886
Tel: 978-692-3848 Fax: 978-692-3821

Chicago

333 Pierce Road, Suite 180
Itasca, IL 60143
Tel: 630-285-0071 Fax: 630-285-0075

Dallas

4570 Westgrove Drive, Suite 160
Addison, TX 75001
Tel: 972-818-7423 Fax: 972-818-2924

Detroit

Tri-Atria Office Building
32255 Northwestern Highway, Suite 190
Farmington Hills, MI 48334
Tel: 248-538-2250 Fax: 248-538-2260

Kokomo

2767 S. Albright Road
Kokomo, Indiana 46902
Tel: 765-864-8360 Fax: 765-864-8387

Los Angeles

18201 Von Karman, Suite 1090
Irvine, CA 92612
Tel: 949-263-1888 Fax: 949-263-1338

New York

150 Motor Parkway, Suite 202
Hauppauge, NY 11788
Tel: 631-273-5305 Fax: 631-273-5335

San Jose

Microchip Technology Inc.
2107 North First Street, Suite 590
San Jose, CA 95131
Tel: 408-436-7950 Fax: 408-436-7955

Toronto

6285 Northam Drive, Suite 108
Mississauga, Ontario L4V 1X5, Canada
Tel: 905-673-0699 Fax: 905-673-6509

ASIA/PACIFIC

Australia

Microchip Technology Australia Pty Ltd
Suite 22, 41 Rawson Street
Epping 2121, NSW
Australia
Tel: 61-2-9868-6733 Fax: 61-2-9868-6755

China - Beijing

Microchip Technology Consulting (Shanghai)
Co., Ltd., Beijing Liaison Office
Unit 915
Bei Hai Wan Tai Bldg.
No. 6 Chaoyangmen Beidajie
Beijing, 100027, No. China
Tel: 86-10-85282100 Fax: 86-10-85282104

China - Chengdu

Microchip Technology Consulting (Shanghai)
Co., Ltd., Chengdu Liaison Office
Rm. 2401, 24th Floor,
Ming Xing Financial Tower
No. 88 TIDU Street
Chengdu 610016, China
Tel: 86-28-86766200 Fax: 86-28-86766599

China - Fuzhou

Microchip Technology Consulting (Shanghai)
Co., Ltd., Fuzhou Liaison Office
Unit 28F, World Trade Plaza
No. 71 Wusi Road
Fuzhou 350001, China
Tel: 86-591-7503506 Fax: 86-591-7503521

China - Shanghai

Microchip Technology Consulting (Shanghai)
Co., Ltd.
Room 701, Bldg. B
Far East International Plaza
No. 317 Xian Xia Road
Shanghai, 200051
Tel: 86-21-6275-5700 Fax: 86-21-6275-5060

China - Shenzhen

Microchip Technology Consulting (Shanghai)
Co., Ltd., Shenzhen Liaison Office
Rm. 1315, 13/F, Shenzhen Kerry Centre,
Renminnan Lu
Shenzhen 518001, China
Tel: 86-755-2350361 Fax: 86-755-2366086

China - Hong Kong SAR

Microchip Technology Hongkong Ltd.
Unit 901-6, Tower 2, Metroplaza
223 Hing Fong Road
Kwai Fong, N.T., Hong Kong
Tel: 852-2401-1200 Fax: 852-2401-3431

India

Microchip Technology Inc.
India Liaison Office
Divyasree Chambers
1 Floor, Wing A (A3/A4)
No. 11, O'Shaughnessey Road
Bangalore, 560 025, India
Tel: 91-80-2290061 Fax: 91-80-2290062

Japan

Microchip Technology Japan K.K.
Benex S-1 6F
3-18-20, Shinyokohama
Kohoku-Ku, Yokohama-shi
Kanagawa, 222-0033, Japan
Tel: 81-45-471-6166 Fax: 81-45-471-6122

Korea

Microchip Technology Korea
168-1, Youngbo Bldg. 3 Floor
Samsung-Dong, Kangnam-Ku
Seoul, Korea 135-882
Tel: 82-2-554-7200 Fax: 82-2-558-5934

Singapore

Microchip Technology Singapore Pte Ltd.
200 Middle Road
#07-02 Prime Centre
Singapore, 188980
Tel: 65-6334-8870 Fax: 65-6334-8850

Taiwan

Microchip Technology (Barbados) Inc.,
Taiwan Branch
11F-3, No. 207
Tung Hua North Road
Taipei, 105, Taiwan
Tel: 886-2-2717-7175 Fax: 886-2-2545-0139

EUROPE

Denmark

Microchip Technology Nordic ApS
Regus Business Centre
Lautrup høj 1-3
Ballerup DK-2750 Denmark
Tel: 45 4420 9895 Fax: 45 4420 9910

France

Microchip Technology SARL
Parc d'Activite du Moulin de Massy
43 Rue du Saule Trapu
Batiment A - 1er Etage
91300 Massy, France
Tel: 33-1-69-53-63-20 Fax: 33-1-69-30-90-79

Germany

Microchip Technology GmbH
Gustav-Heinemann Ring 125
D-81739 Munich, Germany
Tel: 49-89-627-144 0 Fax: 49-89-627-144-44

Italy

Microchip Technology SRL
Centro Direzionale Colleoni
Palazzo Taurus 1 V. Le Colleoni 1
20041 Agrate Brianza
Milan, Italy
Tel: 39-039-65791-1 Fax: 39-039-6899883

United Kingdom

Microchip Ltd.
505 Eskdale Road
Winnersh Triangle
Wokingham
Berkshire, England RG41 5TU
Tel: 44 118 921 5869 Fax: 44-118 921-5820

Austria

Microchip Technology Austria GmbH
Durisolstrasse 2
A-4600 Wels
Austria
Tel: 43-7242-2244-399
Fax: 43-7242-2244-393

05/16/02