

10MHz, 6V/ μ s, Dual/Quad Rail-to-Rail Input and Output Precision C-Load Op Amps

FEATURES

- Rail-to-Rail Input and Output
- 475 μ V Max V_{OS} from V^+ to V^-
- Gain-Bandwidth Product: 10MHz
- Slew Rate: 6V/ μ s
- Low Supply Current per Amplifier: 1.7mA
- Input Offset Current: 50nA Max
- Input Bias Current: 500nA Max
- Open-Loop Gain: 1000V/mV Min
- Low Input Noise Voltage: 12nV/ $\sqrt{\text{Hz}}$ Typ
- Wide Supply Range: 2.2V to ± 15 V
- Large Output Drive Current: 30mA
- Stable for Capacitive Loads Up to 10,000pF
- Dual in 8-Pin PDIP and SO Package
- Quad in Narrow 14-Pin SO

APPLICATIONS

- Driving A-to-D Converters
- Active Filters
- Rail-to-Rail Buffer Amplifiers
- Low Voltage Signal Processing
- Battery-Powered Systems

 LTC and LT are registered trademarks of Linear Technology Corporation.
 C-Load is a trademark of Linear Technology Corporation.

DESCRIPTION

The LT[®]1498/LT1499 are dual/quad, rail-to-rail input and output precision C-Load[™] op amps with a 10MHz gain-bandwidth product and a 6V/ μ s slew rate.

The LT1498/LT1499 are designed to maximize input dynamic range by delivering precision performance over the full supply voltage. Using a patented technique, both input stages of the LT1498/LT1499 are trimmed, one at the negative supply and the other at the positive supply. The resulting guaranteed common mode rejection is much better than other rail-to-rail input op amps. When used as a unity-gain buffer in front of single supply 12-bit A-to-D converters, the LT1498/LT1499 are guaranteed to add less than 1LSB of error even in single 3V supply systems.

With 110dB of supply rejection, the LT1498/LT1499 maintain their performance over a supply range of 2.2V to 36V and are specified for 3V, 5V and ± 15 V supplies. The inputs can be driven beyond the supplies without damage or phase reversal of the output. These op amps remain stable while driving capacitive loads up to 10,000pF.

The LT1498 is available with the standard dual op amp configuration in 8-pin PDIP and SO packaging. The LT1499 features the standard quad op amp configuration and is available in a 14-pin plastic SO package. These devices can be used as plug-in replacements for many standard op amps to improve input/output range and precision.

TYPICAL APPLICATION

Single Supply 100kHz 4th Order Butterworth Filter

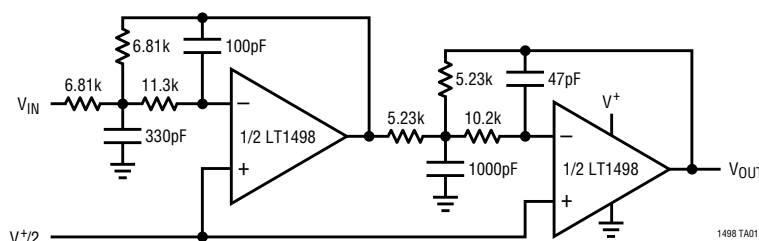

Frequency Response

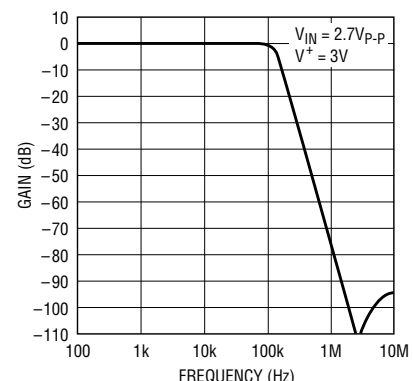

ABSOLUTE MAXIMUM RATINGS

Total Supply Voltage (V^+ to V^-)	36V	Specified Temperature Range (Note 3)	-40°C to 85°C
Input Current	$\pm 10\text{mA}$	Junction Temperature	150°C
Output Short-Circuit Duration (Note 1)	Continuous	Storage Temperature Range	-65°C to 150°C
Operating Temperature Range	-40°C to 85°C	Lead Temperature (Soldering, 10 sec)	300°C

PACKAGE/ORDER INFORMATION

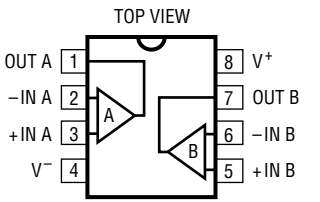
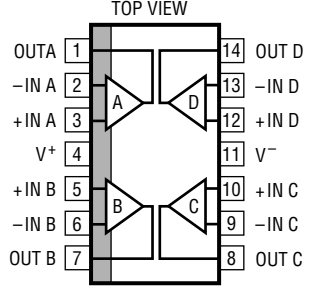
 <p>TOP VIEW</p> <p>OUT A [1] [8] V^+ -IN A [2] [7] OUT B +IN A [3] [6] -IN B V^- [4] [5] +IN B</p> <p>N8 PACKAGE S8 PACKAGE 8-LEAD PDIP 8-LEAD PLASTIC SO</p> <p>$T_{JMAX} = 150^{\circ}\text{C}$, $\theta_{JA} = 130^{\circ}\text{C/W}$ (N8) $T_{JMAX} = 150^{\circ}\text{C}$, $\theta_{JA} = 190^{\circ}\text{C/W}$ (S8)</p>	ORDER PART NUMBER	 <p>TOP VIEW</p> <p>OUT A [1] [14] OUT D -IN A [2] [13] -IN D +IN A [3] [12] +IN D V^+ [4] [11] V^- +IN B [5] [10] +IN C -IN B [6] [9] -IN C OUT B [7] [8] OUT C</p> <p>S PACKAGE 14-LEAD PLASTIC SO</p> <p>$T_{JMAX} = 150^{\circ}\text{C}$, $\theta_{JA} = 150^{\circ}\text{C/W}$</p>	ORDER PART NUMBER
	LT1498CN8 LT1498CS8		LT1499CS
	S8 PART MARKING		
	1498		

Consult factory for Military and Industrial grade parts.

ELECTRICAL CHARACTERISTICS

$T_A = 25^{\circ}\text{C}$, $V_S = 5\text{V}, 0\text{V}$; $V_S = 3\text{V}, 0\text{V}$; $V_{CM} = V_{OUT} = \text{half supply}$, unless otherwise noted.

SYMBOL	PARAMETER	CONDITIONS	MIN	TYP	MAX	UNITS
V_{OS}	Input Offset Voltage	$V_{CM} = V^+$		150	475	μV
		$V_{CM} = V^-$		150	475	μV
ΔV_{OS}	Input Offset Voltage Shift	$V_{CM} = V^-$ to V^+		150	425	μV
		Input Offset Voltage Match (Channel-to-Channel)	$V_{CM} = V^+, V^-$ (Note 4)	200	750	μV
I_B	Input Bias Current	$V_{CM} = V^+$	0	250	500	nA
		$V_{CM} = V^-$	-500	-250	0	nA
ΔI_B	Input Bias Current Shift	$V_{CM} = V^-$ to V^+		500	1000	nA
		Input Bias Current Match (Channel-to-Channel)	$V_{CM} = V^+$ (Note 4) $V_{CM} = V^-$ (Note 4)	0 -100	10 -10	100 0
I_{OS}	Input Offset Current	$V_{CM} = V^+$		5	50	nA
		$V_{CM} = V^-$		5	50	nA
ΔI_{OS}	Input Offset Current Shift	$V_{CM} = V^-$ to V^+		10	100	nA
e_n	Input Noise Voltage Density	0.1Hz to 10Hz		400		nV/ $\sqrt{\text{Hz}}$
i_n	Input Noise Current Density	$f = 1\text{kHz}$		12		nV/ $\sqrt{\text{Hz}}$
i_n	Input Noise Current Density	$f = 1\text{kHz}$		0.3		pA/ $\sqrt{\text{Hz}}$
C_{IN}	Input Capacitance			5		pF
A_{VOL}	Large-Signal Voltage Gain	$V_S = 5\text{V}$, $V_O = 75\text{mV}$ to 4.8V , $R_L = 10\text{k}$	600	3800		V/mV
		$V_S = 3\text{V}$, $V_O = 75\text{mV}$ to 2.8V , $R_L = 10\text{k}$	500	2000		V/mV

ELECTRICAL CHARACTERISTICS

$T_A = 25^\circ\text{C}$, $V_S = 5\text{V}, 0\text{V}$; $V_S = 3\text{V}, 0\text{V}$; $V_{CM} = V_{OUT} = \text{half supply}$, unless otherwise noted.

SYMBOL	PARAMETER	CONDITIONS	MIN	TYP	MAX	UNITS
CMRR	Common Mode Rejection Ratio	$V_S = 5\text{V}, V_{CM} = V^- \text{ to } V^+$	81	90		dB
		$V_S = 3\text{V}, V_{CM} = V^- \text{ to } V^+$	76	86		dB
	CMRR Match (Channel-to-Channel) (Note 4)	$V_S = 5\text{V}, V_{CM} = V^- \text{ to } V^+$	75	91		dB
		$V_S = 3\text{V}, V_{CM} = V^- \text{ to } V^+$	70	86		dB
PSRR	Power Supply Rejection Ratio	$V_S = 2.2\text{V to } 12\text{V}, V_{CM} = V_O = 0.5\text{V}$	88	105		dB
		PSRR Match (Channel-to-Channel) (Note 4)	82	103		dB
V_{OL}	Output Voltage Swing (Low) (Note 5)	No Load		14	30	mV
		$I_{SINK} = 0.5\text{mA}$		35	70	mV
		$I_{SINK} = 2.5\text{mA}$		90	200	mV
V_{OH}	Output Voltage Swing (High) (Note 5)	No Load		2.5	10	mV
		$I_{SOURCE} = 0.5\text{mA}$		50	100	mV
		$I_{SOURCE} = 2.5\text{mA}$		140	250	mV
I_{SC}	Short-Circuit Current	$V_S = 5\text{V}$	± 12.5	± 24		mA
		$V_S = 3\text{V}$	± 12.0	± 19		mA
I_S	Supply Current per Amplifier			1.7	2.2	mA
GBW	Gain-Bandwidth Product (Note 6)		6.8	10.5		MHz
SR	Slew Rate (Note 7)	$V_S = 5\text{V}, A_V = -1, R_L = \text{Open}, V_O = 4\text{V}$	2.6	4.5		V/ μs
		$V_S = 3\text{V}, A_V = -1, R_L = \text{Open}$	2.3	4.0		V/ μs

$0^\circ\text{C} < T_A < 70^\circ\text{C}$, $V_S = 5\text{V}, 0\text{V}$; $V_S = 3\text{V}, 0\text{V}$; $V_{CM} = V_{OUT} = \text{half supply}$, unless otherwise noted.

SYMBOL	PARAMETER	CONDITIONS	MIN	TYP	MAX	UNITS
V_{OS}	Input Offset Voltage	$V_{CM} = V^+$	●	175	650	μV
		$V_{CM} = V^- + 0.1\text{V}$	●	175	650	μV
$V_{OS\ TC}$	Input Offset Voltage Drift (Note 2)	$V_{CM} = V^+$	●	0.5	2.5	$\mu\text{V}/^\circ\text{C}$
		$V_{CM} = V^- + 0.1\text{V}$	●	1.5	4.0	$\mu\text{V}/^\circ\text{C}$
ΔV_{OS}	Input Offset Voltage Shift	$V_{CM} = V^- + 0.1\text{V to } V^+$	●	170	600	μV
	Input Offset Voltage Match (Channel-to-Channel)	$V_{CM} = V^- + 0.1\text{V}, V^+$ (Note 4)	●	200	900	μV
I_B	Input Bias Current	$V_{CM} = V^+$	●	0	275	nA
		$V_{CM} = V^- + 0.1\text{V}$	●	-600	-275	0
ΔI_B	Input Bias Current Shift	$V_{CM} = V^- + 0.1\text{V to } V^+$	●	550	1200	nA
	Input Bias Current Match (Channel-to-Channel)	$V_{CM} = V^+$ (Note 4) $V_{CM} = V^- + 0.1\text{V}$ (Note 4)	● ●	0 -170	15 -15	170 0
I_{OS}	Input Offset Current	$V_{CM} = V^+$	●	10	85	nA
		$V_{CM} = V^- + 0.1\text{V}$	●	10	85	nA
ΔI_{OS}	Input Offset Current Shift	$V_{CM} = V^- + 0.1\text{V to } V^+$	●	20	170	nA
A_{VOL}	Large-Signal Voltage Gain	$V_S = 5\text{V}, V_O = 75\text{mV to } 4.8\text{V}, R_L = 10\text{k}$	●	500	2500	V/mV
		$V_S = 3\text{V}, V_O = 75\text{mV to } 2.8\text{V}, R_L = 10\text{k}$	●	400	2000	V/mV
CMRR	Common Mode Rejection Ratio	$V_S = 5\text{V}, V_{CM} = V^- + 0.1\text{V to } V^+$	●	78	89	dB
		$V_S = 3\text{V}, V_{CM} = V^- + 0.1\text{V to } V^+$	●	73	85	dB
	CMRR Match (Channel-to-Channel) (Note 4)	$V_S = 5\text{V}, V_{CM} = V^- + 0.1\text{V to } V^+$	●	74	90	dB
		$V_S = 3\text{V}, V_{CM} = V^- + 0.1\text{V to } V^+$	●	69	86	dB
PSRR	Power Supply Rejection Ratio	$V_S = 2.3\text{V to } 12\text{V}, V_{CM} = V_O = 0.5\text{V}$	●	86	102	dB
		PSRR Match (Channel-to-Channel) (Note 4)	●	80	102	dB

ELECTRICAL CHARACTERISTICS

0°C < T_A < 70°C, V_S = 5V, 0V; V_S = 3V, 0V; V_{CM} = V_{OUT} = half supply, unless otherwise noted.

SYMBOL	PARAMETER	CONDITIONS	MIN	TYP	MAX	UNITS
V _{OL}	Output Voltage Swing (Low) (Note 5)	No Load		17	35	mV
		I _{SINK} = 0.5mA		40	80	mV
		I _{SINK} = 2.5mA		110	220	mV
V _{OH}	Output Voltage Swing (High) (Note 5)	No Load		3.5	15	mV
		I _{SOURCE} = 0.5mA		55	120	mV
		I _{SOURCE} = 2.5mA		160	300	mV
I _{SC}	Short-Circuit Current	V _S = 5V	±12	±23		mA
		V _S = 3V	±10	±20		mA
I _S	Supply Current per Amplifier			1.9	2.6	mA
GBW	Gain-Bandwidth Product (Note 6)		6.1	9		MHz
SR	Slew Rate (Note 7)	V _S = 5V, A _V = -1, R _L = Open, V _O = 4V		2.5	4.0	V/μs
		V _S = 3V, A _V = -1, R _L = Open		2.2	3.5	V/μs

-40°C < T_A < 85°C, V_S = 5V, 0V; V_S = 3V, 0V; V_{CM} = V_{OUT} = half supply, unless otherwise noted. (Note 3)

SYMBOL	PARAMETER	CONDITIONS	MIN	TYP	MAX	UNITS
V _{OS}	Input Offset Voltage	V _{CM} = V ⁺		250	750	μV
		V _{CM} = V ⁻ + 0.1V		250	750	μV
V _{OS} TC	Input Offset Voltage Drift (Note 2)	V _{CM} = V ⁺		0.5	2.5	μV/°C
		V _{CM} = V ⁻ + 0.1V		1.5	4.0	μV/°C
ΔV _{OS}	Input Offset Voltage Shift	V _{CM} = V ⁻ + 0.1V to V ⁺		250	650	μV
	Input Offset Voltage Match (Channel-to-Channel)	V _{CM} = V ⁻ + 0.1V, V ⁺ (Note 4)		300	1500	μV
I _B	Input Bias Current	V _{CM} = V ⁺	0	350	750	nA
		V _{CM} = V ⁻ + 0.1V	-750	-350	0	nA
ΔI _B	Input Bias Current Shift	V _{CM} = V ⁻ + 0.1V to V ⁺		700	1500	nA
	Input Bias Current Match (Channel-to-Channel)	V _{CM} = V ⁺ (Note 4) V _{CM} = V ⁻ + 0.1V (Note 4)	0 -180	30 -30	180 0	nA nA
I _{OS}	Input Offset Current	V _{CM} = V ⁺		15	90	nA
		V _{CM} = V ⁻ + 0.1V		15	90	nA
ΔI _{OS}	Input Offset Current Shift	V _{CM} = V ⁻ + 0.1V to V ⁺		30	180	nA
A _{VOL}	Large-Signal Voltage Gain	V _S = 5V, V _O = 75mV to 4.8V, R _L = 10k	400	2500		V/mV
		V _S = 3V, V _O = 75mV to 2.8V, R _L = 10k	300	2000		V/mV
CMRR	Common Mode Rejection Ratio	V _S = 5V, V _{CM} = V ⁻ + 0.1V to V ⁺	77	86		dB
		V _S = 3V, V _{CM} = V ⁻ + 0.1V to V ⁺	73	81		dB
CMRR Match (Channel-to-Channel) (Note 4)	CMRR Match (Channel-to-Channel) (Note 4)	V _S = 5V, V _{CM} = V ⁻ + 0.1V to V ⁺	72	86		dB
		V _S = 3V, V _{CM} = V ⁻ + 0.1V to V ⁺	69	83		dB
PSRR	Power Supply Rejection Ratio	V _S = 2.5V to 12V, V _{CM} = V _O = 0.5V	86	100		dB
	PSRR Match (Channel-to-Channel) (Note 4)	V _S = 2.5V to 12V, V _{CM} = V _O = 0.5V	80	100		dB
V _{OL}	Output Voltage Swing (Low) (Note 5)	No Load		18	40	mV
		I _{SINK} = 0.5mA		45	80	mV
		I _{SINK} = 2.5mA		110	220	mV
V _{OH}	Output Voltage Swing (High) (Note 5)	No Load		3.5	15	mV
		I _{SOURCE} = 0.5mA		60	120	mV
		I _{SOURCE} = 2.5mA		170	300	mV

ELECTRICAL CHARACTERISTICS

-40°C < T_A < 85°C, V_S = 5V, 0V; V_S = 3V, 0V; V_{CM} = V_{OUT} = half supply, unless otherwise noted. (Note 3)

SYMBOL	PARAMETER	CONDITIONS	MIN	TYP	MAX	UNITS
I _{SC}	Short-Circuit Current	V _S = 5V	●	±7.5	±15	mA
		V _S = 3V	●	±7.5	±15	
I _S	Supply Current per Amplifier		●	2.0	2.7	mA
GBW	Gain-Bandwidth Product (Note 6)		●	5.8	8.5	MHz
SR	Slew Rate (Note 7)	V _S = 5V, A _V = -1, R _L = Open, V _O = 4V	●	2.2	3.6	V/μs
		V _S = 3V, A _V = -1, R _L = Open	●	1.9	3.2	

T_A = 25°C, V_S = ±15V, V_{CM} = 0V, V_{OUT} = 0V, unless otherwise noted.

SYMBOL	PARAMETER	CONDITIONS	MIN	TYP	MAX	UNITS
V _{OS}	Input Offset Voltage	V _{CM} = V ⁺		200	800	μV
		V _{CM} = V ⁻		200	800	μV
ΔV _{OS}	Input Offset Voltage Shift	V _{CM} = V ⁻ to V ⁺		150	650	μV
	Input Offset Voltage Match (Channel-to-Channel)	V _{CM} = V ⁺ , V ⁻ (Note 4)		250	1400	μV
I _B	Input Bias Current	V _{CM} = V ⁺	0	250	550	nA
		V _{CM} = V ⁻	-550	-250	0	nA
ΔI _B	Input Bias Current Shift	V _{CM} = V ⁻ to V ⁺		500	1100	nA
	Input Bias Current Match (Channel-to-Channel)	V _{CM} = V ⁺ (Note 4) V _{CM} = V ⁻ (Note 4)	0 -120	12 -12	120 0	nA nA
I _{OS}	Input Offset Current	V _{CM} = V ⁺		6	60	nA
		V _{CM} = V ⁻		6	60	nA
ΔI _{OS}	Input Offset Current Shift	V _{CM} = V ⁻ to V ⁺		12	120	nA
e _n	Input Noise Voltage	0.1Hz to 10Hz		400		nV _{p-p}
	Input Noise Voltage Density	f = 1kHz		12		nV/√Hz
i _n	Input Noise Current Density	f = 1kHz		0.3		pA/√Hz
A _{VOL}	Large-Signal Voltage Gain	V _O = -14.5V to 14.5V, R _L = 10k	1000	5200		V/mV
		V _O = -10V to 10V, R _L = 2k	500	2300		V/mV
CMRR	Common-Mode Rejection Ratio	V _{CM} = V ⁻ to V ⁺	93	106		dB
	CMRR Match (Channel-to-Channel) (Note 4)	V _{CM} = V ⁻ to V ⁺	87	103		dB
PSRR	Power Supply Rejection Ratio	V _S = ±5V to ±15V	89	110		dB
	PSRR Match (Channel-to-Channel) (Note 4)	V _S = ±5V to ±15V	83	105		dB
V _{OL}	Output Voltage Swing (Low) (Note 5)	No Load		18	30	mV
		I _{SINK} = 0.5mA		40	80	mV
		I _{SINK} = 10mA		230	500	mV
V _{OH}	Output Voltage Swing (High) (Note 5)	No Load		2.5	10	mV
		I _{SINK} = 0.5mA		55	120	mV
		I _{SINK} = 10mA		420	800	mV
I _{SC}	Short-Circuit Current		±15	±30		mA
I _S	Supply Current per Amplifier			1.8	2.5	mA
GBW	Gain-Bandwidth Product (Note 6)		6.8	10.5		MHz
SR	Slew Rate	A _V = -1, R _L = Open, V _O = ±10V Measure at V _O = ±5V	3.5	6		V/μs

ELECTRICAL CHARACTERISTICS

0°C < T_A < 70°C, V_S = ±15V, V_{CM} = 0V, V_{OUT} = 0V, unless otherwise noted.

SYMBOL	PARAMETER	CONDITIONS	MIN	TYP	MAX	UNITS	
V _{OS}	Input Offset Voltage	V _{CM} = V ⁺	●	200	900	μV	
		V _{CM} = V ⁻ + 0.1V	●	200	900	μV	
V _{OS} TC	Input Offset Voltage Drift (Note 2)	V _{CM} = V ⁺	●	1.0	3.5	μV/°C	
			●	2.0	5.0	μV/°C	
ΔV _{OS}	Input Offset Voltage Shift	V _{CM} = V ⁻ + 0.1V to V ⁺	●	200	750	μV	
	Input Offset Voltage Match (Channel-to-Channel)	V _{CM} = V ⁻ + 0.1V, V ⁺ (Note 4)	●	350	1500	μV	
I _B	Input Bias Current	V _{CM} = V ⁺	●	0	300	675	nA
		V _{CM} = V ⁻ + 0.1V	●	-675	-300	0	nA
ΔI _B	Input Bias Current Shift	V _{CM} = V ⁻ + 0.1V to V ⁺	●	600	1350	nA	
	Input Bias Current Match (Channel-to-Channel)	V _{CM} = V ⁺ (Note 4) V _{CM} = V ⁻ + 0.1V (Note 4)	● ●	0 -180	20 -20	180 0	nA nA
I _{OS}	Input Offset Current	V _{CM} = V ⁺	●	15	90	nA	
		V _{CM} = V ⁻ + 0.1V	●	15	90	nA	
ΔI _{OS}	Input Offset Current Shift	V _{CM} = V ⁻ + 0.1V to V ⁺	●	30	180	nA	
A _{VOL}	Large-Signal Voltage Gain	V _O = -14.5V to 14.5V, R _L = 10k	●	900	5000	V/mV	
		V _O = -10V to 10V, R _L = 2k	●	400	2000	V/mV	
	Channel Separation	V _O = -10V to 10V, R _L = 2k	●	112	125	dB	
CMRR	Common Mode Rejection Ratio	V _{CM} = V ⁻ + 0.1V to V ⁺	●	92	103	dB	
	CMRR Match (Channel-to-Channel) (Note 4)	V _{CM} = V ⁻ + 0.1V to V ⁺	●	86	103	dB	
PSRR	Power Supply Rejection Ratio	V _S = ±5V to ±15V	●	88	103	dB	
	PSRR Match (Channel-to-Channel) (Note 4)	V _S = ±5V to ±15V	●	82	103	dB	
V _{OL}	Output Voltage Swing (Low) (Note 5)	No Load	●	18	40	mV	
		I _{SINK} = 0.5mA	●	45	90	mV	
		I _{SINK} = 10mA	●	270	520	mV	
V _{OH}	Output Voltage Swing (High) (Note 5)	No Load	●	3.5	15	mV	
		I _{SOURCE} = 0.5mA	●	60	120	mV	
		I _{SOURCE} = 10mA	●	480	1000	mV	
I _{SC}	Short-Circuit Current		●	±12	±28	mA	
I _S	Supply Current per Amplifier		●	1.9	2.8	mA	
GBW	Gain-Bandwidth Product (Note 6)		●	6.1	9	MHz	
SR	Slew Rate	A _V = -1, R _L = Open, V _O = ±10V Measured at V _O = ±5V	●	3.4	5.3	V/μs	

ELECTRICAL CHARACTERISTICS

–40°C < T_A < 85°C, V_S = ±15V, V_{CM} = 0V, V_{OUT} = 0V, unless otherwise noted. (Note 3)

SYMBOL	PARAMETER	CONDITIONS	MIN	TYP	MAX	UNITS
V _{OS}	Input Offset Voltage	V _{CM} = V ⁺	●	300	950	μV
		V _{CM} = V ⁻ + 0.1V	●	300	950	μV
V _{OS} TC	Input Offset Voltage Drift (Note 2)	V _{CM} = V ⁺	●	1.0	3.5	μV/°C
			●	2.0	5.0	μV/°C
ΔV _{OS}	Input Offset Voltage Shift	V _{CM} = V ⁻ + 0.1V to V ⁺	●	250	850	μV
	Input Offset Voltage Match (Channel-to-Channel)	V _{CM} = V ⁻ + 0.1V, V ⁺ (Note 4)	●	350	1800	μV
I _B	Input Bias Current	V _{CM} = V ⁺	●	0	350	nA
		V _{CM} = V ⁻ + 0.1V	●	-800	-350	0
ΔI _B	Input Bias Current Shift	V _{CM} = V ⁻ + 0.1V to V ⁺	●	700	1600	nA
	Input Bias Current Match (Channel-to-Channel)	V _{CM} = V ⁺ (Note 4) V _{CM} = V ⁻ + 0.1V (Note 4)	● ●	0 -200	20 -20	200 0
I _{OS}	Input Offset Current	V _{CM} = V ⁺	●	15	100	nA
		V _{CM} = V ⁻ + 0.1V	●	15	100	nA
ΔI _{OS}	Input Offset Current Shift	V _{CM} = V ⁻ + 0.1V to V ⁺	●	30	200	nA
A _{VOL}	Large-Signal Voltage Gain	V _O = -14.5V to 14.5V, R _L = 10k	●	800	5000	V/mV
		V _O = -10V to 10V, R _L = 2k	●	350	2000	V/mV
	Channel Separation	V _O = -10V to 10V, R _L = 2k	●	110	120	dB
CMRR	Common Mode Rejection Ratio	V _{CM} = V ⁻ + 0.1V to V ⁺	●	90	101	dB
		V _{CM} = V ⁻ + 0.1V to V ⁺	●	86	100	dB
PSRR	Power Supply Rejection Ratio	V _S = ±5V to ±15V	●	88	100	dB
		V _S = ±5V to ±15V	●	82	100	dB
V _{OL}	Output Voltage Swing (Low) (Note 5)	No Load	●	25	50	mV
		I _{SINK} = 0.5mA	●	50	100	mV
		I _{SINK} = 10mA	●	275	520	mV
V _{OH}	Output Voltage Swing (High) (Note 5)	No Load	●	3.5	15	mV
		I _{SOURCE} = 0.5mA	●	65	120	mV
		I _{SOURCE} = 10mA	●	500	1000	mV
I _{SC}	Short-Circuit Current		●	±10	±18	mA
I _S	Supply Current per Amplifier		●	2.0	3.0	mA
GBW	Gain-Bandwidth Product (Note 6)		●	5.8	8.5	MHz
SR	Slew Rate	A _V = -1, R _L = Open, V _O = ±10V, Measure at V _O = ±5V	●	3	4.75	V/μs

The ● denotes specifications that apply over the full operating temperature range.

Note 1: A heat sink may be required to keep the junction temperature below the absolute maximum rating when the output is shorted indefinitely.

Note 2: This parameter is not 100% tested.

Note 3: The LT1498/LT1499 are designed, characterized and expected to meet these extended temperature limits, but are not tested at -40°C and 85°C. Guaranteed I grade parts are available, consult factory.

Note 4: Matching parameters are the difference between amplifiers A and D and between B and C on the LT1499; between the two amplifiers on the LT1498.

Note 5: Output voltage swings are measured between the output and power supply rails.

Note 6: V_S = 3V, V_S = ±15V GBW limit guaranteed by correlation to 5V tests.

Note 7: V_S = 3V, V_S = 5V slew rate limit guaranteed by correlation to ±15V tests.

TYPICAL PERFORMANCE CHARACTERISTICS

V_{OS} Distribution, $V_{CM} = 0V$ (PNP Stage)

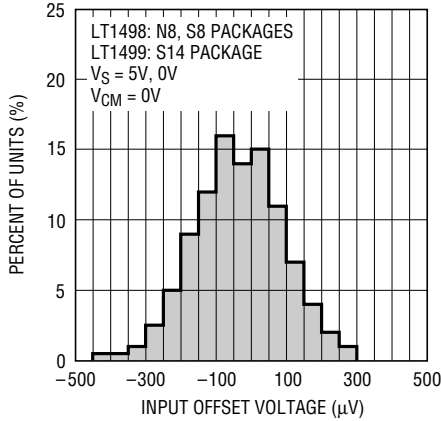

1498/99 G01

V_{OS} Distribution $V_{CM} = 5V$ (NPN Stage)

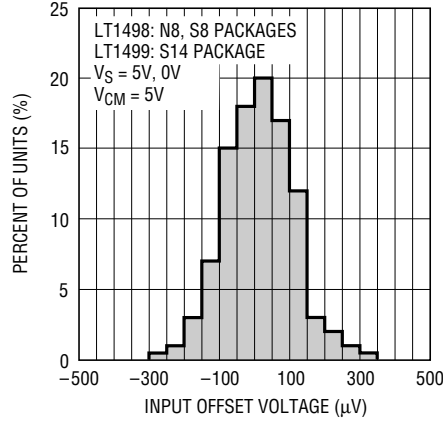

1498/99 G02

ΔV_{OS} Shift for $V_{CM} = 0V$ to $5V$

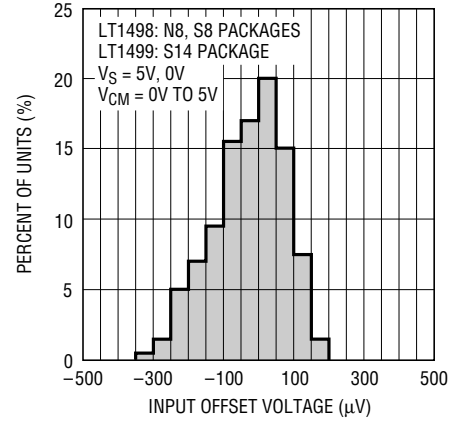

1498/99 G03

Supply Current vs Supply Voltage

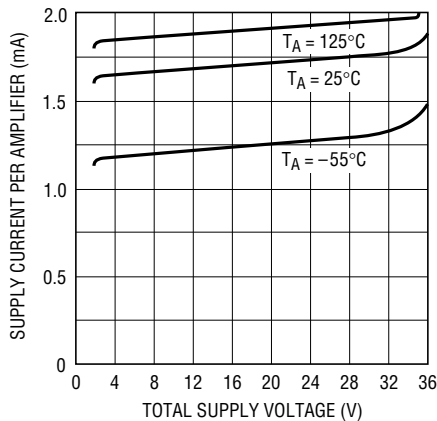

1498/99 G04

Supply Current vs Temperature

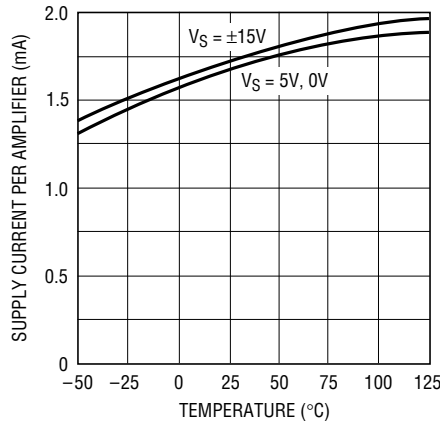

1498/99 G05

Input Bias Current vs Common Mode Voltage

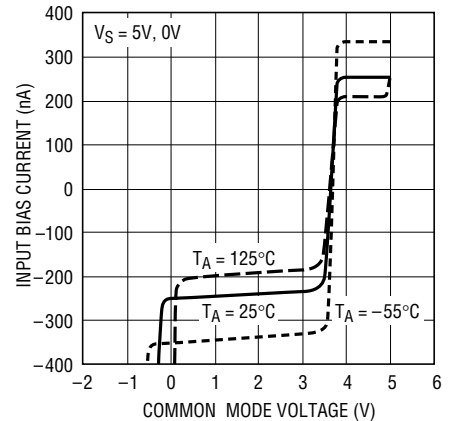

1498/99 G06

Input Bias Current vs Temperature

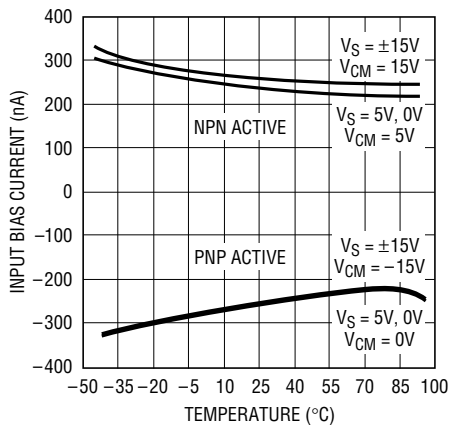

1498/99 G07

Output Saturation Voltage vs Load Current (Output High)

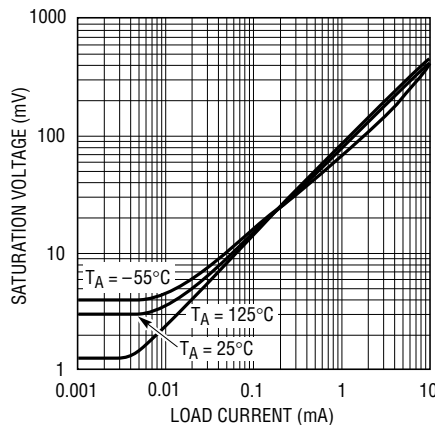

1498/99 G08

Output Saturation Voltage vs Load Current (Output Low)

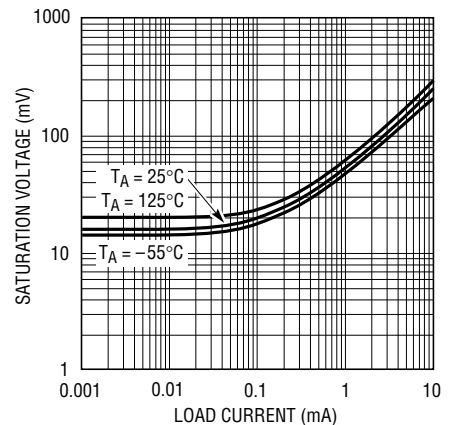

1498/99 G09

TYPICAL PERFORMANCE CHARACTERISTICS

Minimum Supply Voltage

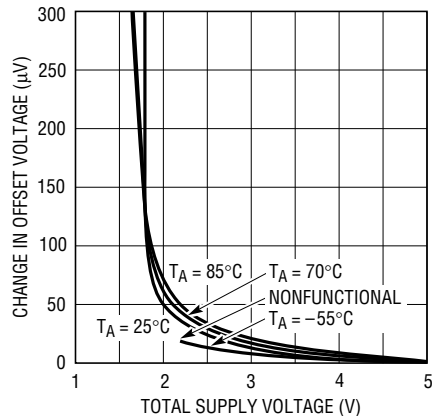

1498/99 G10

0.1Hz to 10Hz Output Voltage Noise

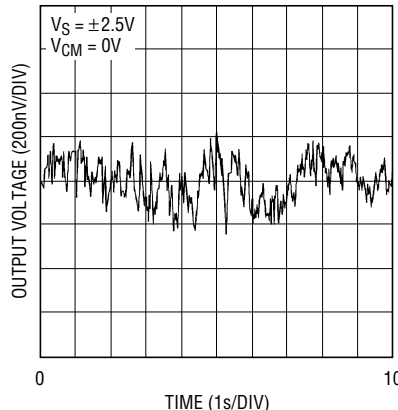

1498/99 G11

Noise Voltage Spectrum

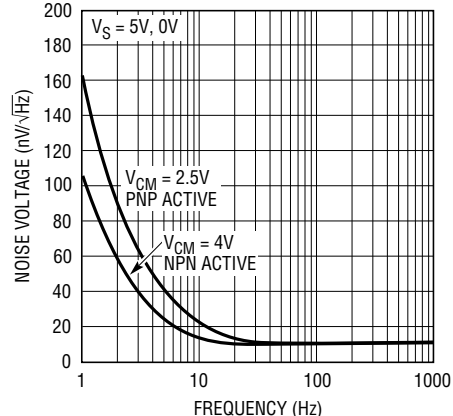

1498/99 G12

Noise Current Spectrum

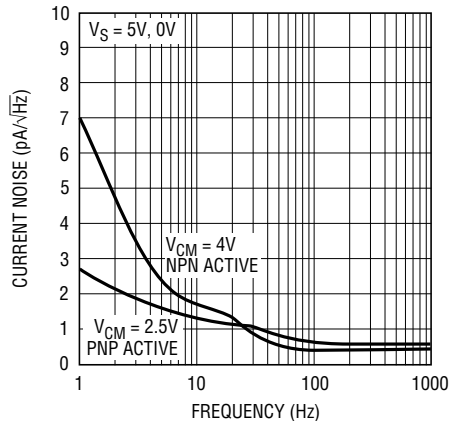

1498/99 G13

Gain and Phase vs Frequency

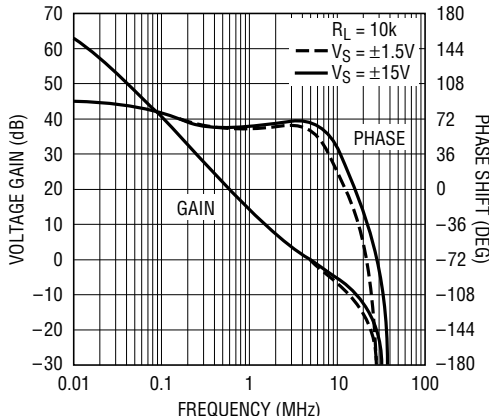

1498/99 G14

CMRR vs Frequency

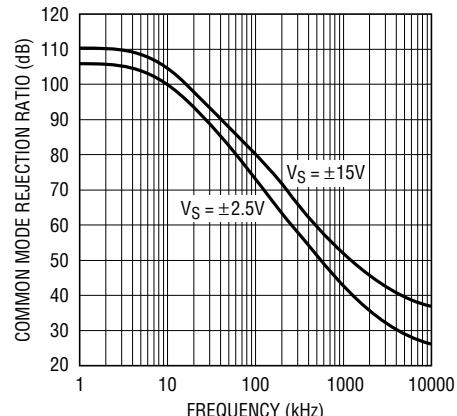

1498/99 G15

PSRR vs Frequency

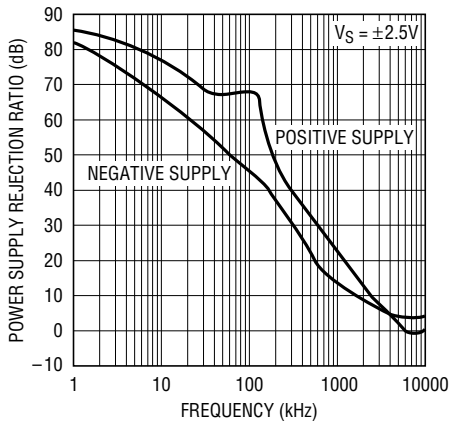

1498/99 G16

Gain Bandwidth and Phase Margin vs Supply Voltage

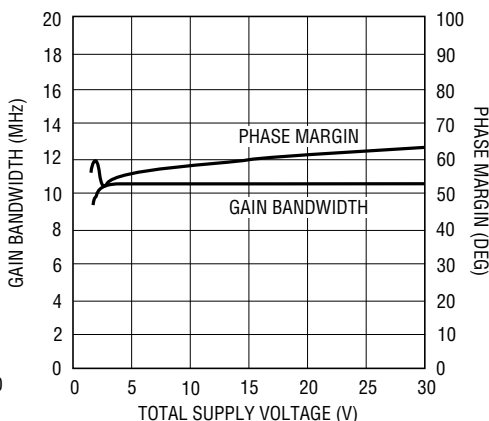

1498/99 G17

Channel Separation vs Frequency

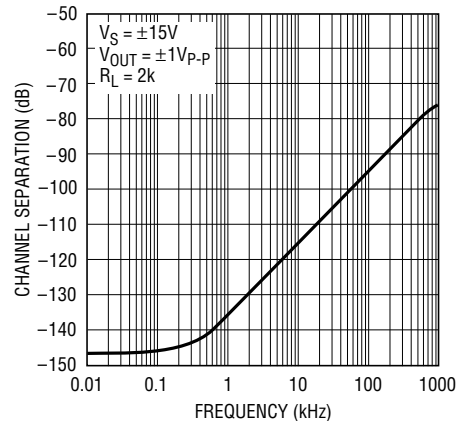

1498/99 G18

TYPICAL PERFORMANCE CHARACTERISTICS

Capacitive Load Handling

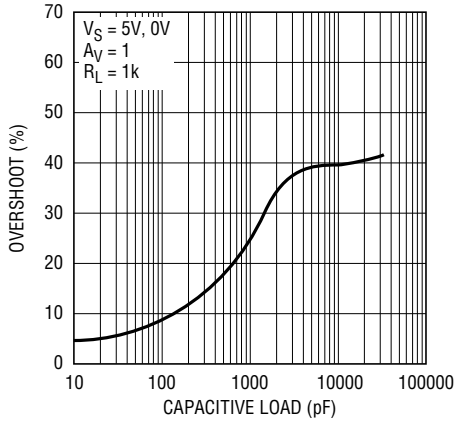

1498/99 G19

Slew Rate vs Supply Voltage

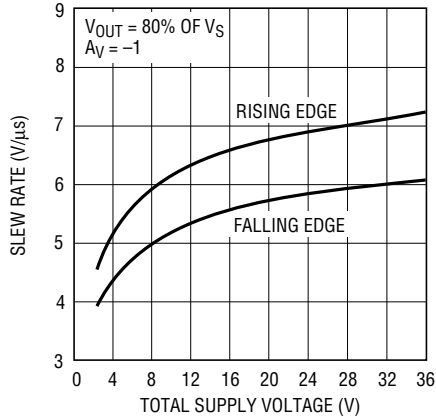

1498/99 G20

Output Step vs Settling Time to 0.01%

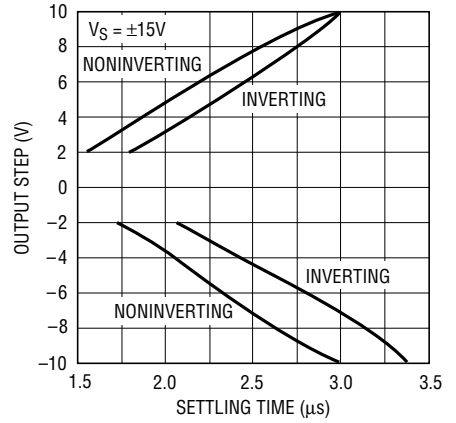

1498/99 G21

Open-Loop Gain

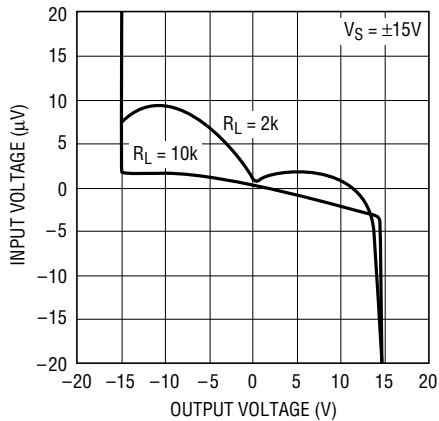

1498/99 G22

Open-Loop Gain

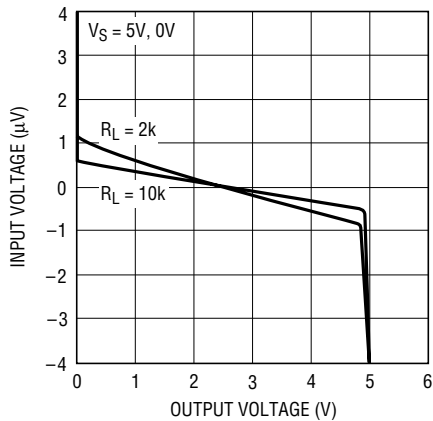

1498/99 G23

Warm-Up Drift vs Time

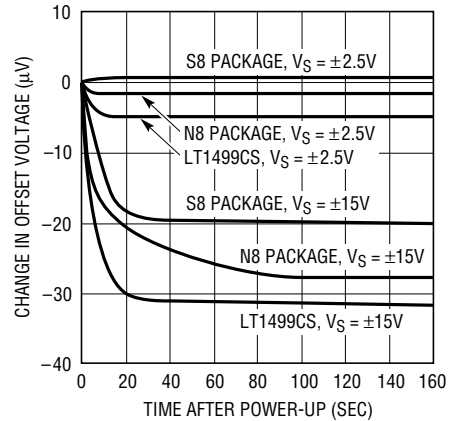

1498/99 G24

Total Harmonic Distortion + Noise vs Peak-to-Peak Voltage

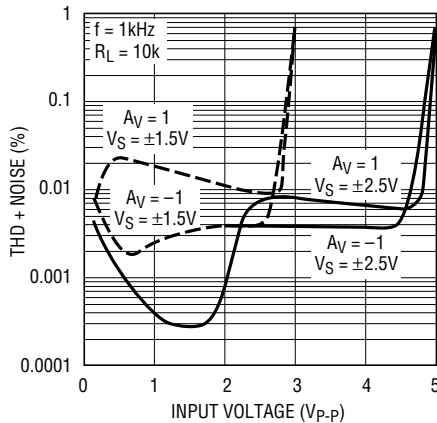

1498/99 G25

Total Harmonic Distortion + Noise vs Frequency

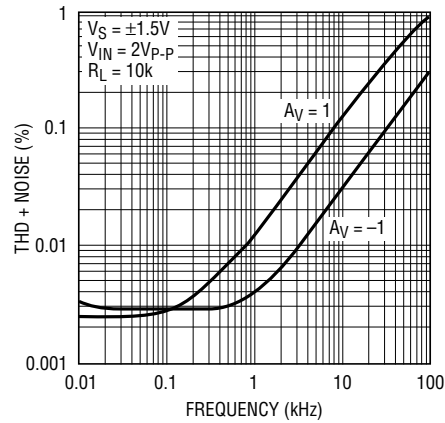

1498/99 G26

TYPICAL PERFORMANCE CHARACTERISTICS

5V Small-Signal Response

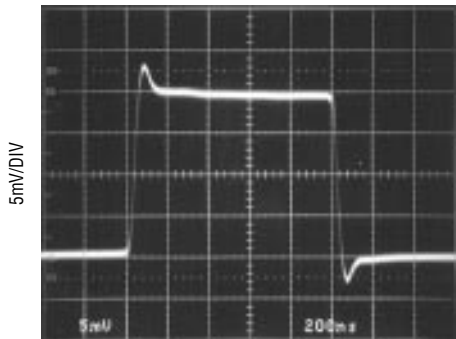

$V_S = 5V$
 $A_V = 1$
 $V_{IN} = 20mV_{p-p}$ AT 50kHz
 $R_L = 1k$

5V Large-Signal Response

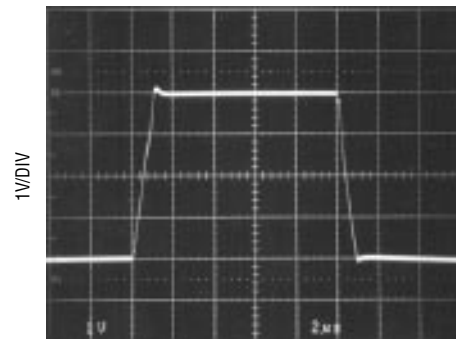

$V_S = 5V$
 $A_V = 1$
 $V_{IN} = 4V_{p-p}$ AT 10kHz
 $R_L = 1k$

±15V Small-Signal Response

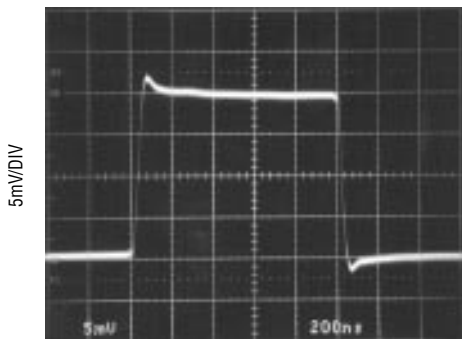

$V_S = \pm 15V$
 $A_V = 1$
 $V_{IN} = 20mV_{p-p}$ AT 50kHz
 $R_L = 1k$

±15V Large-Signal Response

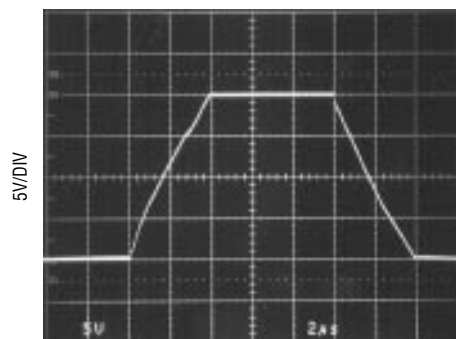

$V_S = \pm 15V$
 $A_V = 1$
 $V_{IN} = 20V_{p-p}$ AT 10kHz
 $R_L = 1k$

APPLICATIONS INFORMATION

Rail-to-Rail Input and Output

The LT1498/LT1499 are fully functional for an input and output signal range from the negative supply to the positive supply. Figure 1 shows a simplified schematic of the amplifier. The input stage consists of two differential amplifiers, a PNP stage (Q1/Q2) and an NPN stage (Q3/Q4) which are active over different ranges of input common mode voltage. A complementary common emitter output stage (Q14/Q15) is employed allowing the output to swing from rail-to-rail. The devices are fabricated on Linear Technology's proprietary complementary bipolar process to ensure very similar DC and AC characteristics for the output devices (Q14/Q15).

The PNP differential input pair is active for input common mode voltages, V_{CM} , between the negative supply to approximately 1.3V below the positive supply. As V_{CM} moves further toward the positive supply, the transistor Q5 will steer the tail current, I_1 , to the current mirror Q6/Q7 activating the NPN differential pair, and the PNP differential pair becomes inactive for the rest of the input common mode range up to the positive supply.

The output is configured with a pair of complementary common emitter stages that enables the output to swing from rail to rail. Capacitors C1 and C2 form local feedback loops that lower the output impedance at high frequencies.

APPLICATIONS INFORMATION

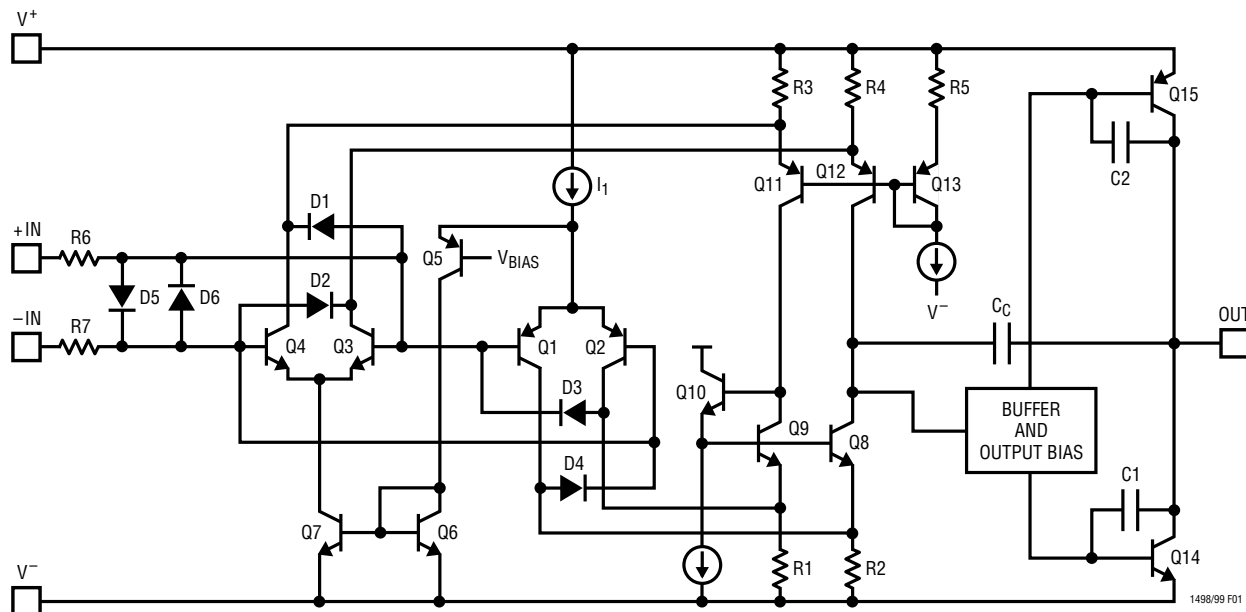

Figure 1. LT1498 Simplified Schematic Diagram

Input Offset Voltage

The offset voltage changes depending upon which input stage is active. The input offsets are random, but are trimmed to less than 475µV. To maintain the precision characteristics of the amplifier, the change of V_{OS} over the entire input common mode range (CMRR) is guaranteed to be less than 425µV on a single 5V supply.

Input Bias Current

The input bias current polarity also depends on the input common mode voltage, as described in the previous section. When the PNP differential pair is active, the input bias currents flow out of the input pins; they flow in opposite direction when the NPN input stage is active. The offset error due to input bias current can be minimized by equalizing the noninverting and inverting input source impedances. This will reduce the error since the input offset currents are much less than the input bias currents.

Overdrive Protection

To prevent the output from reversing polarity when the input voltage exceeds the power supplies, two pair of crossing diodes D1 to D4 are employed. When the input

voltage exceeds either power supply by approximately 700mV, D1/D2 or D3/D4 will turn on, forcing the output to the proper polarity. For the phase reversal protection to work properly, the input current must be less than 5mA. If the amplifier is to be severely overdriven, an external resistor should be used to limit the overdrive current.

Furthermore, the LT1498/LT1499's input stages are protected by a pair of back-to-back diodes, D5/D6. When a differential voltage of more than 0.7V is applied to the inputs, these diodes will turn on, preventing the Zener breakdown of the input transistors. The current in D5/D6 should be limited to less than 10mA. Internal resistors R6 and R7 (700Ω total) limit the input current for differential input signals of 7V or less. For larger input levels, a resistor in series with either or both inputs should be used to limit the current. Worst-case differential input voltage usually occurs when the output is shorted to ground. In addition, the amplifier is protected against ESD strikes up to 3kV on all pins.

Capacitive Load

The LT1498/LT1499 are designed for ease of use. The amplifier can drive a capacitive load of more than 10nF

APPLICATIONS INFORMATION

without oscillation at unity gain. When driving a heavy capacitive load, the bandwidth is reduced to maintain stability. Figures 2a and 2b illustrate the stability of the device for small-signal and large-signal conditions with capacitive loads. Both the small-signal and large-signal transient response with a 10nF capacitive load are well behaved.

Feedback Components

To minimize the loading effect of feedback, it is possible to use the high value feedback resistors to set the gain. However, care must be taken to insure that the pole formed by the feedback resistors and the total input capacitance at the inverting input does not degrade the stability of the amplifier. For instance, the LT1498/LT1499 in a noninverting gain of 2, set with two 30k resistors, will probably oscillate with 10pF total input capacitance (5pF input capacitance + 5pF board capacitance). The amplifier has a 2.5MHz crossing frequency and a 60° phase margin at 6dB of gain. The feedback resistors and the total input capacitance create a pole at 1.06MHz that induces 67° of phase shift at 2.5MHz! The solution is simple, either lower the value of the resistors or add a feedback capacitor of 10pF or more.

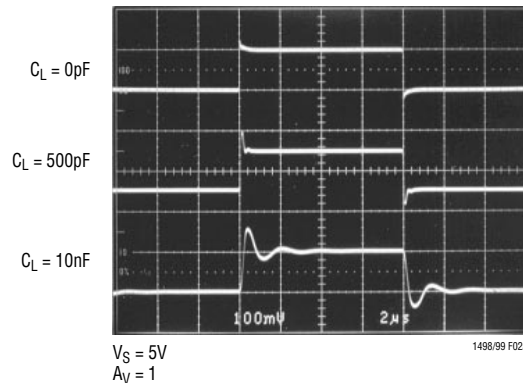

Figure 2a. LT1498 Small-Signal Response

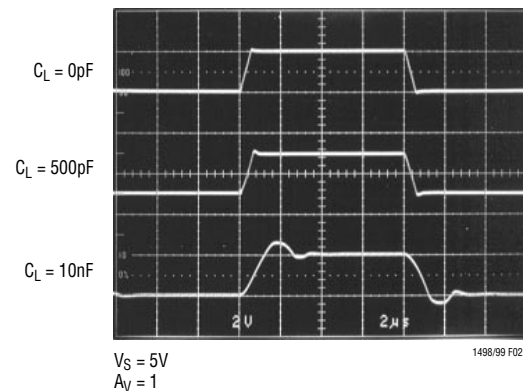
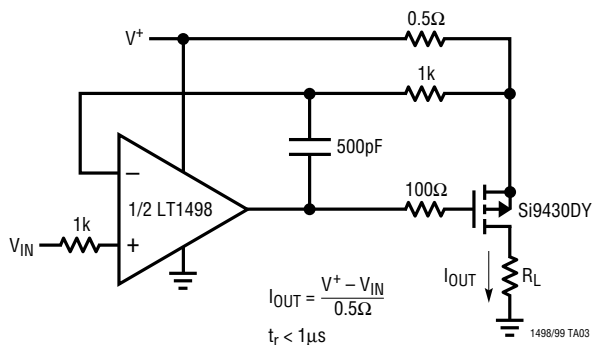

Figure 2b. LT1498 Large-Signal Response

TYPICAL APPLICATIONS

1A Voltage Controlled Current Source



1A Voltage Controlled Current Sink

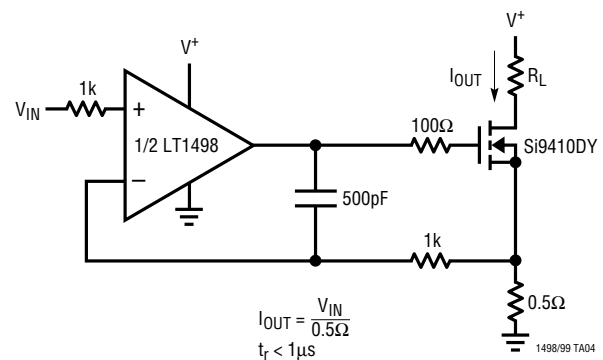

TYPICAL APPLICATIONS

Input Bias Current Cancellation

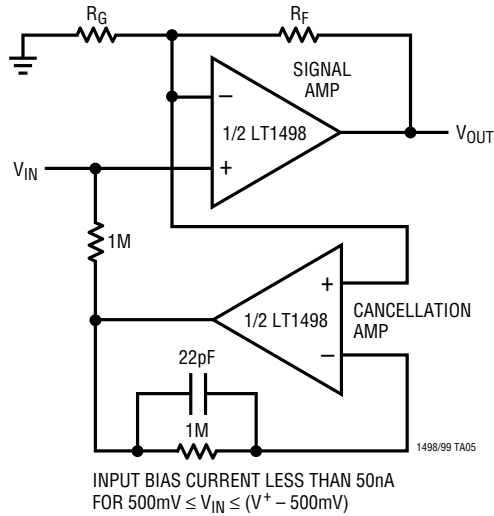

PACKAGE DESCRIPTION Dimensions in inches (millimeters) unless otherwise noted.

N8 Package
8-Lead PDIP (Narrow 0.300)
(LTC DWG # 05-08-1510)

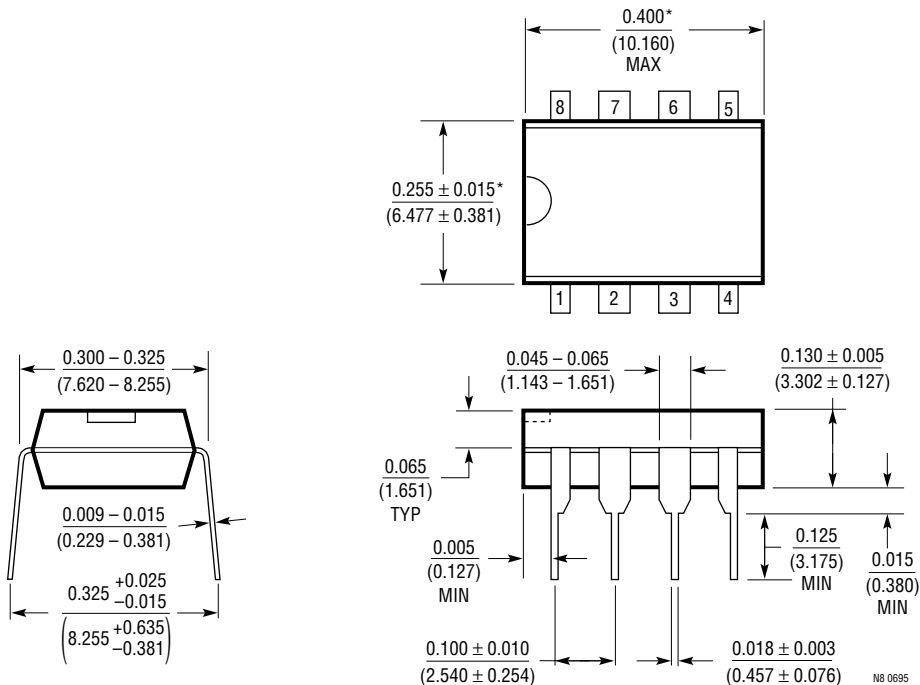

*THESE DIMENSIONS DO NOT INCLUDE MOLD FLASH OR PROTRUSIONS.
MOLD FLASH OR PROTRUSIONS SHALL NOT EXCEED 0.010 INCH (0.254mm)

PACKAGE DESCRIPTION Dimensions in inches (millimeters) unless otherwise noted.

S8 Package
8-Lead Plastic Small Outline (Narrow 0.150)
 (LTC DWG # 05-08-1610)

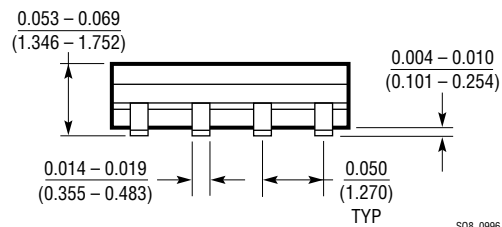
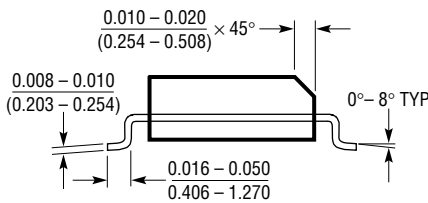
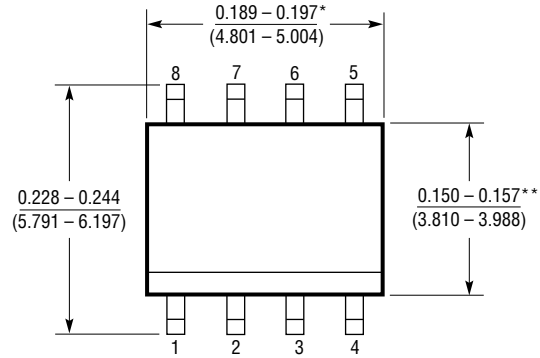

*DIMENSION DOES NOT INCLUDE MOLD FLASH. MOLD FLASH SHALL NOT EXCEED 0.006" (0.152mm) PER SIDE
 **DIMENSION DOES NOT INCLUDE INTERLEAD FLASH. INTERLEAD FLASH SHALL NOT EXCEED 0.010" (0.254mm) PER SIDE

S08 0996

S Package
14-Lead Plastic Small Outline (Narrow 0.150)
 (LTC DWG # 05-08-1610)

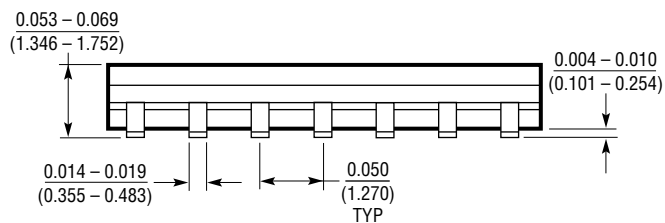
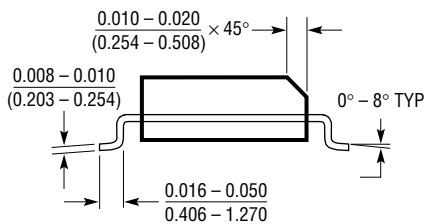
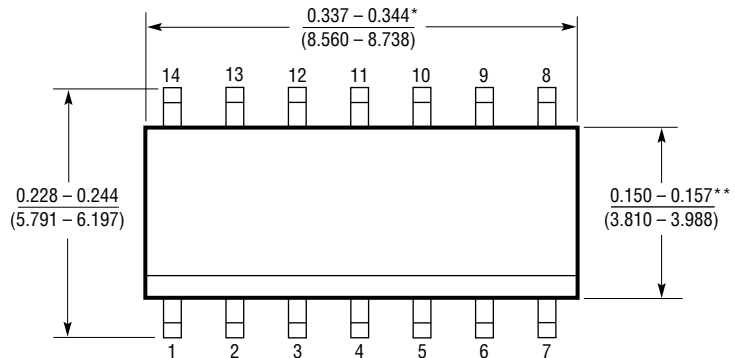

*DIMENSION DOES NOT INCLUDE MOLD FLASH. MOLD FLASH SHALL NOT EXCEED 0.006" (0.152mm) PER SIDE
 **DIMENSION DOES NOT INCLUDE INTERLEAD FLASH. INTERLEAD FLASH SHALL NOT EXCEED 0.010" (0.254mm) PER SIDE

S14 0695

TYPICAL APPLICATION

Bidirectional Current Sensor

A bidirectional current sensor for battery-powered systems is shown in Figure 3. Two outputs are provided: one proportional to charge current, the other proportional to discharge current. The circuit takes advantage of the LT1498's rail-to-rail input range and its output phase reversal protection. During the charge cycle, the op amp A1 forces a voltage equal to $(I_L)(R_{SENSE})$ across R_A . This

voltage is then amplified at the Charge Out by the ratio of R_B over R_A . In this mode, the output of A2 remains high, keeping Q2 off and the Discharge Out low, even though the (+) input of A2 exceeds the positive power supply. During the discharge cycle, A2 and Q2 are active and the operation is similar to the charge cycle.

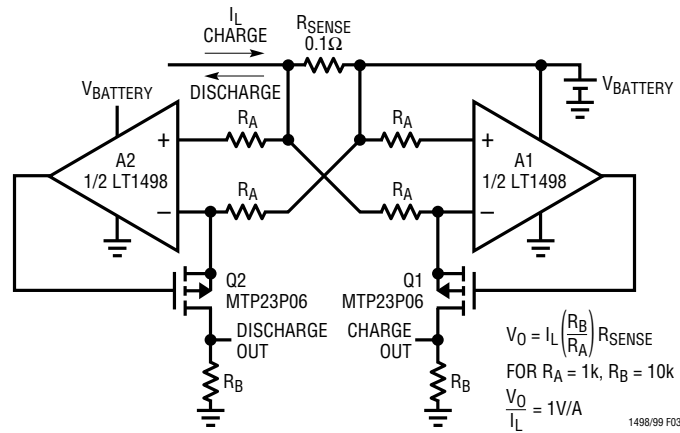

Figure 3. Bidirectional Current Sensor

RELATED PARTS

PART NUMBER	DESCRIPTON	COMMENTS
LTC [®] 1152	Rail-to-Rail Input and Output, Zero-Drift Op Amp	High DC Accuracy, 10 μ V $V_{OS(MAX)}$, 100nV/ $^{\circ}$ C Drift, 1MHz GBW, 1V/ μ s Slew Rate, Max Supply Current 2.2mA
LT1211/LT1212	Dual/Quad 14MHz, 7V/ μ s, Single Supply Precision Op Amps	Input Common Mode Includes Ground, 275 μ V $V_{OS(MAX)}$, 6 μ V/ $^{\circ}$ C Max Drift, Max Supply Current 1.8mA per Op Amp
LT1213/LT1214	Dual/Quad 28MHz, 12V/ μ s, Single Supply Precision Op Amps	Input Common Mode Includes Ground, 275 μ V $V_{OS(MAX)}$, 6 μ V/ $^{\circ}$ C Max Drift, Max Supply Current 3.5mA per Op Amp
LT1215/LT1216	Dual/Quad 23MHz, 50V/ μ s, Single Supply Precision Op Amps	Input Common Mode Includes Ground, 450 μ V $V_{OS(MAX)}$, Max Supply Current 6.6mA per Op Amp
LT1366/LT1367	Dual/Quad Precision, Rail-to-Rail Input and Output Op Amps	475 μ V $V_{OS(MAX)}$, 400kHz GBW, 0.13V/ μ s Slew Rate, Max Supply Current 520 μ A per Op Amp
LT1490/LT1491	Dual/Quad Micropower, Rail-to-Rail Input and Output Op Amps	Max Supply Current 50 μ A per Op Amp, 200kHz GBW, 0.07V/ μ s Slew Rate, Operates with Inputs 44V Above V^- Independent of V^+