

## Features

- Industry-standard Architecture
  - Emulates Many 20-pin PALs®
  - Low-cost Easy-to-use Software Tools
- High-speed Electrically-erasable Programmable Logic Devices
  - 5 ns Maximum Pin-to-pin Delay
- Low-power - 100  $\mu$ A Pin-controlled Power-down Mode Option
- CMOS and TTL Compatible Inputs and Outputs
  - I/O Pin Keeper Circuits
- Advanced Flash Technology
  - Reprogrammable
  - 100% Tested
- High-reliability CMOS Process
  - 20 Year Data Retention
  - 100 Erase/Write Cycles
  - 2,000V ESD Protection
  - 200 mA Latchup Immunity
- Commercial and Industrial Temperature Ranges
- Dual-in-line and Surface Mount Packages in Standard Pinouts
- PCI Compliant



High-performance  
EE PLD

ATF16V8C

## Block Diagram

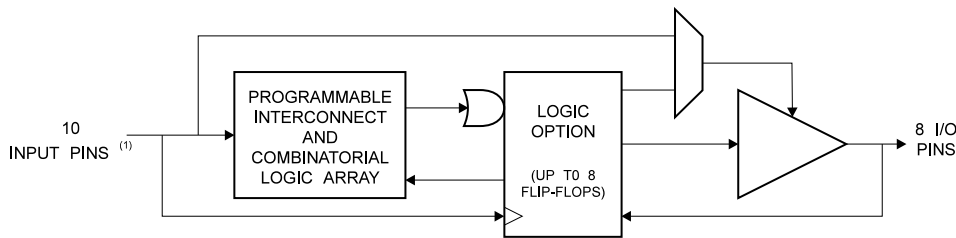

Note: 1. Includes optional PD control pin.

## Pin Configurations

All Pinouts Top View

Pin Name	Function
CLK	Clock
I	Logic Inputs
I/O	Bidirectional Buffers
$\overline{OE}$	Output Enable
VCC	+5V Supply
PD	Power-down

TSSOP

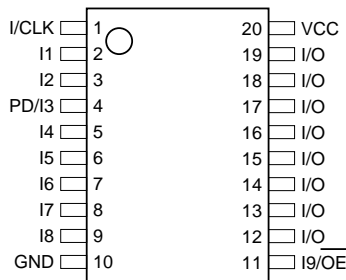

DIP/SOIC

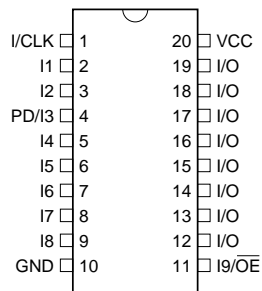

PLCC

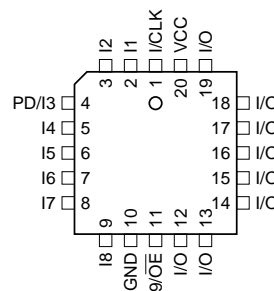

Rev. 0425G-08/99





## Description

The ATF16V8C is a high-performance EECMOS Programmable Logic Device that utilizes Atmel's proven electrically-erasable Flash memory technology. Speeds down to 5 ns and a 100  $\mu$ A pin-controlled power-down mode option are offered. All speed ranges are specified over the full 5V  $\pm$  10% range for industrial temperature ranges; 5V  $\pm$  5% for commercial range 5-volt devices.

The ATF16V8C incorporates a superset of the generic architectures, which allows direct replacement of the 16R8 family and most 20-pin combinatorial PLDs. Eight outputs are each allocated eight product terms. Three different

modes of operation, configured automatically with software, allow highly complex logic functions to be realized.

The ATF16V8C can significantly reduce total system power, thereby enhancing system reliability and reducing power supply costs. When pin 4 is configured as the power-down control pin, supply current drops to less than 100  $\mu$ A whenever the pin is high. If the power-down feature isn't required for a particular application, pin 4 may be used as a logic input. Also, the pin keeper circuits eliminate the need for internal pull-up resistors along with their attendant power consumption.

## Absolute Maximum Ratings\*

Temperature Under Bias.....	-40°C to +85°C
Storage Temperature.....	-65°C to +150°C
Voltage on Any Pin with Respect to Ground....	-2.0V to +7.0V <sup>(1)</sup>
Voltage on Input Pins with Respect to Ground During Programming.....	-2.0V to +14.0V <sup>(1)</sup>
Programming Voltage with Respect to Ground .....	-2.0V to +14.0V <sup>(1)</sup>

\*NOTICE: Stresses beyond those listed under "Absolute Maximum Ratings" may cause permanent damage to the device. This is a stress rating only and functional operation of the device at these or any other conditions beyond those indicated in the operational sections of this specification is not implied. Exposure to absolute maximum rating conditions for extended periods may affect device reliability.

Note: 1. Minimum voltage is -0.6V DC, which may undershoot to -2.0V for pulses of less than 20 ns. Maximum output pin voltage is  $V_{CC} + 0.75V$  DC, which may overshoot to 7.0V for pulses of less than 20 ns.

## DC and AC Operating Conditions

	Commercial	Industrial
Operating Temperature (Ambient)	0°C - 70°C	-40°C - 85°C
$V_{CC}$ Power Supply	5V $\pm$ 5%	5V $\pm$ 10%

## DC Characteristics

Symbol	Parameter	Condition	Min	Typ	Max	Units
$I_{IL}$	Input or I/O Low Leakage Current	$0 \leq V_{IN} \leq V_{IL} \text{ (Max)}$			-10.0	$\mu\text{A}$
$I_{IH}$	Input or I/O High Leakage Current	$3.5 \leq V_{IN} \leq V_{CC}$			10.0	$\mu\text{A}$
$I_{CC1}^{(1)}$	Power Supply Current, Standby	15 MHz, $V_{CC} = \text{Max}$ , $V_{IN} = 0, V_{CC}$ , Outputs Open	Com.		115	mA
			Ind.		130	mA
$I_{PD}$	Power Supply Current, Power-down Mode	$V_{CC} = \text{Max}, V_{IN} = 0, V_{CC}$	Com.	10	100	$\mu\text{A}$
			Ind.	10	105	$\mu\text{A}$
$I_{OS}$	Output Short Circuit Current	$V_{OUT} = 0.5\text{V};$ $V_{CC} = 5\text{V}; T_A = 25^\circ\text{C}$			-150	mA
$V_{IL}$	Input Low Voltage	$\text{Min} < V_{CC} < \text{Max}$	-0.5		0.8	V
$V_{IH}$	Input High Voltage		2.0		$V_{CC} + 1$	V
$V_{OL}$	Output Low Voltage	$V_{CC} = \text{Min}; \text{All Outputs}$ $I_{OL} = 24 \text{ mA}$			0.5	V
$V_{OH}$	Output High Voltage	$V_{CC} = \text{Min}$ $I_{OL} = -4.0 \text{ mA}$	2.4			V
$I_{OL}$	Output Low Current	$V_{CC} = \text{Min}$	Com.	24.0		mA
			Ind.	12.0		mA
$I_{OH}$	Output High Current	$V_{CC} = \text{Min}$	-4.0			mA

Note: 1. All  $I_{CC}$  parameters measured with outputs open.

## AC Waveforms

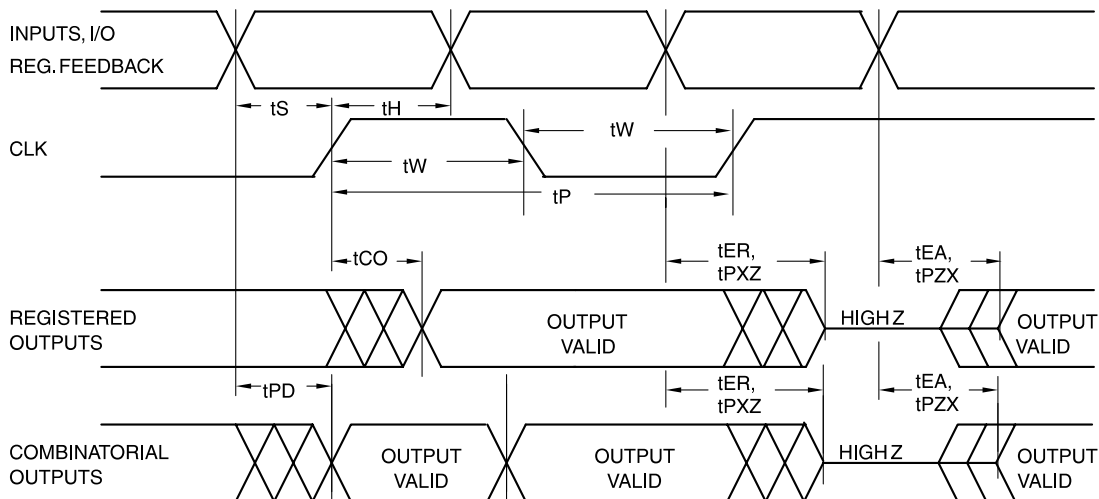

Note: 1. Timing measurement reference is 1.5V. Input AC driving levels are 0.0V and 3.0V, unless otherwise specified.

## AC Characteristics

Symbol	Parameter	-5		-7		Units
		Min	Max	Min	Max	
$t_{PD}$	Input or Feedback to Non-Registered Output	1	5	3	7.5	ns
$t_{CF}$	Clock to Feedback		3		3	ns
$t_{CO}$	Clock to Output	1	4	2	5	ns
$t_S$	Input or Feedback Setup Time	3		5		ns
$t_H$	Input Hold Time	0		0		ns
$t_P$	Clock Period	6		8		ns
$t_W$	Clock Width	3		4		ns
$F_{MAX}$	External Feedback $1/(t_S + t_{CO})$		142		100	MHz
	Internal Feedback $1/(t_S + t_{CF})$		166		125	MHz
	No Feedback $1/(t_P)$		166		125	MHz
$t_{EA}$	Input to Output Enable – Product Term	2	6	3	9	ns
$t_{ER}$	Input to Output Disable – Product Term	2	5	2	9	ns
$t_{PZX}$	$\overline{OE}$ pin to Output Enable	2	5	2	6	ns
$t_{PXZ}$	$\overline{OE}$ pin to Output Disable	1.5	5	1.5	6	ns

## Power-down AC Characteristics<sup>(1)(2)(3)</sup>

Symbol	Parameter	-5		-7		Units
		Min	Max	Min	Max	
$t_{IVDH}$	Valid Input Before PD High	5.0		7.5		ns
$t_{GV DH}$	Valid $\overline{OE}$ Before PD High	0		0		ns
$t_{CV DH}$	Valid Clock Before PD High	0		0		ns
$t_{DHIX}$	Input Don't Care After PD High		5.0		7.5	ns
$t_{DHGX}$	$\overline{OE}$ Don't Care After PD High		5.0		7.5	ns
$t_{DHCX}$	Clock Don't Care After PD High		5.0		7.5	ns
$t_{DLIV}$	PD Low to Valid Input		5.0		7.5	ns
$t_{DLGV}$	PD Low to Valid $\overline{OE}$		15.0		20.0	ns
$t_{DLCV}$	PD Low to Valid Clock		15.0		20.0	ns
$t_{DLOV}$	PD Low to Valid Output		20.0		25.0	ns

- Notes:
1. Output data is latched and held.
  2. HI-Z outputs remain HI-Z.
  3. Clock and input transitions are ignored.

## Input Test Waveforms and Measurement Levels:

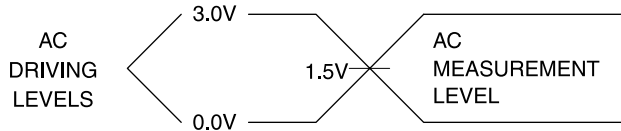

$t_R, t_F < 1.5 \text{ ns}$  (10% to 90%)

## Output Test Loads:

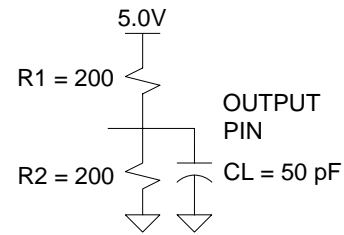

## Pin Capacitance<sup>(1)</sup>

$f = 1 \text{ MHz}, T = 25^\circ\text{C}$

	Typ	Max	Units	Conditions
$C_{IN}$	5	8	pF	$V_{IN} = 0V$
$C_{OUT}$	6	8	pF	$V_{OUT} = 0V$

Note: 1. Typical values for nominal supply voltage. This parameter is only sampled and is not 100% tested.

## Power-up Reset

The ATF16V8C's registers are designed to reset during power-up. At a point delayed slightly from  $V_{CC}$  crossing  $V_{RST}$ , all registers will be reset to the low state. As a result, the registered output state will always be high on power-up.

This feature is critical for state machine initialization. However, due to the asynchronous nature of reset and the uncertainty of how  $V_{CC}$  actually rises in the system, the following conditions are required:

1. The  $V_{CC}$  rise must be monotonic, from below 0.7V,
2. After reset occurs, all input and feedback setup times must be met before driving the clock term high, and
3. The signals from which the clock is derived must remain stable during  $t_{PR}$ .

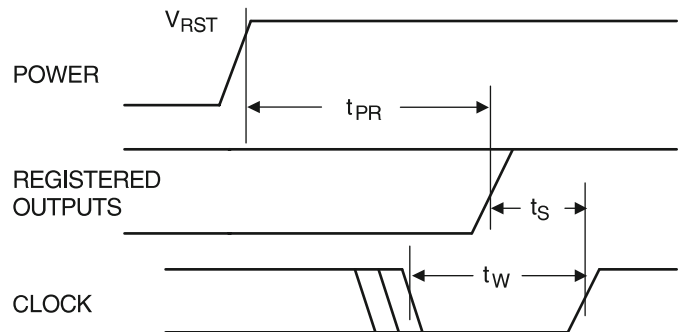

Parameter	Description	Typ	Max	Units
$t_{PR}$	Power-up Reset Time	600	1,000	ns
$V_{RST}$	Power-up Reset Voltage	3.8	4.5	V

## Power-down Mode

The ATF16V8C includes an optional pin controlled power-down feature. Device pin 4 may be configured as the power-down pin. When this feature is enabled and the power-down pin is high, total current consumption drops to less than 100  $\mu$ A. In the power-down mode, all output data and internal logic states are latched and held. All registered and combinatorial output data remains valid. Any outputs which were in a HI-Z state at the onset of power-down will remain at HI-Z. During power-down, all input signals except the power-down pin are blocked. The input and I/O pin keeper circuits remain active to insure that pins do not float to indeterminate levels. This helps to further reduce system power.

Selection of the power-down option is specified in the ATF16V8C logic design file. The logic compiler will include this option selection in the otherwise standard 16V8 JEDEC fuse file. When the power-down feature is not specified in the design file, pin 4 is available as a logic input, and there is no power-down pin. This allows the ATF16V8C to be programmed using any existing standard 16V8 fuse file.

Note: Some programmers list the JEDEC-compatible 16V8C (No PD used) separately from the non-JEDEC compatible 16V8CEXT. (EXT for extended features.)

## Registered Output Preload

The ATF16V8C's registers are provided with circuitry to allow loading of each register with either a high or a low. This feature will simplify testing since any state can be forced into the registers to control test sequencing. A JEDEC file with preload is generated when a source file with vectors is compiled. Once downloaded, the JEDEC file preload sequence will be done automatically by approved programmers.

## Security Fuse Usage

A single fuse is provided to prevent unauthorized copying of the ATF16V8C fuse patterns. Once programmed, fuse verify and preload are inhibited. However, the 64-bit User Signature remains accessible.

The security fuse will be programmed last, as its effect is immediate.

## Input and I/O Pin Keeper Circuits

The ATF16V8C contains internal input and I/O pin keeper circuits. These circuits allow each ATF16V8C pin to hold its previous value even when it is not being driven by an

external source or by the device's output buffer. This helps insure that all logic array inputs are at known, valid logic levels. This reduces system power by preventing pins from floating to indeterminate levels. By using pin keeper circuits rather than pull-up resistors, there is no DC current required to hold the pins in either logic state (high or low).

These pin keeper circuits are implemented as weak feedback inverters, as shown in the Input Diagram below. These keeper circuits can easily be overdriven by standard TTL- or CMOS-compatible drivers. The typical overdrive current required is 40  $\mu$ A.

## Input Diagram

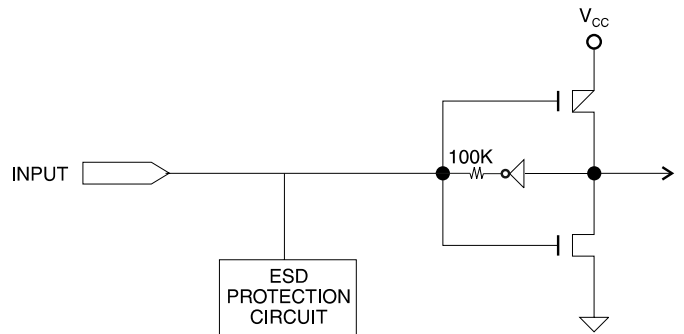

## I/O Diagram

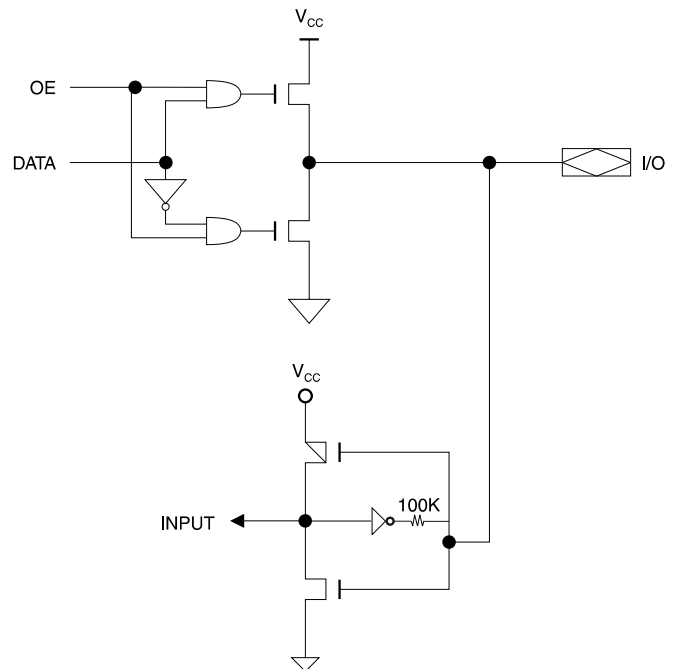

## Functional Logic Diagram Description

The Logic Option and Functional Diagrams describe the ATF16V8C architecture. Eight configurable macrocells can be configured as a registered output, combinatorial I/O, combinatorial output, or dedicated input.

The ATF16V8C can be configured in one of three different modes. Each mode makes the ATF16V8C look like a different device. Most PLD compilers can choose the right mode automatically. The user can also force the selection by supplying the compiler with a mode selection. The determining factors would be the usage of register versus combinatorial outputs and dedicated outputs versus outputs with output enable control.

The ATF16V8C universal architecture can be programmed to emulate many 20-pin PAL devices. These architectural

subsets can be found in each of the configuration modes described in the following pages. The user can download the listed subset device JEDEC programming file to the PLD programmer, and the ATF16V8C can be configured to act like the chosen device. Check with your programmer manufacturer for this capability.

Unused product terms are automatically disabled by the compiler to decrease power consumption. A Security Fuse, when programmed, protects the content of the ATF16V8C. Eight bytes (64 fuses) of User Signature are accessible to the user for purposes such as storing project name, part number, revision, or date. The User Signature is accessible regardless of the state of the Security Fuse.

## Compiler Mode Selection

	Registered	Complex	Simple	Auto Select
ABEL, Atmel-ABEL	P16V8R	P16V8C	P16V8AS	P16V8
With PD ENABLE	P16V8PDR <sup>(1)</sup>	P16V8PDC <sup>(1)</sup>	P16V8PD <sup>(1)</sup>	P16V8PDS <sup>(1)</sup>
CUPL, Atmel-CUPL	G16V8MS	G16V8MA	G16V8AS	G16V8A
With PD ENABLE	G16V8CPMS	G16V8CPMA	G16V8CPAS	G16V8CP
LOG/iC	GAL16V8_R <sup>(2)</sup>	GAL16V8_C7 <sup>(2)</sup>	GAL16V8_C8 <sup>(2)</sup>	GAL16V8
OrCAD-PLD	"Registered"	"Complex"	"Simple"	GAL16V8A
PLDesigner	P16V8R	P16V8C	P16V8C	P16V8A
Synario/Atmel-Synario	NA	NA	NA	ATF16V8C ALL
With PD ENABLE	NA	NA	NA	ATF16V8C (PD) ALL <sup>(1)</sup>
Tango-PLD	G16V8R	G16V8C	G16V8AS	G16V8

Notes: 1. Please call Atmel PLD Hotline at (408) 436-4333 for more information.  
2. Only applicable for version 3.4 or lower.

## Macrocell Configuration

Software compilers support the three different OMC modes as different device types. These device types are listed in the table below. Most compilers have the ability to automatically select the device type, generally based on the register usage and output enable ( $\overline{OE}$ ) usage. Register usage on the device forces the software to choose the registered mode. All combinatorial outputs with  $\overline{OE}$  controlled by the product term will force the software to choose the complex mode. The software will choose the simple mode only when all outputs are dedicated combinatorial without  $\overline{OE}$  control. The different device types listed in the table can be used to override the automatic device selection by the software. For further details, refer to the compiler software manuals.

When using compiler software to configure the device, the user must pay special attention to the following restrictions in each mode.

In **registered mode** pin 1 and pin 11 are permanently configured as clock and output enable, respectively. These pins cannot be configured as dedicated inputs in the registered mode.

In **complex mode** pin 1 and pin 11 become dedicated inputs and use the feedback paths of pin 19 and pin 12 respectively. Because of this feedback path usage, pin 19 and pin 12 do not have the feedback option in this mode.

In **simple mode** all feedback paths of the output pins are routed via the adjacent pins. In doing so, the two inner most pins (pins 15 and 16) will not have the feedback option as these pins are always configured as dedicated combinatorial output.

## ATF16V8C Registered Mode

### PAL Device Emulation/PAL Replacement

The registered mode is used if one or more registers are required. Each macrocell can be configured as either a registered or combinatorial output or I/O, or as an input. For a registered output or I/O, the output is enabled by the  $\overline{OE}$  pin, and the register is clocked by the CLK pin. Eight product terms are allocated to the sum term. For a combinatorial output or I/O, the output enable is controlled by a product term, and seven product terms are allocated to the sum term. When the macrocell is configured as an input, the output enable is permanently disabled.

Any register usage will make the compiler select this mode. The following registered devices can be emulated using this mode:

16R8	16RP8
16R6	16RP6
16R4	16RP4

## Registered Configuration for Registered Mode<sup>(1)(2)</sup>

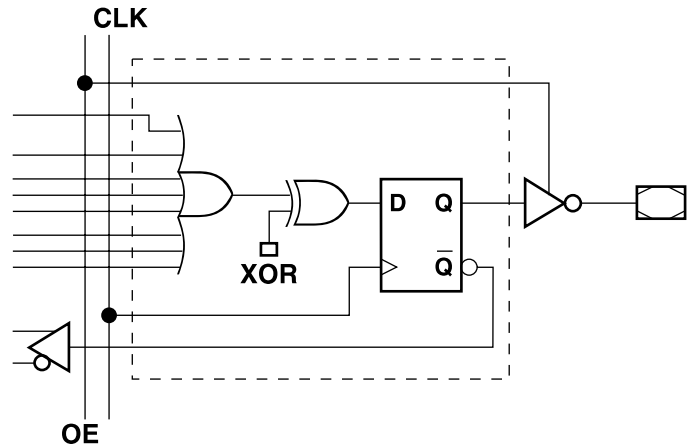

- Notes:
1. Pin 1 controls common CLK for the registered outputs.  
Pin 11 controls common  $\overline{OE}$  for the registered outputs.  
Pin 1 and Pin 11 are permanently configured as CLK and  $\overline{OE}$ .
  2. The development software configures all the architecture control bits and checks for proper pin usage automatically.

## Combinatorial Configuration for Registered Mode<sup>(1)(2)</sup>

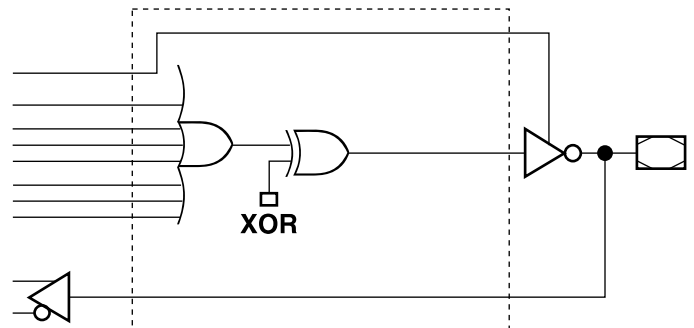

- Notes:
1. Pin 1 and Pin 11 are permanently configured as CLK and  $\overline{OE}$ .
  2. The development software configures all the architecture control bits and checks for proper pin usage automatically.



Registered Mode Logic Diagram

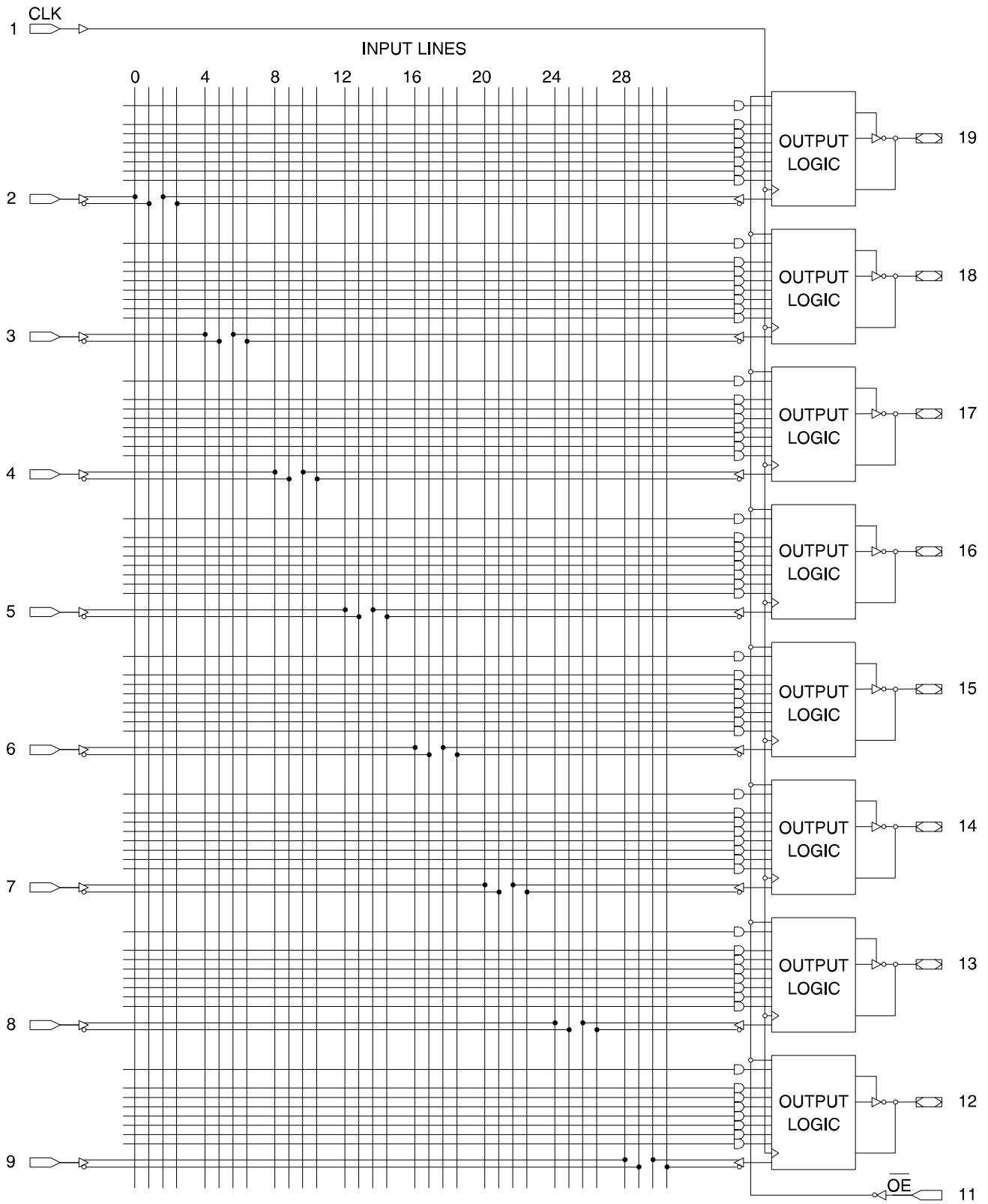

\* Input not available if power-down mode is enabled.

## ATF16V8C Complex Mode

### PAL Device Emulation/PAL Replacement

In the Complex Mode, combinatorial output and I/O functions are possible. Pins 1 and 11 are regular inputs to the array. Pins 13 through 18 have pin feedback paths back to the AND-array, which makes full I/O capability possible. Pins 12 and 19 (outermost macrocells) are outputs only. They do not have input capability. In this mode, each macrocell has seven product terms going to the sum term and one product term enabling the output.

Combinatorial applications with an  $\overline{OE}$  requirement will make the compiler select this mode. The following devices can be emulated using this mode:

16L8  
16H8  
16P8

### Complex Mode Option

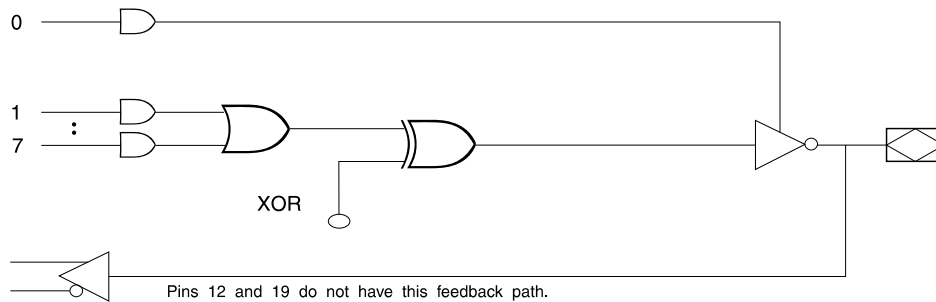

## ATF16V8C Simple Mode

### PAL Device Emulation/PAL Replacement

In the Simple Mode, 8 product terms are allocated to the sum term. Pins 15 and 16 (center macrocells) are permanently configured as combinatorial outputs. Other macrocells can be either inputs or combinatorial outputs with pin feedback to the AND-array. Pins 1 and 11 are regular inputs.

The compiler selects this mode when all outputs are combinatorial without  $\overline{OE}$  control. The following simple PALs can be emulated using this mode:

10L8 10H8 10P8  
12L6 12H6 12P6  
14L4 14H4 14P4  
16L2 16H2 16P2

### Simple Mode Option

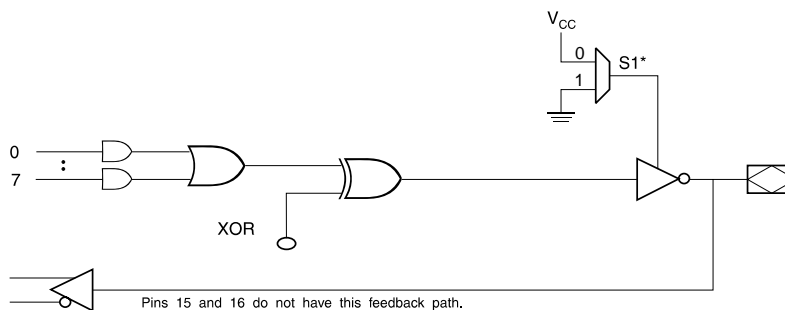

\* - Pins 15 and 16 are always enabled.

Complex Mode Logic Diagram

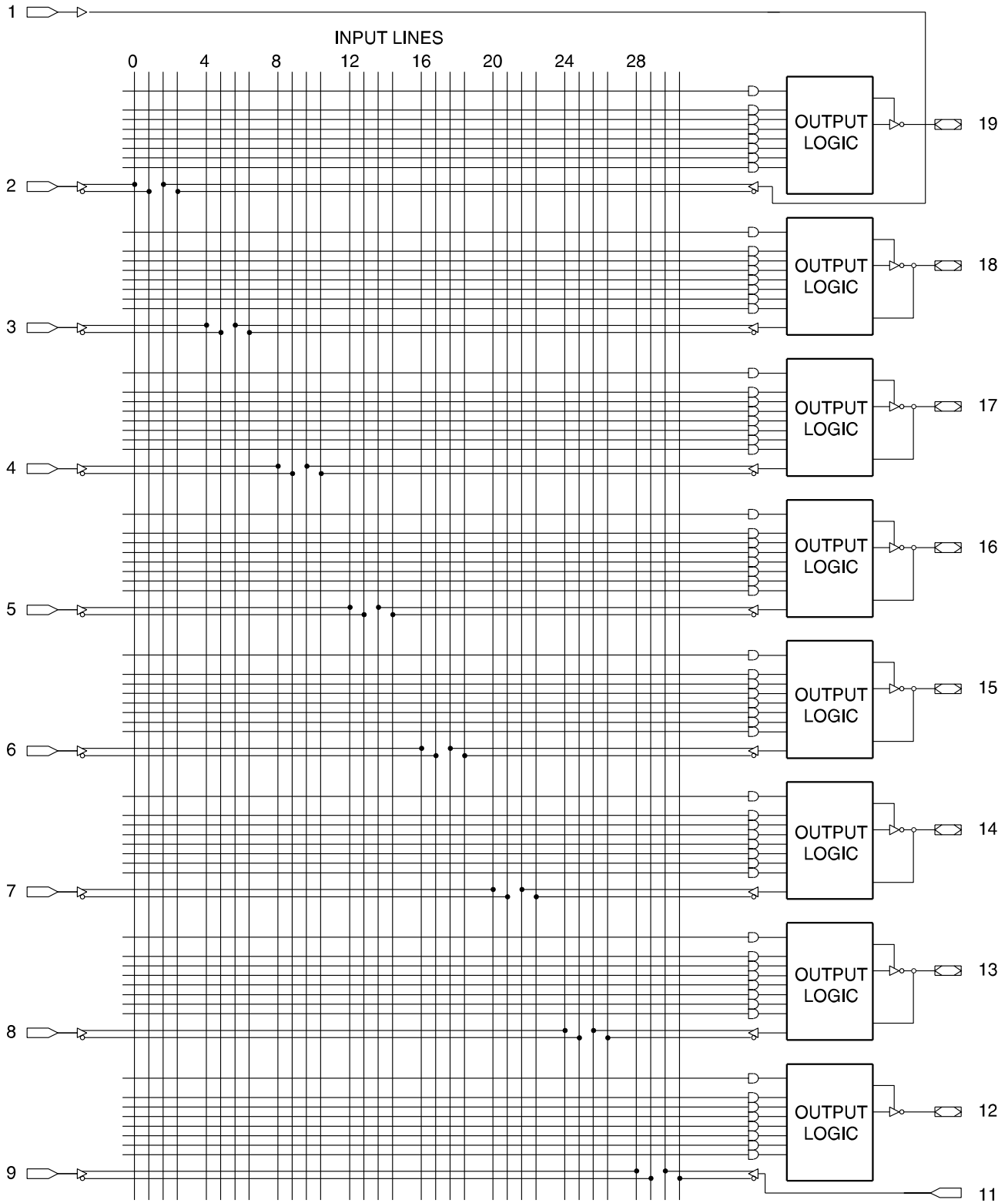

\* Input not available if power-down mode is enabled.

# Simple Mode Logic Diagram

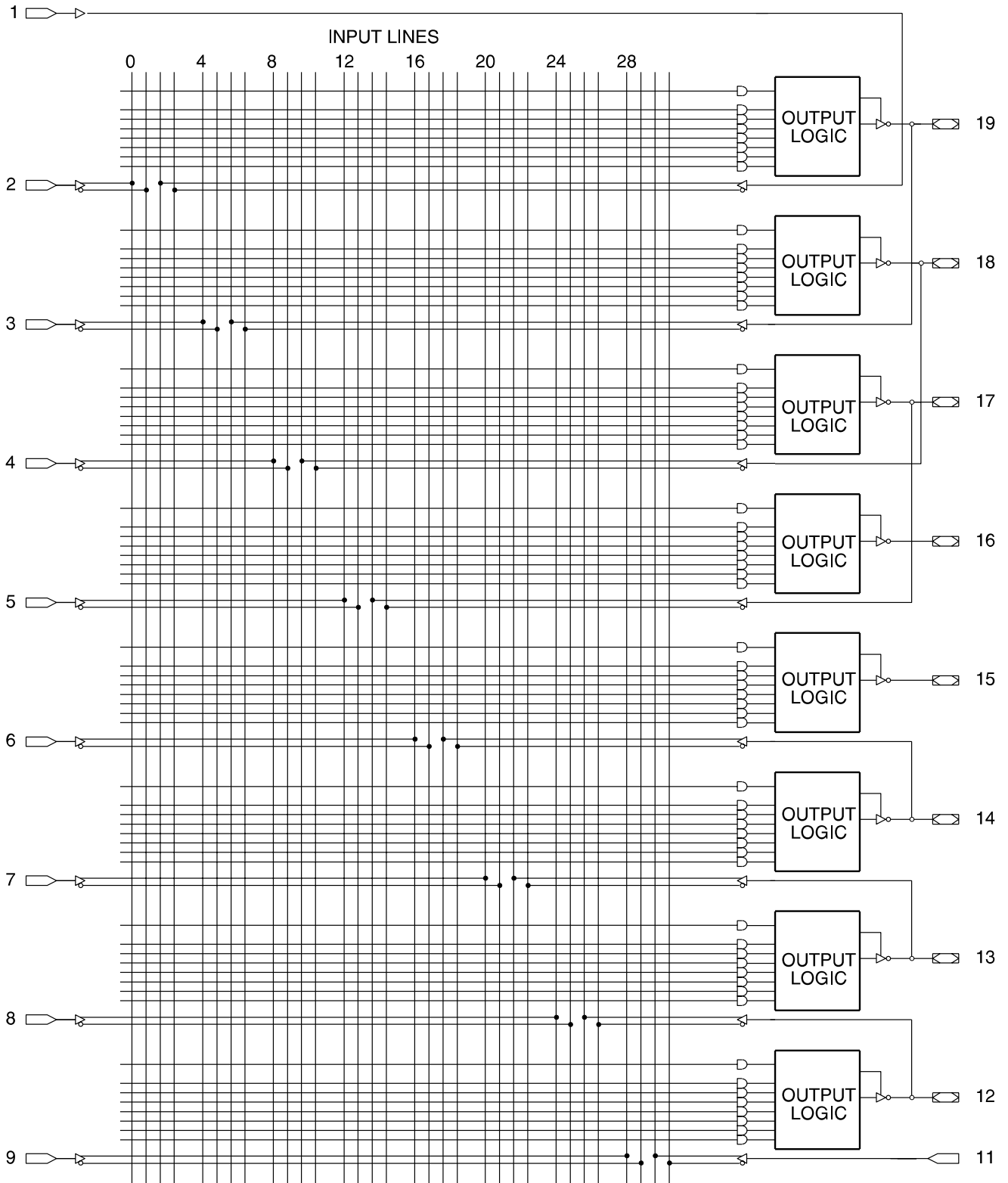

\* Input not available if power-down mode is enabled.

**SUPPLY CURRENT**  
VS. INPUT FREQUENCY  
ATF16V8C (VCC = 5V, TA = 25°C)

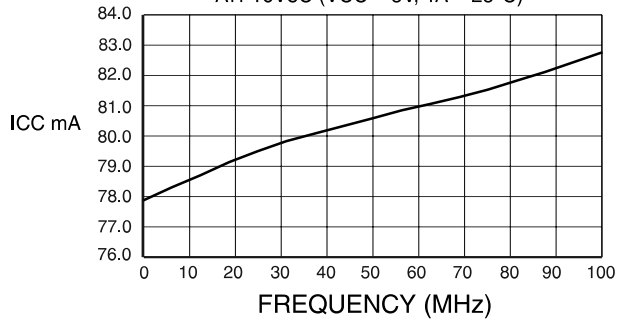

**NORMALIZED SUPPLY CURRENT**  
VS. SUPPLY VOLTAGE  
(TA = 25°C, STANDBY)

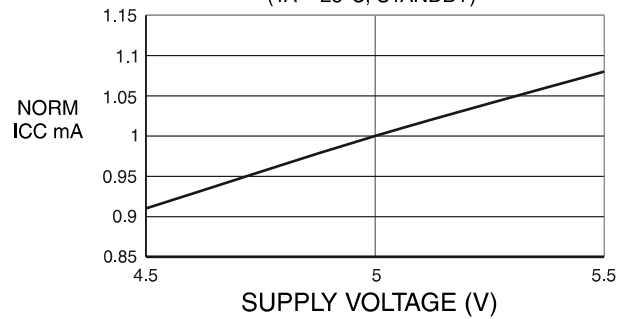

**NORMALIZED SUPPLY CURRENT**  
VS. AMBIENT TEMPERATURE  
(VCC = 5V, STANDBY)

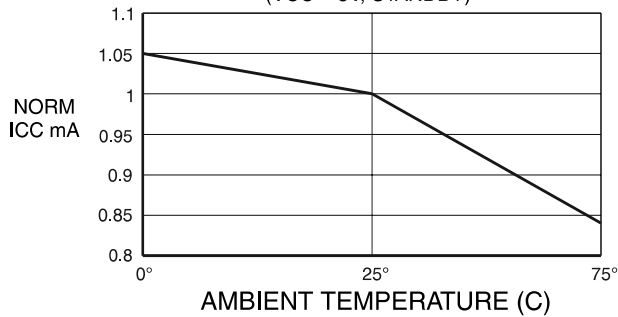

**OUTPUT SOURCE CURRENT**  
VS. SUPPLY VOLTAGE (VOH = 2.4V, TA = 25°C)

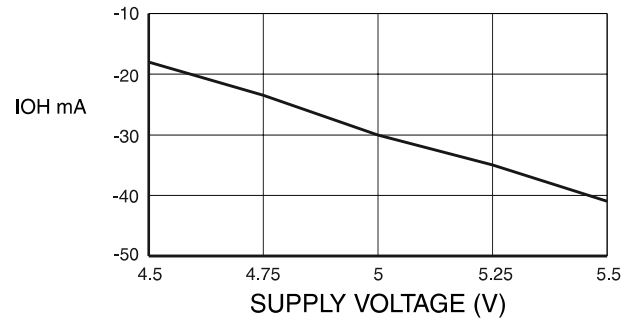

**OUTPUT SINK CURRENT**  
VS. SUPPLY VOLTAGE (TA = 25°C, VOL = 0.45V)

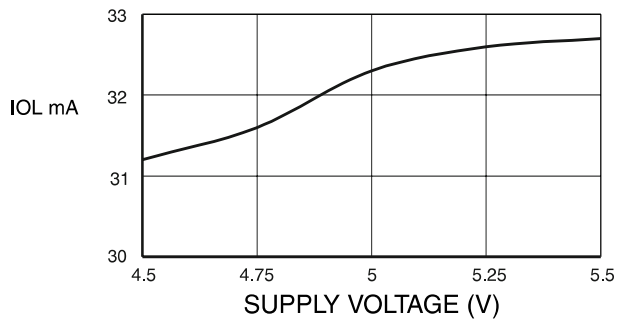

**OUTPUT SOURCE CURRENT**  
VS. OUTPUT VOLTAGE (VCC = 5V, TA = 25°C)

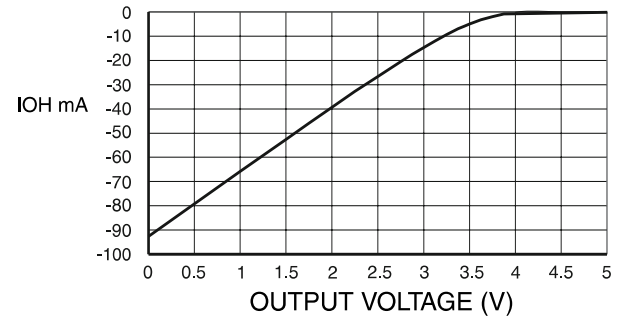

**OUTPUT SINK CURRENT**  
VS. OUTPUT VOLTAGE (VCC = 5V, TA = 25°C)

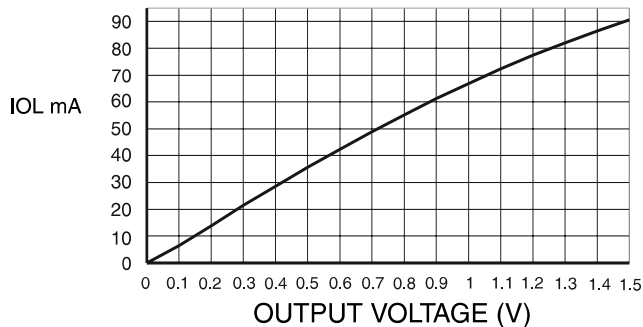

**NORMALIZED  $t_{PD}$**   
VS. SUPPLY VOLTAGE (TA = 25°C)

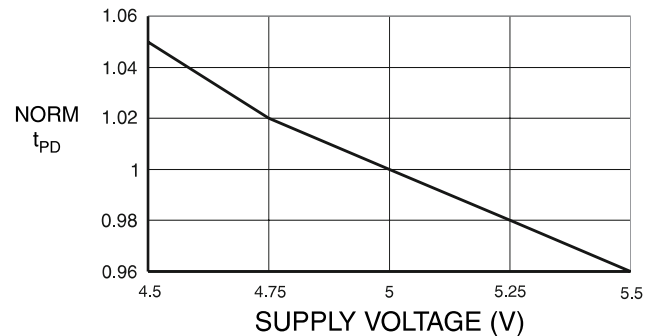

NORMALIZED  $t_{PD}$   
VS. AMBIENT TEMPERATURE (VCC = 5V)

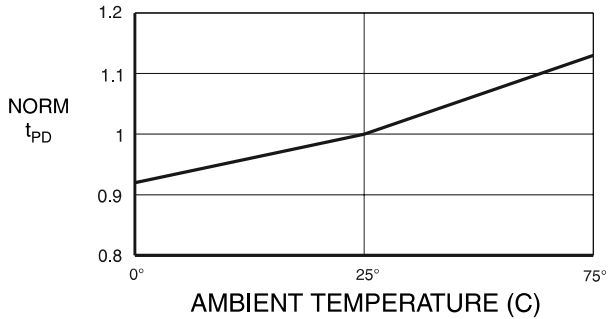

NORMALIZED  $t_{CO}$   
VS. SUPPLY VOLTAGE (TA = 25°C)

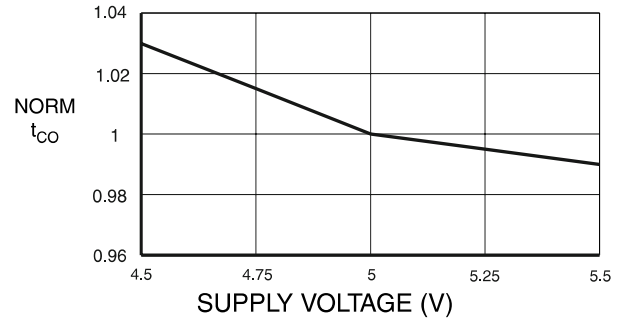

NORMALIZED  $t_{CO}$   
VS. AMBIENT TEMPERATURE (VCC = 5V)

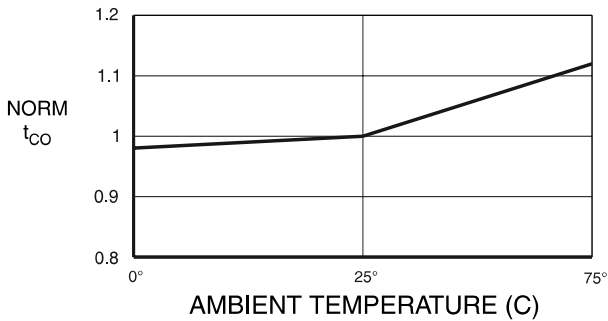

NORMALIZED  $t_S$   
VS. SUPPLY VOLTAGE (TA = 25°C)

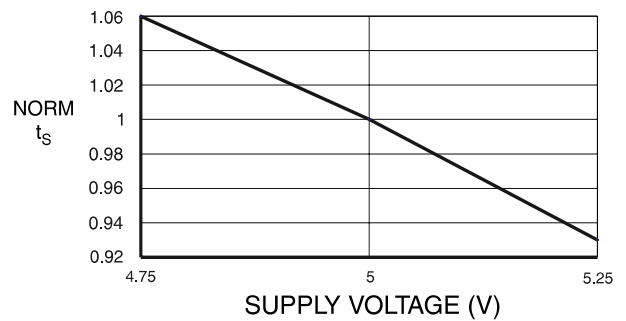

NORMALIZED  $t_S$   
VS. AMBIENT TEMPERATURE (VCC = 5V)

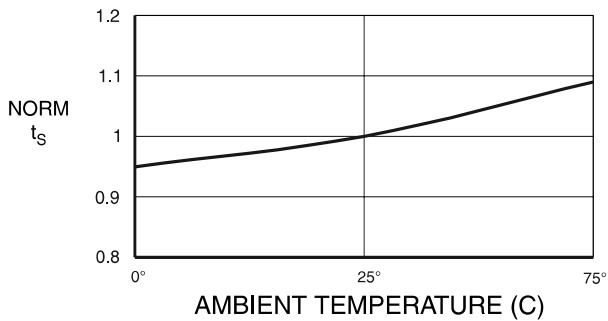

NORMALIZED  $t_H$   
VS. SUPPLY VOLTAGE (TA = 25°C)

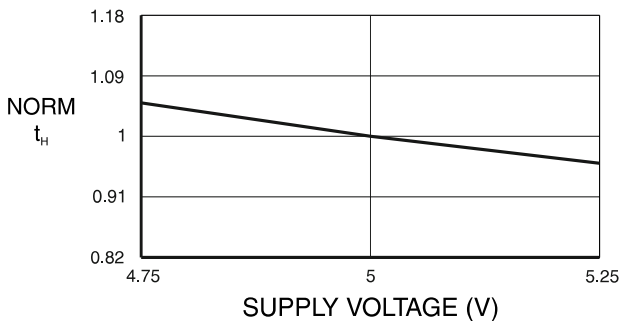

NORMALIZED  $t_H$   
VS. AMBIENT TEMPERATURE (VCC = 5V)

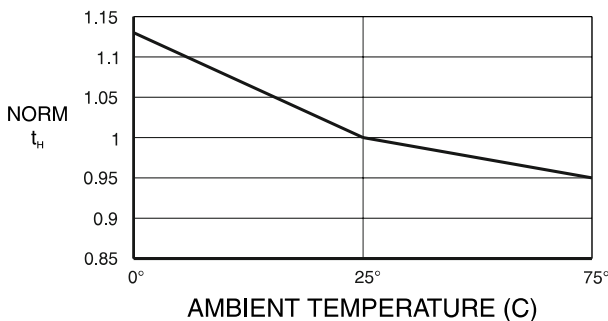

INPUT CLAMP CURRENT  
VS. INPUT VOLTAGE (TA = 25°C, VCC = 5V)

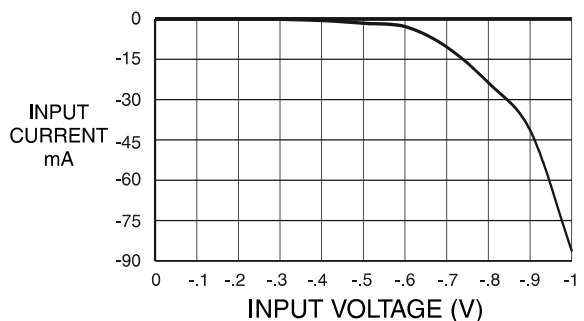

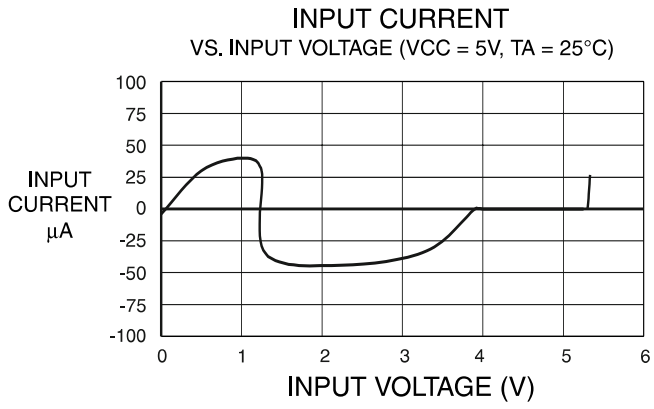

## Ordering Information

$t_{PD}$ (ns)	$t_s$ (ns)	$t_{CO}$ (ns)	Ordering Code	Package	Operation Range
5	3	4	ATF16V8C-5JC	20J	Commercial (0°C to 70°C)
7.5	5	5	ATF16V8C-7JC	20J	Commercial (0°C to 70°C)
			ATF16V8C-7PC	20P3	
			ATF16V8C-7SC	20S	
			ATF16V8C-7XC	20X	
			ATF16V8C-7JI	20J	Industrial (-40°C to 85°C)
			ATF16V8C-7PI	20P3	
			ATF16V8C-7SI	20S	
ATF16V8C-7XI	20X				

### Using “C” Product for Industrial

To use commercial product for Industrial temperature ranges, down-grade one speed grade from the “I” to the “C” device (7 ns “C” = 10 ns “I”) and de-rate power by 30%.

Package Type	
<b>20J</b>	20-lead, Plastic J-leaded Chip Carrier (PLCC)
<b>20P3</b>	20-lead, 0.300" Wide, Plastic Dual Inline Package (PDIP)
<b>20S</b>	20-lead, 0.300" Wide, Plastic Gull-Wing Small Outline (SOIC)
<b>20X</b>	20-lead, 4.4 mm Wide, Plastic Thin Shrink Small Outline (TSSOP)



## Packaging Information

**20J**, 20-lead, Plastic J-leaded Chip Carrier (PLCC)  
Dimensions in Inches and (Millimeters)

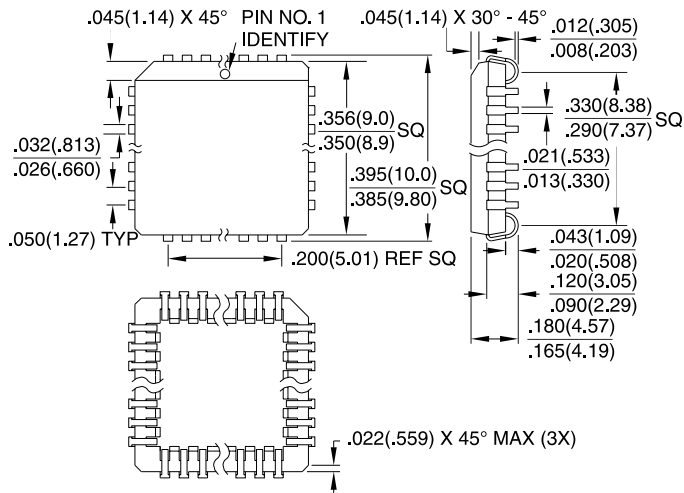

**20P3**, 20-lead, 0.300" Wide,  
Plastic Dual Inline Package (PDIP)  
Dimensions in Inches and (Millimeters)

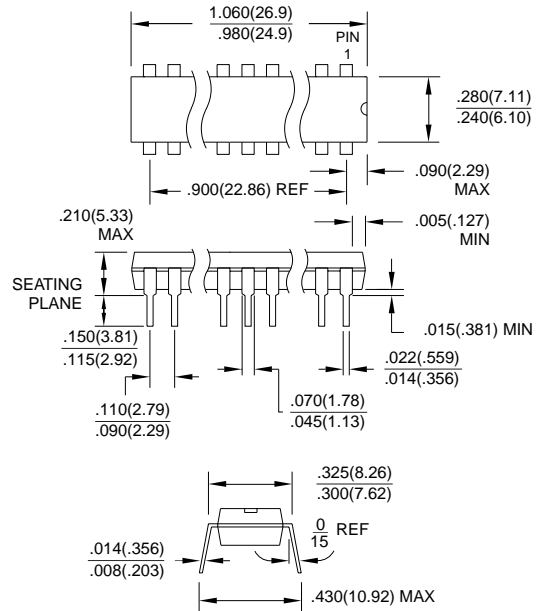

**20S**, 20-lead, 0.300" Wide,  
Plastic Gull-Wing Small Outline (SOIC)  
Dimensions in Inches and (Millimeters)

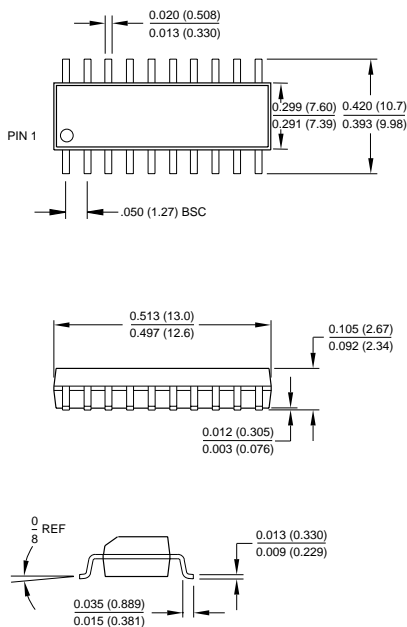

**20X**, 20-lead, 4.4 mm Wide, Plastic Thin Shrink  
Small Outline (TSSOP)  
Dimensions in Millimeters and (Inches)

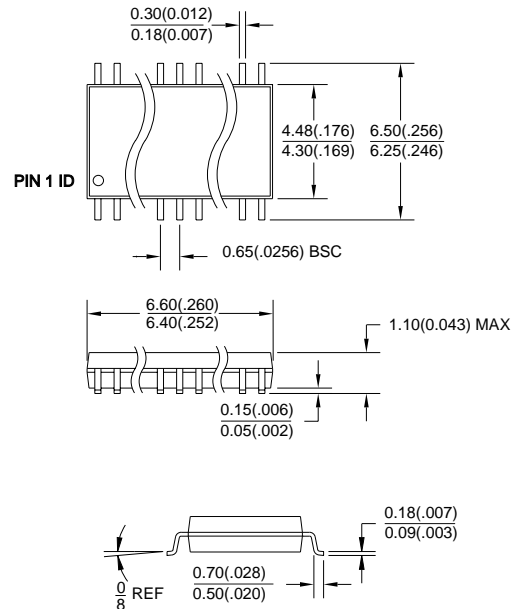



## **Atmel Headquarters**

### ***Corporate Headquarters***

2325 Orchard Parkway  
San Jose, CA 95131  
TEL (408) 441-0311  
FAX (408) 487-2600

### ***Europe***

Atmel U.K., Ltd.  
Coliseum Business Centre  
Riverside Way  
Camberley, Surrey GU15 3YL  
England  
TEL (44) 1276-686-677  
FAX (44) 1276-686-697

### ***Asia***

Atmel Asia, Ltd.  
Room 1219  
Chinachem Golden Plaza  
77 Mody Road Tsimhatsui  
East Kowloon  
Hong Kong  
TEL (852) 2721-9778  
FAX (852) 2722-1369

### ***Japan***

Atmel Japan K.K.  
9F, Tonetsu Shinkawa Bldg.  
1-24-8 Shinkawa  
Chuo-ku, Tokyo 104-0033  
Japan  
TEL (81) 3-3523-3551  
FAX (81) 3-3523-7581

## **Atmel Operations**

### ***Atmel Colorado Springs***

1150 E. Cheyenne Mtn. Blvd.  
Colorado Springs, CO 80906  
TEL (719) 576-3300  
FAX (719) 540-1759

### ***Atmel Rousset***

Zone Industrielle  
13106 Rousset Cedex  
France  
TEL (33) 4-4253-6000  
FAX (33) 4-4253-6001

---

### ***Fax-on-Demand***

North America:  
1-(800) 292-8635  
International:  
1-(408) 441-0732

### ***e-mail***

literature@atmel.com

### ***Web Site***

<http://www.atmel.com>

### ***BBS***

1-(408) 436-4309

#### **© Atmel Corporation 1999.**

Atmel Corporation makes no warranty for the use of its products, other than those expressly contained in the Company's standard warranty which is detailed in Atmel's Terms and Conditions located on the Company's web site. The Company assumes no responsibility for any errors which may appear in this document, reserves the right to change devices or specifications detailed herein at any time without notice, and does not make any commitment to update the information contained herein. No licenses to patents or other intellectual property of Atmel are granted by the Company in connection with the sale of Atmel products, expressly or by implication. Atmel's products are not authorized for use as critical components in life support devices or systems.

Marks bearing ® and/or ™ are registered trademarks and trademarks of Atmel Corporation.

Terms and product names in this document may be trademarks of others.



Printed on recycled paper.

0425G-08/99/xM