

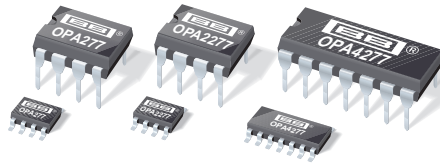

OPA277
OPA2277
OPA4277



For most current data sheet and other product information, visit www.burr-brown.com

High Precision OPERATIONAL AMPLIFIERS

FEATURES

- **ULTRA LOW OFFSET VOLTAGE:** 10 μ V
- **ULTRA LOW DRIFT:** $\pm 0.1\mu$ V/ $^{\circ}$ C
- **HIGH OPEN-LOOP GAIN:** 134dB
- **HIGH COMMON-MODE REJECTION:** 140dB
- **HIGH POWER SUPPLY REJECTION:** 130dB
- **LOW BIAS CURRENT:** 1nA max
- **WIDE SUPPLY RANGE:** ± 2 V to ± 18 V
- **LOW QUIESCENT CURRENT:** 800 μ A/amp
- **SINGLE, DUAL, AND QUAD VERSIONS**
- **REPLACES OP-07, OP-77, OP-177**

APPLICATIONS

- **TRANSDUCER AMPLIFIER**
- **BRIDGE AMPLIFIER**
- **TEMPERATURE MEASUREMENTS**
- **STRAIN GAGE AMPLIFIER**
- **PRECISION INTEGRATOR**
- **BATTERY POWERED INSTRUMENTS**
- **TEST EQUIPMENT**

DESCRIPTION

The OPA277 series precision op amps replace the industry standard OP-177. They offer improved noise, wider output voltage swing, and are twice as fast with half the quiescent current. Features include ultra low offset voltage and drift, low bias current, high common-mode rejection, and high power supply rejection. Single, dual, and quad versions have identical specifications for maximum design flexibility.

OPA277 series op amps operate from ± 2 V to ± 18 V supplies with excellent performance. Unlike most op amps which are specified at only one supply voltage, the OPA277 series is specified for real-world applications; a single limit applies over the ± 5 V to ± 15 V supply range. High performance is maintained as the amplifiers swing to their specified limits. Because the initial offset voltage ($\pm 20\mu$ V max) is so low, user adjustment is usually not required. However, the single version (OPA277) provides external trim pins for special applications.

OPA277 op amps are easy to use and free from phase inversion and overload problems found in some other op amps. They are stable in unity gain and provide excellent dynamic behavior over a wide range of load conditions. Dual and quad versions feature completely independent circuitry for lowest crosstalk and freedom from interaction, even when overdriven or overloaded.

Single (OPA277) and dual (OPA2277) versions are available in 8-pin DIP and SO-8 surface-mount packages. The quad (OPA4277) comes in 14-pin DIP and SO-14 surface-mount packages. All are fully specified from -40° C to $+85^{\circ}$ C and operate from -55° C to $+125^{\circ}$ C.

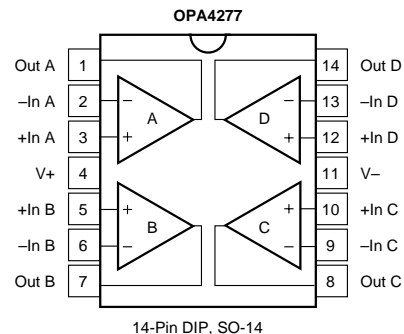
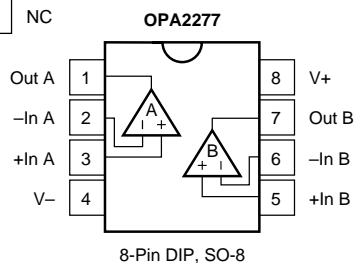
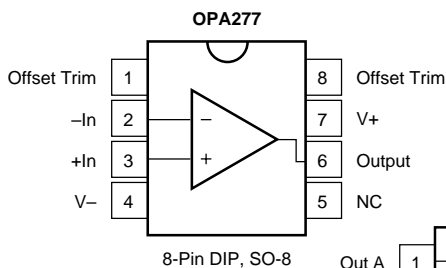

International Airport Industrial Park • Mailing Address: PO Box 11400, Tucson, AZ 85734 • Street Address: 6730 S. Tucson Blvd., Tucson, AZ 85706 • Tel: (520) 746-1111
Twx: 910-952-1111 • Internet: <http://www.burr-brown.com/> • Cable: BBRCORP • Telex: 066-6491 • FAX: (520) 889-1510 • Immediate Product Info: (800) 548-6132

SPECIFICATIONS: $V_S = \pm 5V$ to $V_S = \pm 15V$

At $T_A = +25^\circ C$, and $R_L = 2k\Omega$, unless otherwise noted.

Boldface limits apply over the specified temperature range, $-40^\circ C$ to $+85^\circ C$.

PARAMETER	CONDITION	OPA277P, U OPA2277P, U			OPA277PA, UA OPA2277PA, UA OPA4277PA, UA			UNITS
		MIN	TYP ⁽¹⁾	MAX	MIN	TYP ⁽¹⁾	MAX	
OFFSET VOLTAGE Input Offset Voltage: V_{OS} OPA277P, U (high grade, single) OPA2277P, U (high grade, dual) All PA, UA Versions Input Offset Voltage Over Temperature OPA277P, U (high grade, single) OPA2277P, U (high grade, dual) All PA, UA Versions Input Offset Voltage Drift dV_{OS}/dT OPA277P, U (high grade, single) OPA2277P, U (high grade, dual) All PA, UA Versions Input Offset Voltage: (all models) vs Time vs Power Supply PSRR $T_A = -40^\circ C$ to $+85^\circ C$ Channel Separation (dual, quad)	$T_A = -40^\circ C$ to $+85^\circ C$ $T_A = -40^\circ C$ to $+85^\circ C$ $T_A = -40^\circ C$ to $+85^\circ C$ $T_A = -40^\circ C$ to $+85^\circ C$ $T_A = -40^\circ C$ to $+85^\circ C$ $T_A = -40^\circ C$ to $+85^\circ C$ $V_S = \pm 2V$ to $\pm 18V$ $V_S = \pm 2V$ to $\pm 18V$ dc		± 10 ± 10	± 20 ± 25		± 20	± 50	μV μV μV μV μV $\mu V/^\circ C$ $\mu V/^\circ C$ $\mu V/^\circ C$ $\mu V/mo$ $\mu V/V$ $\mu V/V$ $\mu V/V$
INPUT BIAS CURRENT Input Bias Current I_B $T_A = -40^\circ C$ to $+85^\circ C$ Input Offset Current I_{OS} $T_A = -40^\circ C$ to $+85^\circ C$			± 0.5	± 1 ± 2		*	± 2.8 ± 4	nA nA nA nA
NOISE Input Voltage Noise, $f = 0.1$ to $10Hz$ Input Voltage Noise Density, $f = 10Hz$ e_n $f = 100Hz$ $f = 1kHz$ $f = 10kHz$ Current Noise Density, $f = 1kHz$ i_n			0.22 0.035 12 8 8 8			*	*	$\mu Vp-p$ $\mu Vrms$ nV/ \sqrt{Hz} nV/ \sqrt{Hz} nV/ \sqrt{Hz} nV/ \sqrt{Hz} pA/ \sqrt{Hz}
INPUT VOLTAGE RANGE Common-Mode Voltage Range V_{CM} Common-Mode Rejection CMRR $T_A = -40^\circ C$ to $+85^\circ C$	$V_{CM} = (V-) + 2V$ to $(V+) - 2V$ $V_{CM} = (V-) + 2V$ to $(V+) - 2V$	$(V-) + 2$ 130 128	140	$(V+) - 2$	*	*	*	V dB dB
INPUT IMPEDANCE Differential Common-Mode	$V_{CM} = (V-) + 2V$ to $(V+) - 2V$		100 3 250 3			*	*	M Ω pF G Ω pF
OPEN-LOOP GAIN Open-Loop Voltage Gain A_{OL} $T_A = -40^\circ C$ to $+85^\circ C$	$V_O = (V-) + 0.5V$ to $(V+) - 1.2V$, $R_L = 10k\Omega$ $V_O = (V-) + 0.5V$ to $(V+) - 1.5V$, $R_L = 2k\Omega$ $V_O = (V-) + 0.5V$ to $(V+) - 1.5V$, $R_L = 2k\Omega$	126 134 126	140 134		*	*	*	dB dB dB
FREQUENCY RESPONSE Gain-Bandwidth Product GBW Slew Rate SR Settling Time, 0.1% 0.01% Overload Recovery Time Total Harmonic Distortion + Noise THD+N	$V_S = \pm 15V$, $G = 1$, 10V Step $V_S = \pm 15V$, $G = 1$, 10V Step $V_{IN} \cdot G = V_S$ 1kHz, $G = 1$, $V_O = 3.5Vrms$		1 0.8 14 16 3 0.002			*	*	MHz V/ μs μs μs μs %
OUTPUT Voltage Output V_O $T_A = -40^\circ C$ to $+85^\circ C$ $T_A = -40^\circ C$ to $+85^\circ C$ Short-Circuit Current I_{SC} Capacitive Load Drive C_{LOAD}	$R_L = 10k\Omega$ $R_L = 10k\Omega$ $R_L = 2k\Omega$ $R_L = 2k\Omega$	$(V-) + 0.5$ $(V-) + 0.5$ $(V-) + 1.5$ $(V-) + 1.5$	± 35	$(V+) - 1.2$ $(V+) - 1.2$ $(V+) - 1.5$ $(V+) - 1.5$	*	*	*	V V V V mA
			See Typical Curve			*		

The information provided herein is believed to be reliable; however, BURR-BROWN assumes no responsibility for inaccuracies or omissions. BURR-BROWN assumes no responsibility for the use of this information, and all use of such information shall be entirely at the user's own risk. Prices and specifications are subject to change without notice. No patent rights or licenses to any of the circuits described herein are implied or granted to any third party. BURR-BROWN does not authorize or warrant any BURR-BROWN product for use in life support devices and/or systems.

SPECIFICATIONS: $V_S = \pm 5V$ to $V_S = \pm 15V$ (CONT)

At $T_A = +25^\circ C$, and $R_L = 2k\Omega$, unless otherwise noted.

Boldface limits apply over the specified temperature range, $-40^\circ C$ to $+85^\circ C$.

PARAMETER	CONDITION	OPA277P, U OPA2277P, U			OPA277PA, UA OPA2277PA, UA OPA4277PA, UA			UNITS
		MIN	TYP ⁽¹⁾	MAX	MIN	TYP ⁽¹⁾	MAX	
POWER SUPPLY								
Specified Voltage Range	V_S	± 5		± 15	*		*	V
Operating Voltage Range		± 2		± 18	*		*	V
Quiescent Current (per amplifier)	I_Q		± 790	± 825		*	*	μA
$T_A = -40^\circ C$ to $+85^\circ C$	$I_O = 0$ $I_O = 0$			± 900			*	μA
TEMPERATURE RANGE								
Specified Range		-40		85	*		*	$^\circ C$
Operating Range		-55		125	*		*	$^\circ C$
Storage Range		-55		125	*		*	$^\circ C$
Thermal Resistance	θ_{JA}							$^\circ C/W$
SO-8 Surface-Mount			150			*		$^\circ C/W$
8-Pin DIP			100			*		$^\circ C/W$
14-Pin DIP			80			*		$^\circ C/W$
SO-14 Surface-Mount			100			*		$^\circ C/W$

* Specifications same as OPA277P, U.

NOTE: (1) $V_S = \pm 15V$.

ABSOLUTE MAXIMUM RATINGS⁽¹⁾

Supply Voltage	36V
Input Voltage	(V-) -0.7V to (V+) +0.7V
Output Short-Circuit ⁽²⁾	Continuous
Operating Temperature	$-55^\circ C$ to $+125^\circ C$
Storage Temperature	$-55^\circ C$ to $+125^\circ C$
Junction Temperature	$150^\circ C$
Lead Temperature (soldering, 10s)	$300^\circ C$

NOTE: (1) Stresses above these rating may cause permanent damage. Exposure to absolute maximum conditions for extended periods may degrade device reliability. (2) Short-circuit to ground, one amplifier per package.



ELECTROSTATIC DISCHARGE SENSITIVITY

This integrated circuit can be damaged by ESD. Burr-Brown recommends that all integrated circuits be handled with appropriate precautions. Failure to observe proper handling and installation procedures can cause damage.

ESD damage can range from subtle performance degradation to complete device failure. Precision integrated circuits may be more susceptible to damage because very small parametric changes could cause the device not to meet its published specifications.

PACKAGE/ORDERING INFORMATION

PRODUCT	OFFSET VOLTAGE max, μV	OFFSET VOLTAGE DRIFT max, $\mu V/^\circ C$	PACKAGE	PACKAGE DRAWING NUMBER ⁽¹⁾	TEMPERATURE RANGE	ORDERING NUMBER ⁽²⁾	TRANSPORT MEDIA
Single							
OPA277PA	± 50	± 1	8-Pin DIP	006	$-40^\circ C$ to $+85^\circ C$	OPA277PA	Rails
OPA277P	± 20	± 0.15	8-Pin DIP	006	$-40^\circ C$ to $+85^\circ C$	OPA277P	Rails
OPA277UA	± 50	± 1	SO-8 Surface Mount	182	$-40^\circ C$ to $+85^\circ C$	OPA277UA	Rails
"	"	"	"	"	"	OPA277UA/2K5	Tape and Reel
OPA277U	± 20	± 0.15	SO-8 Surface Mount	182	$-40^\circ C$ to $+85^\circ C$	OPA277U	Rails
"	"	"	"	"	"	OPA277U/2K5	Tape and Reel
Dual							
OPA2277PA	± 50	± 1	8-Pin DIP	006	$-40^\circ C$ to $+85^\circ C$	OPA2277PA	Rails
OPA2277P	± 25	± 0.25	8-Pin DIP	006	$-40^\circ C$ to $+85^\circ C$	OPA2277P	Rails
OPA2277UA	± 50	± 1	SO-8 Surface Mount	182	$-40^\circ C$ to $+85^\circ C$	OPA2277UA	Rails
"	"	"	"	"	"	OPA2277UA/2K5	Tape and Reel
OPA2277U	± 25	± 0.25	SO-8 Surface Mount	182	$-40^\circ C$ to $+85^\circ C$	OPA2277U	Rails
"	"	"	"	"	"	OPA2277U/2K5	Tape and Reel
Quad							
OPA4277PA	± 50	± 1	14-Pin DIP	010	$-40^\circ C$ to $+85^\circ C$	OPA4277PA	Rails
OPA4277UA	± 50	± 1	SO-14 Surface Mount	235	$-40^\circ C$ to $+85^\circ C$	OPA4277UA	Rails
"	"	"	"	"	"	OPA4277UA/2K5	Tape and Reel

NOTE: (1) For detailed drawing and dimension table, please see end of data sheet, or Appendix C of Burr-Brown IC Data Book. (2) Products followed by a slash (/) are only available in Tape and Reel in the quantities indicated (e.g. /2K5 indicates 2500 devices per reel). Ordering 2500 pieces of "OPA277UA/2K5" will get a single 2500 piece Tape and Reel. For detailed Tape and Reel mechanical information, refer to Appendix B of Burr-Brown IC Data Book.

TYPICAL PERFORMANCE CURVES

At $T_A = +25^\circ\text{C}$, $V_S = \pm 15\text{V}$, and $R_L = 2\text{k}\Omega$, unless otherwise noted.

OPEN-LOOP GAIN/PHASE vs FREQUENCY

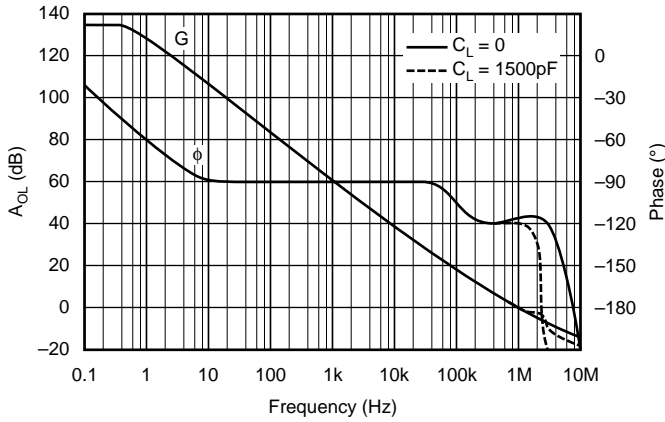

POWER SUPPLY AND COMMON-MODE REJECTION vs FREQUENCY

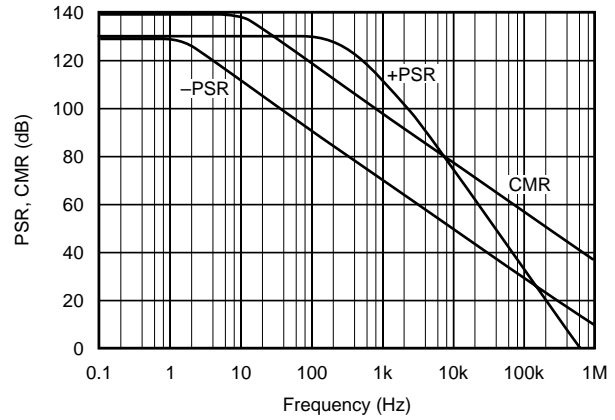

INPUT NOISE AND CURRENT NOISE SPECTRAL DENSITY vs FREQUENCY

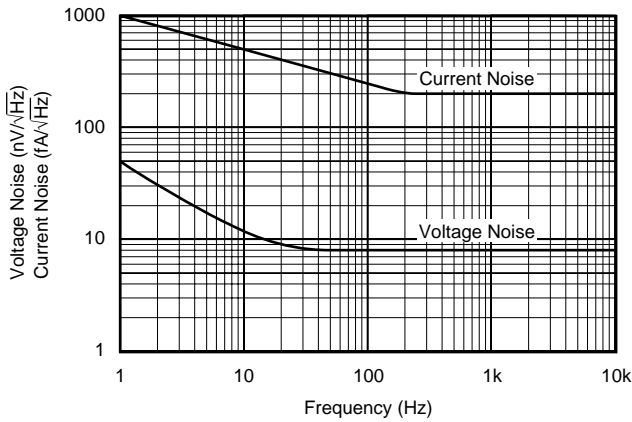

INPUT NOISE VOLTAGE vs TIME

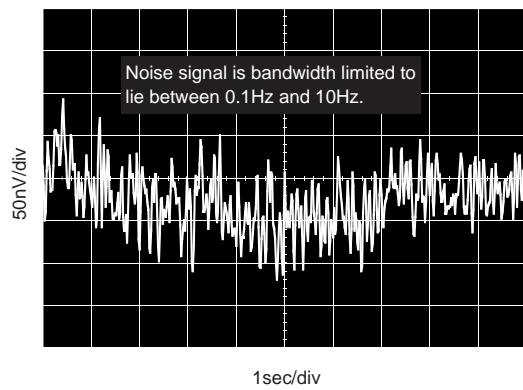

CHANNEL SEPARATION vs FREQUENCY

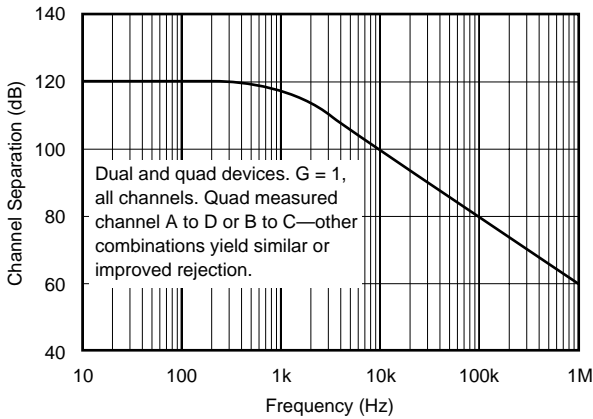

TOTAL HARMONIC DISTORTION + NOISE vs FREQUENCY

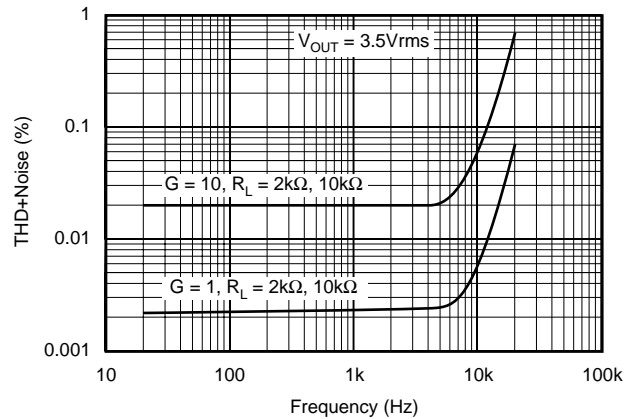

TYPICAL PERFORMANCE CURVES (CONT)

At $T_A = +25^\circ\text{C}$, $V_S = \pm 15\text{V}$, and $R_L = 2\text{k}\Omega$, unless otherwise noted.

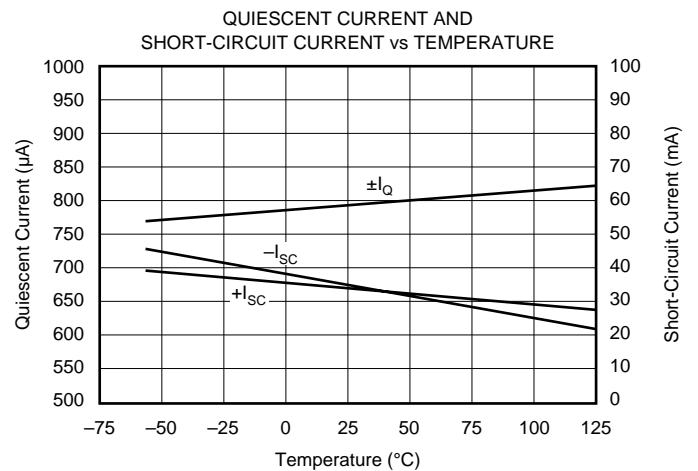
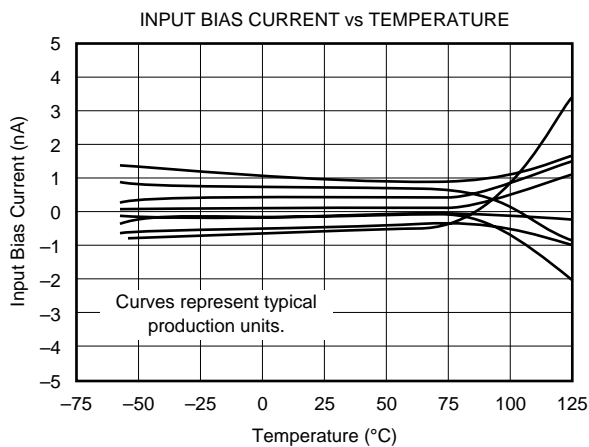
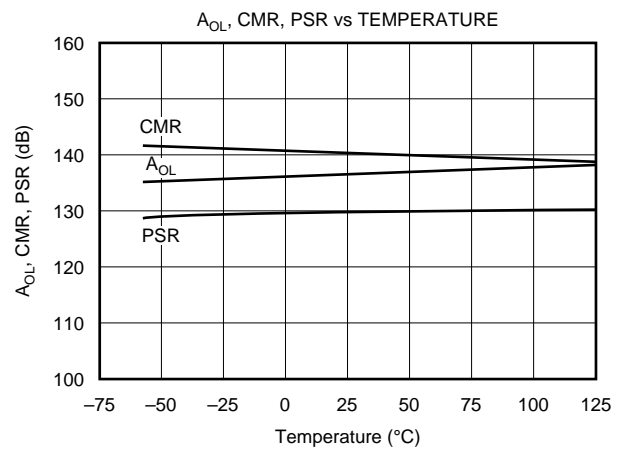
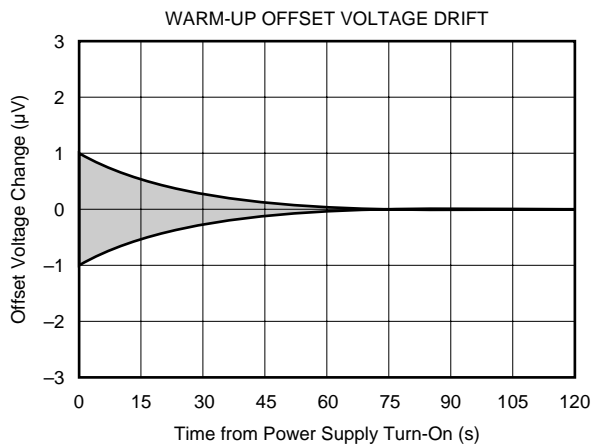
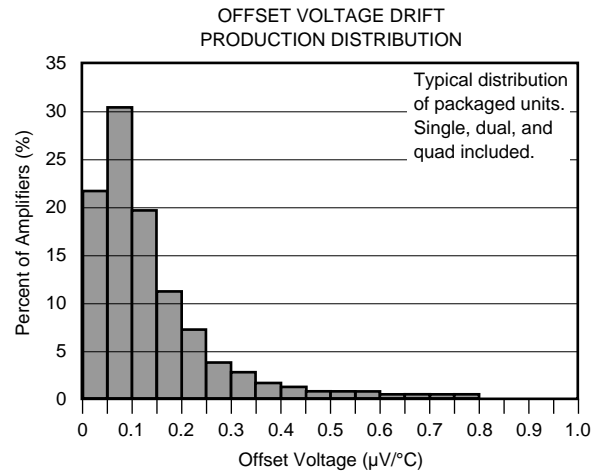
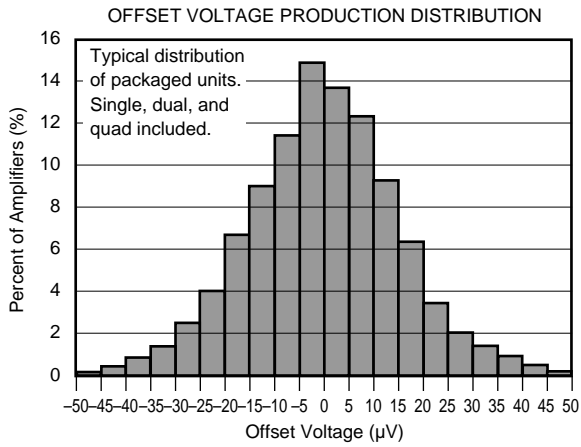

TYPICAL PERFORMANCE CURVES (CONT)

At $T_A = +25^\circ\text{C}$, $V_S = \pm 15\text{V}$, and $R_L = 2\text{k}\Omega$, unless otherwise noted.

CHANGE IN INPUT BIAS CURRENT vs POWER SUPPLY VOLTAGE

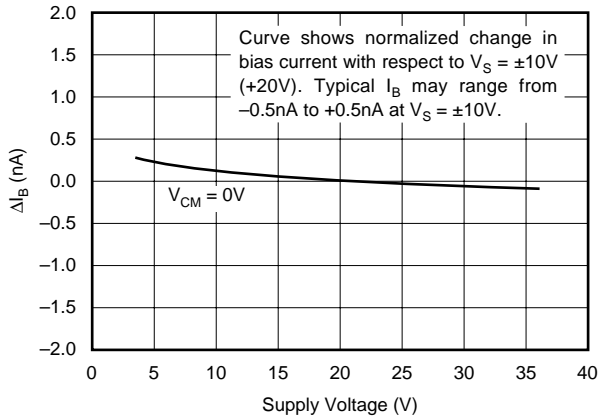

CHANGE IN INPUT BIAS CURRENT vs COMMON-MODE VOLTAGE

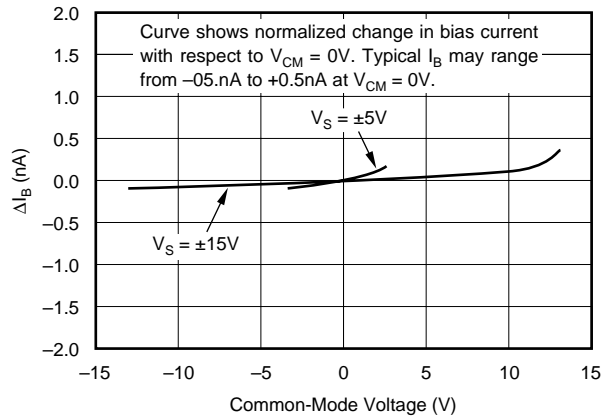

QUIESCENT CURRENT vs SUPPLY VOLTAGE

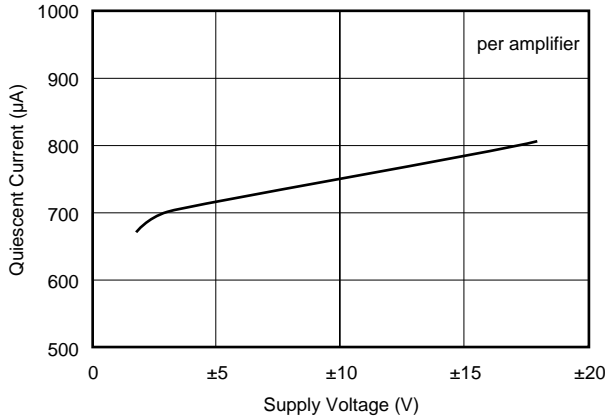

SETTLING TIME vs CLOSED-LOOP GAIN

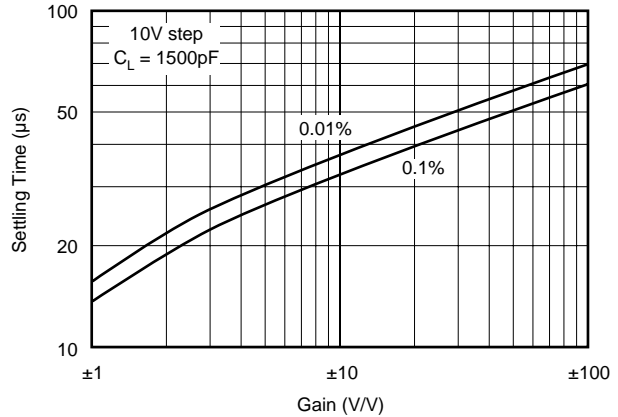

MAXIMUM OUTPUT VOLTAGE vs FREQUENCY

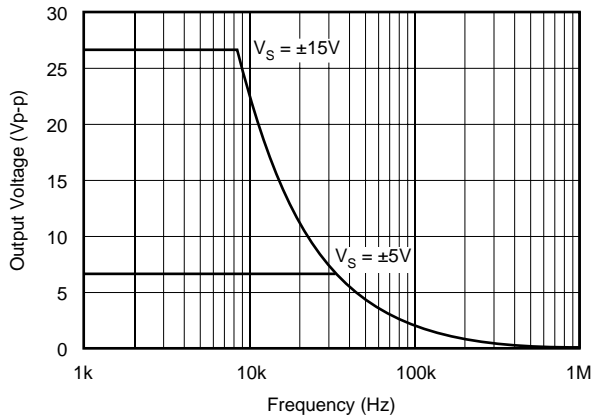

OUTPUT VOLTAGE SWING vs OUTPUT CURRENT

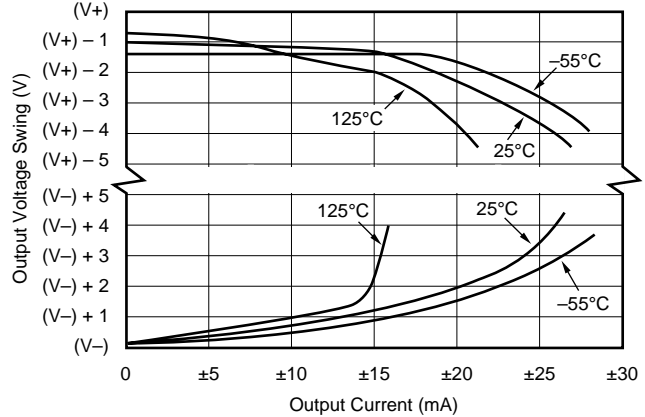

TYPICAL PERFORMANCE CURVES (CONT)

At $T_A = +25^\circ\text{C}$, $V_S = \pm 15\text{V}$, and $R_L = 2\text{k}\Omega$, unless otherwise noted.

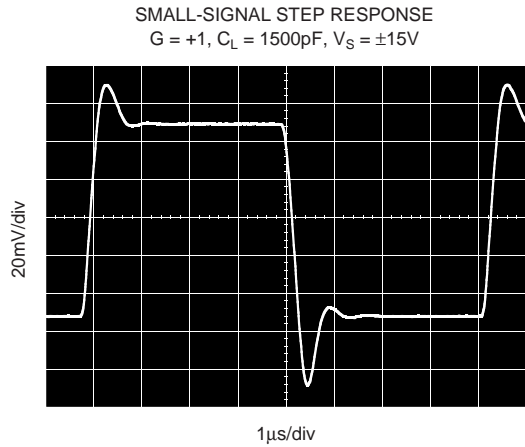
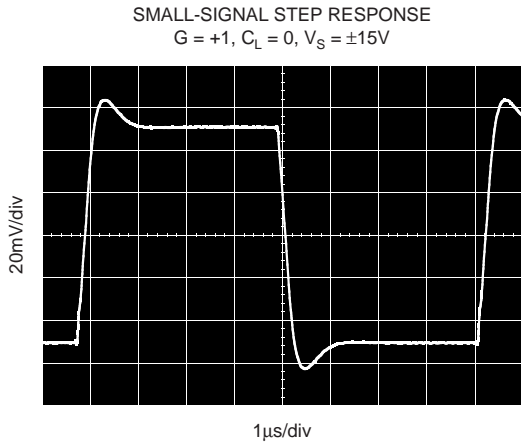
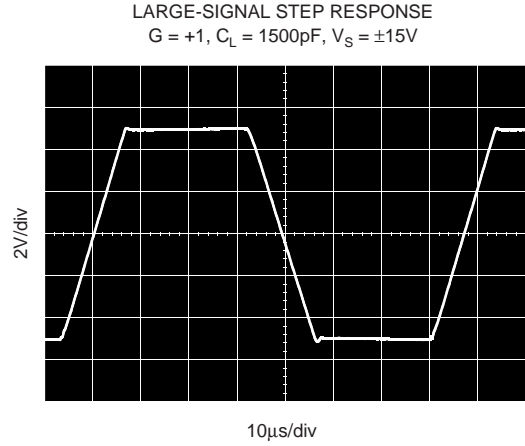
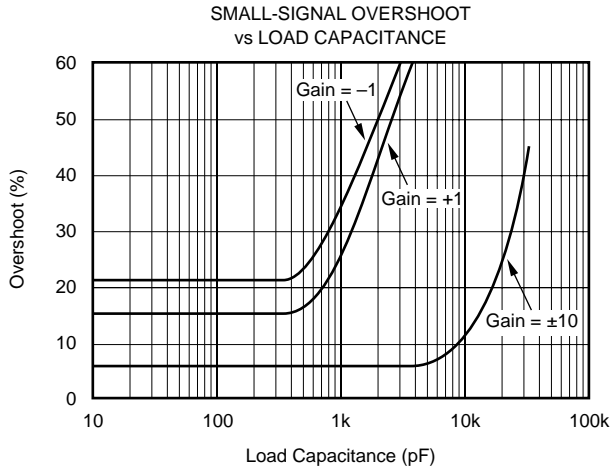

APPLICATIONS INFORMATION

The OPA277 series is unity-gain stable and free from unexpected output phase reversal, making it easy to use in a wide range of applications. Applications with noisy or high impedance power supplies may require decoupling capacitors close to the device pins. In most cases 0.1µF capacitors are adequate.

The OPA277 series has very low offset voltage and drift. To achieve highest performance, circuit layout and mechanical conditions should be optimized. Offset voltage and drift can be degraded by small thermoelectric potentials at the op amp inputs. Connections of dissimilar metals will generate thermal potential which can degrade the ultimate performance of the OPA277 series. These thermal potentials can be made to cancel by assuring that they are equal in both input terminals.

- Keep thermal mass of the connections made to the two input terminals similar.
- Locate heat sources as far as possible from the critical input circuitry.
- Shield op amp and input circuitry from air currents such as cooling fans.

OPERATING VOLTAGE

OPA277 series op amp operate from ±2V to ±18V supplies with excellent performance. Unlike most op amps which are specified at only one supply voltage, the OPA277 series is specified for real-world applications; a single limit applies over the ±5V to ±15V supply range. This allows a customer operating at $V_S = \pm 10V$ to have the same assured performance as a customer using ±15V supplies. In addition, key parameters are guaranteed over the specified temperature range, -40°C to +85°C. Most behavior remains unchanged through the full operating voltage range (±2V to ±18V). Parameters which vary significantly with operating voltage or temperature are shown in typical performance curves.

OFFSET VOLTAGE ADJUSTMENT

The OPA277 series is laser-trimmed for very low offset voltage and drift so most circuits will not require external adjustment. However, offset voltage trim connections are provided on pins 1 and 8. Offset voltage can be adjusted by

connecting a potentiometer as shown in Figure 1. This adjustment should be used only to null the offset of the op amp. This adjustment should not be used to compensate for offsets created elsewhere in a system since this can introduce additional temperature drift.

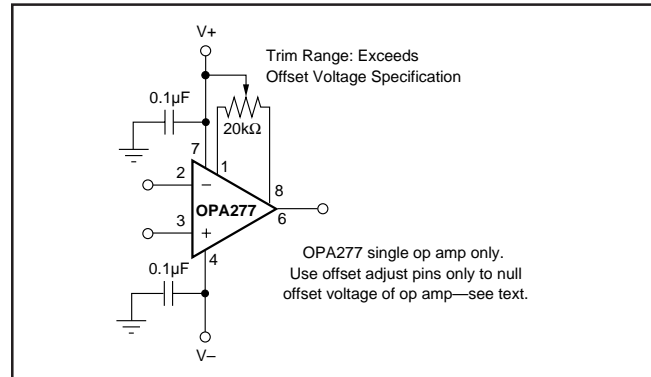

FIGURE 1. OPA277 Offset Voltage Trim Circuit.

INPUT PROTECTION

The inputs of the OPA277 series are protected with 1kΩ series input resistors and diode clamps. The inputs can withstand ±30V differential inputs without damage. The protection diodes will, of course, conduct current when the inputs are over-driven. This may disturb the slewing behavior of unity-gain follower applications, but will not damage the op amp.

INPUT BIAS CURRENT CANCELLATION

The input stage base current of the OPA277 series is internally compensated with an equal and opposite cancellation circuit. The resulting input bias current is the difference between the input stage base current and the cancellation current. This residual input bias current can be positive or negative.

When the bias current is canceled in this manner, the input bias current and input offset current are approximately the same magnitude. As a result, it is not necessary to use a bias current cancellation resistor as is often done with other op amps (Figure 2). A resistor added to cancel input bias current errors may actually increase offset voltage and noise.

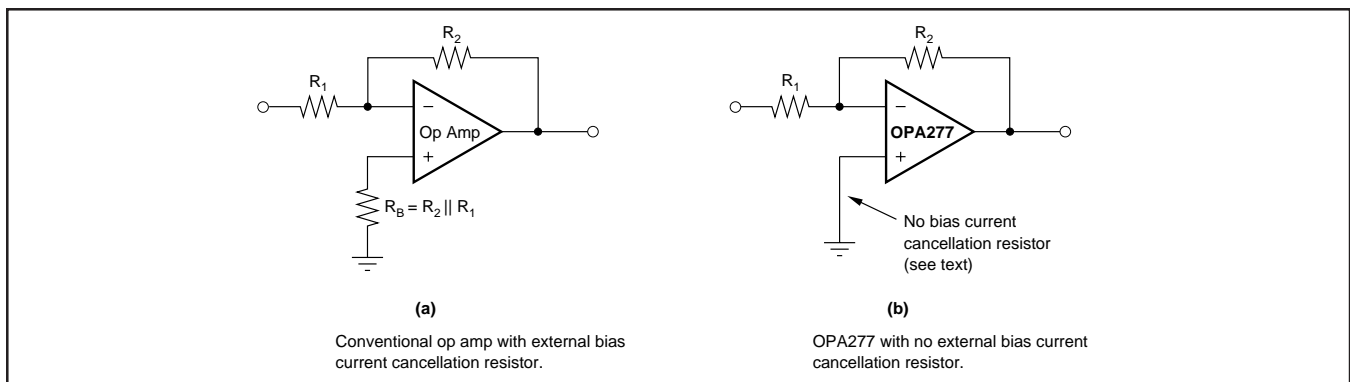

FIGURE 2. Input Bias Current Cancellation.

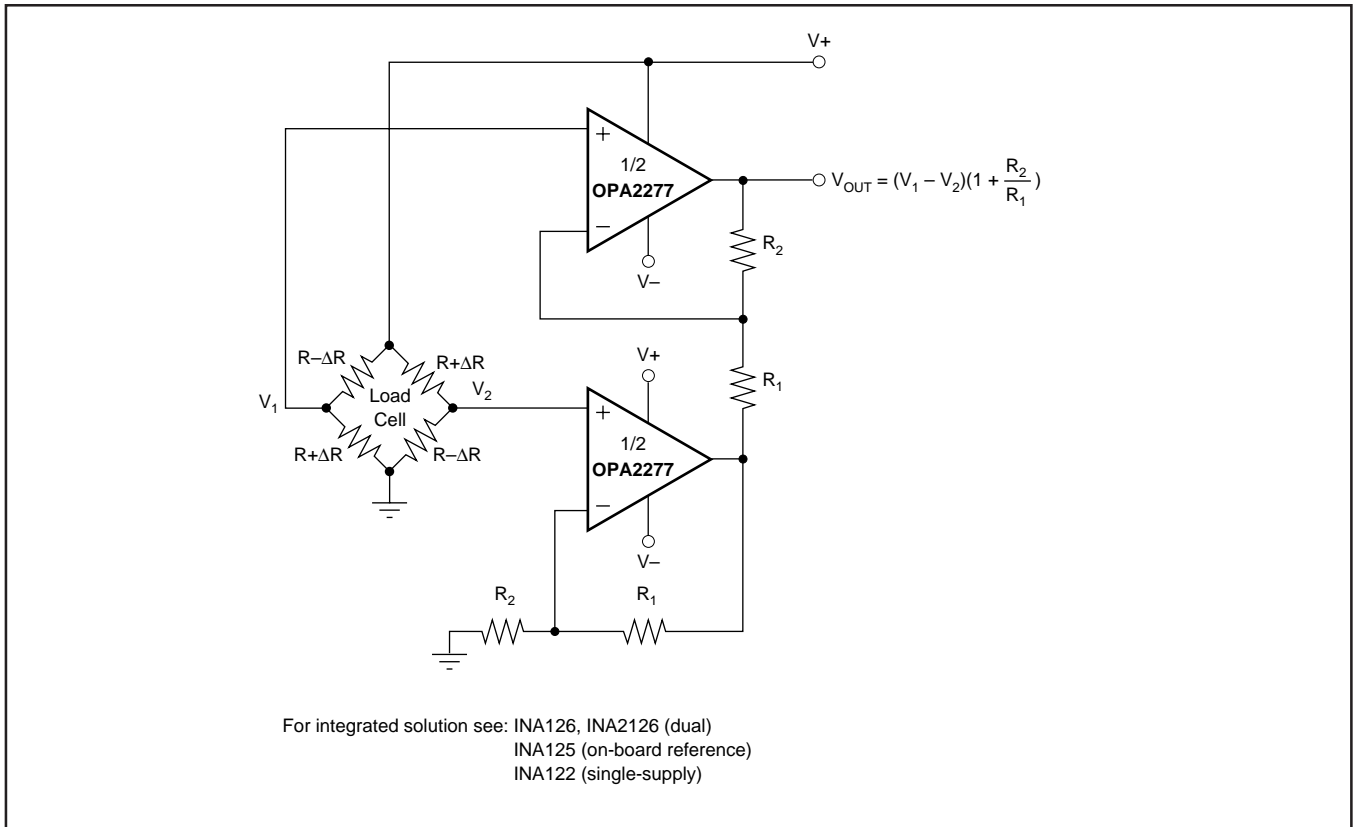

FIGURE 3. Load Cell Amplifier.

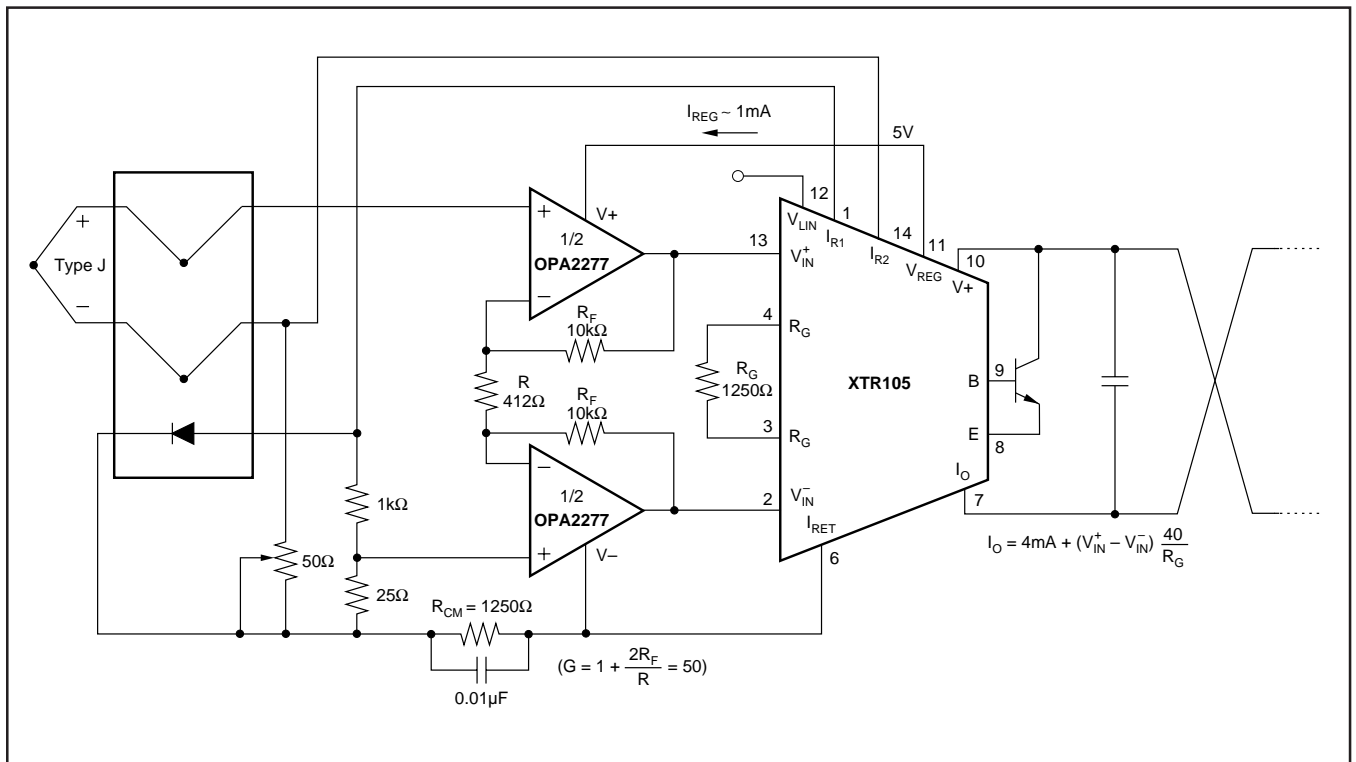

FIGURE 4. Thermocouple Low Offset, Low Drift Loop Measurement with Diode Cold Junction Compensation.

PACKAGING INFORMATION

ORDERABLE DEVICE	STATUS(1)	PACKAGE TYPE	PACKAGE DRAWING	PINS	PACKAGE QTY
OPA2277P	ACTIVE	PDIP	P	8	50
OPA2277PA	ACTIVE	PDIP	P	8	50
OPA2277U	ACTIVE	SOIC	D	8	100
OPA2277U/2K5	ACTIVE	SOIC	D	8	2500
OPA2277UA	ACTIVE	SOIC	D	8	100
OPA2277UA/2K5	ACTIVE	SOIC	D	8	2500
OPA277P	ACTIVE	PDIP	P	8	50
OPA277PA	ACTIVE	PDIP	P	8	50
OPA277U	ACTIVE	SOIC	D	8	100
OPA277U/2K5	ACTIVE	SOIC	D	8	2500
OPA277UA	ACTIVE	SOIC	D	8	100
OPA277UA/2K5	ACTIVE	SOIC	D	8	2500
OPA4277PA	ACTIVE	PDIP	N	14	25
OPA4277UA	ACTIVE	SOIC	D	14	58
OPA4277UA/2K5	ACTIVE	SOIC	D	14	2500

(1) The marketing status values are defined as follows:

ACTIVE: Product device recommended for new designs.

LIFEBUY: TI has announced that the device will be discontinued, and a lifetime-buy period is in effect.

NRND: Not recommended for new designs. Device is in production to support existing customers, but TI does not recommend using this part in a new design.

PREVIEW: Device has been announced but is not in production. Samples may or may not be available.

OBSOLETE: TI has discontinued the production of the device.

IMPORTANT NOTICE

Texas Instruments Incorporated and its subsidiaries (TI) reserve the right to make corrections, modifications, enhancements, improvements, and other changes to its products and services at any time and to discontinue any product or service without notice. Customers should obtain the latest relevant information before placing orders and should verify that such information is current and complete. All products are sold subject to TI's terms and conditions of sale supplied at the time of order acknowledgment.

TI warrants performance of its hardware products to the specifications applicable at the time of sale in accordance with TI's standard warranty. Testing and other quality control techniques are used to the extent TI deems necessary to support this warranty. Except where mandated by government requirements, testing of all parameters of each product is not necessarily performed.

TI assumes no liability for applications assistance or customer product design. Customers are responsible for their products and applications using TI components. To minimize the risks associated with customer products and applications, customers should provide adequate design and operating safeguards.

TI does not warrant or represent that any license, either express or implied, is granted under any TI patent right, copyright, mask work right, or other TI intellectual property right relating to any combination, machine, or process in which TI products or services are used. Information published by TI regarding third-party products or services does not constitute a license from TI to use such products or services or a warranty or endorsement thereof. Use of such information may require a license from a third party under the patents or other intellectual property of the third party, or a license from TI under the patents or other intellectual property of TI.

Reproduction of information in TI data books or data sheets is permissible only if reproduction is without alteration and is accompanied by all associated warranties, conditions, limitations, and notices. Reproduction of this information with alteration is an unfair and deceptive business practice. TI is not responsible or liable for such altered documentation.

Resale of TI products or services with statements different from or beyond the parameters stated by TI for that product or service voids all express and any implied warranties for the associated TI product or service and is an unfair and deceptive business practice. TI is not responsible or liable for any such statements.

Following are URLs where you can obtain information on other Texas Instruments products and application solutions:

Products		Applications	
Amplifiers	amplifier.ti.com	Audio	www.ti.com/audio
Data Converters	dataconverter.ti.com	Automotive	www.ti.com/automotive
DSP	dsp.ti.com	Broadband	www.ti.com/broadband
Interface	interface.ti.com	Digital Control	www.ti.com/digitalcontrol
Logic	logic.ti.com	Military	www.ti.com/military
Power Mgmt	power.ti.com	Optical Networking	www.ti.com/opticalnetwork
Microcontrollers	microcontroller.ti.com	Security	www.ti.com/security
		Telephony	www.ti.com/telephony
		Video & Imaging	www.ti.com/video
		Wireless	www.ti.com/wireless

Mailing Address: Texas Instruments
Post Office Box 655303 Dallas, Texas 75265

Copyright © 2003, Texas Instruments Incorporated